

**LED/Connector pin identification table**

Connector	PIN	LABEL	LED	Connector	PIN	LABEL	LED
2.5mm, 3.5mm & 6.35mm	sleeve	ground	1	4mm Banana	Black	ground	1
Mono/Stereo Jacks	tip	hot	2		Red	Signal	2
	ring	cold	3	8 pole Speakon	1+		1
3,4,5 pole XLR Male & Female	1	ground	1		1-		2
	2	hot	2		2+		3
	3	cold	3		2-		4
	4		4		3+		5
	5		5		3-		6
	shell		screen		4+		7
3,5 & 8 pole 180° DIN	1	ground	1		4-		8
	2		2	RJ45/EtherCon	1		1
	3		3		2		2
	4		4		3		3
	5		5		4		4
	6		6		5		5
	7		7		6		6
	8		8		7		7
	shell		screen		8		8
USB A & B &	1		1		screen		screen
MINI DIN 4	2		2	RCA Phono &	screen	screen	1
pole / S-Video	3		3	BNC	inner	inner	2
	4		4	Powercon in	earth	earth	1
	screen		screen	and out	L	live	2
					N	neutral	3

# AudioJoG® Pro 8power Operations Manual

## Introduction

The AudioJoG® Pro 8power Cable Tester is a versatile unit that allows the user to either identify the connections within a variety of Professional Audio, Lighting & digital Network cables. Or carry out rapid comparison tests having stored known good cable details. Now with intermittent fault finding. Cables fitted with any of the following connectors may be checked:

- 3, 4 & 5 Pole XLR Male or Female
- 6.35mm Jack, stereo or mono
- 2.5mm Jack, stereo or mono
- 3.5mm Jack, stereo or mono
- 2,4 & 8 Pole Speakon (™)
- USB A & B
- RJ45 EtherCon(™)
- DIN 180° 3, 5 & 8 Pole
- MINI DIN 4 Pole
- RCA Phono
- BNC
- 4mm (x2)
- Powercon(™) in and out

The AudioJoG® Pro 8power Cable Tester allows you to visually test for the following conditions:

- Continuity
- Short Circuits (end to end & between unconnected pins)
- Open Circuits (end to end & between unconnected pins)
- Crossed Wires

The AudioJoG® Pro 8power Cable Tester has five modes of operation:

- 1. Manual, double ended - both ends of the cable under test plugged into AudioJoG® Pro 8power
- 2. Automatic, double ended - both ends of the cable under test plugged into AudioJoG® Pro 8power using the MEMORY feature.
- 3. Automatic, double ended intermittent - both ends of the cable under test plugged into AudioJoG® Pro 8power using the MEMORY feature.
- 4. Manual, single ended - one end of the cable under test plugged into AudioJoG® Pro 8power the other into another AudioJoG®, testing can be from either end.
- 5. Automatic, single ended - one end of the cable under test plugged into AudioJoG® Pro 8power the other into another AudioJoG®, testing can be from either end using the MEMORY feature.
- Less than 2 seconds test time

**Please read the following instructions carefully before using the AudioJoG® Pro 8power Cable Tester.**

### Warning:

**The Cables to be tested must be fully disconnected from any other equipment or electrical source. Failure to do so could result in electrical shock and permanent damage to the AudioJoG® Pro 8power Cable Tester,**

## Getting started

The AudioJoG® Pro 8power Cable Tester will require fitting of a 9 volt battery ( not supplied) or fitting the 9v PSU adaptor available as an accessory. Using a screwdriver to undo the screw holding the small panel on the right of the tester to gain access to the battery compartment. Fit the 9 volt PP3 battery observing correct polarity.

### Batteries / Power Down:

Under normal use the batteries should give at least a years use. The AudioJoG® Pro 8power will indicate that battery power is getting low by flashing the TEST button LED. Replace the battery as soon as possible to maintain accurate test results. The low power indicator is not available when the unit is set to Remote mode.

## Test Procedure

There are 2 rows of 9 Light Emitting Diodes (LED's) corresponding to each of the 8 possible connector pins and one for the screen (or shield) connection. Checking the status of connections is made using the TEST button. Until you become familiar with the connectors pin wiring you may wish to refer to the handy LED/Connector Identification table on the back page.

## METHOD 5 - Automatic Single Ended (Continued)

a) A short was found, between wires 2 and 4 (Fig20).

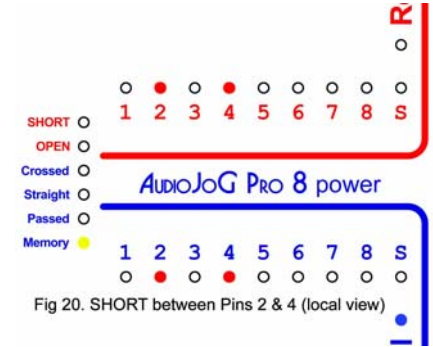

8. Press the TEST button to proceed, if there are more failures the test will stop at each and everyone of them, finally only the FAILED and MEMORY LED's will be ON.To test another cable repeat steps 3 & 4. To clear the MEMORY option either, switch OFF and then ON again or, press and hold the test button until the MEMORY LED goes OFF.

### DECLARATION OF CONFORMITY

**Manufacturers Name:** CableJoG Ltd.  
**Address:** 18 Browmere Drive, Croft,  
 Warrington. WA3 7HT.  
**Declare that;**



**Product:** AudioJoG Pro 8power

#### conforms to the following Product Specification:

BS EN 61000-6-3 for Generated Emissions  
 BS EN 61000-6-1 for Immunity to Radiated Electromagnetic Fields  
 Immunity to Fast Transient Bursts - Signal Lines  
 Immunity to Conducted Field - Signal Lines  
 Immunity to Electrostatic Discharge

The product herewith complies with the requirement of the EMC Directive 89/336/EC.

RoHS+WEEE



## METHOD 5 - Automatic Single Ended

Like the previous method this uses two AudioJoG® Pro 8power cable testers. As with the process of going from Manual to Automatic Double ended testing, the start of the Automatic testing is the completion of the Manual test ending on the 'local' screen LED, normally when the "S" Remote LED is lit.

1. Once again at the 'local' screen LED on position press and hold until the MEMORY LED lights (Fig17).
2. After a few seconds (if there are unconnected pins then this will increase the test time) the display should show the Pass (green) and MEMORY (Yellow) LED's. If the Fail LED is on then there is probably an intermittent connection in the cable.

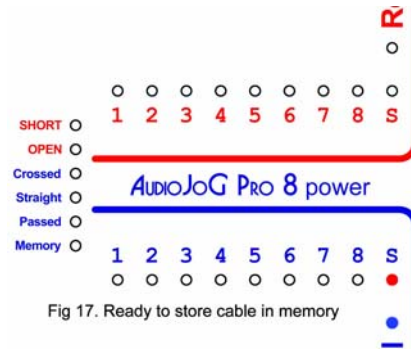

3. Plug in the cable to be tested using the same connector(s) and locations as before.

4. Press and release the TEST button. If all is well the Pass LED will turn ON, remove the cable. To test another cable repeat steps 3 & 4.

5. To clear the MEMORY either, switch OFF and then ON again or, press and hold the test button until the MEMORY LED goes OFF.

6. If the OPEN LED turns ON, then the AudioJoG® Pro 8power has found a missing connection between the cable details in memory and the current cable. The numbered and screen LED's will stop at the error stage (Fig18).

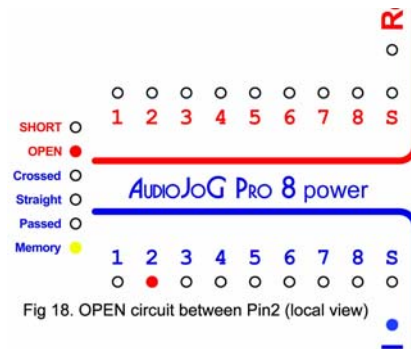

7. If the SHORT LED turns ON, then the AudioJoG® Pro 8power has found an extra connection between the cable details in memory and the current cable. The numbered and screen LED's will stop at the error stage (Fig19).

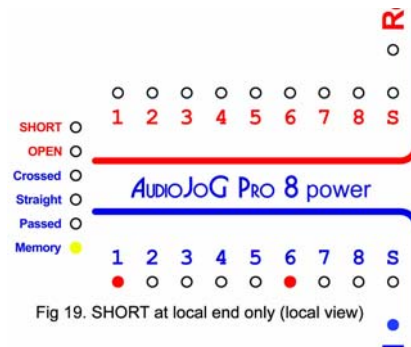

## METHOD 1 - Manual Double Ended

This is the preferred method for testing a cable that is different to the previously tested one and has both ends available for plugging into the AudioJoG® Pro 8power.



1. Switch ON.

After a brief random display, The LED's should turn ON and OFF starting with the Blue Local LED and ending at the RED Remote LED after which the TEST button LED will turn on. If this is not the case then please check the power and mains connections, otherwise return the AudioJoG® Pro 8power for repair. If the TEST button LED starts to flash then the battery power is low and testing long cables is not advised until the battery is replaced.

2. Plug one end of the cable to be tested into an appropriate socket using the 'Local' half of the tester.

3. Plug the other end of the cable into an appropriate connector using the 'Remote' half of the tester.

## METHOD 1 - Manual Double Ended (Continued)

4. To start the test press and release the TEST button. On the lower row of LED's the No1 LED will turn ON,

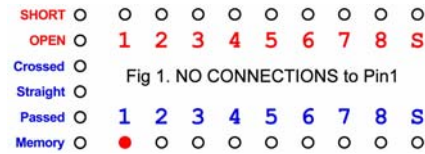

A single LED ON indicates that there are no connections to that pin (Fig1).

Two or more LED's ON (either row) indicate the connection from PIN 1 of the connector plugged into the local half to the remote half of the tester (Fig2).

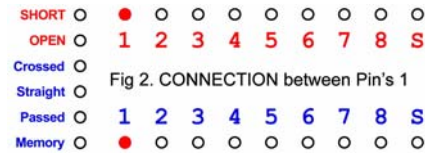

5. Press and release the TEST button again, the current LED's will go out.

If there were no connections in previous step then the upper LED No1 will turn ON (Fig3).

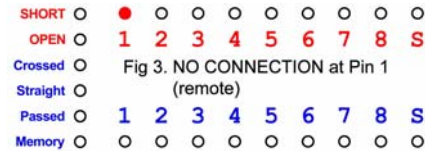

Or if there were connections in the previous step then the local No2 LED will turn ON (Fig4).

As before if there are any other LED's ON (either row) then they indicate the connection from the PIN 2 of the connector plugged into the local half of the tester.

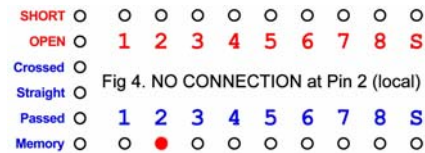

Repeat step 5 until the Remote or both SCREEN LED turn ON (Fig5).

This is the end point for the visual test procedure, AudioJoG® Pro 8power can not decide for you whether the results are correct or not.

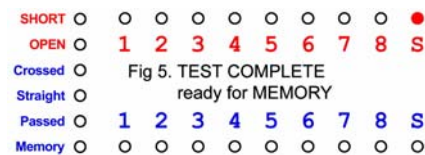

## METHOD 4 - Manual Single Ended (Continued)

1. Set up the Remote end first by pressing and holding the Test button whilst switching the tester on. Plug the cable under test in the appropriate socket on the 'Remote' side of the unit.

2. When you see only the Remote and Local LED's still on release the Test button.

3. The Remote LED will go out. Pressing the Test button now switches between Local and Remote.

4. Select remote, then press and hold the Test button until the remote LED goes out.

5. Release the Test button. The tester is now ready to receive and send information to the Local unit.

6. Set up the Local end by pressing and holding the Test button whilst switching the tester on. Plug the cable under test in the appropriate socket on the 'Local' side of the unit.

7. Release the Test button, the remote LED will go out.

8. The Local LED should be on. Press the Test button again and release it as soon as Pin 2 on the local side starts sending information to the other end, this is indicated by the LED flashing. Pin 1 is not tested as it is essential for communications between the two testers. If there is a connection to Pin 2 at the other end then the result will be seen at the Remote side of the Local unit and Pin 2 will light on the Local and Remote's sides at the Remote end (Fig 15 & 16).

9. Press and release the Test button, the test pin will move onto the next one.

10. Repeat step 8 until the local screen LED is lit.

This is the end point for the visual test procedure, AudioJoG® Pro 8power can not decide for you whether the results are correct or not. If the cable checked matches, either a digital straight through, or a digital cross over the the corresponding green Straight/Crossed LED will light.

Then either:-

Press and release the TEST button to clear the display and take you back to step 6.

Or see next chapter for how to automatically test cables against details held in memory.

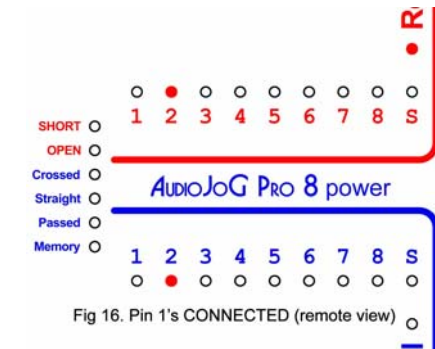
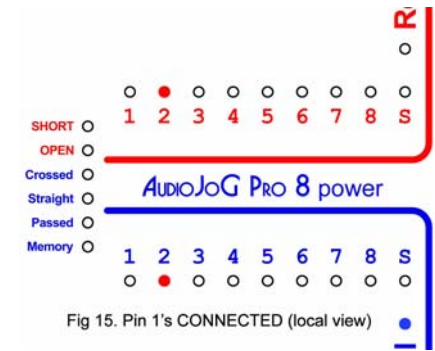

### METHOD 3 - Automatic Double Ended Intermittent

This method continuously tests the cable against the details held in memory until a difference is found.

1. Follow the Method 1 and 2 instructions until the last completed stage the PASSED LED should be lit and maybe either, depending on the cable under test, the STRAIGHT or CROSSED LED.

2. Press and hold the Test button until the MEMORY (yellow) LED starts to flash.

3. Releasing the Test button will cause the tester to run through all the connections continuously until a fault is found all the LED's will glow (Fig 14). Please note there is no battery saving feature in this method and prolonged use will shorten the battery life.

4. After a fault is found and displayed the tester goes back to method 2 and once again the cable will have to pass this before intermittent testing can be carried out.

5. To go back to method 1 testing hold the TEST button down until all the LED's go out (about three seconds).

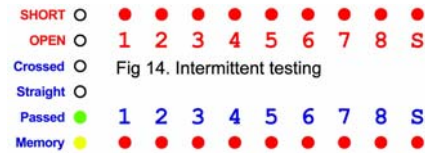

### METHOD 4 - Manual Single Ended

This method uses two AudioJoG cable testers, one at each end of the cable. One unit is set to 'Remote' the other to 'Local', testing is carried at the 'Local' end This method of test ONLY WORKS IF THERE IS A GOOD **Ground or Pin1** CONNECTION BETWEEN THE TWO CABLE ENDS.

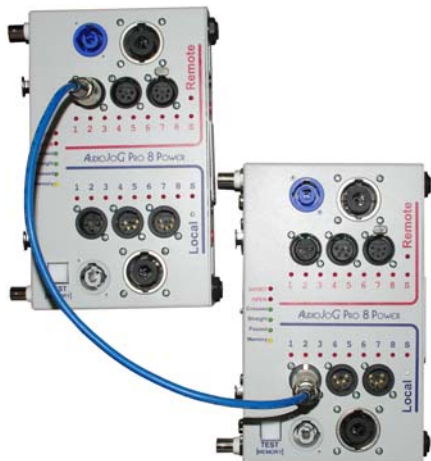

### METHOD 1 - Manual Double Ended (Continued)

If all 8 signal pins are connected similarly, one to one, two to two etc then the green Straight LED will light.

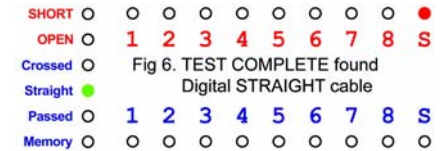

If all 8 signal pins are connected in the digital network crossover standard then the green Crossed LED will light.

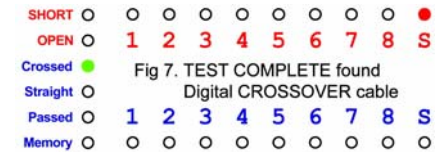

Then either:-  
Press and release the TEST button to clear the display and take you back to step 4. Or see next chapter for how to automatically test cables against details held in memory.



## METHOD 2 - Automatic Double Ended

This method uses the AudioJoG® Pro 8power's internal MEMORY to test against a cables details held in memory. If the cable checked matches, either a digital straight through, or a digital cross over the the corresponding green Straight/Crossed LED will light.

1. Follow the Method 1 instructions until the test completed stage with either both or just the Remote screen LED's on.

2. Press and hold the Test button until the MEMORY (yellow) LED comes on.

Release the Test button will cause the tester to run through all the connections and store them in MEMORY.

After a few seconds the display should show the Pass (green) and MEMORY (Yellow) LED's. If the Fail LED is on then there is probably an intermittant connection in the cable.

3. Plug in the cable to be tested using the same connector(s) and locations as before.

4. Press and release the TEST button. If all is well the Passed LED will turn ON, remove the cable. To test another cable repeat steps 3 & 4.

5. To clear the MEMORY press and hold the test button until the MEMORY LED goes OFF.

6. If the SHORT LED turns ON, then the AudioJoG® Pro 8power has found a difference between the cable details in memory and the current cable. The LED's will stop at the error stage. Examples of failures follow:-

a) A short was found, at the local end within the connector, where no connection existed before (Fig10.).

b) An open connection was found, usually indicated by a single LED (Fig11.).

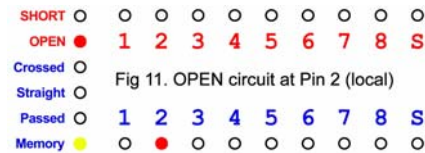
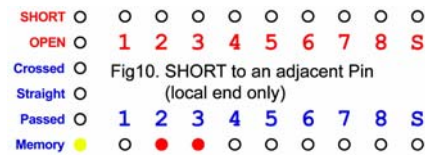
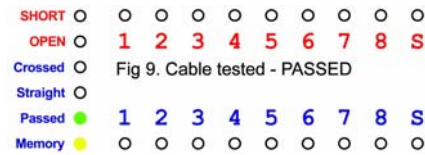
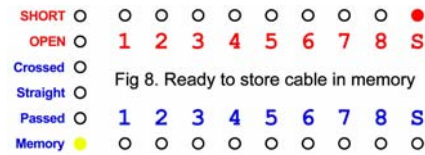

## METHOD 2 - Automatic Double Ended (Continued)

c) A short to SCREEN, this may be indicated by one, or both the screen LED's being ON in conjunction with another pair of LED's (Fig12).

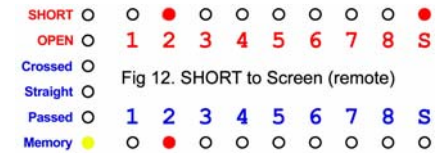

d) A short between two adjacent pins which have connections at both ends of the cable (Fig13).

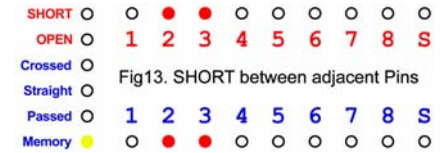

7. Press the TEST button to proceed, if there are more failures the test will stop at each and everyone of them, finally only the FAILED and MEMORY LED's will be ON. To test another cable repeat steps 3 & 4.

8. Press and hold until the MEMORY LED flashes will put the tester into method 3 for detecting intermittent faults, see next chapter, holding the TEST button down until all the LED's go out will reset the tester putting it into mode 1.