



**SUPPLIERS OF MAINTENANCE FREE  
BUILDING PLASTICS,  
SILICONE SEALANTS, ADHESIVES,  
RAINWATER GOODS AND  
BUILDING PRODUCTS**  
**2014**

*Swish*<sup>®</sup>  
BUILDING PRODUCTS

**KESTREL**<sup>®</sup>  
**rely on it**



**[WWW.SEALSERVICE.LTD.UK](http://WWW.SEALSERVICE.LTD.UK)**



BRANCHES AT:

**UNITS 1- 4**  
**KINGFISHER COURT**  
**KESTREL CLOSE**  
**QUARRY HILL IND. EST.**  
**ILKESTON**  
**DE7 4RD**

**TEL: 01159 324308**  
**FAX: 01159 440279**

**UNIT 5**  
**VENTURE COURT**  
**DODWELLS ROAD**  
**HINCKLEY**  
**LEICESTERSHIRE**  
**LE10 3BT**

**TEL: 01455 618800**  
**FAX: 01455 618899**

**UNITS 11 & 12**  
**WAINER CLOSE**  
**OFF SADLER ROAD**  
**DODDINGTON ROAD**  
**LINCOLN**  
**LN6 3RY**

**TEL: 01522 682744**  
**FAX: 01522 682801**

**UNIT 18**  
**DUNSTON TRADING EST.**  
**FOXWOOD ROAD,**  
**SHEEPBRIDGE,**  
**CHESTERFIELD**  
**S41 9RF**

**TEL; 01246 260300**  
**FAX; 01246 450591**

**CONTACT INFORMATION**

**CHRIS SANKEY (MANAGER DIRECTOR)**

ILKESTON  
(BRANCH MANAGER)  
GLENN RYDER

TRADE SALES  
TOM BOURNE  
REECE BROWN

HINCKLEY  
(BRANCH MANAGER)  
PETER COLES

TRADE SALES  
ANDY KNIGHT  
RICHARD HONE

LINCOLN  
(BRANCH MANAGER)  
KEVIN JULIAN

TRADE SALES  
MARK CURTIS

CHESTERFIELD  
(BRANCH MANAGER)  
CHRIS THOMPSON

TRADE SALES  
TONY OXLEY

**SALES**

**GEOFF HURSTHOUSE (SALES DIRECTOR)**

**MOBILE: 07976 775292**

**GARRY WATERS (SALES)**

**MOB; 07794 624184**

**OPENING HOURS**

**MONDAY – THURSDAY 7:30 AM – 4:30 PM**

**FRIDAY 7:30 AM – 4:00 PM**

**(CLOSED SATURDAY)**

**ORDER DEADLINE**

**WE WILL ENDEAVOUR TO MAKE NEXT DAY DELIVERY OF ITEMS IN STOCK IF  
ORDERS PLACED BEFORE 4:00 PM (3.30PM FRIDAY FOR MONDAY)**

**(FREE DELIVERY ON CARRIAGE PAID ORDERS OF £75 NETT)  
ORDERS UNDER £75 SUBJECT TO £5 DELIVERY CHARGE**

**% DISCOUNT AVAILABLE ON RSP PRICES  
(UNLESS STATED AS NET)**



## CONTENTS

### SECTION 'A'

- PAGES 1-3 SILICONE SEALANTS
- PAGE 4 ADHESIVES
- PAGE 5 FOAMS
- PAGE 6 CLEANERS / PAPER ROLLS
- PAGE 7 FIXINGS
- PAGE 8 PACKERS
- PAGE 9 GLAZING ACCESSORIES / MISC

### SECTION 'B'

- PAGES 10-18 U.P.V.C RANGE (WHITE)
- PAGE 19 ROOFING ACCESSORIES
- PAGE 20 POLYCARB SHEETS, LEAD
- PAGES 21-22 SEALBOARD (LAMINATED W/BOARD)
- PAGES 23-28 U.P.V.C FOILED RANGE

### SECTION 'C'

- PAGE 29 RAINWATER GOODS

### SECTION 'D'

- PAGES 30-35 GENERAL BUILDING PRODUCTS

### SECTION 'E'

- PAGE 36-37 DECORATIVE INTERIOR CLADDING

### SECTION 'F'

- PAGES 38-40 SUNDRIES.. SCREWS,DRILL BITS ETC

## SILICONE / SEALANTS

### Optima Sanitary / Construction Silicone (LMA) LOW MOD ACETIC

CODE	COLOUR	SIZE	BOX QTY	RSP	
SCW	WHITE	C3	25	£2.92	
SCT	TRANSLUCENT				
SCBR	BROWN				
SCBK	BLACK				
SCI	IVORY				
SCA	ALUMINIUM GREY (SOUDAL)				
			15		

### Optima 25L (LMN) LOW MOD NEUTRAL CURE

CODE	COLOUR	SIZE	BOX QTY	RSP	
25LW	WHITE	C3	25	£2.94	
25LT	TRANSLUCENT				
25LB	BROWN				
25LBK	BLACK				
25LG	LIGHT GREY				
25LDG	ANTHRACITE GREY (7016)				
25LOK	OAK				

### Other Low Mod Neutral Silicones (SILIRUB 2)

CODE	COLOUR	SIZE	BOX QTY	RSP	
SILRR	RUSTIC RED	310ML	15	£1.99 NETT	
SILPS	PORTLAND STONE		15		
SILBU	BUFF		15		
SILT	• TRANSLUCENT		15		
	• For D/glazed sealed units				

### Optima G.P. Silicone ( To BS5889B) HIGH MODULUS

CODE	COLOUR	SIZE	BOX QTY	RSP	
HMW	WHITE	C3	25	£2.64	
HMT	TRANSLUCENT				
		SIZE	BOX QTY	RSP NET	
HMBSTEEL	BRUSHED STEEL	C3	25	£1.80	

## SILICONE / SEALANTS (continued)

### Acrylic Decorators Caulk

CODE	COLOUR	SIZE	BOX QTY	RSP	
ACW	WHITE	C3	25	£1.34	
ACB	BROWN			£1.80	
ACM	MAGNOLIA				

### Sanitary Silicone ( Guaranteed 10 years to stop black mould)

CODE	COLOUR	SIZE	BOX QTY	RSP		
FEWHT	FOREVER WHITE	C3	12	£2.99NET		
FECLR	FOREVER CLEAR					
FEIV	FOREVER IVORY					

### Lead Sealant

CODE	COLOUR	SIZE	BOX QTY	RSP	
LED	GREY	C3	25	£2.50 NETT	

### Fireseal

CODE	COLOUR	SIZE	BOX QTY	RSP	
FIREW	WHITE	C3	25	£2.00	

### Heatmate

CODE	COLOUR	SIZE	BOX QTY	RSP	
HMBK	BLACK	C3	12	£4.20 NETT	

### Aquarium Sealant

CODE	COLOUR	SIZE	BOX QTY	RSP	
AQT	TRANSLUCENT	C3	12	£2.95 NETT	

### All Weather Sealant (OLIVE)

CODE	COLOUR	SIZE	BOX QTY	RSP	
WMBK	BLACK	C3	12	£2.40	
WMCL	CLEAR			NETT	

## SILICONE / SEALANTS (continued)

### Pyro Mate ( Fire retardant neutral cure silicone)

CODE	COLOUR	SIZE	BOX QTY	RSP	
PMW	WHITE (T/ORDER)	C3	12	£7.00 nett	

### (Galvamate Ducting Sealant)

CODE	COLOUR	SIZE	BOX QTY	RSP	
DUCT	GREY	C3	12	£1.30 nett	

### Roof & Gutter Sealant

CODE	COLOUR	SIZE	BOX QTY	RSP	
ROOFGUT	BLACK	C3	12	£0.90 nett	

### Acoustic Sealant & Adhesive

CODE	COLOUR	SIZE	BOX QTY	RSP	
ACOU	WHITE	C4	12	£3.20	

### Soudaseal Mirror MS Polymer Sealant & Adhesive

CODE	COLOUR	SIZE	BOX QTY	RSP	
MIRW	WHITE	C3	12	£2.99 nett	

### GRAB N SEAL (MS Polymer (Bonds & seals virtually everything))

CODE	COLOUR	SIZE	BOX QTY	RSP	
GRABN WHITE GRABBK GRABN	WHITE BLACK CRYSTAL CLEAR	C3	12	£3.20 nett	

### SOUDAFLEX PU 40 Polyurethane Sealant

CODE	COLOUR	SIZE	BOX QTY	RSP	
SFW SFBK SFG	WHITE BLACK GREY	C3	12	£4.15	

## ADHESIVES

### Gun A Nail (Solvent Free ) Panel Adhesive

CODE	COLOUR	SIZE	BOX QTY	RSP	
GUN1	NATURAL	C3	25	£1.50	

### GRIPFILL (SOLVENTED)

CODE	COLOUR	SIZE	BOX QTY	RSP	
GRIP1		350ml	12	£3.60	

### LUMBERJACK Hardwood Flooring Adhesive (T/Order)

CODE	COLOUR	SIZE	BOX QTY	RSP	
LJ550	NATURAL	290ML	12	£3.20 nett	
LJ650		14KG	1	£64.00 nett	

### Silicone Eater (Silicone Sealant remover)

CODE	COLOUR	SIZE	BOX QTY	RSP	
SET	---	150ml	12	£3.70 nett	

### Superglue

CODE	COLOUR	SIZE	BOX QTY	RSP	
SGT	CLEAR	20g	25	£1.90	

### Superglue Activator

CODE	COLOUR	SIZE	BOX QTY	RSP	
ACT	WHITE	200ml	12	£4.50	

## FOAMS

### Foam & Seal ( Hand Held )

CODE		SIZE	BOX QTY	RSP	
HHF	HAND HELD FOAM	750ml	12	£6.00	

### Foam & Seal ( Gun Grade)

CODE		SIZE	BOX QTY	RSP	
GGF	GUN GRADE FOAM	750ml	12	£6.00	

### Fire Retardant Foam

CODE	DESCRIPTION	SIZE	BOX QTY	RSP	
FR1	B1 (HAND HELD)	750ml	12	£12.00	
FRG1	B1 (GUN GRADE)	750ml	12	£12.00	

### Foam Cleaner

CODE	COLOUR	SIZE	BOX QTY	RSP	
FOC	Foam Cleaner	500ml	12	£6.00	

### Foam Eater

CODE		SIZE	BOX QTY	RSP	
FOE	( TO ORDER ONLY )	250ml	3	£8.00 nett	

### Metal Foam Gun

CODE		SIZE	BOX QTY	RSP	
MFG	Metal Foam Gun	P65	1	£17.50 nett	
FOAM GUN	Economy Metal Foam Gun	P45	1	£12.30 nett	



## CLEANERS

### Glass Cleaner

CODE	COLOUR	SIZE	BOX QTY	RSP	
GC1	BLUE	1LTR	12	£3.40	
GC3		25LTR	1	£44.50	

### UPVC Solvent Cleaner

CODE	COLOUR	SIZE	BOX QTY	RSP	
SCL1	CLEAR	1LTR	12	£4.90	

### UPVC Cream Cleaner

CODE	COLOUR	SIZE	BOX QTY	RSP	
CREAM1	WHITE	1LTR	12	£2.10 nett	

### 2 Ply Paper Rolls

CODE	COLOUR	SIZE	BOX QTY	RSP	
PRS	WHITE (MINI)	20cm x150mt.	6	£5.35	
PRL	WHITE (LARGE)	28cm x 700sheets(259mt)	2	£13.40	

### Hand Wipes

CODE	DESCRIPTION	SIZE	BOX QTY	RSP	
WIPE100	MULTI PURPOSE HAND WIPES	100 WIPES	6	£3.80 nett	

### FOAM BACKER ROD - TO ORDER ONLY

CODE	SIZE	METRES	BOX QTY	RSP NETT	
BACKR13	13mm	750	1	£55.65	
BACKR15	15mm	550	1	£54.70	
BACKR20	20mm	350	1	£49.70	
BACKR25	25mm	200	1	£49.70	
BACKR30	30mm	160	1	£49.70	

## FIXINGS

### Sleeveless Concrete Fixings

CODE	SIZE	BOX QTY	RSP NETT	
MASFIX80	7.5 X 80	100	£5.20	
MASFIX100	7.5 X 100	100	£6.50	
MASFIX120	7.5 X 120	100	£8.00	
MASFIX150	7.5 X 150	100	£10.40	

### Polypins / Polynails

CODE	COLOUR	SIZE	BOX QTY	RSP	
PP01	WHITE	30mm	250	£12.80	
PP02	WHITE	40mm	250	£12.80	
PP03	BROWN	30mm	250	£12.80	
PP04	BROWN	40mm	250	£12.80	
PP05	BLACK	30mm	250	£12.80	
PP06	BLACK	40mm	250	£12.80	
PP07	WHITE	50mm	100	£14.90	
PP08	WHITE	65mm	100	£14.90	
PP09	BLACK	50mm	100	£14.90	
PP10	BLACK	65mm	100	£14.90	
PP11	BROWN	50mm	100	£14.90	
PP12	BROWN	65mm	100	£14.90	
PP13	S/OAK	65mm	100	£14.90	
PP14	S/OAK	30mm	250	£12.80	
PP15	S/OAK	40mm	250	£12.80	
PP16	S/OAK	50mm	100	£14.90	
CP1	CLADDING PIN	30mm	250	£8.56	

## PACKERS

CODE	COLOUR	SIZE	BOX QTY	RSP	
GP10201	GREEN	20 X 100 X 1	1000	£19.15	
GP10202	BLACK	20 X 100 X 2		£22.30	
GP10203	WHITE	20 X 100 X 3		£23.50	
GP10204	GREY	20 X 100 X 4		£27.80	
GP10205	BLUE	20 X 100 X 5		£30.40	
GP10206	RED	20 X 100 X 6		£34.70	
CC10241	GREEN	24 X 100 X 1		£18.70	
CC10242	BLACK	24 X 100 X 2		£19.20	
CC10243	WHITE	24 X 100 X 3		£21.90	
CC10244	GREY	24 X 100 X 4		£25.10	
CC10245	BLUE	24 X 100 X 5		£28.30	
CC10246	RED	24 X 100 X 6		£30.40	
CC10281	GREEN	28 X 100 X 1		£20.30	
CC10282	BLACK	28 X 100 X 2		£23.00	
CC10283	WHITE	28 X 100 X 3		£24.00	
CC10284	GREY	28 X 100 X 4		£25.10	
CC10285	BLUE	28 X 100 X 5		£28.30	
CC10286	RED	28 X 100 X 6		£29.00	
CC10301	GREEN	30 X 100 X 1		£25.10	
CC10302	BLACK	30 X 100 X 2		£25.60	
CC10303	WHITE	30 X 100 X 3		£28.30	
CC10304	GREY	30 X 100 X 4		£28.30	
CC10305	BLUE	30 X 100 X 5		£29.90	
CC10306	RED	30 X 100 X 6		£35.80	
CC10321	GREEN	32 X 100 X 1		£23.00	
CC10322	BLACK	32 X 100 X 2		£27.80	
CC10323	WHITE	32 X 100 X 3	£28.30		
CC10324	GREY	32 X 100 X 4	£29.40		
CC10325	BLUE	32 X 100 X 5	£31.00		
CC10326	RED	32 X 100 X 6	£34.50		

### Bridge Packers

CODE	COLOUR	SIZE	BOX QTY	RSP	
BP2405	BLACK	100 X 24 X 5	1000	£41.70	
BP2005	BLACK	100 X 20 X 5		£34.50	
BP1505	BLACK	100 X 15 X 5		£31.00	

### Wedge Packers

CODE	COLOUR	SIZE	BOX QTY	RSP NETT	
WP2835		28 X 80 X 3-5	1000	£33.10	
WP2824		28 X 80 X 2-4		£30.30	
WP30304		30 X 80 X 4-6		£44.00	
WP2813		28 X 80 X 1-3		£20.50	

## U Frame Packers

CODE	DESCRIPTION	SIZE	BOX QTY	RSP NETT	
UFP2	U FRAME PACKERS	53 X 62 X 2	1000	£21.00	
UFP3	U FRAME PACKERS	53 X 62 X 3		£26.00	
UFP5	U FRAME PACKERS	53 X 62 X 5		£34.00	

## GLAZING ACCESSORIES

### Double Sided Glazing Tape

CODE	COLOUR	SIZE	BOX QUANTITY	RSP	
DSBK2	BLACK	2 X 12	25 X 40mtr	£8.50	
DSBK3	BLACK	3 X 12	25 X 25mtr	£6.20	
DSBK4	BLACK	4 X 12	25 X 20mtr	£5.80	
DSBK5	BLACK	5 X 12	25 X 15mtr	£5.80	
DSW3	WHITE	3 X 10	30 X 25mtr	£5.80	
DSBR3	BROWN	3 X 10	30 X 25mtr	£5.80	
DSBK6	BLACK	3 X 10	30 X 25mtr	£5.80	

### Single Sided Glazing Tape

CODE	COLOUR	SIZE	BOX QUANTITY	RSP	
SSBK3	BLACK	3 X 12	25 X 25mtr	£5.45	
SSBK4	WHITE				

### Trim Mounting Tape

CODE	COLOUR	SIZE	BOX QUANTITY	RSP	
TMT10	WHITE	1 X 10	30 X 50mtr	£8.70	
TMT19	WHITE	1 X 19	15 X 50mtr	£13.60	

### Masking Tape (Low Tack)

CODE	COLOUR	SIZE	BOX QTY	RSP	
LTMT2	PURPLE	25mm X 25mt	60	£1.90	
LTMT3	PURPLE	50mm X 25mt	30	£3.30	

## MISCELLANEOUS

### Screw Cap Covers ( Sold in 50's)

NET

CODE	COLOUR	SIZE		RSP	
SCCW	WHITE	S.W.C. NO	50	£1.49	
SCCB	BROWN	S.W.C. NO	50	£1.49	

UPVC RANGEWHITE

(PRICES QUOTED ARE FOR 5MT. LENGTHS UNLESS STATED)

**ARCHITRAVES**

CODE	DESCRIPTION	PACK QTY	DIAGRAM	RSP	
ARCF45BW	45mm Flat Back	10		£6.50	
ARCF65BW	65mm Flat Back	10		£9.70	
ARCF95BW	95mm Flat Back (5.5mm) (K)	10		£13.70	





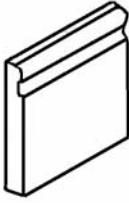

CODE	DESCRIPTION	PACK QTY	DIAGRAM	RSP	
702045BW	45mm Flat Back	10		£11.60	
702065BW	65mm Flat Back	10		£16.20	
702095BW	95mm Flat Back (7.5mm) (K)	10		£24.00	

**SKIRTING**

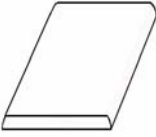
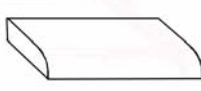
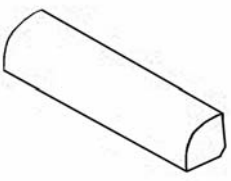

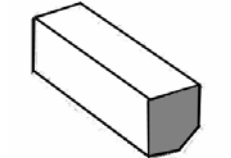
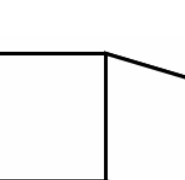
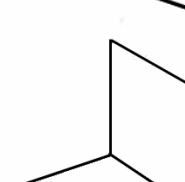
CODE	DESCRIPTION	PACK QTY	DIAGRAM	RSP NETT	
SK70	70mm X 18mm	10		£9.50	
SK95	95mm X 12mm	5		£16.50	
SK125	125mm x 18mm Ogee Skirting	5		£15.50	

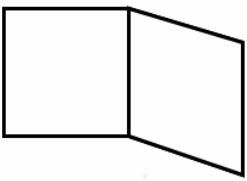
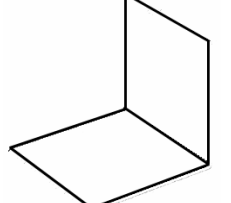
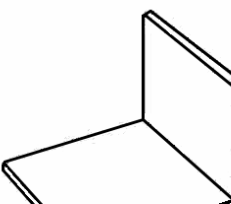
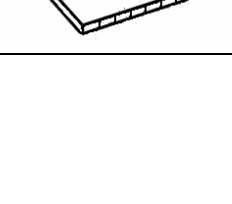
## TRIMS

## WHITE

CODE	DESCRIPTION	PACK QTY	DIAGRAM	RSP	
DM25W	25mm D Mould (S)	24		£4.00	
607/028	28mm D Mould (K)	25		£5.00	
EF20W	20mm Edge Fillet (S)	25		£5.75	
EF25W	25mm Pencil Round (K)	25		£8.00	
QUD12W	12mm Quadrant (S)	20		£5.00	
QUD17W	17.5mm Quadrant (S)	20		£7.00	
FEB28W	28mm Flat Edge Bead (K)	25		£4.50	
CHB20W	20 x 15 Bead (CB) (K)	20		£7.80	
SQ22W	20 x 22 Sq. Bead (G)	18		£12.00	
FLEX25W	25 x 25 Flexi Angle	10		£11.50	
FLEX35W	35 X 35 Flexi Angle	20		£14.30	
FLEX50W	50 x 50 Flexi Angle	15		£19.00	
RIG25W	25 x 25 Rigid Angle	20		£10.00	
RIG40W	40 x 40 Rigid Angle	20		£14.70	
RIG50W	50 x 50 Rigid Angle	10		£19.00	
RIG80W	80 x 80 Rigid Angle	5		£38.00	
RIG100	100X100 Rigid Angle	5		£48.00	
RIG100W	100 x 80 Rigid Angle	5		£36.00	

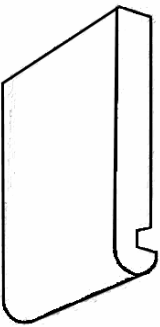
**REPLACEMENT FASCIA****WHITE****25MM BULL NOSE FASCIA ( STANDARD WHITE ONLY)**

CODE	DESCRIPTION	PACK QTY	DIAGRAM	RSP	
BN150	150mm Bull nose Fascia	2		£64.00	
BN175	175mm Bull nose Fascia	2		£73.00	
BN200	200mm Bull nose Fascia	2		£83.00	
BN225	225mm Bull nose Fascia	1		£96.00	
BN250	250mm Bull nose Fascia	1		£103.00	
BN355	355mm Bull nose Fascia (D/E)	1		£165.00	
BN405	405mm Bull nose Fascia (D/E)	1		£170.00	
BNJ	500mm Fascia Joint (D/E)	2			£1.70
BNC	500mm Fascia Corner (D/E)	2	NET		
BNEC	300mm B/nose End Cap(D/E)	5	£2.60		
BNIC	500mm Internal Corner (D/E)	4	NET		

**16MM OGEE REPLACEMENT FASCIA**

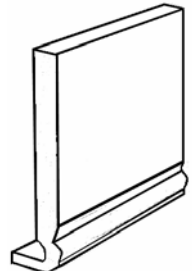
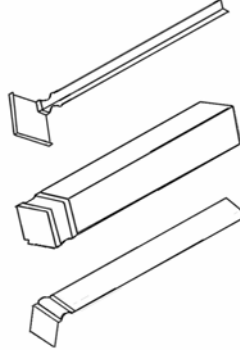
CODE	DESCRIPTION	PAC K QTY	DIAGRAM	RSP	
OGR150W	150mm Ogee Rep. Fascia	2		£60.00	
OGR175W	175mm Ogee Rep. Fascia	2		£68.00	
OGR200W	200mm Ogee Rep. Fascia	2		£72.00	
OGR225W	225mm Ogee Rep. Fascia	2		£78.00	
OGR250W	250mm Ogee Rep. Fascia	2		£88.00	
OGR405W	405mm Ogee Rep. Fascia	2		£146.00	
OGINCW	500mm Internal Corner	2		£5.70	
OGRCOR1	500mm External Corner	2		NETT	
OGRBUT1	500mm Fascia Joint	2		£4.90	
				£4.30	
				NETT	

## REPLACEMENT FASCIA (CONTINUED)

### 16MM SQUARE NOSE FULL REPLACEMENT FASCIA

(Summit)

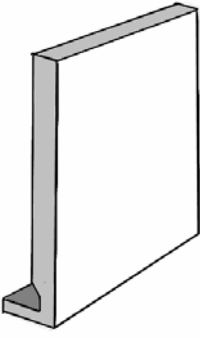
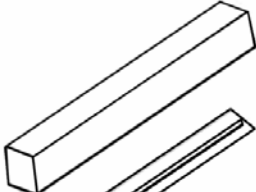
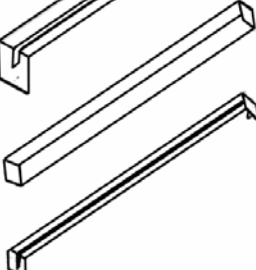
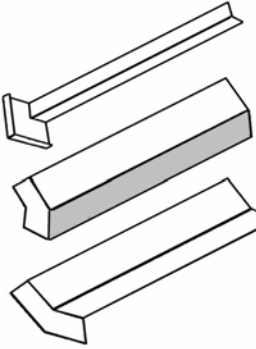
CODE	DESCRIPTION	PACK QTY	DIAGRAM	RSP	
REP150W	150mm Sq. Rep. Fascia	2		£52.50	
REP175W	175mm Sq. Rep. Fascia	2		£58.00	
REP200W	200mm Sq. Rep. Fascia	2		£72.50	
REP225W	225mm Sq. Rep. Fascia	2		£81.30	
REP250W	250mm Sq. Rep. Fascia	2		£90.20	
REP300W	300mm Sq. Rep. Fascia	2		£96.00	
REP355W	355mm Sq. Rep. Fascia	1		£109.00	
REP405W	405mm Sq. Rep. Fascia	1		£152.00	
COR1W	300mm External Corner	50		£0.90 NETT	
BUT1W	300mm Fascia Joint	50		£0.90 NETT	
COR2W	600mm External Corner (Double Ended)	5		£2.60 NETT	
BUT2W	600mm Fascia Joint (Double Ended)	5		£2.60 NETT	
COR3W	300mm Internal Corner	5		£2.20 NETT	
COR135E	135o External Corner	5		£3.70 NETT	
7135/300	135o Internal Corner	5		£4.20 NETT	



### 16MM FLAT FASCIA

CODE	DESCRIPTION	PACK QTY	DIAGRAM	RSP	
FF150W	150mm Flat Fascia	2		£52.40	
FF175W	175mm Flat Fascia	2		£59.00	
FF200W	200mm Flat Fascia	2		£69.90	
FF225W	225mm Flat Fascia	2		£75.00	
FF250W	250mm Flat Fascia	2		£87.00	
FF405W	405mm Flat Fascia	1		£140.00	

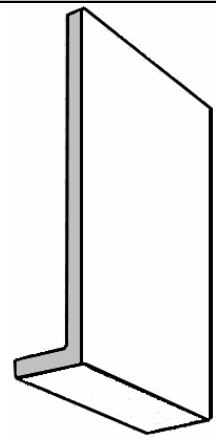

**REVEAL LINER (CAPPING BOARD) (WHITE) (SUMMIT)**

**9MM REVEAL FASCIA**

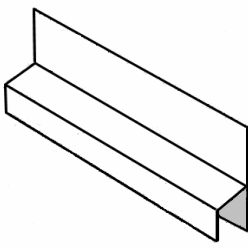
CODE	DESCRIPTION	PACK QTY	DIAGRAM	RSP
REV100W	100mm Reveal Liner	2		£24.15
REV150W	150mm Reveal Liner	2		£29.40
REV175W	175mm Reveal Liner	2		£34.15
REV200W	200mm Reveal Liner	2		£40.05
REV225W	225mm Reveal Liner	2		£45.00
REV250W	250mm Reveal Liner	2		£50.00
REV300W	300mm Reveal Liner	2		£60.00
REV405W	405mm Reveal Liner	2		£77.00
REV600W	605mm Reveal Liner	1		£140.00
REVEC1W	Short End Caps 50mm	50		
REVEC2W	Long E/Caps 250mm	50	80P nett	
COR1W	300mm Ext. Corner	10	<p>SEE PAGE 13</p> 	
COR2W	500mm Ext. Corner	50		
BUT1W	300mm Fascia Joint	10		
BUT2W	500mm Fascia Joint	10		
COR3	300mm Internal Corner	10		
FETW	Felt Edge Trim (K)	10		£10.00

**9MM OGEE REVEAL LINER (To Order only)**

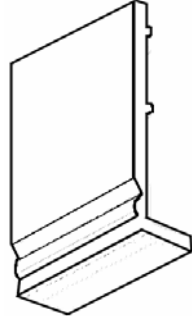
CODE	DESCRIPTION	PACK QTY	DIAGRAM	RSP
OGREV150W	150mm Ogee Reveal	2		£45.00
OGREV175W	175mm Ogee Reveal	2		£52.20
OGREV200W	200mm Ogee Reveal	2		£57.50
OGREV225W	225mm Ogee Reveal	2		£63.00
OGREV250W	250mm Ogee Reveal	2		£68.00
OGREV405W	405mm Ogee Reveal	2		£120.00

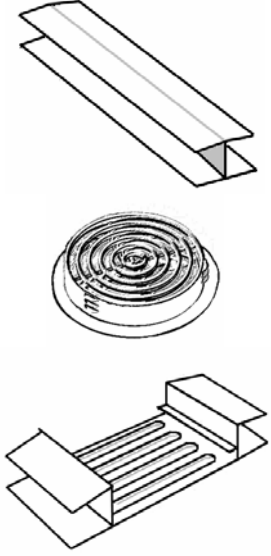

**FLAT BOARD (SOFFIT)****(WHITE)****9MM FLAT BOARD****(SUMMIT)**

CODE	DESCRIPTION	PACK QTY	DIAGRAM	RSP	
FB100W	100mm Flat board	5		£23.20	
FB150W	150mm Flat board	5		£33.30	
FB175W	175mm Flat board	5		£36.90	
FB200W	200mm Flat board	5		£41.00	
FB225W	225mm Flat board	5		£44.00	
FB250W	250mm Flat board	5		£52.00	
FB300W	300mm Flat board	2		£64.00	
FB405W	405mm Flat board	2		£89.00	
FB500W	500mm Flat board	1		£97.00	
FB600W	600mm Flat board	1		£108.00	
691	H Section 5mt (K)	5		£11.25	
691/300	300mm lengths	1	£1.00		
			NETT		
CIRW	Circular Vent	50	£1.14		
SVTW	SOFFIT Vent Trim 8 x 10	5	£14.00		
			NETT		

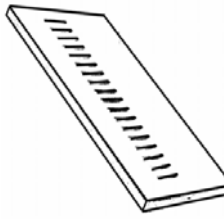
**9MM VENTED FLAT BOARD**



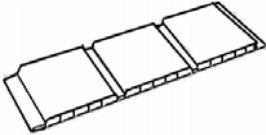
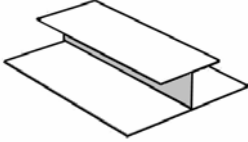

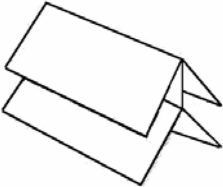
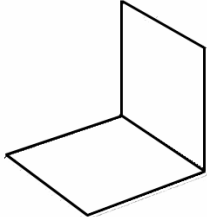



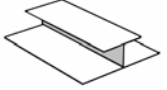
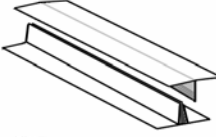

CODE	DESCRIPTION	PACK QTY	DIAGRAM	RSP	
VFB150W	150mm Vented F/board	4		£46.00	
VFB175W	175mm Vented F/board	4		£54.50	
VFB200W	200mm Vented F/board	4		£57.50	
VFB225W	225mm Vented F/board	4		£63.40	
VFB250W	250mm Vented F/board	4		£69.30	
VFB300W	300mm Vented F/board	4		£79.50	
VFB405W	405mm Vented F/board	4		£110.50	

HOLLOWCLAD(WHITE)

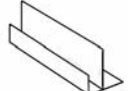
CODE	DESCRIPTION	PACK QTY	DIAGRAM	RSP	
HC300W	300mm Hollowclad (DEEPLAS)	5		£24.00	
HOL300W	300mm Hollowclad (NEWPLAS)	5		£5.98 NETT	
HSJTW	H Section	10		£14.00	
HCUCW	U Channel (Start Trim)	20		£8.30	
EXCW	External Corner	20		£22.00	
RIG25W	25 X 25 Rigid Angle	20		£10.00	
RIG40W	40 X 40 Rigid Angle	20		£14.70	

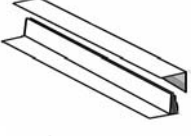
# SHIPLAP CLADDING

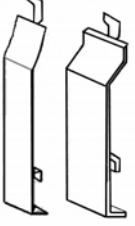
(WHITE)

CODE	DESCRIPTION	PACK QTY	DIAGRAM	RSP
SHIP C150W	150mm Shiplap Cladding (C002)	5		£32.00
SHIP VJC100W	100mm V Joint Cladding (C269)	5		£30.40
SHIPCJTW	Centre Joint Trim (C033)	5		£39.90
SHIPJT2PM	2Part Joint Trim(M)FJTM	5		£18.00
SHIPJT2PF	2Part Joint Trim(F) FJTF	5		£23.40
SHIP WSTW	Shiplap Start Trim (C028)	10		£24.00
SHIPSTW	Shiplap Starter Trim & Batten Cover (C027)	10		£24.90
SHIP UCBCW	Universal Channel & Batten Cover(C040)	10		£25.60
SHIPUCTW	Universal Channel (C026)	5		£20.00
SHIPDTW	Drip Trim (C035)	5		£18.40
SHIP2PUT MW	2/Part Universal Trim(M)	10		£20.00
SHIP2PUT FW	2/Part Universal Trim(F)	10		£20.00
SHIP2PCT MW	2 Part Corner Trim (M)	5		£24.80
SHIP2PCT FW	2 Part Corner Trim(F)	5		£32.00
SHIPBJ 150W	150mm S/lap Butt Joint (C043)	10		£1.50 each
SHIPVBT 100W	100mm V Butt Joint (C281)	10		£1.50 each
SHIPECTW	Ext. Corner (C030)	5		£36.00

WINDOWBOARD(WHITE)9MM BULL NOSE(SUMMIT)

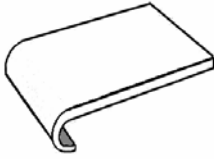
CODE	DESCRIPTION	PACK QTY	DIAGRAM	RSP NETT	
HNB150W	150mm W/ board.	2		£16.50	
HNB175W	175mm W/ board.	2		£19.00	
HNB200W	200mm W/ board.	2		£21.30	
HNB225W	225mm W/ board.	2		£23.30	
HNB250W	250mm W/ board.	2		£27.00	
HNB405W	405mm W/ board.	1		£42.40	
HNBE CW	Short End Caps	5		£0.85net	
HNBLE CW	Long End Caps	10		£1.00net	
WBCW	W/board Channel	20		£5.00	

3MM COVERCILL

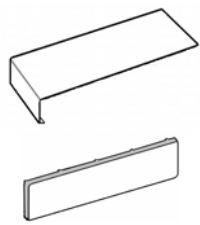
CODE	DESCRIPTION	PACK QTY	DIAGRAM	RSP	
CC240BW	240mm Covercill (Kestrel)(CC240)	5		£68.00	
CE240BW	End Caps (Kestrel)(CE240)	50 Pair		£2.80 pair	

## ROOFING ACCESSORIES

### EAVES PROTECTORS

CODE	DESCRIPTION	SIZE	COLOUR	PACK QTY	RSP	
EP2.5	EAVES PROTECTOR	2.5mt.	Black	10	£9.90	

### EAVES COMB

CODE	DESCRIPTION	SIZE	COLOUR	PACK QTY	RSP	
EC1	EAVES COMB	1mt.	Black	10	£2.70	

### UNI-DRY VERGE

CODE	DESCRIPTION	SIZE	COLOUR	PACK QTY	RSP	
VER1LHB	L/ HAND D/VERGE	280 –	BROWN	10	£5.40	
VER1LHG	L/ HAND D/VERGE	345	GREY	10	£5.40	
VER1RHB	RIGHT HAND		BROWN	10	£5.40	
VER1RHG	D/VERGE		GREY	10	£5.40	

### EAVES RIDGE CLOSURE

CODE	DESCRIPTION (SOLD IN PAIRS)	COLOUR	PACK QTY	RSP net	
EAVCB	EAVES RIDGE CLOSURE	BROWN	2	£3.25	
EAVCG	EAVES RIDGE CLOSURE	GREY	2	per 2	

### UNI-RIDGE END CAP

CODE	DESCRIPTION	COLOUR	PACK QTY	RSP	
URE1BR	RIDGE END CAP (ROUND)	BROWN	2	£13.00	
URE1GR	RIDGE END CAP (ROUND)	GREY	2	£13.00	
URE1BA	RIDGE END CAP (ANGLE)	BROWN	2	£13.00	
URE1GA	RIDGE END CAP (ANGLE)	GREY	2	£13.00	

### UBBINK (3 IN 1)

CODE	DESCRIPTION	PACKQTY	RSP	
UBI	UBBINK 900MM	40	£2.70 nett	

### OVER FASCIA VENTS

CODE	DESCRIPTION	SIZE	COLOUR	PACK QTY	RSP	
OFV01	OVER FASCIA VENT	10mm x 1mt.	BLACK	20	£3.34	

### FINIAL

CODE	DESCRIPTION	COLOUR	PACK QTY	RSP	
FINW	FINIAL 310 X 100mm	WHITE	10	£5.40	
FIN	FOILED 310 X 100mm	M, B, CO, RW	10	£13.00	

## POLYCARBONATE SHEETING

10MM	TWINWALL	CLEAR	OPAL	BRONZE
16MM	TRIPLEWALL	CLEAR	OPAL	BRONZE
25MM	SIXWALL	CLEAR	OPAL	BRONZE

ACCESSORIES; GLAZING BARS, END CAPS ETC. TO SUIT

PVC CORRUGATED SHEETS  
ACRYLIC SHEETS  
FOAMBOARD  
PERSPEX  
SOLID PVC

## LEAD FLASHING

CODE 3,4, STOCK ITEMS (CODE 5,6 & 8 TO ORDER)

SUPPLIED IN 3MT. & 6MT. ROLLS ONLY

PRICES ON APPLICATION

PAGE 20

SEALBOARD (22mm Laminated Window board)

Available in White, Mahogany, Golden Oak, Light Oak, Rosewood.

CODE	SIZE	RSP	COST
SB3600	3MT X 600MM		£120.00
SB3900	3MT X 900MM		£220.00
SB4600	4.1MT X 600MM		£160.00
SB4900	4.1MT X 900MM		£294.00
SB5150	5MT X 150MM		£76.00
SB5180	5MT X 180MM		£90.00
SB5200	5MT X 200MM		£95.00
SB5225	5MT X 225MM		£100.00
SB5250	5MT X 250MM		£107.00
SB5300	5MT X 300MM		£145.00
SBEC	300MM END CAPS		£1.44
SBMJ	380MM MITRE JOINTS		£1.90
ABSEMJ	EXT. MITRE JOINTS		£1.90
ABSEC	FOILED END CAPS		£3.40
ABSM	FOILED MITRE JOINTS		£3.58
ABSEM	FOILED EXT. MITRES		£3.62
WBSK120	15MM SKIRTING (2 X 4.2MT X 120MM )		£31.00 NET (pack 2)
ARCDOOR SET	ARCHITRAVE DOOR SET (2 x 4.2 MT)		£29.00 NET (pack 2)

N.B. WHEN ORDERING, PLEASE STATE  
LENGTH, WIDTH AND COLOUR REQUIRED

PAGE 21

UPVC RANGE (FOILED)



PRICES QUOTED ARE FOR 5MT. LENGTHS UNLESS STATED

COLOUR CODE ; M = MAHOGANY, CO = CHERRY OAK,  
BL = BLACK ASH, RW = ROSEWOOD



Mahogany



Cherry Oak

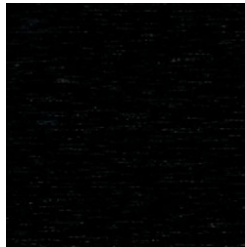

Black Ash



Rosewood



ARCHITRAVES

(KESTREL)

CODE	DESCRIPTION	COLOURS	PACK QTY	DIAGRAM	RSP	COST
ARCF45	45mm Flat Back	M, CO, BL, RW	4		£17.50	
ARCF65	65mm Flat Back		4		£22.00	
ARCF95	95mm Flat Back		4		£27.00	

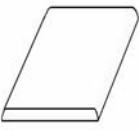
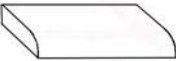
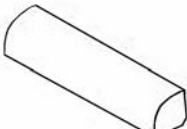

PLEASE CHECK AVAILABILITY ON ALL FOILED PRODUCTS  
WHEN ORDERING

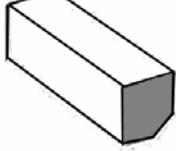
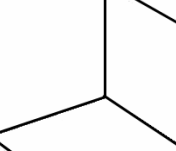
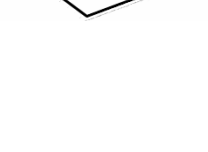
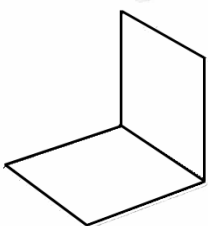
TRIMS(FOILED)

CODE	DESCRIPTION	COLOURS	PAC K QTY	DIAGRAM	RSP	
DM25	25mm D Mould (S)	M, CO, BL, RW	25		£13.10	
EF20	20mm Edge Fillet (S)	M, CO, RW	10		£14.20	
QUD12	12mm Quad (S)	M, RW CO,BL	10		£12.00	
QUD17	17mm Quad (S)	M, CO, BL, RW	10		£13.00	
FEB28	28mm Flat Edge Bead (K)	M, RW CO. BL	10		£14.00	
CHB20	20 x 15 Chamf. Bead (K)	CO RW.	20		£18.00	
SQ22	20 x 22 Square Bead (G)	M, CO BL, RW	18		£34.00	
RIG25	Rig/Angle 25x25	M, CO,	10		£34.00	
RIG30	Rig/Angle 30x30	RW,BL	10		£48.00	
RIG100	Rigid Angle 100 x 80	M, CO, RW	5		£73.00	

PLEASE CHECK AVAILABILITY ON ALL FOILED PRODUCTS  
WHEN ORDERING

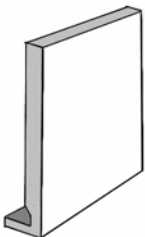
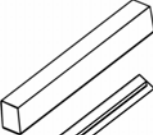
**REPLACEMENT FASCIA 16mm Sq. Nosed (FOILED)**

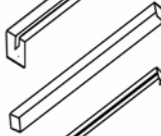
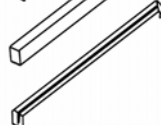

CODE	DESCRIPTION	COLOUR	PACK QTY	DIAGRAM	RSP
REP150	150mm Sq. Rep. Fascia	M, CO BL, RW	2		£80.00
REP175	175mm Sq. Rep. Fascia		2		£88.00
REP200	200mm Sq. Rep. Fascia		2		£106.00
REP225	225mm Sq. Rep. Fascia		2		£112.00
REP250	250mm Sq. Rep. Fascia		2		£123.00
REP400	405mm Sq. Rep. Fascia		1		£200.74
COR1	300mm Ext. Corner		50		£2.50net
BUT1	300mm Fascia Joint		50		£2.50net
COR02	600mm Ext. Corner (K)		10		£5.25net
COR3	300mm Internal Corner (3D)		10		£3.95net
6135	300mm Ext. Corner 135deg (3D)				£3.95net

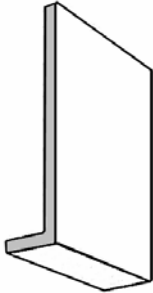
**9MM REVEAL LINER (CAPPING) (FOILED)**

CODE	DESCRIPTION	COLOURS	PACK QTY	DIAGRAM	RSP
REV150	150mm Reveal Liner	M ,CO, BL, RW	2		£54.00
REV175	175mm Reveal Liner		2		£60.00
REV200	200mm Reveal Liner		2		£66.00
REV225	225mm Reveal Liner		2		£72.80
REV250	250mm Reveal Liner		2		£78.00
REV300	300mm Reveal Liner		2		£115.00
REV400	405mm Reveal Liner		2		£136.60
REVEC2	300mm End Caps	FOILED	10		£10.00
COR1	300mm Ext. Corner		50		
BUT1	300mm Fascia Joint		50		
COR05	500mm Ext. Corner		10	AS ABOVE	
BUT05	500mm Fascia Joint		10		
COR3	300mm Int. Corner		10		

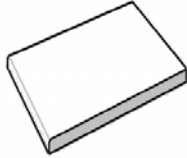
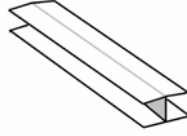

**PLEASE CHECK AVAILABILITY OF FOILED PRODUCTS**

**FLAT BOARD (SOFFIT)****(FOILED)****9MM FLAT BOARD**

CODE	DESCRIPTION	COLOURS	PACK QTY	DIAGRAM	RSP	
FB100	100mm Flat Board	M,CO, BL, RW	2		£33.10	
FB150	150mm Flat Board		2		£44.80	
FB175	175mm Flat Board		2		£54.00	
FB200	200mm Flat Board		2		£56.80	
FB225	225mm Flat Board		2		£64.00	
FB250	250mm Flat Board		2		£84.00	
FB300	300mm Flat Board		2		£90.90	
FB405	405mm Flat Board		2		£118.80	
691	H CHANNEL 5mt	M,CO, BL,RW	5		£20.00	
691/300	300mm lengths		1		£2.00net	
CIR	CIRCULAR VENT	BROWN	50		£1.14	

**PLEASE CHECK AVAILABILITY OF FOILED PRODUCTS**

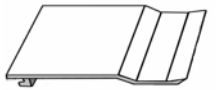
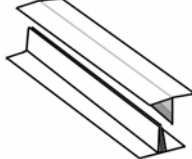
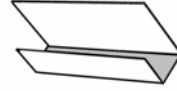
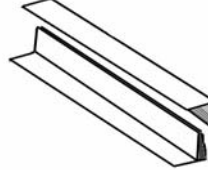
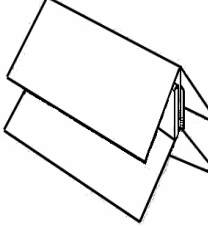
SHIPLAP CLADDING(FOILED)(KESTREL)



CODE	DESCRIPTION	COLOUR	PACK QTY	DIAGRAM	RSP
SHIPC150	150mm Shiplap (670)	M, RW CO,BL	5		£44.00
SHIPVJC100	100mm V Joint Cladding (671)	..	5		£36.00
SHIPJT	Centre Joint Trim (1 part) (676)	..	5		£30.00
SHIPUCT	U Channel (682)	..	2		£31.00
SHIP2PUT	2pt. Universal Trim (681)	..	2		£30.00
SHIP2PCT	2pt Corner Trim (680)	..	2		£90.00
SHIPECT	Ext. Corner Trim (677)	..	2		£34.50
SHIPICT	Int. Corner Trim (675)	..	2		£27.00

PLEASE CHECK AVAILABILITY OF FOILED COLOURS

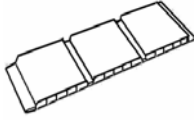
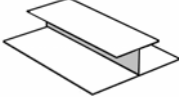
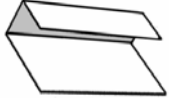
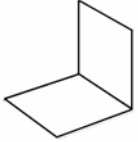
**HOLLOWCLAD****(FOILED)****(KESTREL)**

CODE	DESCRIPTION	COLOURS	PACK QTY	DIAGRAM	RSP	
HC300	300mm Hollow clad	M, CO, BL, RW	5		£70.00	
691	H Section	M, CO, BL, RW	10		£20.00	
HCUC	U Channel	M, CO, BL, RW	10		£16.80	
RIG30	30 X30 Rigid Angle	M,CO,BL,RW	10		£48.00	

**COVERCILL (3mm)****(FOILED)****(KESTREL)**

CODE	DESCRIPTION	COLOURS	PACK QTY	DIAGRAM	RSP	
COV240	240mm Cover sill	M, CO	5		£100.00	
COVEC	End Cap	BROWN & TAN	50		£3.10 pair	

**PLEASE CHECK AVAILABILITY OF FOILED PRODUCTS  
WHEN ORDERING**

## GENERAL BUILDING PRODUCTS (SOME ITEMS TO ORDER ONLY)

(PLEASE CHECK AVAILABILITY)

### MITRE FAST ADHESIVES

CODE	PRODUCT	SIZE	BOX QTY	RSP	
MITRE1	MITRE FAST BONDING KIT	-	6	£7.60	

### CONTACT ADHESIVES

CODE	PRODUCT	SIZE	BOX QTY	RSP	
CON125	CONTACT ADHESIVE	125ML	10	£4.86	
CON250	CONTACT ADHESIVE	250ML	12	£6.70	
CON750	CONTACT ADHESIVE	750ML	12	£9.80	
CONA5	CONTACT ADHESIVE	5LTR	4	£39.20	
CONATHIX5	THIXOTROPIC CONTACT ADHESIVE	5LTR	1	£35.50 net	
CONSPRAY5	CONTACT SPRAY ADHESIVE	500ML	12	£5.48	
PIPE	STICK 2 PIPEWELD PVC CEM	250ML	12	£10.20	
CONTHIN1	CONTACT ADH/THINNER & CLEANER	1LTR	10	£14.80	
CONTHIN2	CONTACT ADH/THINNER & CLEANER	2.5LTR	4	£35.40	

### WOOD FILLERS (METALUX)

CODE	PRODUCT	SIZE	BOX QTY	RSP	
WOODMULTILT2	M/ PURPOSE WOOD FILLER LIGHT	250ML	6	£3.86	
WOODMULTIMED2	M/PURPOSE WOOD FILLER MED/DARK	250ML	6	£3.86	
WOODHPLT1	2 PART WOODFILLER LIGHT	1.4KG	6	£27.98	
WOODHPLT3	2 PART WOODFILLER LIGHT	500GM	6	£9.86	
WOODHPMD1	2 PART WOODFILLER MED/DARK	1.4KG	6	£27.98	
WOODHPMD3	2 PART WOODFILLER MED/DARK	500GM	6	£9.86	
WOODHARD	WET ROT WOOD HARDENER	250ML	6	£5.42	

### FILLERS

CODE	PRODUCT	SIZE	BOX QTY	RSP	
ONE025	ONE STRIKE FILLER	250ML	18	£3.40	
ONE05	ONE STRIKE FILLER	500ML	12	£5.30	
ONE1	ONE STRIKE FILLER	1LTR	6	£8.00	
ONES5	ONE STRIKE FILLER	5LTR	1	£37.20	
FILL15	POWDER FILLER	1.5KG	10	£3.56	
FILL450	POWDER FILLER	450GM	16	£1.80	
FILL9	POWDER FILLER	9KG	1	£8.80	
RMFILL06	READY MIXED FILLER	600GM	12	£2.60	
RMFILL	READY MIXED FILLER	1KG	12	£3.70	
RMFINE	FINE SURFACE FILLER	600GM	12	£2.52	
RMINST	INSTANT FILLER	330GM	12	£2.60	

## GENERAL BUILDING PRODUCTS (CONT.)

### FILLERS

CODE	PRODUCT	SIZE	BOX QTY	RSP	
PU30G	30 MIN. P U WOOD ADHESIVE GEL	310ML	12	£12.02	
PU30L	30 MIN. P U WOOD ADHESIVE LIQUID	750GR	6	£12.00	
PU5G	5 MIN.P U WOOD ADHESIVE GEL	310ML	12	£8.06	
PU5L	5 MIN. P U WOOD ADHESIVE LIQUID	750GR	6	£12.00	
RESIN1	RESINTITE	1.5KG	1	£20.00	
RESIN3	RESINTITE	3KG	1	£32.92	
RESINT25	RESINTITE	25KG	1	£167.14	

### LINE MARKER SPRAY

CODE	PRODUCT	SIZE	BOX QTY	RSP	
LINEBK	LINE MARKER SPRAY – BLACK	700ML	12		
LINEBLUE	LINE MARKER SPRAY – BLUE	700ML	12		
LINEGREEN	LINE MARKER SPRAY – GREEN	700ML	12		
LINERED	LINE MARKER SPRAY – RED	700ML	12	£3.00	
LINEWE	LINE MARKER SPRAY – WHITE	700ML	12	net	
LINEYEL	LINE MARKER SPRAY – YELLOW	700ML	12		
APPL1	LINE MARKER APPLICATOR	-	1	£16.50 net	
TLINEYEL	PERM MARKER SPRAY (YELLOW)	700ML	12	£4.99 net	

### ALL PURPOSE BONDING AGENTS & ADHESIVES

CODE	PRODUCT	SIZE	BOX QTY	RSP	
PVA05L	501 PVA BOND	500ML	20	£2.64	
PVA1L	501 PVA BOND	1LTR	12	£3.56	
PVA2	501 PVA BOND	2.5LTR	6	£6.92	
PVA5	501 CONTRACTORS PVA BOND	5LTR	4	£4.50 net	
PVAL25	501 PVA BOND	25LTR	1	£98.14	
WOOD125	502 WOOD ADHESIVE BOTTLE	125ML	24	£2.72	
WOOD250	502 WOOD ADHESIVE BOTTLE	250ML	12	£1.78	
WOOD500	502 WOOD ADHESIVE	500ML	20	£2.94	
WOOD01	502 WOOD ADHESIVE	1LTR	12	£5.22	
WOOD5	502 WOOD ADHESIVE	5LTR	4	£20.84	
WOODA25	502 WOOD ADHESIVE	25LTR	1	£141.20	
SBR5L	SBR BOND	5LTR	4	£28.52	
SBRB25	SBR BOND	25LTR	1	£112.16	

### CROMAPOL ONE COAT (ROOF REPAIR)

CODE	PRODUCT	SIZE	BOX QTY	RSP NETT	
EVCRY5	ONE COAT BLACK / GREY	5KG	4	£25.00	
EVCRL20GY	ONE COAT GREY	20KG	1	£99.98	



## GENERAL BUILDING PRODUCTS (CONT.)

### SURFACE TREATMENTS

CODE	PRODUCT	SIZE	BOX QTY	RSP
BC1L	401 BRICK & PATIO CLEANER	1LTR	12	£2.64
BC5L	401 BRICK & PATIO CLEANER	5LTR	4	£5.26
WAT5	WATER SEAL	5LTR	4	£26.76
WAT25	WATER SEAL	25LTR	1	£129.00
CHD5L	CONC. HARDENER & D/PROOFER (C)	5LTR	4	£6.36
CHDU25	CONC. HARDENER & D/PROOFER (C)	25LTR	1	£40.00
MMRL1	MOSS & MOULD REMOVER (C)	1LTR	12	£5.14
MMRL5	MOSS & MOULD REMOVER (C)	5LTR	4	£11.50
PAT5	405 DEFENDER PATH & PATIO SEAL	5LTR	4	£21.62
PAT25	405 DEFENDER PATH & PATIO SEAL (C)	25LTR	1	£38.48 N
STAB5	STABILISING SOLUTION	5LTR	4	£19.56
MORSTAIN5	407 MORTAR STAIN REMOVER	5LTR	4	£10.62
MORSTAIN25	407 MORTAR STAIN REMOVER	25LTR	1	£50.76
BLOCK25	409 BLOCKGUARD	25LTR	1	£197.86

### BUILDING CHEMICALS

CODE	PRODUCT	SIZE	BOX QTY	RSP
AD5L	201 MORTAR ADMIX (E/B)	5LTR	4	£4.36
ADM25L	MORTAR ADMIX	25LTR	1	£28.12
ILW5L	INTEG LIQUID W/PROOFER	5LTR	4	£12.34
ILWA25	INTEG LIQUID W/ PROOFER	25LTR	1	£37.88
ACC5L	ACC. & FROSTPROOFER	5LTR	4	£6.86
ACCE25L	ACC. & FROSTPROOFER	25LTR	1	£34.80
EMIX5	204 EVERMIX 3 IN 1	5LTR	4	£5.50
EMIX25	EVERMIX 3 IN 1	25LTR	1	£37.88
ESEO	206 STRIKE RELEASE OIL	5LTR		£17.06
ZERO5	ZEROMIX CFF	5LTR	4	£9.56
ZEOM25	ZEROMIX CFF	25LTR	1	£40.36
PMTBK1	208 POWDER MORTAR TONE BLACK	1KG	6	£6.70
PMTRD1	208 POWDER MORTAR TONE RED	1KG	6	£6.70
PMTBN1	208 POWDER MORTAR TONE BROWN	1KG	6	£6.70
PMTMA1	208 POWDER MORTAR TONE MARIGOLD	1KG	6	£6.70
PMTBUFF1	208 POWDER MORTAR TONE BUFF	1KG	6	£6.70
LMTBK1	209 LIQUID MORTAR TONE BLACK	1LTR	12	£8.58
LMTBK5	209 LIQUID MORTAR TONE BLACK	5LTR	4	£24.16

## GENERAL BUILDING PRODUCTS (CONT.)

### PUTTIES/CEMENTS (TO ORDER)

CODE	PRODUCT	SIZE	BOX QTY	RSP	
MPN05	101 M/PURPOSE PUTTY – NATURAL	0.5KG	12	£1.58	
MPB05	101 M/PURPOSE PUTTY – BROWN	0.5KG	12	£1.58	
MPN1	101 M/PURPOSE PUTTY – NATURAL	1KG	12	£2.36	
MPB1	101 M/PURPOSE PUTTY – BROWN	1KG	12	£2.36	
MPN2	101 M/PURPOSE PUTTY – NATURAL	2KG	6	£4.06	
MPB2	101 M/ PURPOSE PUTTY – BROWN	2KG	6	£4.06	
MPN5	101 M/PURPOSE PUTTY – NATURAL	5KG	1	£7.34	
PLUMB7	113 PLUMBERS PUTTY	750GR	12	£5.20	
BUTGC2	102 BUTYL GL/ COMPOUND BROWN	2KG	6	£4.76	
TROWRD	103 NEW TROWEL MASTIC	3KG	6	£9.78	
FIRE05	XL FIRE CEMENT	0.5KG	24	£2.50	
FIRE1	XL FIRE CEMENT	1KG	12	£4.06	
FIRE2	XL FIRE CEMENT	2KG	12	£5.52	
FIRE5	XL FIRE CEMENT	5KG	1	£10.16	
JET3	JETCEM RAPID SET CEMENT	3KG	4	£4.92	
JET6	JETCEM RAPID SET CEMENT	6KG	2	£8.30	
JETSC2	JETCEM PREMIX SAND & CEMENT	2KG	4	£3.58	
JETSC6	JETCEM PREMIX SAND & CEMENT	6KG	2	£8.58	

### CHEMICAL ANCHORS/ EPOXY REPAIRS

CODE	PRODUCT	SIZE	BOX QTY	RSP	
ANCH300	CHEMICAL ANCHOR (C –MIX PLUS)	300ML	12	£5.00 NET	

## GENERAL BUILDING PRODUCTS (CONT.)

### TILE ADHESIVES & POWDER TILE & FLOOR PRODUCTS

CODE	PRODUCT	SIZE	BOX QTY	RSP NET
NS10	NON SLIP TILE ADHESIVE (BOS)	10LTR	1	£5.85
RES02	WATER RES. TILE ADHESIVE	2.5LTR	4	£3.60
RES05	WATER RES. TILE ADHESIVE	5LTR	1	£6.40
RES10	WATER RES. TILE ADHESIVE	10LTR	1	£10.90
FIX005	FIX & GROUT ADHESIVE	500ML	12	£1.88
FIX01	FIX & GROUT ADHESIVE	1LTR	12	£2.45
FIX02	FIX & GROUT ADHESIVE	2.5LTR	4	£4.65
FIX05	FIX & GROUT ADHESIVE	5LTR	1	£8.25
FIX10	FIX & GROUT ADHESIVE	10LTR	1	£14.85
GROUT1	POWDER WALL TILE GROUT	1KG	10	£1.10
GROUT3	POWDER WALL TILE GROUT	3KG	1	£3.60
GROUT10	POWDER WALL TILE GROUT	10KG	1	£11.00
RAPID10	RAPID SET TILE MORTAR	10KG	1	£8.00
RAPID20	RAPID SET TILE MORTAR	20KG	1	£12.30
WIDE05	WIDE JOINT GROUT	5KG	1	£4.00
WIDE20	WIDE JOINT GROUT	20KG	1	£12.30
SEL20	708 SELF LEVEL FLOOR COMPOUND (H)	20KG	1	£6.35
LAT5	709 FLOOR FLEXIPLUS	5LTR	4	£5.00
710SL	710 SL FLEXIPLUS	20KG	1	£17.00
RSPLUS20	RAPID SET FLEXIPLUS	20KG	1	£17.75
RSPLUS10	711 RAPID SET FLEXIPLUS	10KG	1	£11.85
WSTM	713 WHITE SET TILE MORTAR & GROUT	20KG	1	£13.60
WSFLEX	714 WHITE SET FLEXIPLUS	20KG	1	£21.80
TILOT10	TILE ON TIMBER	10LTR	1	£20.80
LATEX SELF LEVEL	( FLEX CONCRETE) SELF LEVEL (BOSTIK)	25KG	1	£8.57

## GENERAL BUILDING PRODUCTS (CONT.)

### BITUMEN & ROOFING PRODUCTS

CODE	PRODUCT	SIZE	BOX QTY	RSP NET	
BITPAINT1	BLACK BITUMEN PAINT	1LTR	12	£3.00	
BITPAINT2	BLACK BITUMEN PAINT	2.5LTR	4	£6.15	
BITPAINT5	BLACK BITUMEN PAINT	5LTR	4	£10.50	
BITPAINT25	BLACK BITUMEN PAINT	25LT	1	£46.80	
BITPRIME1	BITUMEN & FLASHING PRIMER	1LTR	12	£3.00	
BITPRIME5	BITUMEN & FLASHING PRIMER	5LTR	4	£10.50	
BITTROWEL2	BITUMEN TROWEL MASTIC	2.5LTR	4	£7.80	
BITTROWEL5	BITUMEN TROWEL MASTIC	5LTR	4	£14.75	
BITFELT1	ROOF FELT ADHESIVE	1LTR	6	£3.30	
BITFELT2	ROOF FELT ADHESIVE	2.5LTR	4	£6.70	
BITFELT5	ROOF FELT ADHESIVE	5LTR	4	£10.75	
BITFELT25	ROOF FELT ADHESIVE	25LTR	1	£44.00	
BITWEATH5	ALL WEATHER ROOF COATING	5LTR	4	£10.65	
BITWEATH25	ALL WEATHER ROOF COATING	25LTR	1	£46.00	
BITROOF5	BITUMEN ROOFING EMULSION	5LTR	4	£9.50	
BITSOL5	SOLAR REFLECTIVE PAINT	5LTR	4	£17.30	
BITSOL25	SOLAR REFLECTIVE PAINT	25LTR	1	£77.70	
BITDPM5	D.P.M (CROMAPRUF)	5LTR	4	£9.90	
BITDPM25	D.P.M (CROMAPRUF)	25LTR	1	£40.25	
FLASH075	10 MT FLASHING TRADE ROLL	75MM	4	£3.80	
FLASH100	10 MT FLASHING TRADE ROLL	100MM	3	£5.05	
FLASH150	10 MT FLASHING TRADE ROLL	150MM	4	£7.90	
FLASH225	10 MT FLASHING TRADE ROLL	225MM	2	£11.50	
FLASH300	10 MT FLASHING TRADE ROLL	300MM	1	£14.95	

1

### WOOD TREATMENTS

CODE	PRODUCT	SIZE	BOX QTY	RSP NET	
LJCR01	WOOD PRESERVER CLEAR	1LTR	10	£4.80	
LJCR05	WOOD PRESERVER CLEAR	5LTR	4	£13.10	
LJCR25	WOOD PRESERVER CLEAR	25LTR	1	£52.50	
LJDO05	WOOD PRESERVER DARK OAK	5LTR	4	£13.10	
LJGC05	WOOD PRES. GOLDEN CHESTNUT	5LTR	4	£13.10	
LJFG05	WOOD PRESERVER FIR GREEN	5LTR	4	£13.10	
LJRC05	WOOD PRESERVER RED CEDAR	5LTR	4	£13.10	
LJUN01	WOOD TREATMENT (CLEAR)	1LTR	10	£5.70	
LJUN02	WOOD TREATMENT (CLEAR)	2.5LTR	6	£9.75	
LJUN05	WOOD TREATMENT (CLEAR)	5LTR	4	£14.80	
LJUN25	WOOD TREATMENT (CLEAR)	25LTR	1	£64.65	
FMBO05	FENCE MATE BURNT OAK	5LTR	1	£5.20	
FMCO05	FENCE MATE COUNTRY OAK	5LTR	1	£5.20	
FMHG05	FENCE MATE HOLLY GREEN	5LTR	1	£5.20	
FMRR05	FENCE MATE RUSTIC RED	5LTR	1	£5.20	

# SWISH MARBEX

## Wall and Ceiling Panels





## SDS DRILL BITS

CODE	PRODUCT	RSP NET	
SDS05	5.5 X 160MM	£1.78	
SDS07	7 X 160MM	£1.90	
SDS3	8 X 160MM	£2.20	
SDS4	8 X 210MM	£2.64	
SDS5	8 X 260MM	£3.49	
SDS6	10 X 160MM	£2.36	
SDS7	10 X 210MM	£2.80	

	PREMIER RANGE SDS BITS (FOR USE WITH SLEEVELESS FIXINGS)	RSP NET	
SDS06210	6 X 210MM	£2.05	
SDS06260	6 X 250MM	£2.60	
SDS065210	6.5 X 210MM	£2.20	
SDS065250	6.5 X 250MM	£2.80	

	DESCRIPTION	PACK QTY	RSP NET	
GS1	GLAZING SHOVEL	1	£3.75	
GS2	GASKET SHEARS	1	£10.00	
TOOL1	STRIP OUT TOOL	1	£2.15	
SMOOTH1	SMOOTH OUT TOOL	1	£2.15	

## SEALANT GUNS

CODE	COLOUR	SIZE	BOX QTY	RSP NET	
SGPOWER	BLACK	400ML	6	£4.90	
SG400	BLACK	400ML	12	£2.20	

## SCREWS

CODE	SIZE	BOX QTY	RSP NET
SC001	4 X 25 WOODSCREW	200	£1.10
SC002	4 X 30 WOODSCREW	200	£1.20
SC003	4 X 40 WOODSCREW	200	£1.45
SC004	4 X 50 WOODSCREW	200	£1.85
SC005	4 X 60 WOODSCREW	200	£2.18
SC006	4 X 70 WOODSCREW	100	£2.60
SC007	5 X 50 WOODSCREW	200	£2.90
SC008	5 X 60 WOODSCREW	100	£1.80
SC009	5 X 70 WOODSCREW	100	£2.05
SC010	5 X 80 WOODSCREW	100	£2.40
SC011	5 X 100 WOODSCREW	100	£3.00
SC012	5 X 40 WOODSCREW	200	£2.45
SC013	5 X 30 WOODSCREW	200	£2.00
SC042	4 X 20 WOODSCREW	200	£0.90
BP50	BAYPOLE SCREW 4.8 X 50	200	£6.00
BP60	BAYPOLE SCREW 4.8 X 60	200	£7.00
BP70	BAYPOLE SCREW 4.8 X 70	200	£8.00
BP80	BAYPOLE SCREW 4.8 X 80	200	£8.50

### RAWL PLUGS

CODE	SCREW SIZE	PACK QTY	RSP NET
WPRED	6-8-10	1000	£3.90
WPBROWN	10-12-14	1000	£5.50

### DUST SHEETS

CODE	SIZE	PACK QTY	RSP NET
DUST1	12 X 9	10	£4.26
DUST2	24 X 3 (STAIRS)	15	£5.15
1TARP9	TARPAULIN 12 X 9	25	£3.99
1TARP18	TARPAULIN 12 X 18	8	£8.50

### SILICONE SPRAY

CODE	SIZE	PACK QTY	RSP NET
SILSPRAY	SILICONE SPRAY 400ML	12	£2.15
MULTISPRAY	MAINTENANCE SPRAY 400ML	12	£2.20

### GRAFFITI REMOVER

CODE	SIZE	PACK QTY	RSP NET
GRAF	400ML	12	£3.10

### MIXED PACKERS

CODE	SIZE	PACK QTY	RSP NET
MIX1	28MM	100	£2.60



## GENERAL BUILDING MATERIALS

CODE	SIZE	PACK QTY	
GOR01	YELLOW GORILLA TUBS 14 LTR	1	
GOR02	YELLOW GORILLA TUBS 42 LTR	1	
GOR03	YELLOW GORILLA TUBS 75 LTR	1	
FELT01	HARCON BREATHABLE FELT 1MX50M	1	
ROOF001	ROOFING LATH 25X32	N/A	
ROOF002	ROOFING LATH 25X50	N/A	
CAV247	DOUBLE FLANGE CONTRACT CLOSER 2.44MTR	6	
ROLLDR	ROLL OUT DRY RIDGE SYSTEM	1	
COP001	COPPER CLOUT NAIL 30MM 1 KILO BOX	1	
CLOUT001	GALV CLOUT NAIL 50MM 1 KILO BAG	1	
NAIL002	GALV CLOUT NAIL 65MM 1 KILO BAG	1	
FIRST001	FIRST FIX NAIL'S 51MM	3300	
FIRST002	FIRST FIX NAIL'S 63MM	3300	
FIRST003	FIRST FIX NAIL'S 75MM	2200	
FIRST004	FIRST FIX NAIL'S 90MM	2200	
RALWHP51	FIRST FIX HANDY PACK 51MM	1100	
RALWHP63	FIRST FIX HANDY PACK 63MM	1100	
RALWHP75	FIRST FIX HANDY PACK 75MM	1100	
RALWHP90	FIRST FIX HANDY PACK 90MM	1100	
RED001	25KG RED BUILDING SAND	1	
YELL001	25KG RED BUILDING SAND	1	
WASH001	25KG WASHED SAND	1	
CEMENT001	QUINN CEMENT 25KG	1	