



APPLIED MEASUREMENTS LTD.
Transducer Specialists...

+44 (0) 118 981 7339

info@appmeas.co.uk

www.appmeas.co.uk

CBES Series - Low Profile Button Load Cell

Key Features:

- Capacities 0-50kg up to 0-50,000kg
- Sealed to IP65 (IP67 or IP68 submersible options)
- Output 2mV/V
- Accuracy $<\pm 0.15\%$
- Integral Load Button
- Low Profile
- Robust Construction
- 3 Year Warranty



For the Measurement of Compressive Forces

The CBES series of low profile button load cells are designed for the measurement of compressive forces. Its compact size and low height means it can be used in applications where height is at a premium and is often retrofitted. It is suited for both force measurement and weighing applications such as vessel weight measurement. Special customisation options are available and include IP68 rating for fully submersible applications, please speak to our sales team.

The CBES series of load cells can be supplied with a range of our transducer instrumentation such as digital indicators, signal conditioners, digitisers or telemetry systems and can be supplied calibrated as a complete system, please contact our [technical sales team](#).

Options:

- Standard & Special Mounting Bases
- Full Range of Mounting Options Available
- Special Sizes Available on Request
- Other Ranges Available on Request
- IP67 or IP68 (Submersible) Version
- TEDS (Transducer Electronic Data Sheet)
- TEDS Allows Plug & Play with TEDS Enabled Instrumentation.
- USB Version (via DSC-USB)
- High Temperature Version
- Vacuum Application Version
- Single or Multi-Channel PC-Based Monitoring & Data Logging System
- Wireless Version (via T24 instrumentation)

Applications:

- Force Measurement
- Weighing Applications
- Vessel Weight Measurement
- Brake Pedal Force Measurement



APPLIED MEASUREMENTS LTD.

Transducer Specialists...

+44 (0) 118 981 7339

info@appmeas.co.uk







www.appmeas.co.uk

Specification:

Rated Capacity (RC)	kgf	0-50, 0-100, 0-200, 0-500, 0-1000, 0-2000, 0-5000, 0-10000, 0-20000, 0-30000, 0-50000
Operating Modes	Compression Only	
Sensitivity (RO)	mV/V	2 nominal
Zero Balance/Offset	±%/Rated Output	<1.0
Non-Linearity	±%/Rated Output	<0.15
Hysteresis	%/Rated Output	<0.15
Repeatability	±%/Rated Output	<0.10
Temperature Effect on Zero	±%/Rated Output/ °C	<0.010
Temperature Effect on Sensitivity	±%/Applied Load/ °C	<0.010
Input Resistance	Ohms	750 nominal
Output Resistance	Ohms	700 nominal
Insulation Resistance	Megohms	>5000 @ 50Vdc
Excitation Voltage	Volts AC or DC	10 recommended (2-15 acceptable)
Operating Temperature Range	°C	-20 to +80
Compensated Temperature Range	°C	-10 to +70
Storage Temperature Range	°C	-20 to +80
Safe Overload	% of Rated Capacity	150
Ultimate Overload	% of Rated Capacity	300
Deflection @ Rated Capacity	mm	<0.1 typical
IP Rating (Environmental Protection)		IP65 (IP67 & IP68 optional)
Weight	kg	See dimensions table
Fatigue Life		10 ⁸ cycles typical (10 ⁹ cycles on fatigue-rated version)
Cable Length (as standard)	metres	3
Cable Type		4-core screened, PUR sheath, Ø5 nominal
Construction		Stainless Steel, Nickel-Plated, Brass, NBR, PUR
Resolution		1 part in 250,000 (with appropriate instrumentation)

Wiring Diagram:

Wire	Designation
 Red	+ve excitation
 Blue	-ve excitation
 Green	+ve signal
 Yellow	-ve signal
 Screen	To ground - not connected to load cell body



APPLIED MEASUREMENTS LTD.
 Transducer Specialists...

+44 (0) 118 981 7339

info@appmeas.co.uk

www.appmeas.co.uk

Dimensions (mm):

Capacity (kgf)	ØD	ØE	ØF	H	HT	R	M	Weight (kg)
0- 50, 0-100, 0-200, 0-500, 0-1000, 0-2000	59	10	42	21	25	50	M5 x 0.8 (7 deep)	0.35
0-5000, 0-10000, 0-20000	98	20	72	35	40	150	M6 x 1.0 (8 deep)	2.3
0-30,000	115	32	90	47.5	60	250	M12 x 1.75 (16 deep)	3.7
0-50,000	150	44	125	65	80	400	M16 x 2.0 (20 deep)	7.5

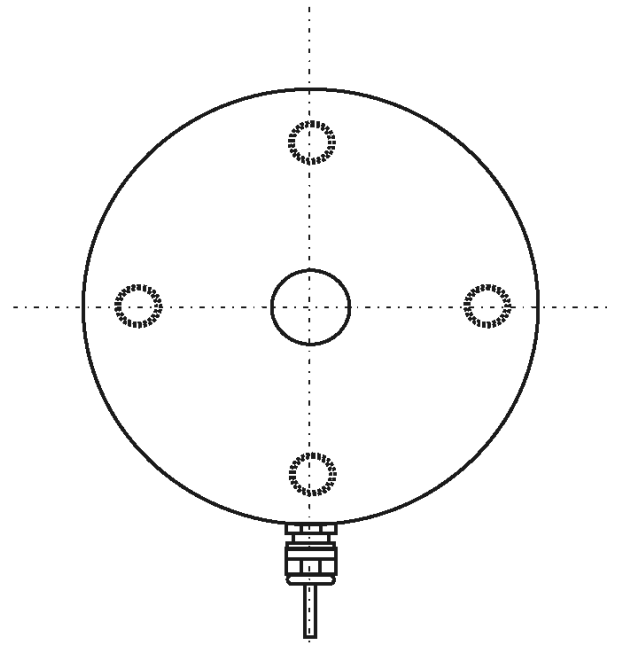
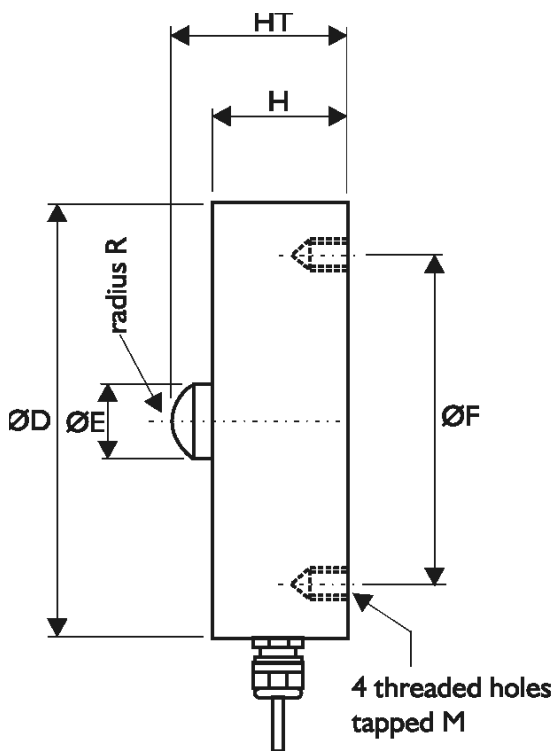



APPLIED MEASUREMENTS LTD.
Transducer Specialists...

+44 (0) 118 981 7339

info@appmeas.co.uk

www.appmeas.co.uk

Ordering Codes:

Core Product	Capacity (inc Engineering Units)	Cable Length (m)	Specials Code	Example Result
CBES	50kg	003	000	CBES-50kg-003-000
CBES	100kg	003	000	CBES-100kg-003-000
CBES	200kg	003	000	CBES-200kg-003-000
CBES	500kg	003	000	CBES-500kg-003-000
CBES	1000kg	003	000	CBES-1000kg-003-000
CBES	2000kg	003	000	CBES-2000kg-003-000
CBES	5000kg	003	000	CBES-5000kg-003-000
CBES	10,000kg	003	000	CBES-10,000kg-003-000
CBES	20,000kg	003	000	CBES-20,000kg-003-000
CBES	30,000kg	003	000	CBES-30,000kg-003-000
CBES	50,000kg	003	000	CBES-50,000kg-003-000

Associated Products:



[TR150 Handheld Indicator](#)



[T24 Wireless Telemetry Range](#)



[Intuitive4-L Panel-Mount Indicator](#)



[DSC-USB USB Signal Digitiser](#)

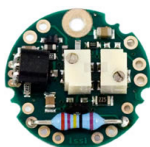

[ICA Miniature Strain Gauge Amplifier](#)



[SGA Signal Conditioner/Amplifier](#)