

PP

Pipe, Fittings,
Hand Operated
Valves &
Accessories



**Product
Catalogue**

+GF+

GEORG FISCHER
PIPING SYSTEMS

List of abbreviations

AL	Number of bolt holes
ABS	Acrylonitrile Butadiene Styrene
ANSI	American National Standard Institute
CR	Chloroprene Rubber, e.g. Neopren
d	Pipe outside diameter
DIN	German standard
DN	Nominal bore
e	Wall thickness
EPDM	Ethylene Propylene Rubber
FM	Fusion Method
FPM	Fluorine Rubber, e.g. Viton [®]
kg	Weight in kilograms
G	Pipe thread, not pressure tight in the thread to ISO 288
HTR	High Temperature Resistant
ISO	International Standardization Organisation
Ms	Brass
NBR	Nitrile Rubber
NPT	Taper male thread pressure tight in the thread to ANSI B 1.20.1
PA	Polyamide
PBTP	Polybutylene terephthalate
PE	Polyethylene
PN	Nominal pressure at 20°C, water
PP	Polypropylene, heat stabilised
PTFE	Polytetrafluorethylene, e.g. Teflon [®]
PVC-C	Polyvinyl Chloride, chlorinated
PVC-U	Unplasticised Polyvinyl, chloride
PVDF	Polyvinylidene fluoride
R	Taper male thread, pressure tight in the thread to ISO 7
Rp	Parallel female thread, pressure tight in the thread to ISO 7
®	Registered trade-mark
s	Across flats
SAN	Styrene-acrylonitrile
SC	Size of hexagon bolts
SP	Standard pack. The figure given indicates the quantity of fittings contained in a standard pack
St	Steel
Tg	Malleable Iron
TM	Trade-mark
Tr	Trapezoid thread
PP-GF	Polypropylene, glassfibre reinforced

CONTENTS

	Page
Materials used for industrial pipe work	2
Design of industrial piping systems	4
Processing and installations	6
Jointing technology	17
PP-H metric	39
PROGEF® Natural	161
PROGEF® Plus	177
Accessories and Machines	201
CODE NUMBER	229

Materials used for industrial pipe work

The material polypropylene (PP)

General

Polypropylene is a thermoplastic belonging to the polyolefin group. It is a semi-crystalline material. Its density is lower than that of other well-known thermoplastics. Its mechanical characteristics, its chemical resistance and especially its relatively high heat deflection temperature have made polypropylene one of the most important materials used in piping installations today.

PP is formed by the polymerisation of propylene (C₃H₆) using Ziegler-Natta catalysts.

There are three different types which are conventionally

supplied for piping installations:

- Isotactic PP Homopolymeride (PP-H)
- PP block co-polymeride (PP-B)
- PP random co-polymeride (PP-R).

Because of its high internal pressure resistance, PP-H is preferred for industrial applications. On the other hand, PP-R is used predominantly in sanitary applications because of its low e-modulus (flexible piping) and its high internal pressure resistance at high temperatures. PP-B is mainly used for sewage piping systems because of its high impact strength especially at low temperatures and its low thermal endurance.

Beta (β)-PP-H

Most of the grades are offered with nucleating agents (crystallisation seeds), because PP crystallises at least 10 times slower than PE. This way, we achieve lower internal stress and a finer structure. We differentiate between α and β nucleation.

Nucleation is realised by merely adding ppm (parts per million) of nucleating agents.

PP is one of the non-polar materials whose surface hardly swells or dissolves. Cementing is not possible without special surface treatment. On the other hand, PP welds very well. Pressure piping systems can use heating element socket welding, heating element butt welding or the no-contact infrared (IR-Plus®) fusion technology developed by GF.

The internal pressure resistance is ensured through long-term testing in accordance with EN ISO 9080 and certified with the value of MRS 10 (minimum required strength).

The Beta (β)-PP used by GF for industrial pipeline engineering is characterised by

- good chemical resistance
- high internal pressure resistance
- high impact strength
- high thermal ageing and thermal forming resistance
- high stress fracture resistance
- outstanding weldability
- homogeneous, fine structure

PROGEF® natural (PP-R)

Specially for applications related to the BCF®Plus (bead and crevice-free) welding technology, such as the life science/pharmaceutical industry, GF offers the PROGEF® Natural system in addition to our Beta-PP-H.

For such requirements, the welding technology plays a decisive role. In using the BCF®Plus welding technology, beads and dead zones are avoided. This prevents micro-organisms from accumulating, thus improving the water quality.

For all other industrial applications, especially those involving aggressive media, high impact and

temperature stress, GF recommends Beta-PP, which has an optimal characteristics profile.

The material used for PROGEF® Natural system is an unpigmented random copolymer, particularly distinguished by the following characteristics:

- excellent resistance against certain disinfectants and chemicals (mainly alkaline solutions)
- translucence
- very high surface finish quality
- good weldability (BCF® Plus and IR Plus® weldable)
- high temperature resistance

Material properties of the different PP types (standard values)

Characteristics	PP-R	β PP-H	Units	Test Standard
Density	0.90-0.91	0.90-0.91	g/cm ³	EN ISO 1183-1
Yield stress at 23 °C	25	31	N/mm ²	EN ISO 527-1
Flexural e-modulus at 23 °C	900	1250	N/mm ²	EN ISO 527-1
Charpy notched impact strength at 23 °C	30.9	85	kJ/ m ²	EN ISO 179-1/1eA
Charpy notched impact strength at 0 °C	3.4	4.8	kJ/ m ²	EN ISO 179-1/1eA
Ball indentation hardness (132N)	49	58	MPa	EN ISO 2039-1
Heat distortion temperature HDT B 0.45 MPa	75	95	°C	EN ISO 75-2
Crystallite melting point	145-150	150-167	°C	DIN 51007
Thermal expansion coefficient	0.16 ... 0.18		mm/m K	DIN 53752
Heat conductivity at 23 °C	0.23		W/m K	DIN 52612-1
Water absorption at 23 °C	0.1	0.1	%	EN ISO 62
Colour	neutral	7032	-	RAL
Limiting oxygen index (LOI)	19		%	ISO 4589-1

Design of industrial piping systems

Application area of pipes and fittings

Pressure/temperature diagram for PP

PP-H

The following pressure/temperature diagram for PP-H pipes and fittings is valid for a lifetime of 25 years.

The design factor of 2.0 recommended by GF is incorporated.

It can be used for water or media resembling water, in other words, media which have no derating factor regarding the chemical resistance.

Remark: Please take into account the pressure/temperature diagrams for our valves. Because of the construction and/or sealing material used, differences are possible when compared with pipes and fittings. This information can be found in the planning fundamentals of the relevant types of valves.

According to the 10 °C line in the hydrostatic strength curve for PP-H, a permissible pressure of 12.2 bar / 7.4 bar in the temperature range of -10° to +10° C for the PN10 / PN6 system can be applied.

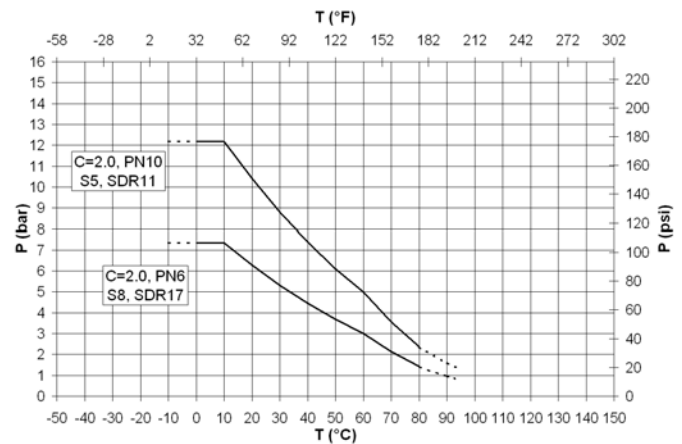

P Permissible pressure in bar, psi

T Temperature in °C, °F

In case of applications with temperatures in the range of the dotted lines please contact your GF representative.

PROGEF® Natural

The following pressure/temperature diagram for PROGEF® Natural pipes and fittings is valid for a lifetime of 25 years.

The design factor of 2.0 recommended by GF is incorporated.

It can be used for water or media resembling water, in other words, media which have no derating factor regarding the chemical resistance.

Remark: Please take into account the pressure/temperature diagrams for our valves. Because of the construction and/or sealing material used, differences are possible when compared with pipes and fittings. This information can be found in the planning fundamentals of the relevant types of valves.

Remark: Using PROGEF® Natural at higher temperatures can lead to a discoloration of the material.

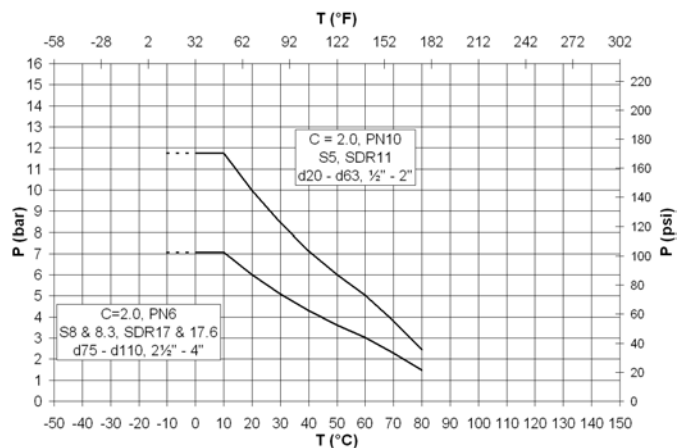

P Permissible pressure in bar, psi

T Temperature in °C, °F

In case of applications with temperatures in the range of the dotted lines please contact your GF representative.

Design of industrial piping systems

Application area of valves

The engineering design of valves supplied by GF is based on the following design standards:

- EN ISO 16135: Industrial valves - Ball valves of thermoplastic materials
- EN ISO 16136: Industrial valves - Butterfly valves of thermoplastic materials
- EN ISO 16137: Industrial valves - Check valves of thermoplastic materials
- EN ISO 16138: Industrial valves - Diaphragm valves of thermoplastic materials
- EN ISO 16139: Industrial valves - Gate valves for thermoplastic materials
- EN ISO 21787: Industrial valves - Globe valves of thermoplastic materials

The valves easily comply with the requirements set out in the above standards. In many cases, they exceed the requirements most notably for pressure / temperature /

load capacity.

It should be noted that depending on the engineering design, at high temperatures there may be a reduction in the application limits of pipes and fittings, whether this be in the amount of the permitted pressure or the maximum temperature.

The technical data concerning

- pressure temperature diagram
- pressure loss
- flow characteristics
- k_v values
- average values for screw fastenings
- mounting and maintenance
- electric or pneumatic actuators

are to be found under the planning fundamentals of the respective valves.

Processing and installations

Change in length and flexible sections

General

Thermoplastics are subject to greater thermal expansion and contraction than metals. Pipes installed above ground, against walls or in ducts, especially those exposed to temperature variations, require changes in length to be taken up in order to prevent extra strain on the pipes. Length changes can be taken up by:

- a) flexible sections
- b) compensators

Flexible sections are the most common solution, being the simplest and the most economical. The calculations for and the positioning of flexible sections are therefore described in detail.

Fundamentals

The low modulus of elasticity of thermoplastics allows changes in length to be taken up by special pipe sections, where pipe supports are positioned so that they can take advantage of the natural flexibility of the material. The length of such sections is determined by the diameter of the pipeline and the extent of the thermal

expansion to be compensated. In order to simplify design and installation, the temperature of the pipe wall, a third factor, will not be taken into account, especially since most pipes are installed in an environment with ambient temperature in the range of 5-25 °C.

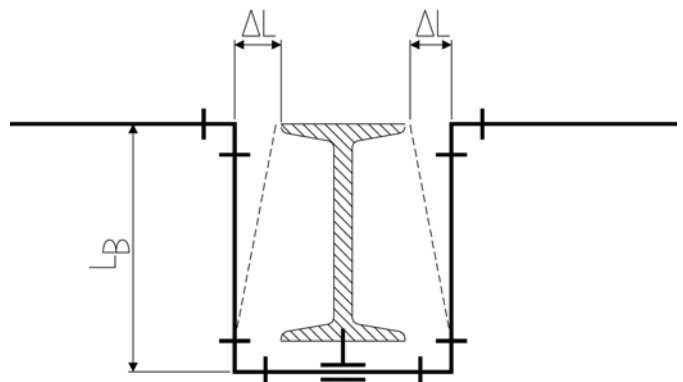
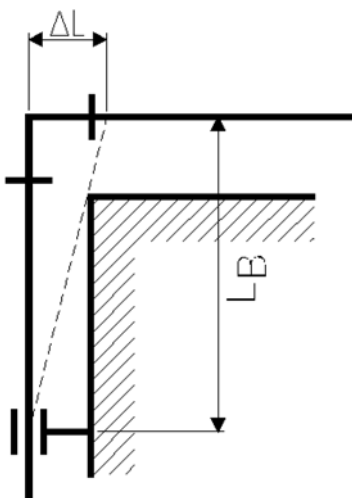
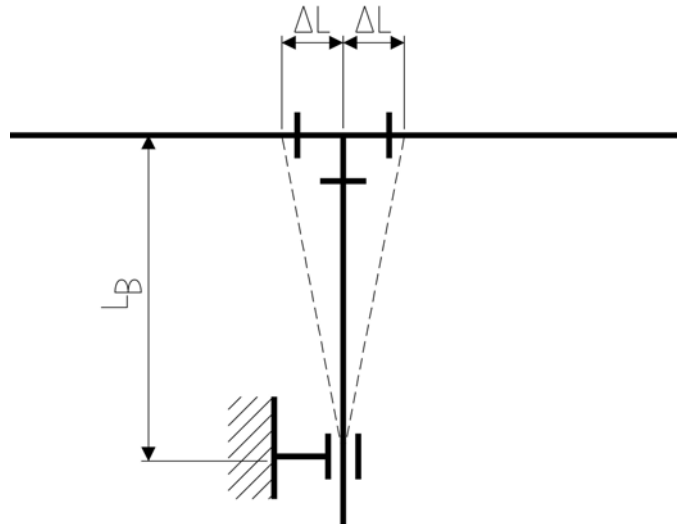
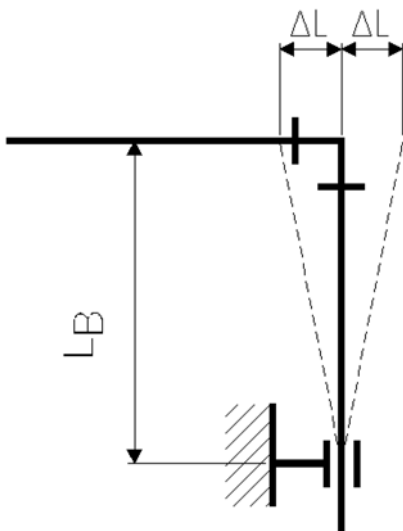

Flexible sections arise naturally at any branching or change in direction of the pipeline. The movement H of the flexible section as a result of a change ΔL in the

length must not be restrained by fixed pipe brackets, protrusions wall, girders or the like.

Calculation of change in length and flexible sections

The **change in length caused by temperature** can be calculated using the following formula:

$$\Delta L = L \cdot \Delta T \cdot \alpha$$

with:

- ΔL = temperature-related change in length (mm)
- L = length of the pipe section (m)
- ΔT = difference of temperature (K)
- α = coefficient of linear expansion (mm / m K)

Some coefficients of linear expansion of polymers:

Material	$\alpha = \text{mm/m} \cdot \text{K}$
ABS	0.10
PA	0.10
PE	0.15 - 0.20
PP	0.16 - 0.18
PPS	0.15
PVC-U	0.07 - 0.08
PVC-C	0.06 - 0.07
PVDF	0.12 - 0.18

Important: If the operating temperature is higher than the installation temperature, then the pipe expands. If,

on the other hand, the operating temperature is lower than the installation temperature, then the pipe contracts in length.

The installation temperature must therefore be incorporated into the calculations as well as the **maximum** and **minimum** operating temperatures.

1. Pipe at installation temperature
2. Operating temperature above installation temperature
3. Operating temperature below installation temperature

Important:

- It is preferable to use + to indicate expansion of the pipe and - to indicate contraction.
- The larger change in length is the one to be used for determining the required length of the flexible section.

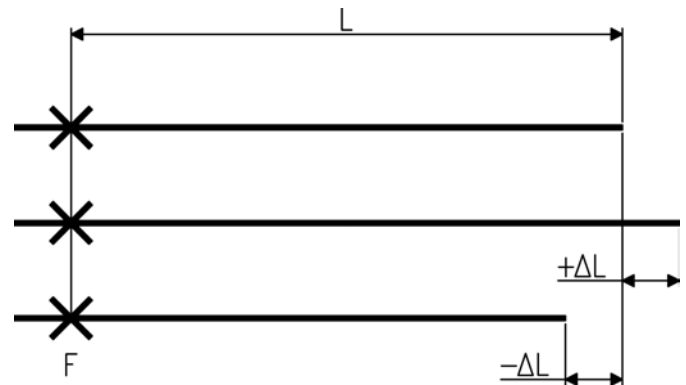

Calculating the length of the flexible section

The required length of the flexible section can be calculated using the following formula:

$$L_B = \sqrt{\frac{3 \cdot d_a \cdot \Delta L \cdot E_{cm}}{\sigma_b}}$$

with:

- d_a = pipe outside diameter (mm)
- ΔL = change in length (mm)
- E_{cm} = average bending creep modulus for $t = 25$ a (N/mm^2)
- σ_b = permitted bending stress for $t = 25$ a (N/mm^2)

Boundary conditions for using the diagram

For easy determination of the required length of flexible section please use the following diagram. Please take into account the given boundary conditions.

- Assembly temperature $T_m = 20$ °C

- T_B Operating temperature
- $\Delta T = T_B - T_m$
- allowable bending stress 15 % of σ_v
- PN 6 .. 16

Diagram for determining flexible sections of PP-H pipelines

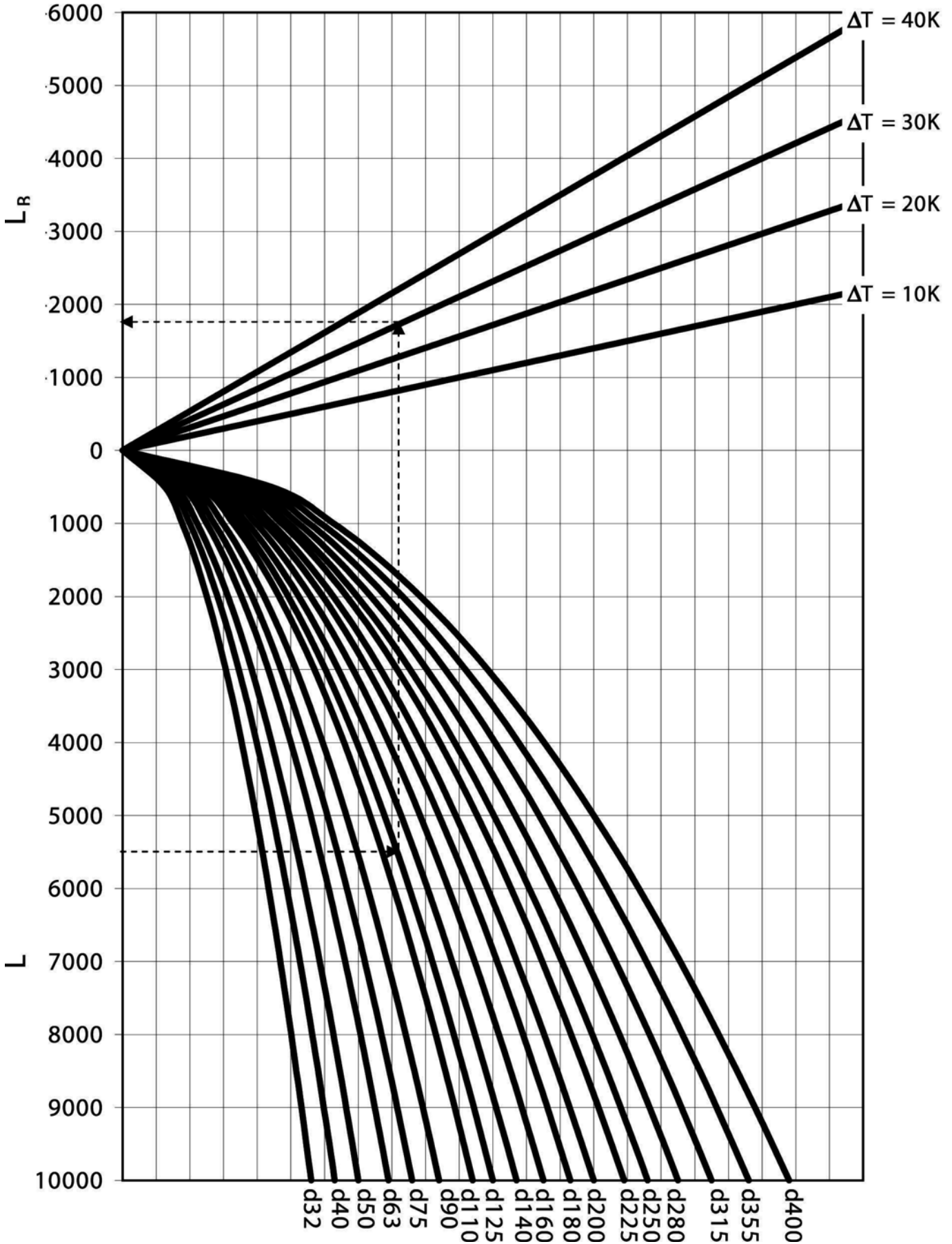

L Length of the pipe section in mm

L_B Required length of flexible section in mm

Diagram for determining flexible sections of PROGEF® Natural (PP-R) pipelines

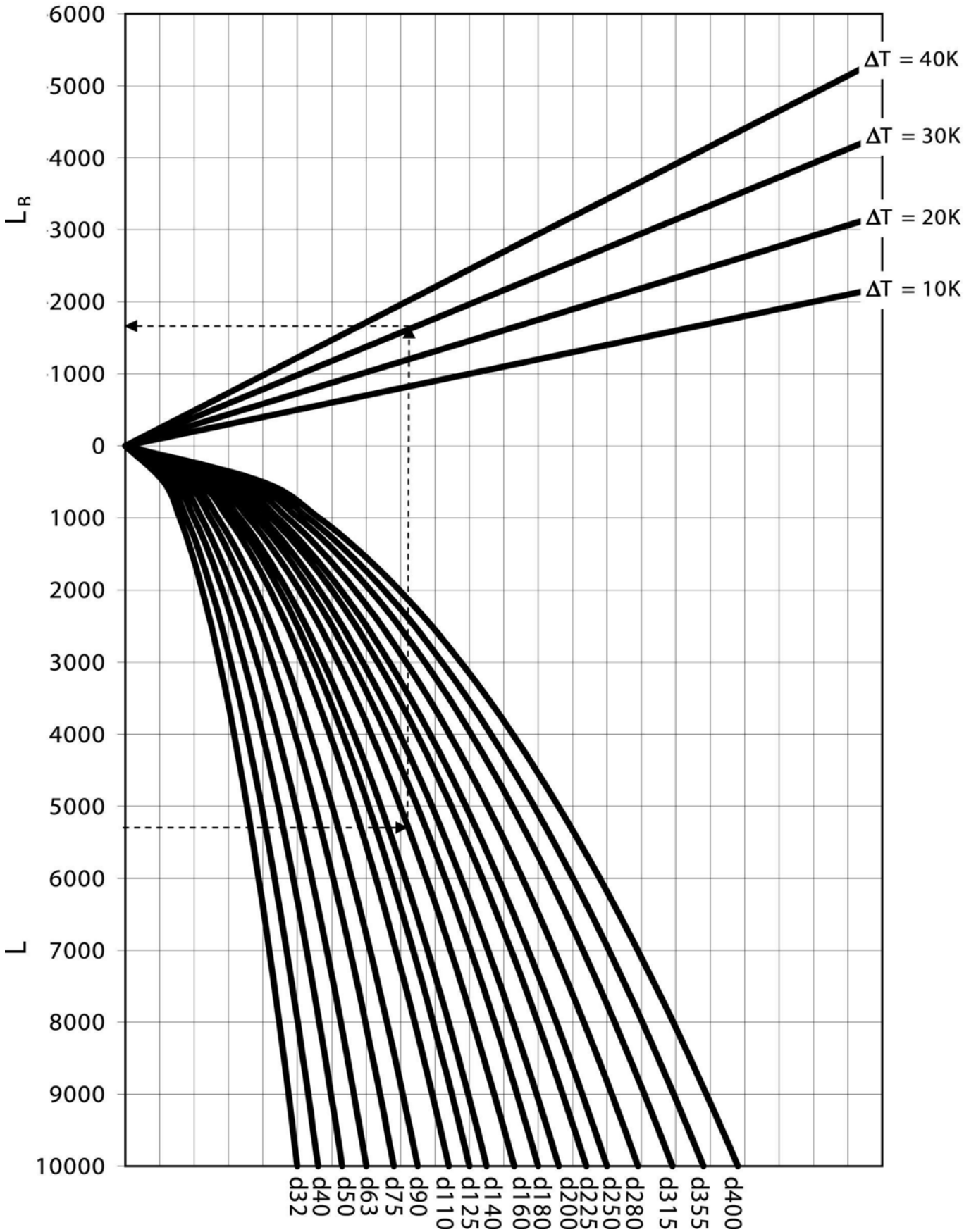

L Length of the pipe section in mm

L_b Required length of flexible section in mm

Example: Determining the required flexible section

Calculating the relevant change in length

The example of an ABS process pipe serves to illustrate the procedure:

Length of piping from the fixed point to the branch point where the change in length is to be taken up: $L = 8 \text{ m}$.

Installation temperature: $T_m = 20 \text{ }^\circ\text{C}$

Max. working temperature: $T_1 = 35 \text{ }^\circ\text{C}$

Min. working temperature: $T_2 = -20 \text{ }^\circ\text{C}$

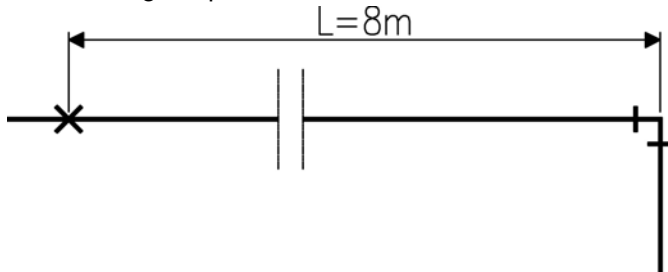

Expansion of the section during heating
 $+\Delta L_1 = L \cdot \Delta T_1 \cdot \alpha = 8 \cdot 15 \cdot 0.10 = 12 \text{ mm}$

Contraction during cooling
 $-\Delta L_2 = L \cdot \Delta T_2 \cdot \alpha = 8 \cdot 40 \cdot 0.10 = 32 \text{ mm}$

Temperature differences

$\Delta T_1 = T_1 - T_m = 15 \text{ }^\circ\text{C}$

$\Delta T_2 = T_2 - T_m = -40 \text{ }^\circ\text{C}$

Maximum change in temperature chosen
 $\Delta T = 40 \text{ }^\circ\text{C}$

Determining the length of the flexible section for ABS

The values needed to determine the necessary length are:

The maximum change in temperature from the 0-position (i. e. from the position in which the pipe was installed). But remember that the pipe could just as well contract as expand.

The pipe diameter d .

The length of the pipe section L .

With these values the required length of the flexible section can be read off from the diagram for ABS.

Continuing with the example introduced before and supposing that an ABS pipe with $d = 50 \text{ mm}$ is installed, the maximum change in temperature being $\Delta T = 40 \text{ }^\circ\text{C}$, the required length of the flexible section is seen directly from the diagram to be $L_b = 1300 \text{ mm}$.

Processing and installations

Pipe bracket spacing and support of pipelines

Pipe bracket requirements

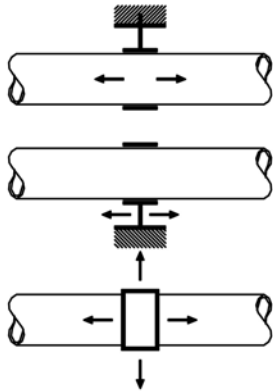

The inner diameter of the pipe bracket must exceed the outside diameter of the pipe in order not to interfere with the free movement of the pipe as a result of expansion or contraction. The inside edges of the pipe brackets must be such that the pipe surface cannot be damaged.

KLIP-IT pipe brackets

GF pipe brackets and clamps satisfy these requirements. These robust plastic pipe brackets can be used not only under rigorous operating conditions, but also where the

pipework is subject to aggressive media or atmospheric conditions. They may be used for all materials of pipes. **Remark:** Don't use KLIP-IT pipe brackets as fixed points!



d 16 to d32



d 40 to d 160

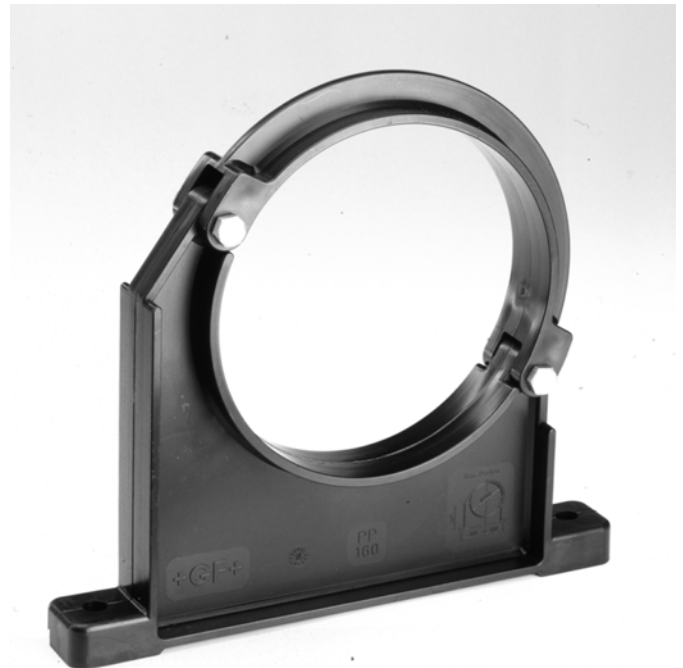

d 90 to d 400

Attention: Starting from the dimension d90 the KLIP-IT brackets must be installed standing, like shown in the assembly examples. The support distances given in the following, specified for the KLIP-IT tubing clamps, apply only to this mounting method.

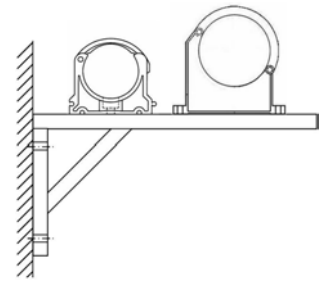
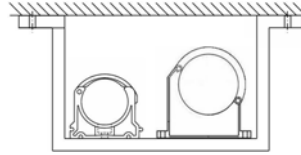
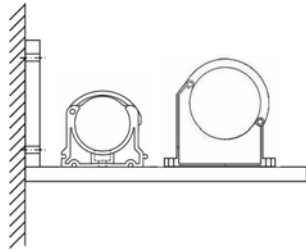

Arranging Loose Brackets

Axial movement of the pipeline must not be prevented by fittings placed next to pipe brackets or by any other component affecting the diameter of the pipe.

Sliding brackets and hanging brackets permit the pipe to move in different directions. Attaching a sliding block to

the base of the pipe bracket permits free movement of the pipe along a flat supporting surface. Sliding and hanging brackets are needed in situations where the pipeline changes direction and free movement of the pipe must be allowed.

Arranging fixed points

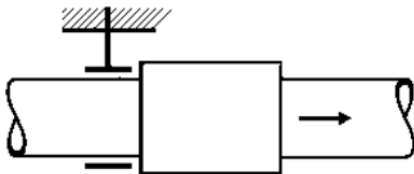

Placing a pipe bracket immediately adjacent to a fitting restricts movement due to changes in length to one direction (one-sided fixed point).

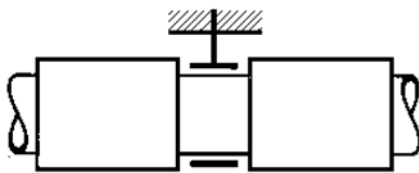

If, as is usually the case, it is necessary to allow changes in both directions, then the pipe bracket must be located between two fittings or a double bracket must be used.

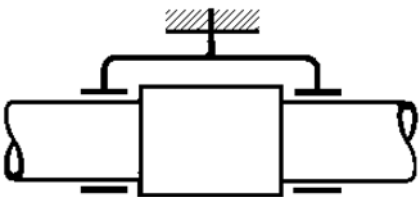

Pipe brackets must be robust and mounted firmly to be able to take up the forces arising from changes in length in the pipeline. Hanging brackets or KLIP-IT pipe brackets are unsuitable for use as fixed points

Pipe brackets for cold insulation (MIP)

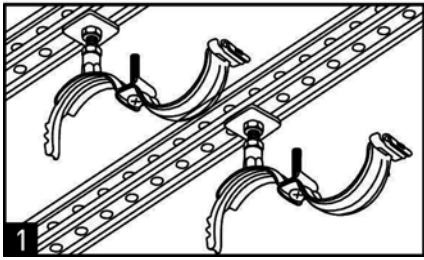

1 Open handle

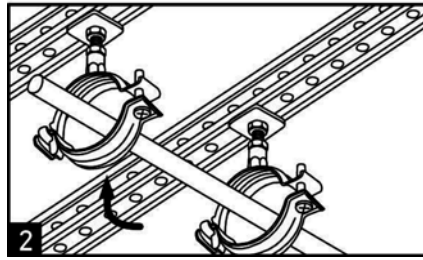

2 Insert pipe
Close handle with quick-action clamp

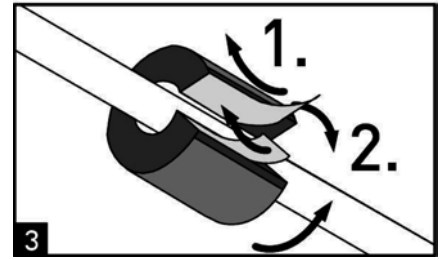

3 Assemble insulation
1. Take off foil
2. Press area of contact

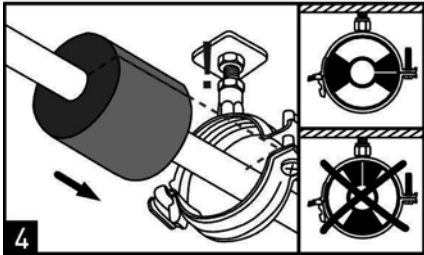

4 Move insulation into the bracket.
Attention! Make sure the insulator is positioned correctly.

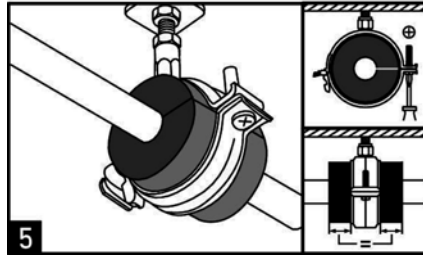

5 Tighten the screw

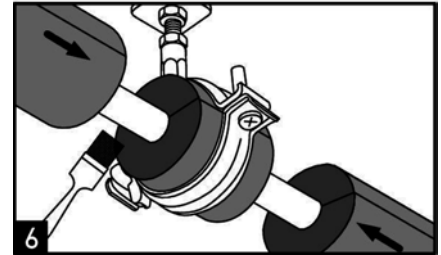

6 Coat areas of contact with adhesive and bond them

Using the tables for pipe bracket spacing

Plastic pipelines need to be supported at certain intervals depending on several factors: the material, the average pipe wall temperature, the density of the medium transported and the size and wall thickness of the pipe. Determining the spacing between pipe brackets is based on the permissible deflection of the pipe between consecutive brackets.

Caution!

The values given in the tables apply only to pipelines which are freely movable in the axial direction.

Pipelines which are fastened tightly in the axial direction (fixed installations) must be checked for buckling. In most cases, this leads to a reduction of the maximum inner pressure and shorter distances between the

support brackets. Furthermore, the forces that act on the fixed points must also be taken into consideration. For assistance, please contact your nearest GF representative.

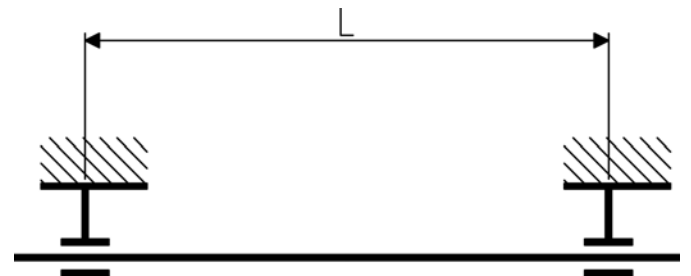

Pipe bracket spacing for PP-H for liquids with a density of 1 g/cm³

d mm	Pipe bracket intervals L for SDR 11 pipes in mm at pipe wall temperature:					
	≤20 °C	30 °C	40 °C	50 °C	60 °C	80 °C
16	650	625	600	575	550	500
20	700	675	650	625	600	550
25	800	775	750	725	700	650
32	950	925	900	875	850	750
40	1100	1075	1050	1000	950	875
50	1250	1225	1200	1150	1100	1000
63	1450	1425	1400	1350	1300	1200
75	1550	1500	1450	1400	1350	1250
90	1650	1600	1550	1500	1450	1350
110	1850	1800	1750	1700	1600	1400
125	2000	1950	1900	1800	1700	1500
140	2100	2050	2000	1900	1800	1600
160	2250	2200	2100	2000	1900	1700
180	2350	2300	2200	2100	2000	1800
200	2500	2400	2300	2200	2100	1900
225	2650	2550	2450	2350	2250	2000
250	2800	2700	2600	2500	2400	2150
315	3150	3050	2950	2850	2700	2450

For other SDR multiply the values given in the table with the following factor:

SDR17 and SDR17.6 with 0.91

The pipe bracket spacing given in the table may be increased by 30 % in the case of vertical pipe runs, i. e. multiply the values given by 1.3.

Pipe bracket spacing for PP-H for fluids of a density other than 1 g/cm³

If the liquid to be transported has a density not equal 1 g/cm³, then the bracket spacing in the table above should be multiplied by the factor given in the following table.

Density of the fluid in g/cm ³	Factor for pipe bracket spacing
1.25	0.96
1.50	0.92
< 0.01	1.30 for SDR11 1.47 for SDR17.6 and SDR17

Pipe bracket spacing for PP-R (PROGEF® Natural) for liquids with a density of 1 g/cm³

d mm	Pipe bracket intervals L for SDR 11 pipes in mm at pipe wall temperature:					
	≤20 °C	30 °C	40 °C	50 °C	60 °C	80 °C
16	500	475	450	425	425	375
20	525	500	500	475	450	425
25	600	575	575	550	525	500
32	725	700	675	650	650	575
40	825	800	800	750	725	650
50	950	925	900	875	825	750
63	1100	1075	1050	1025	975	900
75	1150	1150	1100	1050	1000	950
90	1250	1200	1150	1150	1100	1000
110	1400	1350	1300	1300	1200	1050
125	1500	1450	1450	1350	1300	1150
140	1600	1550	1500	1450	1350	1200
160	1700	1650	1600	1500	1450	1300
180	1750	1750	1650	1600	1500	1350
200	1900	1800	1750	1650	1600	1450
225	2000	1900	1850	1750	1700	1500
250	2100	2050	1950	1900	1800	1600
315	2350	2300	2200	2150	2050	1850

For other SDR multiply the values given in the table with the following factor:

SDR17 and SDR17.6 with 0.91

The pipe bracket spacing given in the table may be increased by 30 % in the case of vertical pipe runs, i. e. multiply the values given by 1.3.

Pipe bracket spacing for PP-R (PROGEF® Natural) for fluids of a density other than 1 g/cm³

If the liquid to be transported has a density not equal 1 g/cm³, then the bracket spacing in the table above should be multiplied by the factor given in the following table.

Density of the fluid in g/cm ³	Factor for pipe bracket spacing
1.25	0.96
1.50	0.92
< 0.01	1.30 for SDR11 1.47 for SDR17.6 and SDR17

Installing closely spaced pipe brackets: Carriers

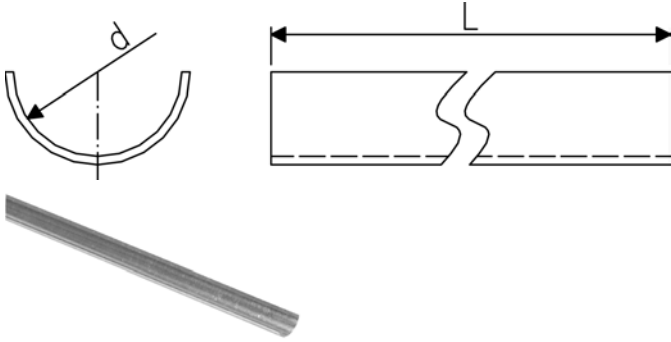

Continuous support may be more economical and practicable than pipe brackets for horizontal or vertical pipework, especially for small diameter pipes and in areas with high temperatures.

In order to avoid inadmissible loadings on the pipelines ensure during assembling an overlapping of the carriers in the pipe brackets.

The following table indicates the spacing distances when using carriers. These values apply regardless of the type of piping material or the temperature.

d mm	Spacing of supports when using carriers mm
16	1600
20	1750
25	1900
32	2000
40	2150
50	2300
63	2500
75	2600
90	2750
110	2900
125	2900
140	2900
160	2900
180	2900
200	2900
225	2900
250	2900
280	2900
315	2900

Flange joints

Creating flange joints

When making a flange connection, the following points have to be taken into consideration:

There is a general difference between the connection of plastic pipes and so called adapter joints, which represent the transition from a plastic pipe to a metal pipe or a metal valve. Seals and flanges should be selected accordingly.

Flanges with sufficient thermal and mechanical stability should be used. GF flange types fulfil these requirements.

Horizontal pipelines should have the shown orientation of the bolts in order to avoid in case of leakage medium drop on the bolts:

Orientation of bolts outside main axis



When inserting a seal between the flange connections, the dimensions of the seal should be checked to make sure they correspond to the outer and inner diameter of

Bolt tightening torque

The torque of the bolts in flange connections is of particular importance. We observe several different methods in practice:

As tight as possible

In time this will definitely overstrain a flange connection in plastic piping systems.

By feel

This requires a good deal of experience and material

the flange adapters. If the deviation between the inner diameter of the seal and the adapter is more than 10 mm, problems may arise with the flange connection.

Before pre-tightening the bolts, the jointing faces must be flush and must sit closely on the seal. Pulling the pipes together within the flange connection is to be strictly avoided because of the tensile stress which results thereof.

The length of the bolts should be selected so that the thread at the nut does not protrude more than 2 to 3 turns. A washer should be placed under the bolt head and also under the nut.

To make sure that the connecting bolts can be easily removed after a lengthy period of use, the thread should be coated with e.g. molybdenum sulphide.

Torque the bolts diagonal and even, that means: first assemble the bolts and hand tight nut, so that the gasket is perfect in place and the flange adapters have an offset as low as possible. Then torque all bolts diagonal up to 50% of the recommended torque, at least to 100 % of the torque.

It is recommended to check and if necessary torque 24 hours after assembling.

After pressure test check and torque if necessary.

For more information to flange connections see DVS 2210-1 Beiblatt 3.

know-how.

Use of a torque wrench

This is the best method. We have listed the recommended values below; however, deviations can occur in practice. These can be caused by the use of, for example, self-locking nuts or pipe axes which are not flush. The Shore hardness of the seal can also influence the necessary torque force (see also the following information concerning sealing materials).

Bolt tightening torque guidelines for metric flange connections with PP-V, PP- steel and PVC-flanges.

Nominal diameter DN	Amount of screws x thread diameter	Bolt tightening torque [Nm]		
		Flat gasket up to max. pressure of 10 bar	Profile gasket up to max. pressure of 16 bar	O-ring up to max. pressure of 16 bar
15	4 x M12	10	10	10
20	4 x M12	10	10	10
25	4 x M12	15	10	10
32	4 x M16	20	15	15
40	4 x M16	25	15	15
50	4 x M16	35	20	20
65	4 x M16	50	25	25
80	8 x M16	30	15	15
100	8 x M16	35	20	20
125	8 x M16	45	25	25
150	8 x M20	60	35	30
200	8 x M20	70 ¹⁾	45	35
250	12 x M20	65 ¹⁾	35	30
300	12 x M20	90 ¹⁾	50	40
350	16 x M20	65 ¹⁾	40	-
400	16 x M24	100 ¹⁾	60	-

1) **Attention:** up to a maximum working pressure of 6 bar

Remark: The indicated torques are recommended by GF, already with these torques a sufficient tightness of the flange connection is ensured. They deviate from the

data in the DVS 2210-1 supplement 3, which are to be understood as upper limit values. Of course our components of the flange connection (adaptors, flanges) are designed to carry these upper limit values.

PP-V flanges

The PP-V flange shows the following properties:

- Corrosion-free backing flange made of polypropylene PP (30% glass fiber reinforced)
- High chemical resistance (hydrolysis resistant)
- Maximum break resistance (deforms if it gets tightened too strong)
- Suitable up to 80°C environmental temperature for use within the temperature range of PVC-U, PVC-C, PP-H, PE100 and ABS.
- For PVDF up to 140°C media temperature the environmental temperature is limited to 40°C
- UV-stabilized



- Integrated fixation aids for the bolts
- Self-centering of the flanges on the flange adaptors
- Symmetric design allows double-sided installation: "wrong side installation" is not possible, all important information are visible



- Application instruction with pictogram:



Socket systems



Butt fusion systems

V-groove (patented)

- To distribute the forces evenly over the flange adapter
- Reduces "creeping" effect on flange adaptors
- No deformation of the flange during the tightening of the bolts up to the recommended torque value

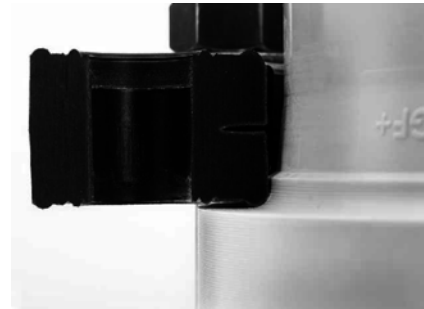

PVC-flanges

PVC-U and PVC-C flanges may also be used as long as the medium or the ambient temperatures does not exceed the following temperature.

Maximum medium- or ambient temperature for PVC-U flanges	Maximum medium- or ambient temperature for PVC-C flanges
45 °C	60 °C

At higher temperatures the flanges could distort with time.

Flanges used at higher temperatures must therefore have adequate thermal and mechanical stability.

GF PP-V-flanges and PP/steel-flanges satisfy this requirements.

Length of bolts

In practice it is often difficult to specify the correct bolt length for flange connections. It can be derived from the following parameter:

- Thickness of the washer
- Thickness of the nut
- Thickness of the seal
- Flange thickness
- Thickness of the flange adapter

The following tables shall give an assistance to determine the necessary bolt length. Due to the various combinations of the individual components only thicknesses of the single parts of flange connections can be given. However simple add them together to determine the necessary bolt length.

Remark: According to DVS 2210-1 determine the necessary bolt length in order to ensure 2-3 screw flights getting over.

1. Thickness of the washer

DN 10 to DN 25	3 mm
DN 32 to DN 400	4 mm

2. Thickness of the nut

DN 10 to DN 25	M 12	SW 18	10.4 mm
DN 25 to DN 125	M 16	SW 24	14.1 mm
DN 150 to DN 350	M 20	SW 30	16.9 mm
DN 400	M 24	SW 36	20.2 mm

3. Thickness of the seal

DN 10 to DN 80	ca. 2 mm
DN 100 to DN 400	ca. 3 mm

4. Flange thickness

	PP-V	PP-Steel	PVC-U PVC-C	Blanking Flange (PVC)
DN 10	--	--	10 mm	--
DN 15	16 mm	12 mm	11 mm	12 mm
DN 20	17 mm	12 mm	12 mm	13 mm
DN 25	18 mm	16 mm	14 mm	15 mm
DN 32	20 mm	16 mm	15 mm	16 mm
DN 40	22 mm	18 mm	16 mm	17 mm
DN 50	24 mm	18 mm	18 mm	20 mm
DN 65	26 mm	18 mm	19 mm	21 mm
DN 80	27 mm	20 mm	20 mm	22 mm
DN 100	28 mm	20 mm	22 mm	24 mm
DN 125	30 mm	24 mm	26 mm	28 mm
DN 150	32 mm	24 mm	28 mm	30 mm
DN 200	34 mm	27 mm	32 mm	36 mm
DN 250	38 mm	30 mm	36 mm	36 mm
DN 300	42 mm	34 mm	36 mm	36 mm
DN 350	--	40 mm	38 mm	38 mm
DN 400	--	40 mm	42 mm	42 mm

5a. Thickness of the metric flange adapter for socket systems, flat or profile gasket

	ABS PVC-C PVC-U	PP PE	PVDF
DN 10	6 mm	--	--
DN 15	6 mm	7 mm	6 mm
DN 20	7 mm	9 mm	7 mm
DN 25	7 mm	10 mm	7 mm
DN 32	8 mm	11 mm	8 mm
DN 40	8 mm	12 mm	8 mm
DN 50	9 mm	14 mm	9 mm
DN 65	10 mm	16 mm	--
DN 80	11 mm	17 mm	--
DN 100	12 mm	18 mm	--
DN 125	14 mm	--	--
DN 150	16 mm	--	--
DN 200	24 mm	--	--
DN 250	23 mm	--	--
DN 300	27 mm	--	--
DN 350	32 mm	--	--
DN 400	34 mm	--	--

5b. Thickness of the metric flange adapter for socket systems, O-ring

	PVC-C PVC-U	PP PE	PVDF
DN 10	9 mm	--	--
DN 15	9 mm	9 mm	9 mm
DN 20	10 mm	10 mm	10 mm
DN 25	10 mm	10 mm	10 mm
DN 32	13 mm	13 mm	13 mm
DN 40	13 mm	13 mm	13 mm
DN 50	14 mm	14 mm	14 mm
DN 65	15 mm	15 mm	--
DN 80	16 mm	16 mm	--
DN 100	18 mm	18 mm	--
DN 125	20 mm	--	--
DN 150	22 mm	--	--
DN 200	31 mm	--	--
DN 250	30 mm	--	--
DN 300	35 mm	--	--
DN 350	--	--	--
DN 400	--	--	--

5c. Thickness of the metric flange adapter for butt fusion systems, flat or profile gasket

	PP PE SDR11	PP PE SDR17	PVDF SDR33 SDR21
DN 10	--	--	--
DN 15	7 mm	--	6 mm
DN 20	9 mm	--	7 mm
DN 25	10 mm	--	7 mm
DN 32	11 mm	--	7 mm
DN 40	12 mm	12 mm	8 mm
DN 50	14 mm	14 mm	9 mm
DN 65	16 mm	16 mm	10 mm
DN 80	17 mm	17 mm	12 mm
DN 100	18 mm	18 mm	13 mm
DN 125	25 mm	18 mm	16 mm
DN 150	25 mm	18 mm	17 mm
DN 200	32 mm	24 mm	22 mm
DN 250	35 mm	25 mm	--
DN 300	35 mm	25 mm	--
DN 350	40 mm	30 mm	--
DN 400	46 mm	33 mm	--

Selection of the seals for flange connections

With consideration to the operating conditions and the sealing forces, the selection of suitable flange seals in thermoplastic piping systems depends on the following factors:

- Form
- Dimension
- Material

Form of the seal

The seal can be a flat gasket, flat gasket with profile or O-ring.

In applications with low working pressures the customary flat gasket, which is made of 2 to 5 mm thick sheet material (depending on the nominal diameter) is used. For flange connections with flat gaskets, flanges which are sturdy enough to withstand the higher torque required for fastening the bolts in such connections are necessary. The flanges from GF meet these requirements.

For increased working and testing pressures, the flat gaskets with profiles and O-rings have proved useful. Compared to the flat gasket, the profiled flat gasket is made of two components. One is the crowned flat gasket

part which is reinforced with steel, and the other is the profiled part (O-ring, lip seal) on the seal inner side.

The stabilized profile flat gasket as well as O-ring gaskets have the following advantages:

- Reliable seal with little screw torque
- Can be used with higher internal pressure and internal vacuum
- Easy to install
- Influenced less by the flange surface
- Safe when connecting pipes of different materials.

Selection of suitable seals, related to the form, can be done with the table below.

Seal form	Recommended limits	Flange version
Flat gasket	p to 10 bar, above DN200 only to 6 bar T to 40°C	With sealing grooves
Flat gasket, profiled	p to 16 bar T= whole application range	With or without sealing grooves
O-ring	p= -1 to 16 bar T= whole application range	With groove

Dimensions of the seal

The dimensions of the seal are determined in the general standards for pipe jointing components. Divergences in the inner or outer diameter of the seal as compared to the flange adapter can in some cases lead

to increased mechanical stress of the flange connection, to accelerated wear of the inner side of the seal as well as deposits inside the pipe.

Seal material

The choice of a seal material is based on the flow media. Details on the suitability of the seal material, or specifically the chemical resistance, can be found in our resistance tables.

The use of seal materials with a high degree of

hardness, e.g. as in steel pipes, is restricted in thermoplastic piping systems because the flange or the adapter could become deformed under the great sealing forces. Elastomere materials, such as EPDM, CSM or FPM with a Shore-A-hardness up to 70° are preferable.

Joining plastic piping components via screw connections

Wherever available, unions are the preferred choice over flange adapters for the connection of plastic pipes. With no metal parts, there is no corrosion and the weight is also reduced. In addition, the smaller outer diameter

means the distance from pipe axis to pipe axis is smaller compared to a flange connection.

Unions are available in several materials:

Solvent cement connections PVC-U PRO-FIT with solvent cement socket/spigot



*

Solvent cement connections ABS, PVC-U, PVC-C with solvent cement sockets



Socket fusion union PP



Butt fusion union PP



Joining technology

Fusion jointing of PP

IR Plus® fusion jointing of β PP-H and PROGEF® Natural piping systems

Fusion jointing method

In infrared (IR) fusion jointing the fusion areas of the components being joined (pipes, fittings, valves) are heated to fusion temperature without contact to the

heating element and jointed by means of mechanical pressure without using additional materials.

The principle of fusion jointing

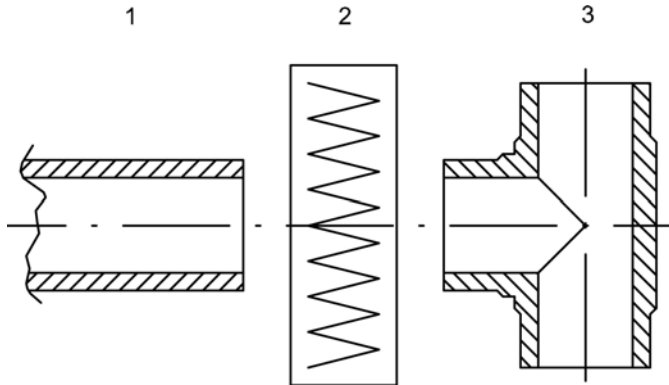

- 1 Pipe
- 2 Heating element
- 3 Fitting

The resulting fusion joints are homogeneous and display the following characteristics:

- non-contact heating of the jointing components eliminates the risk of contamination and inhomogenities;
- smaller jointing beads due to adjustment of jointing pressure path prior to the fusion process itself, i. e. elimination of the equalisation process;
- adjustment of the jointing pressure path also ensures excellent reproducibility of the fusion joints;
- low-stress fusion joints due to very uniform heating by means of IR radiation.

General requirements

The basic rule is that only similar materials can be fusion jointed. For the best results only components which have a melt flow index in the range from MFR 190/5 0.4 to 0.8 g/10 min should be fusion jointed.

The components to be jointed must have the same wall thicknesses in the fusion area. Maximum permissible wall displacement: 10 %.

Only same wall thicknesses in the fusion area

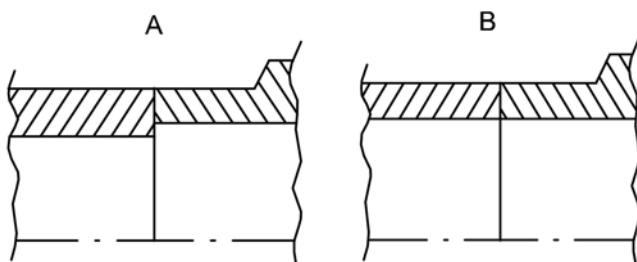

- A incorrect
B correct

IR fusion jointing must only be performed by personnel trained in the use of this method. Training is provided world-wide by qualified GF IR Plus® welding instructors.

Tools required

Infrared fusion jointing requires a special jointing machine in addition to the tools normally used for plastic pipework construction (pipe cutters, etc.).

GF supplies two types of IR Plus® fusion jointing machines:

IR63 Plus®: for fusion joints in the size range d20-63 mm



IR225 Plus®: for fusion joints in the size range d63-225 mm



General conditions

Protect the area of the fusion joint from adverse weather conditions, such as rain, snow or wind. The permitted temperature range for IR Plus® fusion jointing is between +5 °C and +40 °C. Outside this range, suitable

action must be taken to ensure that these conditions are maintained and all components being joined are in this temperature range.

Preparing the fusion joint and operating the IR fusion jointing machine

In principle, IR fusion jointing machines do not require any special preparation, other than to ensure that all components being joined are clean.

Operation of the IR machines is defined in the operating instructions, but we strongly recommend attending a 1-day training course to become a qualified IR welder.

Properties and characteristics of IR fusion joints

Non-contact heating

The components being joined are heated uniformly and without contact to the ideal fusion temperature by infrared radiation.

A defined gap between the heating element and the end faces minimises the risk of contamination of the jointing surface. Contamination of the heating element by plastic particles is thus also eliminated.

Reduced bead formation

The fusion bead produced during jointing is considerably reduced without any loss of quality. Bead-forming equalisation is eliminated by non-contact softening of the end faces. The minimal, defined bead is only formed during the jointing process. The fusion area thus has improved flow dynamics, low clearance volume and greater throughput area.

Reproducible jointing processes

The jointing path controls the jointing pressure and thus the fusion process. The high reproducibility of the joints is assured by the clearly defined and controlled process sequence.

Clear, simple operator guidance

Clear, unambiguous operator guidance via the liquid crystal display leads the user interactively through the fusion process in logical operating steps.

Welding report/traceability

The welding parameters for the relevant welding operations can be read out directly via various interfaces on the machine. It is possible to print these out on paper (commercially available printers), on labels or to employ electronic data output (PCMCIA card).

This automatically provides an accurate record with all the essential fusion parameters for each individual fusion joint.

Joining technology

Fusion joining of PP

BCF® Plus fusion joining of PROGEF® Natural piping systems

Fusion joining method

The fusion joining process consists in transmitting precisely defined thermal energy to the pipe and fitting ends being joined by means of half-shell heating elements.

At the same time an elastic, pressurised bladder supports the inside surface of the fusion zone in order to prevent the formation of an internal fusion bead.

Holding the melted thermoplastic under controlled pressure ensures ideal, homogeneous fusion of the plastic components.

Fully automatic process control of the fusion joining process with a fusion joining machine developed in-house by GF permits very simple handling and reproducible fusion quality.

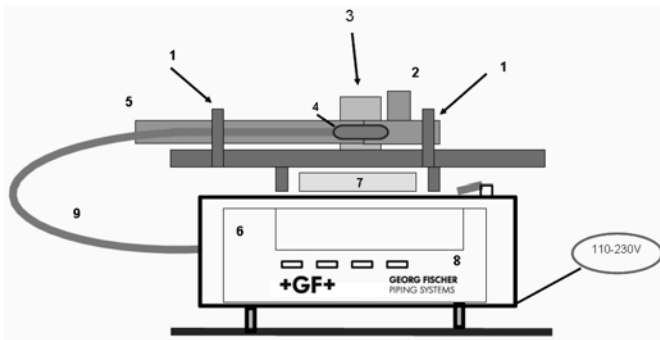

- 1 Pipe clamping element
- 2 Fitting
- 3 Heating element with fitting - clamping device
- 4 Pressurised bladder
- 5 Pipe
- 6 Compressor for bladder
- 7 Cooling air blower
- 8 Control unit control panel
- 9 Compressed air supply

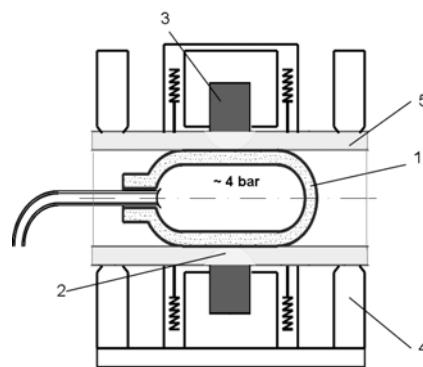

- 1 Pressurised bladder
- 2 Welding zone
- 3 Heating element
- 4 Clamping position
- 5 Pipe / Fitting

General requirements

PROGEF® Natural fittings and pipes are suitable for working pressures up to 10 bar at 20 °C (water).
PROGEF® Natural diaphragm valves are designed for a

maximum working pressure of 10 bar at 20 °C (water).
Refer to the chapter on pressure/temperature diagrams for details of permissible working pressures.

Tools required

BCF jointing requires the GF BCF® Plus jointing machine in addition to the tools normally used for plastic pipework construction (pipe cutters, etc.).



Preparing the fusion joint and operating the BCF® Plus fusion jointing machine

In principle, GF BCF® Plus fusion jointing machines do not require any special preparation, other than to ensure that all components being jointed are clean.

Operation of the BCF® Plus machines is defined exactly in the operating instructions, but it is strongly recommended to attend a 1-day training course to become a qualified BCF® Plus welder.

Properties and characteristics of BCF® Plus fusion joints

Welding free from beads and crevices

The result of the jointing process is a surface similar to the actual pipeline components, free from beads or crevices. There are therefore no dead legs, the surface roughness is in the range of the pipe components.

Reproducible jointing processes

The high reproducibility of the joints is assured by the clearly defined and controlled process sequence.

Clear, simple operator guidance

Clear, unambiguous operator guidance via the liquid

crystal display leads the user interactively through the fusion process in logical operating steps.

Welding report / traceability

The welding parameters for the relevant welding operations can be read out directly via various interfaces on the machine. It is possible to print these out on paper (commercially available printers), on labels or to employ electronic data output (PCMCIA card).

This automatically provides an accurate record with all the essential fusion parameters for each individual fusion joint.

Joining technology

Fusion joining of PP

Butt fusion joining of PP piping systems

Butt fusion joining method

The fusion areas of the pipes and fittings are heated to fusion temperature and joined by means of mechanical pressure, without using additional materials. A homogeneous joint results. Butt fusion must only be carried out with fusion joining machines which allow the joining pressure to be regulated. Details of the requirements for machines and equipment used for fusion joining thermoplastics are contained in DVS 2208 Part 1. The drawing to the right illustrates the principle of fusion joining.

The principle of fusion joining

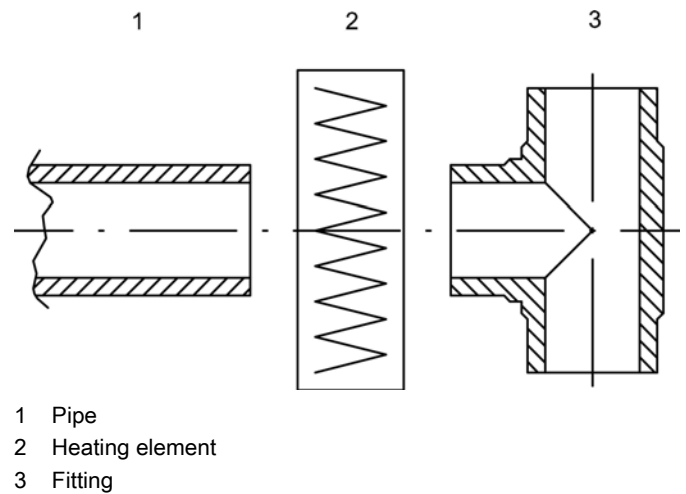

General requirements

The basic rule is that only similar materials can be fusion joined. For best results, only components which have a melt flow index in the range from MFR 190/5 0.4 to 1.0 g/10 min should be fusion joined. This requirement is met by PP butt fusion fittings from GF.

The components to be joined must have the same wall thicknesses in the fusion area. Heated tool butt fusion joining may only be performed by adequately trained personnel.

Join only components with similar wall thicknesses

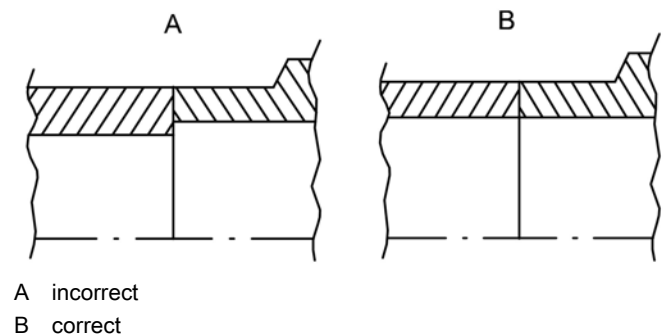

Tools required

Butt fusion joining requires a special joining machine in addition to the tools normally used for plastic piping construction (pipe cutters, saw with cutting guide). The fusion joining machine must meet the following minimum requirements:

The clamping equipment must hold the various parts securely without damaging the surfaces. Possible ovality can be largely compensated by centred clamping of the components to be joined. It must also be possible to hold all parts firmly in alignment.

The machine must also be capable of face planing the fusion surfaces of pipes and fittings.

The fusion joining machine must be sufficiently solid to be able to absorb the pressures arising during the fusion procedure without detrimentally deforming the joint.

The heating surfaces of the heating element must be flat and parallel. The temperature variation over the working area must not exceed 10 °C. The machine should be set up and operated according to the manufacturer's instructions.

The fusion procedure detailed below including the preparation is based on DVS 2207-11 Welding of thermoplastics - Heated tool welding of pipes, pipeline, components and sheets out of PP.

General conditions

Protect the area of the fusion joint from adverse weather conditions, such as rain, snow and wind. At temperatures below +5 °C or above +45 °C, measures

must be taken to ensure that the temperature in the working area is in the range required for satisfactory jointing and does not hinder the necessary manual tasks.

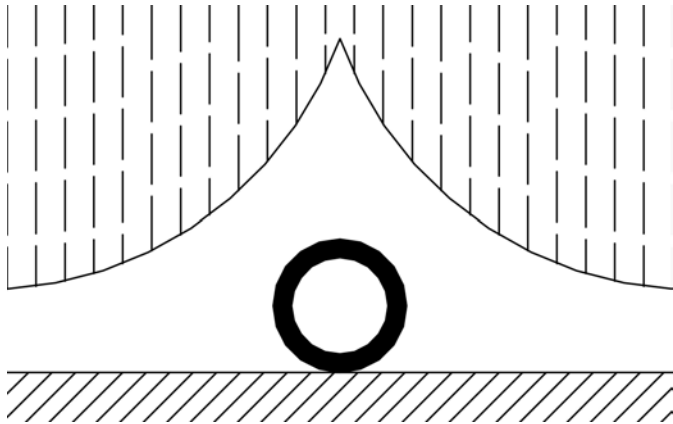

Protect the fusion area

Screening the fusion area can ensure a more even temperature distribution on the entire circumference of a pipe subject to direct sunlight. The pipe ends at the opposite end of the fusion areas should be sealed whenever possible to reduce to a minimum the cooling of the fusion surfaces which can be caused by wind.

Preparation of the fusion joint

The quality of the fusion process is governed by the care with which the preparatory work is carried out. This part of the procedure therefore deserves special attention.

Heating tool

Set the temperature of the heating element to 210 °C. Check the temperature. The fusion temperature should be between 200 °C and 220 °C.

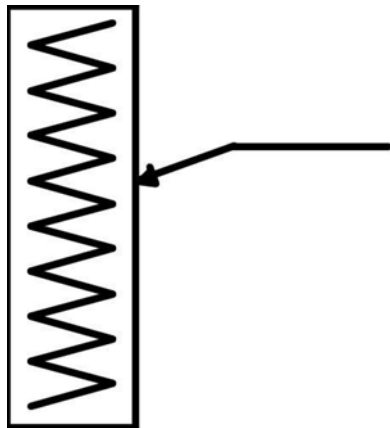

Check the temperature

Temperature of heating element 200 °C to 220 °C.

To test the thermostat, check temperature before commencing the fusion jointing. This is best carried out with the help of a digital thermometer. But only thermometers with a sensor for measuring surface temperature are suitable.

To ensure it is being maintained at the correct level, the fusion temperature should be checked from time to time during the jointing work. The temperature of the heating element is particularly sensitive to wind.

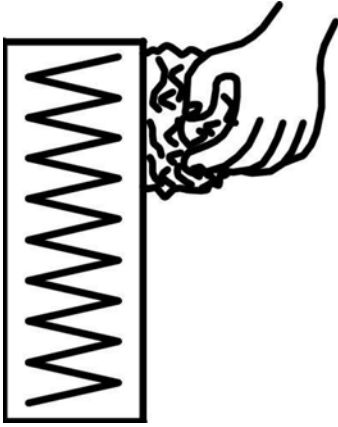

Clean the heating element

Clean the heating element with dry, clean paper before each fusion joint!

Protect the working surface of the heating element from becoming soiled. Clean both faces of the heating element with dry, lint-free paper before each fusion joint. Protect the heating element from wind, damage and soiling during the intervals between making fusion joints.

Planing and subsequent checking

Before machining the fusion surfaces, make sure that the tools and the work pieces are clean and grease-free even beyond the fusion zone; if necessary, clean with a cleaning fluid.

All the components clamped into the fusion jointing machine are planed simultaneously with the planer provided. The shavings should not be thicker than ≤ 0.2 mm. This step is completed when there is no unmachined area left on either of the parts to be joined.

This is normally the case when no more shavings come off the machined surface.

Remove any shavings which may have fallen into the pipe or fitting with e. g. a brush. The fusion surfaces should not be touched by hand under any circumstances. Otherwise they must be cleaned with cleaning fluid.

Once they have been machined, the parts are moved together until they touch. The gap between the two parts must not exceed 0.5 mm at any point.

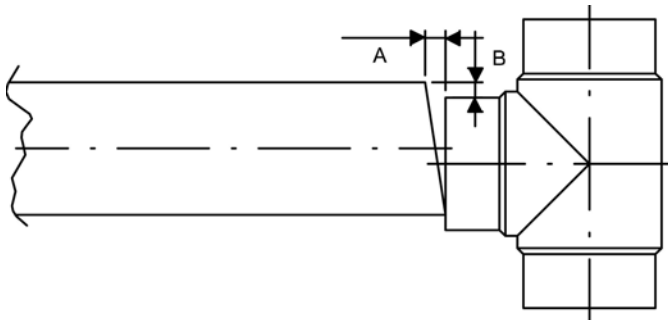

A max. gap: 0.5 mm

B max. displacement: 10 % of wall thickness

Check the wall alignment and gap

The alignment of the two parts should be checked at the same time. A possible misalignment on the outside must not exceed 10 % of the thickness of the wall. If this limit is exceeded, a better clamping position is to be sought, e. g. by rotating the pipe. In such a case, however, the surface must be re-planed.

Important: The fusion surfaces must be planed immediately prior to the jointing.

Setting the fusion pressure

Fusion jointing requires different pressures to be applied

during equalisation and jointing on the one hand and during the heat soak period on the other. Please see the following diagram.

Pressure/Time Diagram

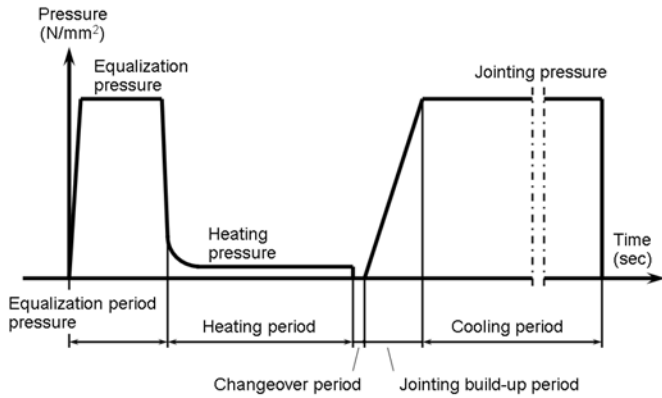

The specific jointing pressure required for equalisation and fusion can be found in the following table with the heating and cooling periods. The table lists the times for various wall thicknesses. Interpolate for intermediate values.

The force needed for equalisation and jointing (F_A) is given by the product of the fusion area and the specific jointing pressure ($F_A = A \cdot p$). The force (F_B) required to move the pipe must be added to this. ($F_{tot} = F_A + F_B$). This latter force includes the intrinsic resistance of the machine and the resistance of the axially mobile pipe or fitting clamped in it. The resistance of longer pipes should be reduced as far as possible by placing rollers beneath them. The kinetic force (F_B) should not exceed the jointing force (F_A).

Equalise and heat

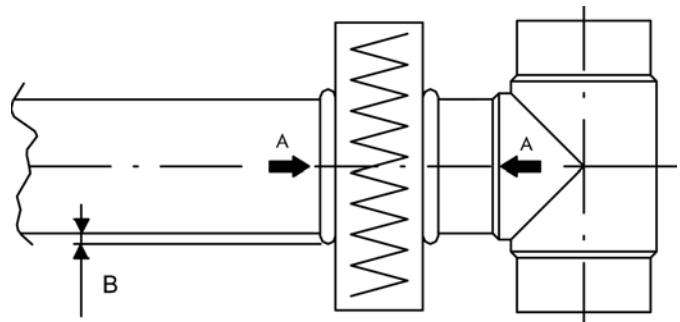

- A Contact force
- B Height of bead (see tabulated values)

Approximate values for butt fusion of PP 1)

Wall thickness (mm)	Equalisation at $p=0.10 \text{ N/mm}^2$ Height of bead (mm)	Heating time ²⁾ $p=0.01 \text{ N/mm}^2$ (sec)	Changeover time max. (sec)	Time to reach full jointing (sec)	Cooling time ²⁾ under jointing $p=0.10 \text{ N/mm}^2$ (min)
up to 4.5	0.5	up to 135	5	6	6
4.5 ... 7	0.5	135 ... 175	5 ... 6	6 .. 7	6 ... 12
7 ... 12	1.0	175 ... 245	6 ... 7	7 ... 11	12 ... 20
12 ... 19	1.0	245 ... 330	7 ... 9	11 ... 17	20 ... 30
19 ... 26	1.5	330 ... 400	9 ... 11	17 ... 22	30 ... 40
26 ... 37	2.0	400 ... 485	11 ... 14	22 ... 32	40 ... 55

1) in accordance with DVS 2207-11

2) The times are affected by the pipe wall thickness, the outside temperature and wind strength.

Determine the values to be set for equalisation and jointing on the basis of the information above, bearing in mind the instructions from the manufacturer of the fusion jointing machine before commencing the fusion process.

Fusion jointing procedure

Once it has attained the fusion temperature, position the heating element in the fusion jointing machine. Press the parts to be joined against the heating element with the force required for equalisation until the entire circumference of each of the jointing faces rests

completely against it and a bead (see the table) has formed. Reduce the equalisation pressure almost to 0 ($p \sim 0.01 \text{ N/mm}^2$). The heating time listed in the table is measured from this moment.

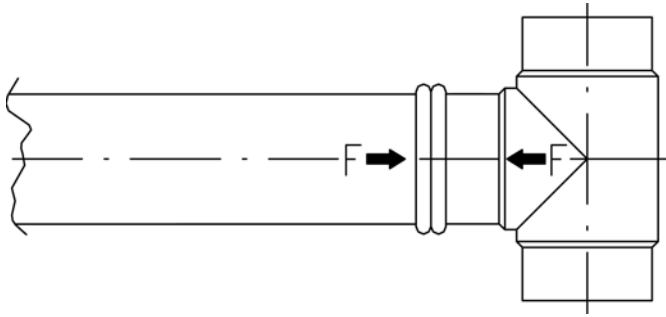

Join and cool

Leave parts in the fusion jointing machine at fusion pressure until the end of the cooling period!

Once the heating period has elapsed, remove the parts from the heating element which should then be removed without touching the jointing surfaces and push the parts together immediately. The changeover time must not exceed the value listed in the table. Pay particular attention during jointing that the parts be moved together swiftly until the surfaces are about to touch.

Then they should be moved together so that they are in contact along the entire circumference. Next the

pressure should be increased rapidly to the present jointing pressure within the period of time specified in the table. This pressure must be maintained during the entire cooling period. Adjustment may be necessary, especially shortly after the jointing pressure has been attained.

The jointed parts must stay in the fusion jointing machine under jointing pressure until the end of the cooling period specified in the table.

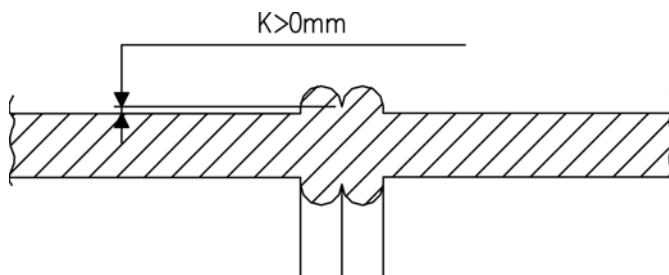

Fusion check

A bead should form around the entire circumference of the pipe. K in the diagram to the left should always be positive.

Carrying out the pressure test

All fusion joints must be allowed to cool completely before pressure testing, i.e. as a rule wait about 1 hour

after the last joint has been completed.

Joining technology

Fusion jointing of PP

Socket fusion jointing of PP piping systems

Socket fusion jointing method

In this form of fusion jointing, which requires heating tools, the pipe end is inserted into the socket of the fitting; no additional material is used. The pipe end and fitting socket are heated to fusion temperature using a heating bush and a heating spigot, respectively, and are then pushed together.

Details of the requirements for machines and equipment used for fusion jointing thermoplastics are contained in DVS 2208 Part 1.

The pipe end, fitting socket and heating tools correspond in such a way that the necessary jointing pressure is attained during jointing, resulting in a homogeneous joint.

Fusion jointing procedure

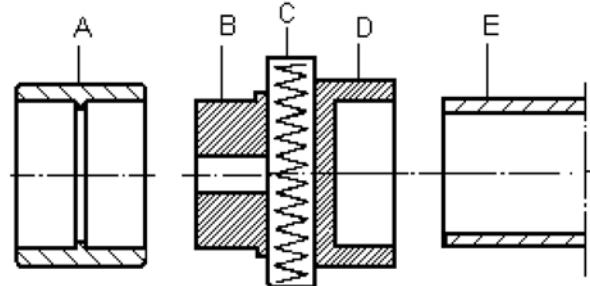

- A Fitting
- B Heating spigot
- C Heating element
- D Heating bush
- E Pipe

Heating

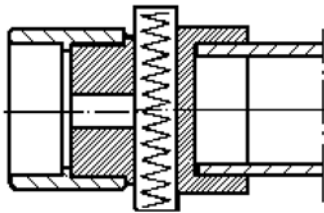

Finished joint

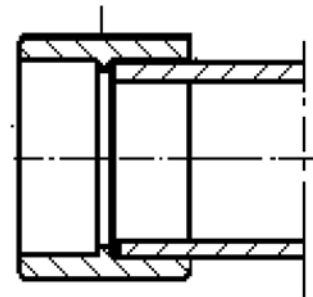

General requirements

The basic rule is that only similar materials can be fusion jointed, i. e. PP with PP.

In socket fusion, attention must be paid to the minimum

wall thicknesses of the pipes. The melt flow index of the pipes to be joined should lie within the following limits: 0.4 to 0.8 g/10 min. MFR 190/5 (Melt flow rate at 190 °C/5 kg).

Tools required

Apart from the tools normally used in plastic piping construction, such as pipe cutters or a saw with a cutting guide, the socket fusion jointing method requires certain special tools.

Important: The tools described here may be used for GF socket fusion fittings made of PE and PVDF as well as PP.

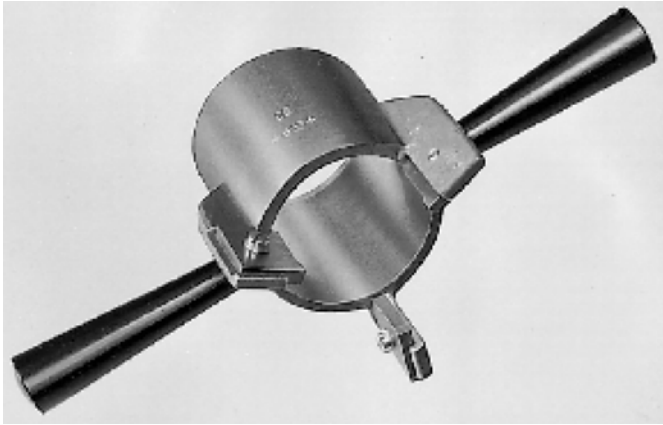

Pipe peeling and chamfering tool

This tool serves to calibrate the pipe end and to mark the length of the fusion joint. At the same time it removes the oxidised layer built up as a result of UV radiation, which would otherwise have a detrimental effect on the fusion joint. It is of paramount importance for high quality joints that the oxidised layer be removed.

Note: Further information on the fusion jointing equipment hire service and training courses are available from GF.

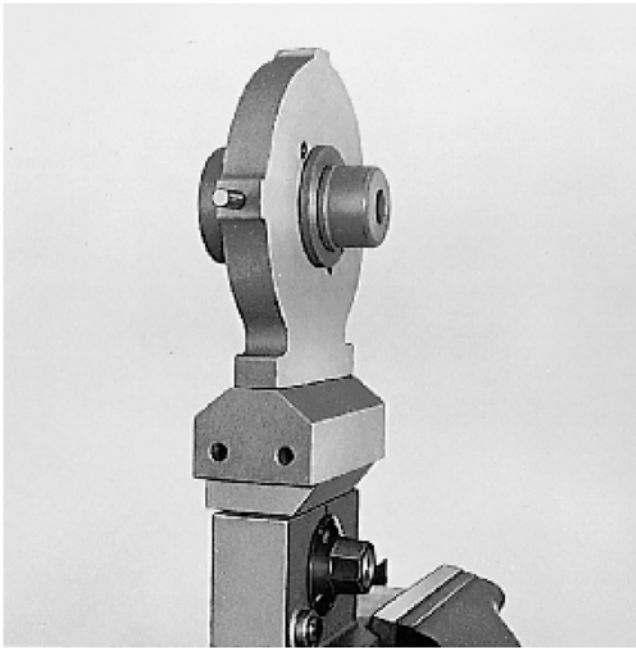

Heating element for manual fusion jointing

The element is heated electrically. The heating bush and spigot are removable. A separate pair is required for each pipe size.

Important: The surfaces of the heating tool which come into contact with the pipe or the fitting must have a non-stick coating.

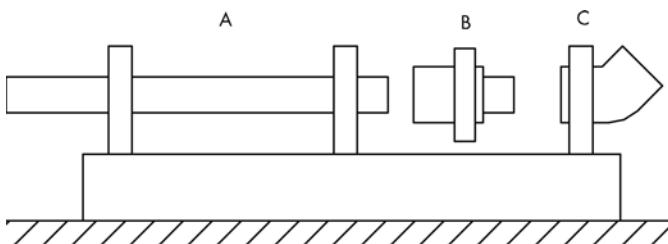

- A Pipe
- B Heating element
- C Fitting

Fusion jointing machine

A fusion jointing machine is recommended for fittings with a diameter of $d = 63$ mm or more. It is also better to use a machine for smaller joints if there is a large number to be made.

The machine should be set up and operated according to its manufacturer's instructions. The procedure detailed below (including the preparation) is for fusion jointing with the help of a manual jointing tool.

Preparation of the fusion joint

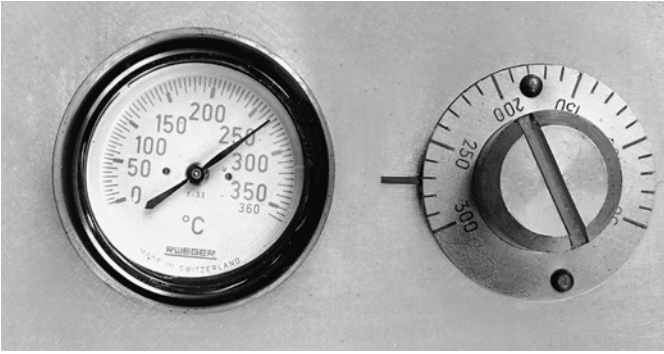

Set the temperature of the heating tool to 260 °C. Check the temperature. The fusion temperature must be between 250 °C and 270 °C. To test the thermostat, check the fusion temperature from time to time on the outside of the heating bush, using a fast acting thermoprobe or tempil sticks (253 °C or 274 °C). This is particularly important when working in strong wind.



Use a clean cloth or dry paper to clean the heating bush and the heating spigot. The tools must be cleaned after making each fusion joint.



Cut the pipe square using a cutter for plastic pipes and deburr the inside edges with a knife.

Make sure that the tools and pipes are clean and grease-free even beyond the fusion zone; if necessary, clean with a cleaning fluid.

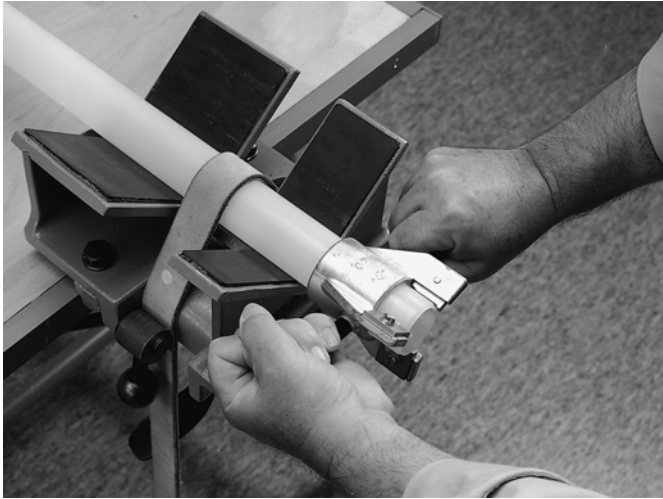

For pipes ranging in size from $d = 20$ to $d = 110$ mm peel the pipe end until the blades are flush with the pipe end.

Should ovality of the pipe prevent the peeling tool from being properly applied, the pipe must first be rounded (e. g. in a vice or with a screw clamp).

Use a scraper to complete the peeling of any area where ovality impairs the effectiveness of the peeling tool.

If the peeling tool can be pushed onto the pipe without

removing any material, then the dimensional accuracy of the pipe's outside diameter and of the peeling tool should be checked.

Contact GF for resharpening or replacing the blades. Should this work be carried out independently, use a mandrel gauge to adjust the blades to the following diameters.

Outside pipe diameter d (mm)	Peeled diameter mm	Peeling length l (mm)
16	15.85-15.95	13
20	19.85-19.95	14
25	24.85-24.95	16
32	31.85-31.95	18
40	39.75-39.95	20
50	49.75-49.95	23
63	62.65-62.95	27
75	74.65-74.95	31
90	89.65-89.95	35
110	109.55-109.95	41

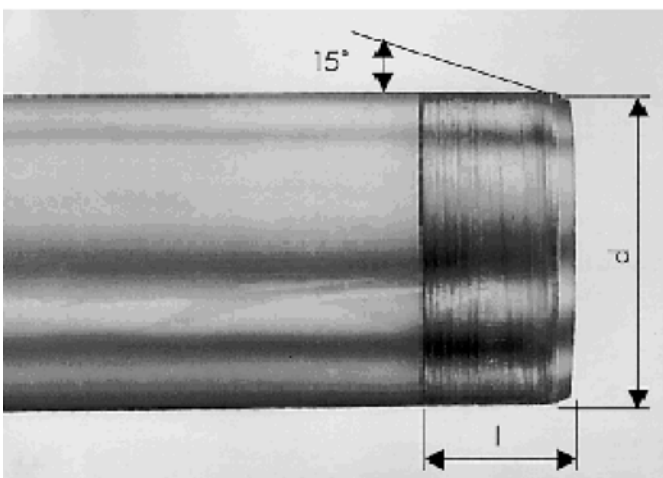

The peeling length l corresponds to the length of the peeling blades.

For pipes of diameter $d = 16$ mm, chamfer about 2 mm of the pipe end at an angle of 15° . Prepare about 15 mm of the pipe end with a scraper. Mark off the jointing length of 13 mm on the pipe.



Thoroughly clean the fitting socket with absorbent paper and cleaning fluid (e. g. Tangit cleaner). Use fresh paper each time.

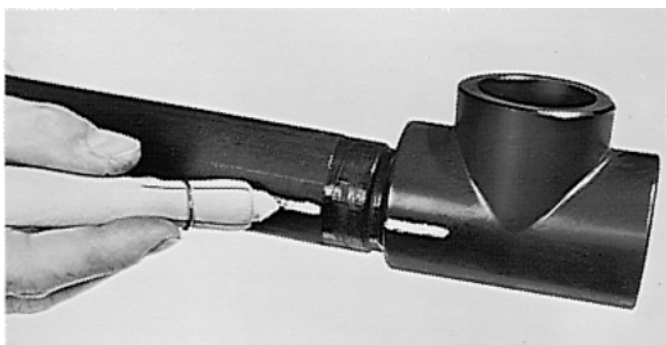

Mark the required position on both the pipe and the fitting before jointing.

Fusion jointing procedure

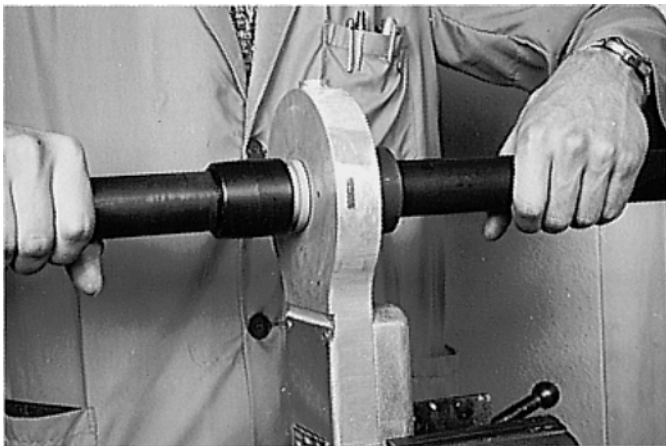

Heating

Quickly push first the fitting onto the heating spigot to the correct depth and then the pipe into the heating bush axially, without twisting, and hold firmly. 16 mm pipes should be inserted into the heating bush up to the mark previously made.

Pipes in size 20 mm should be inserted until the end of the peeled surface is flush with the edge of the heating bush. In fusion jointing machines fixed stops regulate this. The heating times in the table below are measured

from this point on. Fusion joints should not be used for pipes whose walls are thinner than those listed in the table.

Heating times and minimum wall thicknesses for socket fusion joints

Outside pipe diameter mm	Heating time PN10 SDR11	Heating time PN6 SDR17	Change (Max.time) sec	Cooling fixed sec	Cooling total min
-----------------------------	-------------------------------	------------------------------	-----------------------------	----------------------	----------------------

16	5	-	4	6	2
20	5	-	4	6	2
25	7	-	4	10	2
32	8	-	6	10	4
40	12	-	6	20	4
50	18	-	6	20	4
63	24	-	8	30	6
75	30	15	8	30	6
90	40	22	8	40	6
110	50	30	10	50	8

The temperature and heating time must be strictly observed.















Jointing (by hand)

Pull the fitting and pipe from the heating tools with a snap off action as soon as the heating period has elapsed. Paying attention to the alignment marks, immediately push them together axially without twisting. Hold them together for the same duration as the heating period.

Pressure testing

All fusion joints must be allowed to cool completely before pressure testing, i. e. as a rule wait about an hour after the last joint has been completed.

PP-H metric

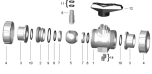
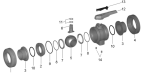
		Page
	PP-Pipes	42
	Socket Fusion Fittings	44
	Adaptor Fittings for Socket Fusion	49
	Unions for Socket Fusion	53
	Butt Fusion Fittings	54
	Adaptor Fittings for Butt Fusion	66
	Unions for Butt Fusion	68
	Adaptor Unions	71
	Union Ends	73
	Union Bushes	75
	Union Nuts	77
 DN10/15 - 50	Ball Valves 546	79
	Spare parts for ball valve type 546 PP-H (DN10/15-50)	96
	Spare parts for ball valve type 546 PP-H (DN65-100)	100



Ball Valves 323

103

Spare parts for metering ball valve type 323 PP-H

104

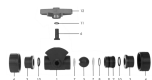

Ball Valves 343

105

Spare parts for ball valve type 343 PP-H

114

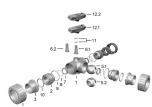

Diaphragm Valves 314

117

Spare parts for diaphragm valve type 314 PP-H

120



Diaphragm Valves 315

121

Spare parts for diaphragm valve type 315 PP-H

123



Diaphragm Valves 317

124

Spare parts for diaphragm valve type 317
(DN15-65) PP-H

126



Spare parts for diaphragm valve type 317
(DN80-150) PP-H

127



Diaphragm Valves 319

128

Spare parts for diaphragm valve type 319 PP-H

129



Butterfly valves

131



Spare parts for butterfly valves

142



Ball check valves

146

Spare parts for ball check valve type 360 PP-H

151



Wafer check valves

152

Spare parts for wafer check valve type 369 PP-H

155

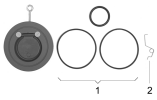

Strainers

156



Accessories Hand Operated Valves

157

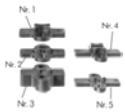

Accessories diaphragm valves type 314

160

PP-Pipes

67 48 07

Pipes S5/SDR11 (PN10)

Model:

- Material: Polypropylene (PP-H) DIN 8078
- Dimension: DIN 8077
- Colour: RAL 7032 gravel grey
- Length: Lengths of 5 m

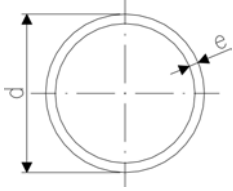

* In these two sizes, stiffeners Code No. 727 900 006 (20 x 1,9) ad 727 900 007 (25 x 2,3) must be used with socket fusion joints.

d [mm]	PN	Code	kg/m	e [mm]
16	10	167 480 710	0.080	1,8
*20	10	167 480 711	0.107	1,9
*25	10	167 480 712	0.164	2,3
32	10	167 480 713	0.261	2,9
40	10	167 480 714	0.412	3,7
50	10	167 480 715	0.638	4,6
63	10	167 480 716	1.010	5,8
75	10	167 480 717	1.410	6,8
90	10	167 480 718	2.030	8,2
110	10	167 480 719	3.010	10,0
125	10	167 480 720	3.910	11,4
140	10	167 480 721	4.870	12,7
160	10	167 480 722	6.380	14,6
180	10	167 480 723	8.070	16,4
200	10	167 480 724	9.950	18,2
225	10	167 480 725	12.600	20,5
250	10	167 480 726	15.500	22,7
280	10	167 480 727	19.400	25,4
315	10	167 480 728	24.600	28,6
355	10	167 480 729	31.200	32,2
400	10	167 480 730	39.600	36,3

27 90 00

Stiffeners, PP

- Used as support during d20 and d25 socket fusion jointing to prevent the pipe from collapsing during the heating and jointing process.

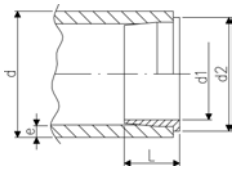

d [mm]	e [mm]	Code	SP	kg	L [mm]	d1 [mm]	d2 [mm]
20	1,9	727 900 006	-	0.002	10	14	18
25	2,3	727 900 007	-	0.003	11	18	23

67 48 10

Pipes S3,2/SDR7,4 (PN16)**Model:**

- Material: Polypropylene (PP-H) DIN 8078
- Dimension: DIN 8077
- Colour: RAL 7032 gravel grey
- Length: Lengths of 5 m
- For socket fusion without stiffeners

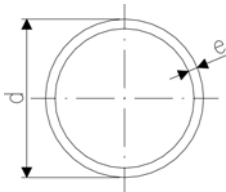

d [mm]	PN	Code	kg/m	e [mm]
20	16	167 481 028	0.148	2,8
25	16	167 481 029	0.230	3,5

67 48 06

Pipes S8,3/SDR17,6 (PN6)**Model:**

- Material: Polypropylene (PP-H) DIN 8078
- Dimension: DIN 8077
- Colour: RAL 7032 gravel grey
- Length: Lengths of 5 m

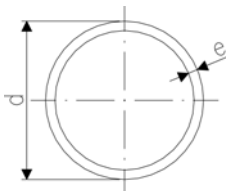

d [mm]	Code	kg/m	e [mm]
50	167 480 680	0.422	2,9
63	167 480 681	0.659	3,6
75	167 480 682	0.935	4,3
90	167 480 683	1.330	5,1
110	167 480 684	1.990	6,3
125	167 480 685	2.550	7,1
140	167 480 686	3.200	8,0
160	167 480 687	4.170	9,1
180	167 480 688	5.250	10,2
200	167 480 689	6.500	11,4
225	167 480 690	8.190	12,8
250	167 480 691	10.100	14,2
280	167 480 692	12.600	15,9
315	167 480 693	16.000	17,9
355	167 480 694	20.300	20,1
400	167 480 695	25.700	22,7

Socket Fusion Fittings

27 10 01

Elbows 90°, PP-H

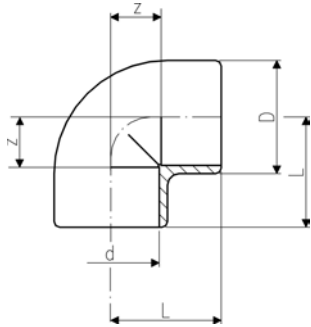

d [mm]	PN	Code	SP	kg	D [mm]	L [mm]	z [mm]
16	10	727 100 105	10	0.015	26	25	12
20	10	727 100 106	10	0.020	31	28	14
25	10	727 100 107	10	0.029	36	32	16
32	10	727 100 108	10	0.044	44	38	20
40	10	727 100 109	10	0.074	54	44	24
50	10	727 100 110	10	0.128	66	51	28
63	10	727 100 111	-	0.230	82	62	35
75	10	727 100 112	-	0.317	93	76	45
90	10	727 100 113	-	0.512	110	88	53
110	10	727 100 114	-	0.874	134	106	65

27 15 01

Elbows 45°, PP-H

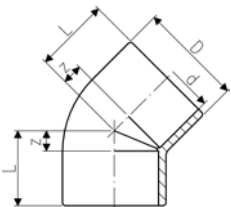

d [mm]	PN	Code	SP	kg	D [mm]	L [mm]	z [mm]
16	10	727 150 105	10	0.008	23	20	7
20	10	727 150 106	10	0.016	31	21	7
25	10	727 150 107	10	0.024	36	24	8
32	10	727 150 108	10	0.036	44	28	10
40	10	727 150 109	5	0.059	53	33	13
50	10	727 150 110	5	0.084	64	36	13
63	10	727 150 111	-	0.185	82	43	16
75	10	727 150 112	-	0.234	93	51	20
90	10	727 150 113	-	0.405	114	58	23
110	10	727 150 114	-	0.657	134	68	27

27 20 01

Tees 90° equal, PP-H

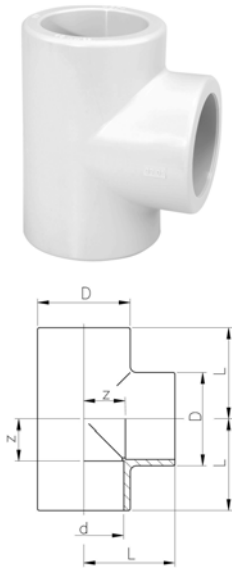

d [mm]	PN	Code	SP	kg	D [mm]	L [mm]	z [mm]
16	10	727 200 105	10	0.019	26	25	12
20	10	727 200 106	10	0.027	31	28	14
25	10	727 200 107	10	0.038	36	32	16
32	10	727 200 108	10	0.058	44	38	20
40	10	727 200 109	10	0.094	54	44	24
50	10	727 200 110	5	0.158	66	51	28
63	10	727 200 111	-	0.288	82	62	35
75	10	727 200 112	-	0.409	93	76	45
90	10	727 200 113	-	0.739	114	88	53
110	10	727 200 114	-	1.231	134	106	65

27 91 01

Sockets equal, PP-H

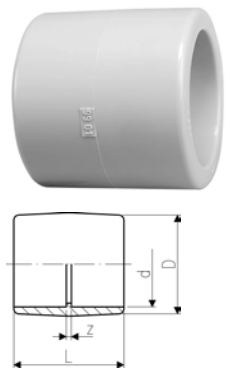

d [mm]	PN	Code	SP	kg	D [mm]	L [mm]	z [mm]
16	10	727 910 105	-	0.010	26	33	7
20	10	727 910 106	10	0.013	31	35	7
25	10	727 910 107	10	0.019	36	39	7
32	10	727 910 108	10	0.026	44	43	7
40	10	727 910 109	10	0.042	54	48	8
50	10	727 910 110	10	0.075	66	54	8
63	10	727 910 111	5	0.129	82	62	8
75	10	727 910 112	-	0.144	93	70	8
90	10	727 910 113	-	0.257	112	81	11
110	10	727 910 114	-	0.405	134	96	14

27 91 09

Barrel Nipples, PP-H

Model:

- With fusion sockets on both sides
- For the shortest possible distance between fittings
- Overall length L = 2 x fusion length

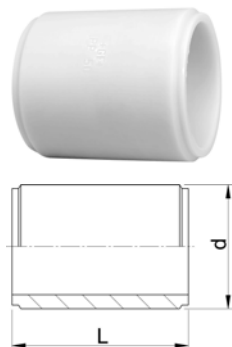

d [mm]	PN	Code	SP	kg	L [mm]
20	10	727 910 906	10	0.005	37
25	10	727 910 907	10	0.006	41
32	10	727 910 908	10	0.010	45
40	10	727 910 909	10	0.017	50
50	10	727 910 910	10	0.029	55
63	10	727 910 911	5	0.058	64
75	10	727 910 912	-	0.096	76
90	10	727 910 913	-	0.167	90
110	10	727 910 914	2	0.305	108

27 91 03

Reducers, PP-H**Note:**

- * Fusion spigot and socket

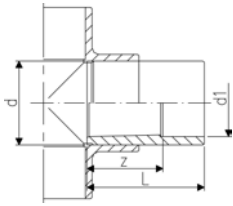
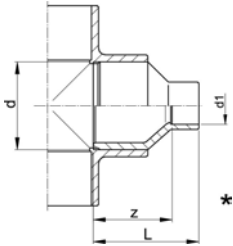

d [mm]	d1 [mm]	PN	Code	SP	kg	L [mm]	z [mm]
20	16	10	727 910 334	10	0.009	35	22
25	16	10	727 910 338	10	0.010	38	25
25	20	10	727 910 337	10	0.014	37	23
32	20	10	727 910 342	10	0.016	43	29
32	25	10	727 910 341	10	0.020	43	27
*40	20	10	727 910 348	10	0.022	48	34
*40	25	10	727 910 347	10	0.026	48	32
40	32	10	727 910 346	10	0.031	48	30
*50	20	10	727 910 355	10	0.034	54	40
*50	25	10	727 910 354	10	0.035	54	38
*50	32	10	727 910 353	10	0.040	54	36
50	40	10	727 910 352	10	0.047	54	34
*63	25	10	727 910 361	5	0.058	64	48
*63	32	10	727 910 360	10	0.061	64	46
*63	40	10	727 910 359	5	0.068	64	44
63	50	10	727 910 358	5	0.082	64	41
75	63	10	727 910 364	-	0.098	62	35
*90	63	10	727 910 371	-	0.181	88	61
90	75	10	727 910 370	-	0.134	70	39
110	90	10	727 910 376	-	0.247	81	46

27 96 01

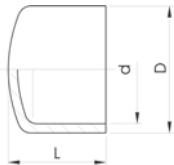
End Caps, PP-H

d [mm]	PN	Code	SP	kg	D [mm]	L [mm]
16	10	727 960 105	10	0.008	25	20
20	10	727 960 106	10	0.010	30	27
25	10	727 960 107	10	0.015	36	30
32	10	727 960 108	10	0.024	44	34
40	10	727 960 109	10	0.036	53	38
50	10	727 960 110	10	0.061	65	44
63	10	727 960 111	5	0.098	80	51
75	10	727 960 112	-	0.146	91	65
90	10	727 960 113	-	0.273	111	77
110	10	727 960 114	-	0.417	137	93

27 79 02

Flange Adapter, PP-H Joining face flat/serrated

Model:

- Counterpart: Flange Adaptor flat/serrated or with O-ring groove
- Connection: according to EN ISO 15494-1
- Gasket: Flange gasket EPDM No. 48 44 08, FPM No. 49 44 08
- Flanges: PP with steel core, No. 27 70 02, PP-V, No. 27 70 04

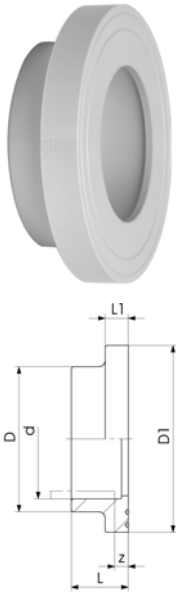

d [mm]	PN	Code	SP	kg	D [mm]	D1 [mm]	L [mm]	L1 [mm]	z [mm]
20	10	727 790 206	10	0.011	27	45	19	7	5
25	10	727 790 207	10	0.022	33	58	21	9	5
32	10	727 790 208	10	0.033	41	68	23	10	5
40	10	727 790 209	10	0.046	50	78	25	11	5
50	10	727 790 210	5	0.062	61	88	28	12	5
63	10	727 790 211	5	0.090	76	102	32	14	5
75	10	727 790 212	-	0.163	90	122	36	16	5
90	10	727 790 213	-	0.233	108	138	42	17	7
110	10	727 790 214	-	0.319	131	158	48	18	7

27 79 02

Flange Adaptor, PP-H Joining face serrated ANSI

Model:

- Counterpart: Flange adaptor serrated
- Gasket: Flange gasket EPDM No. 48 44 05, FPM No. 49 44 05
- Flanges: PP with steel core, No. 27 70 02, PP-V, No 27 70 04

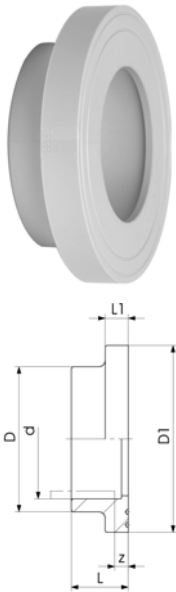

d [mm]	PN	Code	SP	kg	D [mm]	D1 [mm]	L [mm]	L1 [mm]	z [mm]
25	10	727 790 257	10	0.019	33	54	21	7	5
32	10	727 790 258	10	0.028	41	63	23	7	5
40	10	727 790 259	10	0.040	50	73	25	8	5
50	10	727 790 260	5	0.053	61	82	28	8	5
90	10	727 790 263	-	0.233	108	133	36	16	5

27 81 01

Flange Adaptors, PP-H Jointing face with O-ring groove

Model:

- Counterpart: Flange adaptor flat/serrated, No. 27 79 02
- Gasket: O-ring EPDM No. 48 41 01, FPM No. 49 41 01
- Flanges: PP with steel core, No. 27 70 02 (mm) or No. 27 70 12 (ANSI), PP-V, No. 27 70 04

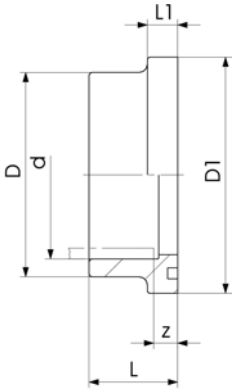

d [mm]	PN	Code	SP	kg	D [mm]	D1 [mm]	L [mm]	L1 [mm]	z [mm]
20	10	727 810 106	10	0.007	27	34	22	9	8
25	10	727 810 107	10	0.012	33	41	24	10	8
32	10	727 810 108	10	0.018	41	50	26	10	8
40	10	727 810 109	10	0.027	50	61	30	13	10
50	10	727 810 110	10	0.040	61	73	33	13	10
63	10	727 810 111	5	0.070	76	90	37	14	10
75	10	727 810 112	-	0.105	90	106	40	15	10
90	10	727 810 113	-	0.170	108	125	47	16	12
110	10	727 810 114	2	0.263	131	150	55	18	13

27 80 00

Outlet Flange Adapter, PP-H Jointing Face flat

Model:

- With fusion socket metric
- Suitable for wafer check valves Type 369
- To be installed on the outlet side of the valve
- Use flanges PP-V 27 70 04

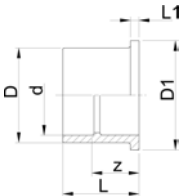

d [mm]	DN [mm]	PN	Code	SP	kg	D [mm]	D1 [mm]	L [mm]	L1 [mm]	z [mm]
40	32	6	727 800 009	-	0.060	50	78	55	11	35
50	40	6	727 800 010	-	0.080	61	88	61	12	38
63	50	6	727 800 011	-	0.130	76	102	69	14	41
75	65	6	727 800 012	-	0.160	90	122	79	16	49
90	80	6	727 800 013	-	0.270	107	138	100	17	65
110	100	6	727 800 014	-	0.480	130	158	105	18	62

Adaptor Fittings for Socket Fusion

27 91 30

Adaptor Sockets, PP-H metric - BS Inch

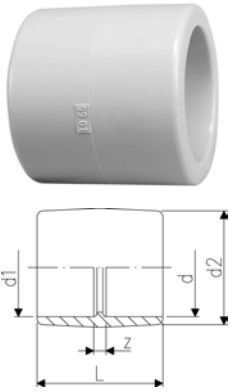

Model:

- With fusion socket metric and BS Inch (ASTM)

d [mm]	d1 [inch]	PN	Code	SP	kg	d2 [mm]	L [mm]	z [mm]
20	¾	10	727 913 006	-	0.013	31	35	7
25	¾	10	727 913 007	-	0.010	36	39	7
32	1	10	727 913 008	-	0.025	44	43	7
40	1 ¼	10	727 913 009	-	0.040	54	48	8
50	1 ½	10	727 913 010	-	0.100	66	54	8
63	2	10	727 913 011	-	0.130	82	62	8
90	3	10	727 913 013	-	0.260	112	81	10
110	4	10	727 913 014	-	0.389	134	96	12

27 91 02

Adaptor Sockets, PP-H metric - Rp

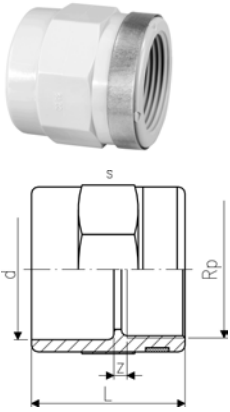

Model:

- With fusion socket metric and parallel female thread Rp, reinforced
- Connection to plastic or metal
- Reinforcing ring stainless (A2)
- Do not use thread sealing pastes that are harmful to PP

d [mm]	Rp [inch]	PN	Code	SP	kg	L [mm]	s [mm]	z [mm]
20	¾	10	727 910 205	10	0.017	35	32	7
20	½	10	727 910 206	10	0.017	40	32	7
25	¾	10	727 910 207	10	0.023	42	36	7
32	1	10	727 910 208	10	0.038	48	46	7
40	1 ¼	10	727 910 209	10	0.056	53	55	7
50	1 ½	10	727 910 210	10	0.089	54	65	9
63	2	10	727 910 211	5	0.137	62	80	9

27 91 05

Adaptor Nipples, PP-H metric - R

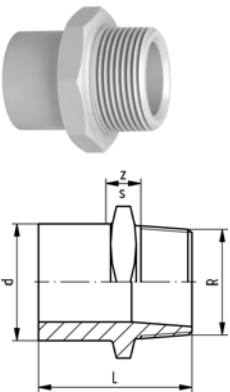

Model:

- With fusion spigot metric and BSP tapered male thread
- Connection to plastic thread only
- Do not use thread sealing pastes that are harmful to PP

d [mm]	R [inch]	PN	Code	SP	kg	L [mm]	s [mm]	z [mm]
16	¾	10	727 910 505	10	0.008	37	27	13
20	½	10	727 910 506	10	0.012	42	32	13
25	¾	10	727 910 507	10	0.016	46	36	13
32	1	10	727 910 508	10	0.027	52	46	12
40	1 ¼	10	727 910 509	10	0.041	56	55	14
50	1 ½	10	727 910 510	10	0.062	60	65	15
63	2	10	727 910 511	5	0.100	69	80	16

27 91 42

Adaptor Sockets, PP-H metric - NPT

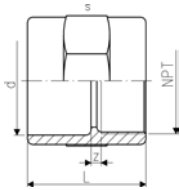

Model:

- With fusion socket metric and NPT tapered female thread, reinforced
- Connection to plastic or metal
- Reinforcing ring stainless (A2)
- Do not use thread sealing pastes that are harmful to PP

d [mm]	NPT [inch]	PN	Code	SP	kg	L [mm]	s [mm]	z [mm]
20	3/8	10	727 914 266	10	0.017	40	32	7
25	1/2	10	727 914 267	10	0.023	42	36	7
32	1	10	727 914 268	10	0.038	48	46	7
40	1 1/4	10	727 914 269	10	0.056	53	55	7
50	1 1/2	10	727 914 270	10	0.092	54	65	9
63	2	10	727 914 271	5	0.146	62	80	9

27 91 45

Adaptor Nipples, PP-H metric - NPT

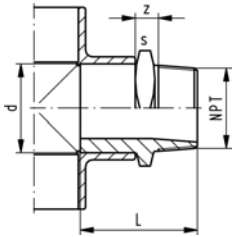

Model:

- With fusion spigot metric and NPT tapered male thread
- Connection to plastic thread only
- Do not use thread sealing pastes that are harmful to PP

d [mm]	NPT [inch]	PN	Code	SP	kg	s [mm]	L [mm]	z [mm]
16	3/8	10	727 914 555	10	0.008	27	37	13
20	1/2	10	727 914 556	10	0.012	32	42	13
25	3/4	10	727 914 557	10	0.016	36	46	13
32	1	10	727 914 558	10	0.027	46	52	12
40	1 1/4	10	727 914 559	10	0.041	55	56	14
50	1 1/2	10	727 914 560	10	0.100	65	60	15
63	2	10	727 914 561	5	0.185	80	69	16

27 91 04

Reducing Bushes, PP-H metric - Rp

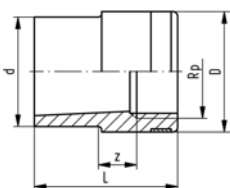

Model:

- With fusion spigot metric and BSP parallel female thread, reinforced
- Connection to plastic or metal
- Reinforcing ring stainless (A2)
- Do not use thread sealing pastes that are harmful to PP

d [mm]	Rp [inch]	PN	Code	SP	kg	L [mm]	z [mm]
20	¾	10	727 910 433	10	0.008	36	7
20	¾	10	727 910 434	10	0.011	36	7
25	½	10	727 910 437	10	0.015	45	6
32	¾	10	727 910 441	10	0.023	47	8
40	1	10	727 910 446	10	0.039	53	9
50	1 ¼	10	727 910 452	10	0.061	55	10

27 10 02

Elbows 90°, PP-H metric - Rp

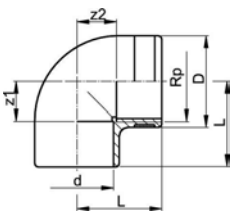

Model:

- With fusion socket metric and parallel female thread Rp, reinforced
- Connection to plastic or metal
- Reinforcing ring stainless (A2)
- Do not use thread sealing pastes that are harmful to PP

d [mm]	Rp [inch]	PN	Code	SP	kg	D [mm]	L [mm]	z1 [mm]	z2 [mm]
20	½	10	727 100 206	10	0.022	30	28	14	14
25	¾	10	727 100 207	10	0.029	35	32	16	16
32	1	10	727 100 208	10	0.054	44	38	20	20
40	1 ¼	10	727 100 209	10	0.087	54	44	24	24

27 20 02

Tees 90°, PP-H metric - Rp

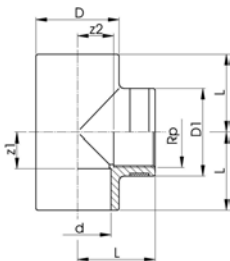

Model:

- Line, with fusion socket metric
- Branch, with BSP parallel female thread Rp, reinforced
- Connection to plastic or metal
- Reinforcing ring stainless (A2)
- Do not use thread sealing pastes that are harmful to PP

d [mm]	Rp [inch]	PN	Code	SP	kg	D [mm]	L [mm]	z1 [mm]	z2 [mm]
20	½	10	727 200 206	10	0.030	31	28	14	14
25	¾	10	727 200 207	10	0.042	36	32	16	16
32	1	10	727 200 208	10	0.069	44	38	20	20
40	1 ¼	10	727 200 209	10	0.107	54	44	24	24

27 96 04

Hose Connectors, PP-H metric

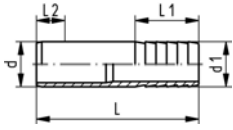

Model:

- With socket fusion spigot metric and parallel hose connection

d [mm]	d1 [mm]	PN	Code	SP	kg	L [mm]	L1 [mm]	L2 [mm]	
20	20	10	727 960 406	10	0.009	78	27	14	
25	25	10	727 960 407	10	0.015	91	36	16	
32	32	10	727 960 408	10	0.026	100	36	18	
40	40	10	727 960 409	10	0.040	104	42	20	
50	50	10	727 960 410	10	0.061	90	48	23	
63	60	10	727 960 411	5	0.096	100	50	27	

67 05 02

Tank Adaptors, PP

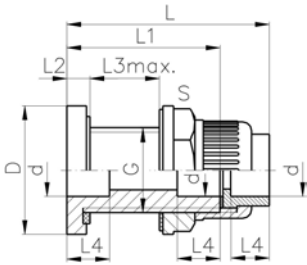

Model:

- End connection: Union with fusion socket metric
- Gasket: flat gasket EPDM

d [mm]	Code	SP	kg	G [inch]	D [mm]	L [mm]	L1 [mm]	L2 [mm]	L3 max [mm]	L4 [mm]	s [mm]	Diameter of bore in tank side [mm]
20	167 050 226	-	0.083	1	56	89	67	11	30	16	38	35
25	167 050 227	-	0.135	1 ¼	65	96	72	12	32	18	47	43
32	167 050 228	-	0.158	1 ½	70	100	75	12	33	20	53	49
40	167 050 229	-	0.305	2	95	106	78	12	32	22	75	61
50	167 050 230	-	0.325	2 ¼	95	112	82	13	32	25	75	67
63	167 050 231	-	0.325	2 ¾	115	112	87	13	33	29	101	83

Unions for Socket Fusion

EPDM 27 51 01
FPM 27 52 01

Unions, PP-H metric

Model:

- With fusion sockets metric
- D75-110 with new thread geometry, now rated PN10 up to d110
- Jointing face: with O-ring groove
- **For the dimensions d75-110 please see instructions for the installation**

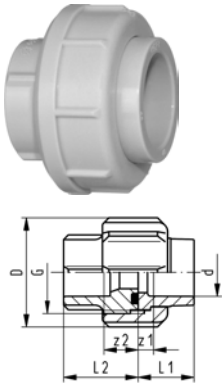

d [mm]	PN	EPDM Code	FPM Code	SP	kg	D [mm]	G [inch]	L1 [mm]	L2 [mm]	z [mm]	z1 [mm]
16	10	727 510 155	727 520 155	10	0.020	35	3/4	18	24	5	11
20	10	727 510 156	727 520 156	10	0.038	48	1	19	26	5	12
25	10	727 510 157	727 520 157	10	0.062	58	1 1/4	21	28	5	12
32	10	727 510 158	727 520 158	10	0.079	65	1 1/2	23	30	5	12
40	10	727 510 159	727 520 159	10	0.137	79	2	25	34	5	14
50	10	727 510 160	727 520 160	10	0.180	91	2 1/4	28	39	5	16
63	10	727 510 161	727 520 161	-	0.312	111	2 3/4	32	47	5	20
75	10	727 510 172	727 520 172	-	0.450	135	S107,5x3,6	36	51	5	20
90	10	727 510 173	727 520 173	-	0.645	158	S127,5x3,6	42	55	7	20
110	10	727 510 174	727 520 174	-	1.020	188	S152,5x3,6	49	54	7	12

27 51 30

Adapter Unions, PP-H metric - Inch BS (ASTM)

Model:

- With fusion sockets metric
- Jointing face: with O-ring groove

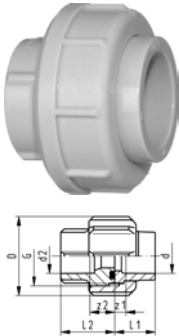

d [mm]	d2	PN	Code	SP	kg	D [mm]	G [inch]	L1 [mm]	L2 [mm]	z1 [mm]	z2 [mm]
20	1/2	10	727 513 006	-	0.036	48	1	19	26	5	12
25	3/4	10	727 513 007	-	0.060	58	1 1/4	21	28	5	12
32	1	10	727 513 008	-	0.079	65	1 1/2	23	30	5	12
40	1 1/4	10	727 513 009	-	0.112	79	2	25	34	5	14
50	1 1/2	10	727 513 010	-	0.182	91	2 1/4	28	39	5	16
63	2	10	727 513 011	-	0.315	111	2 3/4	32	47	5	20

Butt Fusion Fittings

Bends 90°, PP-H S5/SDR11

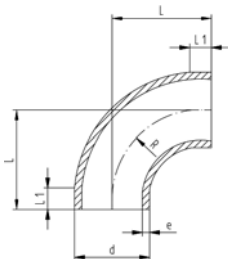

Model:

- Bends with new geometry
- Injection moulding process optimised for Beta-(β)-PP
- Conventional butt-welding according to DVS 2207 part 1
- IR = Infrared-(IR Plus[®]) compatible. Please choose fusion parameters: PP-H

¹ PP-R

d [mm]	FM	Code	SP	kg	L [mm]	L1 [mm]	R [mm]	e [mm]
20	--	727 018 481	25	0.005	28	5	22	1,9
25	--	727 018 482	10	0.009	33	7	27	2,3
32	--	727 018 483	10	0.017	41	7	35	2,9
40	--	727 018 484	5	0.036	52	10	44	3,7
50	--	727 018 485	5	0.066	63	10	55	4,6
63	--	727 018 486	5	0.126	77	10	69	5,8
75	IR	727 018 612	-	0.229	100	20	90	6,8
90	IR	727 018 613	-	0.335	100	20	90	8,2
110	IR	727 018 614	-	0.607	141	25	130	10,0
125	IR	727 018 490	-	0.790	140	15	125	11,4
140	IR	727 018 491	-	1.080	155	15	140	12,7
160	IR	727 018 492	-	1.600	175	15	160	14,6
180	IR	727 018 493	-	2.600	195	15	180	16,4
200	IR	727 018 494	-	3.130	215	15	200	18,2
225	IR	727 018 495	-	4.230	245	20	225	20,5
250	--	727 018 521	-	6.450	256	48	232	22,7
280	--	727 018 522	-	9.500	286	48	262	25,4
315	--	727 018 523	-	12.800	321	48	297	28,6
¹ 355	--	727 018 574	-	19.400	380	15	300	32,2
¹ 400	--	727 018 575	-	28.500	435	25	300	36,3



Bend 90°, PP-H S8,3/SDR17,6

Model:

- Conventional butt-welding according to DVS 2207 part 1
- IR = Infrared-(IR Plus®) compatible. Please choose fusion parameters: PP-H
- Bends with new geometry
- Injection moulding process optimised for Beta-(β)-PP

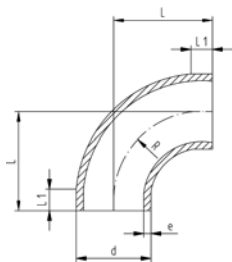

¹ PP-R

d [mm]	FM	Code	SP	kg	L [mm]	L1 [mm]	e [mm]
50	--	727 018 435	-	0.047	63	10	2,9
63	--	727 018 436	-	0.089	77	10	3,6
75	IR	727 018 637	-	0.161	100	20	4,3
90	IR	727 018 638	-	0.229	100	20	5,1
110	IR	727 018 639	-	0.486	141	25	6,3
125	IR	727 018 440	-	0.590	140	15	7,1
140	IR	727 018 441	-	0.820	155	15	8,0
160	IR	727 018 442	-	1.200	175	15	9,1
180	IR	727 018 443	-	1.690	195	15	10,2
200	IR	727 018 444	-	2.300	215	15	11,4
225	IR	727 018 445	-	3.200	245	20	12,8
250	--	727 018 421	-	4.400	256	48	14,2
280	--	727 018 422	-	6.200	286	48	15,9
315	--	727 018 423	-	8.800	321	48	17,9
¹ 355	--	727 018 549	-	13.300	380	15	20,1
¹ 400	--	727 018 550	-	18.600	435	25	22,7

27 10 85

Elbows 90°, PP-H S5/SDR11

Model:

- Conventional butt-welding according to DVS 2207 part 1
- IR = Infrared-(IR Plus®) compatible. Please choose fusion parameters: PP-H

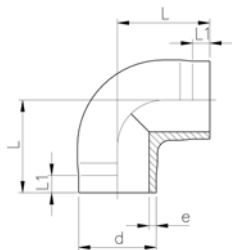

d [mm]	FM	Code	SP	kg	L [mm]	L1 [mm]	e [mm]
20	IR	727 108 506	10	0.007	38	25	1,9
25	IR	727 108 507	10	0.012	42	26	2,3
32	IR	727 108 508	10	0.022	46	27	2,9
40	IR	727 108 509	10	0.044	51	22	3,7
50	IR	727 108 510	10	0.077	58	23	4,6
63	IR	727 108 511	-	0.138	66	21	5,8

27 15 85

Elbows 45°, PP-H S5/SDR11**Model:**

- Conventional butt-welding according to DVS 2207 part 1
- IR = Infrared-(IR Plus®) compatible. Please choose fusion parameters: PP-H

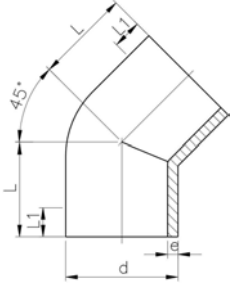

d [mm]	FM	Code	SP	kg	L [mm]	L1 [mm]	e [mm]
20	IR	727 158 506	10	0.006	32	24	1,9
25	IR	727 158 507	10	0.010	34	25	2,3
32	IR	727 158 508	10	0.020	36	25	2,9
40	IR	727 158 509	10	0.037	39	25	3,7
50	IR	727 158 510	10	0.054	42	26	4,6
63	IR	727 158 511	10	0.097	47	29	5,8
75	IR	727 158 512	-	0.135	49	29	6,8
90	IR	727 158 513	-	0.224	57	34	8,2
110	IR	727 158 514	-	0.415	70	43	10,0
125	IR	727 158 515	-	0.607	79	48	11,4
140	IR	727 158 516	-	0.860	88	55	12,7
160	IR	727 158 517	-	1.260	100	60	14,6
200	IR	727 158 519	-	2.460	124	75	18,2
225	IR	727 158 520	-	3.400	140	85	20,5

27 15 85

Elbows 45°, PP-H S8,3/SDR17,6**Model:**

- Conventional butt-welding according to DVS 2207 part 1
- IR = Infrared-(IR Plus®) compatible. Please choose fusion parameters: PP-H
- Machined from S5/SDR11

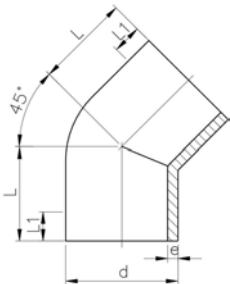

d [mm]	FM	Code	SP	kg	L [mm]	L1 [mm]	e [mm]
50	--	727 158 535	10	0.042	42	26	2,9
63	IR	727 158 536	-	0.083	47	29	3,6
75	IR	727 158 537	-	0.128	49	29	4,3
90	IR	727 158 538	-	0.208	57	34	5,1
110	IR	727 158 539	-	0.398	70	43	6,3
125	IR	727 158 540	-	0.570	79	48	7,1
140	IR	727 158 541	-	0.825	88	55	8,0
160	IR	727 158 542	-	1.190	100	60	9,1
200	IR	727 158 544	-	2.300	124	75	11,4
225	IR	727 158 545	-	3.200	140	85	12,8

27 20 85

Tee 90° equal, S5/SDR11**Model:**

- Material: Polypropylene (PP-H)
- Conventional butt-welding according to DVS 2207 part 1
- IR = Infrared-(IR Plus®) compatible. Please choose fusion parameters: PP-H

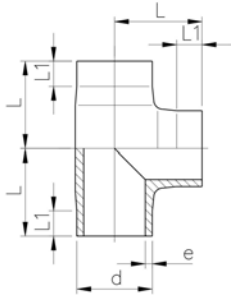
¹ PP-R

d [mm]	FM	Code	SP	kg	L [mm]	L1 [mm]	e [mm]
20	IR	727 208 506	10	0.011	38	24	1,9
25	IR	727 208 507	10	0.018	42	26	2,3
32	IR	727 208 508	10	0.030	46	26	2,9
40	IR	727 208 509	10	0.059	51	22	3,7
50	IR	727 208 510	10	0.103	58	22	4,6
63	IR	727 208 511	-	0.200	66	21	5,8
75	IR	727 208 512	-	0.300	75	20	6,8
90	IR	727 208 513	-	0.530	90	20	8,2
110	IR	727 208 514	-	0.950	110	20	10,0
125	IR	727 208 515	-	1.400	125	25	11,4
140	IR	727 208 516	-	1.980	140	28	12,7
160	IR	727 208 517	-	2.900	160	28	14,6
180	IR	727 208 568	-	4.430	194	74	16,4
200	IR	727 208 519	-	5.570	200	35	18,2
225	IR	727 208 520	-	7.820	220	35	20,5
250	--	727 208 571	-	12.480	276	92	22,7
280	--	727 208 572	-	17.250	318	110	25,4
315	--	727 208 573	-	24.060	353	118	28,6
¹ 355	--	727 208 574	-	31.100	345	100	32,2
¹ 400	--	727 208 575	-	38.000	360	102	36,3

27 20 85

Tees 90°, equal, PP-H S8,3/SDR17,6**Model:**

- Conventional butt-welding according to DVS 2207 part 1
- IR = Infrared-(IR Plus®) compatible. Please choose fusion parameters: PP-H

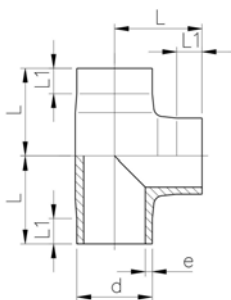
¹ PP-R

d [mm]	FM	Code	SP	kg	L [mm]	L1 [mm]	e [mm]
50	--	727 208 535	-	0.090	59	26	2,9
63	IR	727 208 536	-	0.160	71	31	3,6
75	IR	727 208 537	-	0.263	85	28	4,3
90	IR	727 208 538	-	0.438	100	23	5,1
110	IR	727 208 539	-	0.763	120	43	6,3
125	IR	727 208 540	-	1.066	125	30	7,1
140	IR	727 208 541	-	1.449	140	35	8,0
160	IR	727 208 542	-	2.240	160	43	9,1
180	IR	727 208 543	-	3.090	194	70	10,2
200	IR	727 208 544	-	4.360	210	70	11,4
225	IR	727 208 545	-	6.030	235	82	12,8
250	--	727 208 546	-	8.610	276	92	14,2
280	--	727 208 547	-	11.660	318	110	15,9
315	--	727 208 548	-	16.230	353	118	17,9
¹ 355	--	727 208 549	-	21.000	345	100	20,1
¹ 400	--	727 208 550	-	26.000	360	102	22,7

27 20 83

Tee 90° reduced, S5/SDR11**Model:**

- Material: Polypropylene (PP-H)
- Conventional butt-welding according to DVS 2207 part 1
- IR = Infrared-(IR Plus®) compatible. Please choose fusion parameters: PP-H

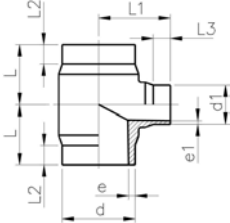

d	d1	FM	Code	SP	kg	L	L1	L2	L3	e	e1
[mm]	[mm]					[mm]	[mm]	[mm]	[mm]	[mm]	[mm]
63	32	IR	727 208 351	-	0.160	65	70	25	25	5,8	2,9
63	50	IR	727 208 352	-	0.170	65	70	25	25	5,8	4,6
75	32	IR	727 208 353	-	0.240	70	75	25	25	6,8	2,9
75	50	IR	727 208 354	-	0.250	70	75	25	25	6,8	4,6
75	63	IR	727 208 355	-	0.260	70	75	25	25	6,8	5,8
90	50	IR	727 208 357	-	0.410	80	85	25	25	8,2	4,6
90	63	IR	727 208 358	-	0.420	80	85	25	25	8,2	5,8
90	75	IR	727 208 359	-	0.440	80	85	25	25	8,2	6,8
110	32	IR	727 208 360	-	0.650	90	95	30	25	10	2,9
110	50	IR	727 208 361	-	0.670	90	95	30	25	10,0	4,6
110	63	IR	727 208 362	-	0.680	90	95	30	25	10,0	5,8
110	75	IR	727 208 363	-	0.690	90	95	30	25	10,0	6,8
110	90	IR	727 208 364	-	0.700	90	95	30	25	10,0	8,2
160	63	IR	727 208 371	-	2.125	142	135	50	30	14,6	5,8
160	75	IR	727 208 372	-	2.140	142	135	50	30	14,6	6,8
160	90	IR	727 208 373	-	2.160	142	135	50	30	14,6	8,2
160	110	IR	727 208 374	-	2.200	142	135	50	30	14,6	10,0
225	90	IR	727 208 388	-	4.530	155	165	40	30	20,5	8,2
225	110	IR	727 208 389	-	4.520	155	165	40	30	20,5	10,0
225	160	IR	727 208 391	-	4.530	155	165	40	30	20,5	14,6

27 20 83

Tees 90° reduced, PP-H S8,3/SDR17,6**Model:**

- Conventional butt-welding according to DVS 2207 part 1
- IR = Infrared-(IR Plus®) compatible. Please choose fusion parameters: PP-H

* because of fusion reasons the branch is SDR11

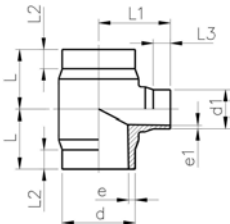

d	d1	FM	Code	SP	kg	L	L1	L2	L3	e	e1
[mm]	[mm]					[mm]	[mm]	[mm]	[mm]	[mm]	[mm]
*63	32	IR	727 208 301	-	0.120	65	70	25	25	3,6	2,9
63	50	IR	727 208 302	-	0.125	65	70	25	25	3,6	2,9
*75	32	IR	727 208 303	-	0.180	70	75	25	25	4,3	2,9
75	50	IR	727 208 304	-	0.180	70	75	25	25	4,3	2,9
75	63	IR	727 208 305	-	0.190	70	75	25	25	4,3	3,6
90	50	IR	727 208 307	-	0.310	80	85	25	25	5,1	2,9
90	63	IR	727 208 308	-	0.310	80	85	25	25	5,1	3,6
90	75	IR	727 208 309	-	0.320	80	85	25	25	5,1	4,3
*110	32	IR	727 208 310	-	0.490	90	95	30	25	6,3	2,9
110	50	IR	727 208 311	-	0.490	90	95	30	25	6,3	2,9
110	63	IR	727 208 312	-	0.500	90	95	30	25	6,3	3,6
110	75	IR	727 208 313	-	0.500	90	95	30	25	6,3	4,3
110	90	IR	727 208 314	-	0.510	90	95	30	25	6,3	5,1
160	63	IR	727 208 321	-	1.560	142	135	50	30	9,1	3,6
160	75	IR	727 208 322	-	1.570	142	135	50	30	9,1	4,3
160	90	IR	727 208 323	-	1.580	142	135	50	30	9,1	5,1
160	110	IR	727 208 324	-	1.600	142	135	50	30	9,1	6,3
225	90	IR	727 208 338	-	3.330	155	165	40	30	12,8	5,1
225	110	IR	727 208 339	-	3.310	155	165	40	30	12,8	6,3
225	160	IR	727 208 341	-	3.330	155	165	40	30	12,8	9,1

Reducers, PP-H S5/SDR11

Model:

- Conventional butt-welding according to DVS 2207 part 1
- IR = Infrared-(IR Plus®) compatible. Please choose fusion parameters: PP-H

¹ PP-R

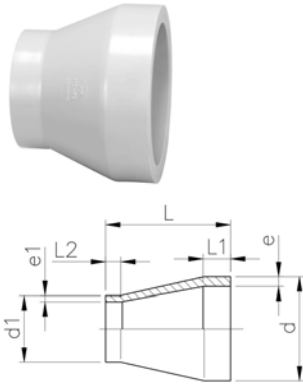

d	d1	FM	Code	SP	kg	L	L1	L2	e	e1
[mm]	[mm]					[mm]	[mm]	[mm]	[mm]	[mm]
25	20	IR	727 908 537	10	0.007	50	20	20	2,3	1,9
32	20	IR	727 908 542	10	0.010	50	20	20	2,9	1,9
32	25	IR	727 908 541	10	0.011	50	20	20	2,9	2,3
40	20	IR	727 908 548	10	0.015	58	20	23	3,7	1,9
40	25	IR	727 908 547	10	0.016	55	20	20	3,7	2,3
40	32	IR	727 908 546	10	0.019	55	20	20	3,7	2,9
50	25	IR	727 908 554	10	0.025	60	20	20	4,6	2,3
50	32	IR	727 908 553	10	0.027	60	20	20	4,6	2,9
50	40	IR	727 908 552	10	0.030	60	20	20	4,6	3,7
63	32	IR	727 908 560	10	0.043	65	20	20	5,8	2,9
63	40	IR	727 908 559	10	0.047	65	20	20	5,8	3,7
63	50	IR	727 908 558	10	0.052	65	20	20	5,8	4,6
75	40	IR	727 908 566	10	0.058	68	20	20	6,8	3,7
75	50	IR	727 908 565	10	0.065	65	20	20	6,8	4,6
75	63	IR	727 908 564	10	0.074	65	20	20	6,8	5,8
90	63	IR	727 908 571	-	0.107	75	22	19	8,2	5,8
90	75	IR	727 908 570	-	0.117	75	22	19	8,2	6,8
110	75	IR	727 908 577	-	0.193	90	28	18	10,0	6,8
110	90	IR	727 908 576	-	0.216	90	28	30	10,0	8,2
125	110	IR	727 908 580	-	0.325	100	32	30	11,4	10,0
140	110	IR	727 908 585	-	0.405	110	33	29	12,7	10,0
140	125	IR	727 908 584	-	0.447	110	34	30	12,7	11,4
160	110	IR	727 908 590	-	0.550	120	39	27	14,6	10,0
160	140	IR	727 908 588	-	0.625	120	40	35	14,6	12,7
180	90	IR	727 908 978	-	0.670	157	45	22	16,4	8,2
180	110	IR	727 908 977	-	0.550	157	45	28	16,4	10,0
180	125	IR	727 908 976	-	0.520	136	45	32	16,4	11,4
180	140	IR	727 908 975	-	0.520	136	45	35	16,4	12,7
180	160	IR	727 908 974	-	0.530	136	45	35	16,4	14,6
200	160	IR	727 908 592	-	1.120	145	50	40	18,2	14,6
200	180	IR	727 908 979	-	0.710	151	50	45	18,2	16,4
225	110	IR	727 908 595	-	1.330	160	55	35	20,5	10,0
225	160	IR	727 908 596	-	1.470	160	55	40	20,5	14,6
225	180	IR	727 908 983	-	0.941	171	55	45	20,5	16,4
225	200	IR	727 908 597	-	1.650	160	55	50	20,5	18,2
250	160	--	727 908 990	-	1.483	194	60	55	22,7	14,6
250	225	--	727 908 987	-	1.041	182	60	55	22,7	20,5
¹ 280	225	--	727 908 992	-	1.804	200	85	80	25,4	20,5
¹ 280	250	--	727 908 991	-	1.311	200	85	90	25,4	22,7
¹ 315	225	--	727 908 997	-	2.615	230	95	85	28,6	20,5
¹ 315	250	--	727 908 996	-	2.204	230	95	95	28,6	22,7
¹ 315	280	--	727 908 995	-	1.590	230	95	107	28,6	25,4
355	250	--	727 908 963	-	4.400	245	90	60	32,3	22,7
355	280	--	727 908 962	-	4.100	245	90	70	32,2	25,4
355	315	--	727 908 961	-	3.700	245	90	80	32,2	28,6
400	315	--	727 908 966	-	5.300	260	95	80	36,3	28,6
400	355	--	727 908 965	-	4.800	260	95	90	36,3	32,2

Reducers, PP-H S8,3/SDR17,6

Model:

- Conventional butt-welding according to DVS 2207 part 1
- IR = Infrared-(IR Plus®) compatible. Please choose fusion parameters: PP-H

¹ PP-R

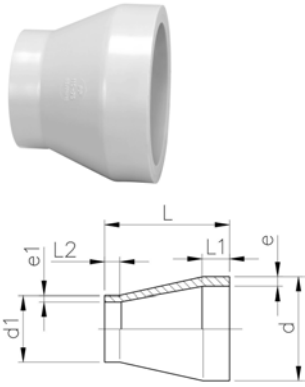

d	d1	FM	Code	SP	kg	L	L1	L2	e	e1
[mm]	[mm]					[mm]	[mm]	[mm]	[mm]	[mm]
50	40	--	727 908 949	-	0.010	55	15	15	2,9	2,3
63	40	--	727 908 901	-	0.020	65	18	15	3,6	2,3
63	50	--	727 908 900	-	0.020	65	18	15	3,6	2,9
75	40	--	727 908 904	-	0.041	71	20	15	4,3	2,3
75	50	--	727 908 903	-	0.042	71	20	15	4,3	2,9
75	63	IR	727 908 902	-	0.039	71	20	18	4,3	3,6
90	63	IR	727 908 906	-	0.074	78	22	18	5,1	3,6
90	75	IR	727 908 905	-	0.062	78	22	20	5,1	4,3
110	75	IR	727 908 909	-	0.108	94	28	20	6,3	4,3
110	90	IR	727 908 908	-	0.097	94	28	22	6,3	5,1
125	110	IR	727 908 912	-	0.151	104	32	28	7,1	6,3
140	110	IR	727 908 917	-	0.144	110	35	28	8,0	6,3
140	125	IR	727 908 916	-	0.150	110	35	32	8,0	7,1
160	110	IR	727 908 922	-	0.287	121	40	28	9,1	6,3
160	140	IR	727 908 920	-	0.245	121	40	35	9,1	8,0
180	90	IR	727 908 928	-	0.440	157	45	22	10,2	5,1
180	110	IR	727 908 927	-	0.360	157	45	28	10,2	6,3
180	125	IR	727 908 926	-	0.340	136	45	32	10,2	7,1
180	140	IR	727 908 925	-	0.340	136	45	35	10,2	8,0
180	160	IR	727 908 924	-	0.350	136	45	40	10,2	9,1
200	160	IR	727 908 930	-	0.461	150	50	40	11,4	9,1
200	180	IR	727 908 929	-	0.600	149	50	45	11,4	10,2
225	110	IR	727 908 936	-	0.960	160	55	35	12,8	6,3
225	160	IR	727 908 934	-	0.620	168	55	40	12,8	9,1
225	180	IR	727 908 933	-	0.600	167	55	45	12,8	10,2
225	200	IR	727 908 932	-	0.614	168	55	50	12,8	11,4
250	160	IR	727 908 940	-	0.975	194	60	45	14,2	9,1
250	225	IR	727 908 937	-	0.681	182	60	55	14,2	12,8
¹ 280	225	--	727 908 942	-	1.180	105	33	23	15,9	12,8
¹ 280	250	--	727 908 941	-	0.858	70	29	21	15,9	14,2
¹ 315	225	--	727 908 947	-	1.715	130	32	24	17,9	12,8
¹ 315	250	--	727 908 946	-	1.446	100	32	24	17,9	14,2
¹ 315	280	--	727 908 945	-	1.040	66	29	19	17,9	15,9
355	250	--	727 908 959	-	3.000	245	90	60	20,1	14,2
355	280	--	727 908 958	-	2.700	245	90	70	20,1	15,9
355	315	--	727 908 957	-	2.400	245	90	80	20,1	17,9
400	315	--	727 908 972	-	3.600	260	95	80	22,7	17,9
400	355	--	727 908 971	-	3.100	260	95	90	22,7	20,1

27 96 89

End Caps, PP-H S5/SDR11**Model:**

- Conventional butt-welding according to DVS 2207 part 1
- IR = Infrared-(IR Plus®) compatible. Please choose fusion parameters: PP-H

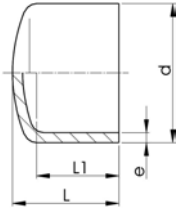
¹ PP-R

d [mm]	FM	Code	SP	kg	L [mm]	L1 [mm]	e [mm]
20	IR	727 968 931	-	0.004	42	30	1,9
25	IR	727 968 932	-	0.005	50	35	2,3
32	IR	727 968 933	-	0.010	55	40	2,9
40	IR	727 968 934	-	0.018	65	45	3,7
50	IR	727 968 935	-	0.029	70	50	4,6
63	IR	727 968 936	-	0.049	80	55	5,8
75	IR	727 968 937	-	0.065	90	60	6,8
90	IR	727 968 938	-	0.107	105	70	8,2
110	IR	727 968 939	-	0.174	120	80	10,0
125	IR	727 968 940	-	0.210	50	25	11,4
140	IR	727 968 941	-	0.323	60	30	12,7
160	IR	727 968 942	-	0.570	76	40	14,6
180	IR	727 968 943	-	1.580	125	88	16,4
200	IR	727 968 944	-	1.060	100	50	18,2
225	IR	727 968 945	-	1.710	103	60	20,5
¹ 250	--	727 968 946	-	2.700	205	130	22,7
¹ 280	--	727 968 947	-	3.100	230	139	25,4
¹ 315	--	727 968 948	-	6.600	255	150	28,6
¹ 355	--	727 968 949	-	9.000	280	165	32,2
¹ 400	--	727 968 950	-	12.500	310	180	36,3

27 96 89

End Caps, PP-H S8,3/SDR17,6**Model:**

- Conventional butt-welding according to DVS 2207 part 1
- IR = Infrared-(IR Plus®) compatible. Please choose fusion parameters: PP-H

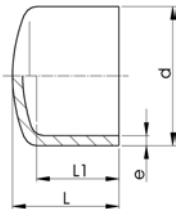
¹ PP-R

d [mm]	FM	Code	SP	kg	L [mm]	L1 [mm]	e [mm]
50	IR	727 968 910	-	0.030	75	53	2,9
63	IR	727 968 911	-	0.050	85	58	3,6
75	IR	727 968 912	-	0.045	90	60	4,3
90	IR	727 968 913	-	0.073	105	70	5,1
110	IR	727 968 914	-	0.118	120	80	6,3
125	IR	727 968 915	-	0.176	50	25	7,1
140	IR	727 968 916	-	0.194	60	30	8,0
160	IR	727 968 917	-	0.408	76	40	9,1
180	IR	727 968 918	-	1.580	125	88	10,2
200	IR	727 968 919	-	0.730	100	50	11,4
225	IR	727 968 920	-	0.965	103	60	12,8
¹ 250		727 968 921	-	2.300	205	130	14,2
¹ 280		727 968 922	-	3.000	230	139	15,9
¹ 315		727 968 923	-	4.500	255	150	17,9
¹ 355		727 968 924	-	6.100	280	165	20,1
¹ 400		727 968 925	-	8.700	310	180	22,7

Flange Adaptors, PP-H S5/SDR11 Joining Face, combination serrated / flat metric

Model:

- Conventional butt-welding according to DVS 2207 part 1
- IR = Infrared-(IR Plus®) compatible. Please choose fusion parameters: PP-H
- Suitable for flange connections to metric (**from d110 also to ANSI B16.5**)
- Do **not** use these flange adaptors when installing butterfly valves. Please use the special flange adaptors provided.

¹ PP-R

d [mm]	DN [mm]	FM	Code	SP	kg	D [mm]	D1 [mm]	L [mm]	L1 [mm]	L2 [mm]	e [mm]	
20	15	IR	727 798 506	10	0.015	26	45	50	7	29	1,9	
25	20	IR	727 798 507	10	0.028	32	58	52	9	27	2,3	
32	25	IR	727 798 508	10	0.042	40	68	54	10	28	2,9	
40	32	IR	727 798 509	10	0.064	49	78	56	11	25	3,7	
50	40	IR	727 798 510	-	0.088	60	88	62	12	32	4,6	
63	50	IR	727 798 511	-	0.144	75	102	68	14	38	5,8	
75	65	IR	727 798 512	-	0.243	89	122	80	16	43	6,8	
90	80	IR	727 798 513	-	0.326	105	138	80	17	41	8,2	
110	100	IR	727 798 514	-	0.441	125	158	80	18	40	10,0	
125	100	IR	727 798 515	-	0.520	132	158	82	25	35	11,4	
140	125	IR	727 798 516	-	0.800	155	188	89	25	39	12,7	
*160	150	IR	727 798 517	-	0.920	175	212	92	25	42	14,6	
180	150	IR	727 798 568	-	0.900	182	212	80	30	50	16,4	
*200	200	IR	727 798 519	-	1.670	232	268	100	32	34	18,2	
*225	200	IR	727 798 520	-	1.700	235	268	100	32	36	20,5	
250	250	--	727 798 571	-	2.790	285	320	100	35	25	22,7	
280	250	--	727 798 572	-	2.610	291	320	100	35	35	25,4	
315	300	--	727 798 573	-	3.410	335	370	100	35	25	28,6	
¹ 355	350	--	727 798 574	-	5.600	373	430	120	40	20	32,2	
¹ 400	400	--	727 798 575	-	8.300	427	482	120	46	29	36,3	

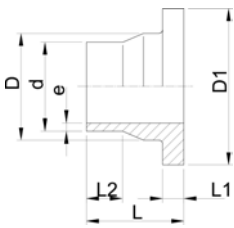

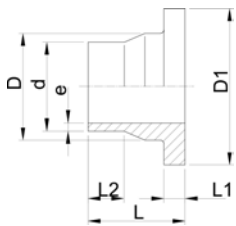
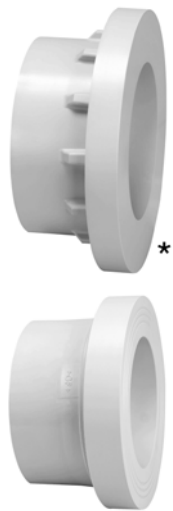

Flange Adaptors, PP-H S8,3/SDR17,6 Jointing Face, combination serrated/ flat metric

Model:

- Conventional butt-welding according to DVS 2207 part 1
- IR = Infrared-(IR Plus®) compatible. Please choose fusion parameters: PP-H
- Suitable for flange connections to metric (**from d110 also to ANSI B16.5**)
- Do **not** use these flange adaptors when installing butterfly valves. Please use the special flange adaptors provided.
- Jointing faces flat/serrated

¹ PP-R

d [mm]	DN [mm]	FM	Code	kg	D [mm]	D1 [mm]	L [mm]	L1 [mm]	L2 [mm]	e [mm]
50	40	--	727 798 535	0.070	61	88	50	12	23	2,9
63	50	IR	727 798 536	0.100	75	102	50	14	18	3,6
125	100	IR	727 798 540	0.335	132	158	80	18	42	7,1
140	125	IR	727 798 541	0.499	155	188	80	18	34	8,0
*160	150	IR	727 798 542	0.640	175	212	92	18	47	9,1
180	150	IR	727 798 543	0.630	180	212	80	20	30	10,2
*200	200	IR	727 798 544	1.500	232	268	100	24	42	11,4
*225	200	IR	727 798 545	1.500	235	268	100	24	47	12,8
250	250	--	727 798 546	1.972	285	320	100	25	35	14,2
280	250	--	727 798 547	1.745	291	320	100	25	45	15,9
315	300	--	727 798 548	2.436	335	370	100	25	35	17,9
*355	350	--	727 798 549	3.900	373	430	120	30	55	20,1
*400	400	--	727 798 550	5.700	427	482	140	33	60	22,7

27 79 86

Flange Adaptors, PP-H S5/SDR11 Jointing face serrated

Model:

- Suitable for flange connections to **ANSI B 16.5**
- Do **not** use these flange adaptors when installing butterfly valves. Please use the special flange adaptors provided.

¹ PP-R

d [mm]	FM	Code	SP	kg	D [mm]	D1 [mm]	L [mm]	L1 [mm]	L2 [mm]	e [mm]
20	IR	727 798 506	10	0.015	26		50	7	29	1,9
25	--	727 798 657	10	0.028	32	54	50	9	24	2,3
32	--	727 798 658	10	0.042	40	63	54	10	27	3,0
40	--	727 798 659	10	0.064	49	73	55	11	24	3,7
50	--	727 798 660	-	0.088	60	82	62	12	30	4,6
63	IR	727 798 511	-	0.144	75		68	14	38	5,8
75	IR	727 798 512	-	0.243	89		80	16	43	6,8
90	IR	727 798 663	-	0.346	105	133	80	17	28	8,2
110	IR	727 798 514	-	0.441	125		80	18	40	10,0
125	IR	727 798 515	-	0.520	132		82	25	35	11,4
140	IR	727 798 516	-	0.800	155		89	25	39	12,7
*160	IR	727 798 517	-	0.920	175		92	25	42	14,6
180	IR	727 798 568	-	0.900	182		80	30	50	16,4
*200	IR	727 798 519	-	1.670	232		100	32	34	18,2
*225	IR	727 798 520	-	1.700	235		100	32	36	20,5
250	--	727 798 571	-	2.790	285		100	35	25	22,7
280	--	727 798 572	-	2.610	291		100	35	35	25,4
315	--	727 798 573	-	3.410	335		100	35	25	28,6
*355	--	727 798 574	-	5.600	373		120	40	20	32,2
*400	--	727 798 575	-	8.300	427		120	46	29	36,3

27 79 88

Special Flange Adaptors, PP-H S5/SDR11 Jointing Face, combination serrated / flat metric

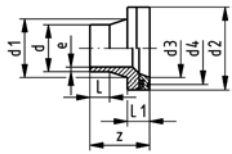
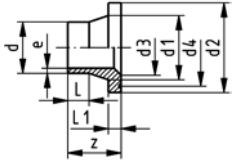

Model:

- Conventional butt-welding according to DVS 2207 part 1
- IR = Infrared-(IR Plus®) compatible. Please choose fusion parameters: PP-H
- Suitable for butterfly valves
- Chamfered and ready for use
- Jointing faces flat/serrated

* Including spacer and O-Ring EPDM

¹ PP-R

d [mm]	DN [mm]	FM	Code	kg	d1 [mm]	d2 [mm]	d3 [mm]	z [mm]	L [mm]	L1 [mm]	e [mm]	d4 [mm]
75	65	IR	727 798 812	0.210	89	122	66	80	43	16	6,8	100
90	80	IR	727 798 813	0.210	105	138	78	80	28	17	8,2	118
110	100	IR	727 798 814	0.440	125	158	100	80	28	18	10,0	140
140	125	IR	727 798 816	0.800	155	188	127	89	37	25	12,7	140
160	150	IR	727 798 817	0.900	175	212	153	92	41	25	14,6	168
180	150	IR	727 798 818	0.920	180	212	154	80	20	30	16,4	175
200	200	IR	727 798 819	1.580	232	268	208	100	34	32	18,2	258
225	200	IR	727 798 820	1.700	235	268	204	100	36	32	20,5	258
²250	250	--	727 798 821	2.450	285	320	254	100	25	35	22,7	280
280	250	--	727 798 822	3.400	291	320	260	100	45	35	25,4	283
³315	300	--	727 798 823	4.400	335	370	309	100	35	35	28,6	330
*355	350	--	727 798 824	7.500	380	430	346	155	40	75	32,2	
*400	400	--	727 798 825	10.300	427	482	404	176	50	82	36,3	

27 79 88

Special Flange Adaptors, PP-H S8,3/SDR17,6 Jointing Face, combination serrated / flat metric

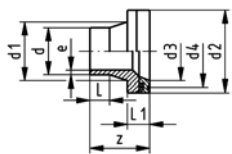
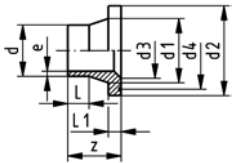
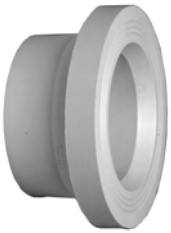

Model:

- Conventional butt-welding according to DVS 2207 part 1
- IR = Infrared-(IR Plus®) compatible. Please choose fusion parameters: PP-H
- Suitable for butterfly valves
- Chamfered and ready for use

* Including spacer and O-Ring EPDM

¹ PP-R

d [mm]	DN [mm]	FM	Code	SP	kg	D [mm]	D1 [mm]	D2 [mm]	L [mm]	L1 [mm]	L2 [mm]	e [mm]
75	65	IR	727 798 412	-	0.202	89	122		80	16	43	4,3
90	80	IR	727 798 413	-	0.274	105	138		80	17	41	5,1
110	100	IR	727 798 414	-	0.358	125	158		80	18	40	6,3
140	125	IR	727 798 541	-	0.499	155	188		80	18	34	8,0
160	150	IR	727 798 842	-	0.770	175	212	153	92	18	41	9,1
200	200	IR	727 798 844	-	1.380	232	268	204	100	24	42	11,4
225	200	IR	727 798 845	-	1.350	235	268	204	100	24	44	12,8
²250	250	--	727 798 846	-	1.800	285	320	254	100	25	25	14,2
280	250	--	727 798 847	-	2.030	291	320	260	100	25	45	15,9
³315	300	--	727 798 848	-	2.200	335	370	309	100	25	35	17,9
*355	350	--	727 798 849	-	5.800	373	430	346	156	66	55	20,1
*400	400	--	727 798 850	-	7.700	427	482	404	176	69	60	22,7

27 80 80

Outlet Flange Adaptors, PP-R S5/SDR11

Model:

- Conventional butt-welding according to DVS 2207 part 1
- To wafer check valves Type 369

Attention:

- In conjunction with outlet flange adaptors, **flange rings for socket systems** must be used.

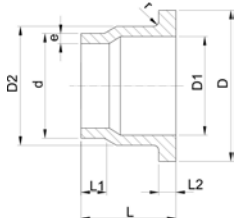

d [mm]	DN [mm]	Code	SP	kg	D [mm]	D1 [mm]	D2 [mm]	L [mm]	L1 [mm]	L2 [mm]	e [mm]	r [mm]
40	32	727 808 034	-	0.064	80	37	50	64	30	11	3,7	3
50	40	727 808 035	-	0.088	90	43	61	67	30	12	4,6	3
63	50	727 808 036	-	0.126	105	54	76	74	30	14	5,8	4
75	65	727 808 037	-	0.187	125	70	90	78	30	16	6,8	4
90	80	727 808 038	-	0.346	140	82	108	87	35	17	8,2	4
110	100	727 808 039	-	0.500	160	105	131	102	41	18	10,0	4
140	125	727 808 041	-	0.710	190	130	165	124	47	25	12,7	4
160	150	727 808 042	-	0.910	215	158	188	149	52	25	14,6	4
225	200	727 808 045	-	1.830	270	206	248	180	55	32	20,5	4
280	250	727 808 047	-	3.550	325	259	308	240	63	35	25,4	4
315	300	727 808 048	-	4.960	375	308	346	272	66	35	28,6	4

27 80 80

Outlet Flange Adaptors, PP-R S8,3/SDR17,6

Model:

- Conventional butt-welding according to DVS 2207 part 1
- To wafer check valves Type 369

Attention:

- In conjunction with outlet flange adaptors, **flange rings for socket systems** must be used.

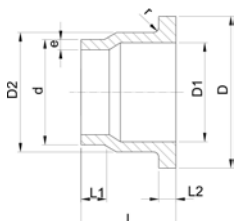

d [mm]	DN [mm]	Code	SP	kg	D [mm]	D1 [mm]	D2 [mm]	L [mm]	L1 [mm]	L2 [mm]	e [mm]	r [mm]
40	32	727 808 009	-	0.048	80	37	50	64	30	11	2,3	3
50	40	727 808 010	-	0.067	90	43	61	67	30	12	2,9	3
63	50	727 808 011	-	0.096	105	54	76	74	30	14	3,6	4
75	65	727 808 012	-	0.170	125	70	90	78	30	16	4,3	4
90	80	727 808 013	-	0.260	140	82	108	87	35	17	5,1	4
110	100	727 808 014	-	0.355	160	105	131	102	41	18	6,3	4
140	125	727 808 016	-	0.500	190	130	165	124	47	18	8,0	4
160	150	727 808 017	-	0.630	215	158	188	149	52	18	9,1	4
225	200	727 808 020	-	1.225	270	206	248	180	55	24	12,7	4
280	250	727 808 022	-	2.230	325	259	308	240	63	25	15,9	4
315	300	727 808 023	-	2.450	375	308	346	272	66	25	17,9	4

Adaptor Fittings for Butt Fusion

Adaptor Sockets, PP-H metric - Rp

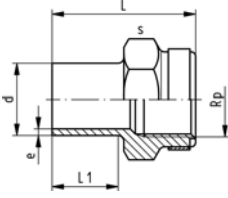

Model:

- With butt fusion spigot **SDR11** and BSP parallel female thread Rp, reinforced
- Connection to plastic or metal
- Reinforcing ring stainless (A2)
- Do not use thread sealing pastes that are harmful to PP
- Install with low mechanical stress and avoid large cyclic temperature changes

d [mm]	Rp [inch]	PN	FM	Code	SP	kg	L [mm]	L1 [mm]	s [mm]	e [mm]
20	½	10	IR	727 910 266	10	0.017	48	23	32	1,9
25	¾	10	IR	727 910 267	10	0.022	50	23	36	2,3
32	1	10	IR	727 910 268	10	0.038	54	23	46	2,9
40	1 ¼	10	IR	727 910 269	10	0.066	56	23	55	3,7
50	1 ½	10	IR	727 910 270	10	0.090	60	23	65	4,6
63	2	10	IR	727 910 271	5	0.140	62	23	80	5,8

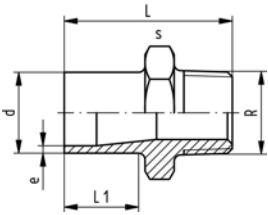

Adaptor Nipples, PP-H metric - R

Model:

- With butt fusion spigot and BSP tapered male thread
- Connection to plastic thread only
- Do not use thread sealing pastes that are harmful to PP
- Install with low mechanical stress and avoid large cyclic temperature changes

d [mm]	R [inch]	PN	FM	Code	SP	kg	L [mm]	L1 [mm]	s [mm]	e [mm]
20	½	10	IR	727 910 556	10	0.013	51	23	32	1,9
25	¾	10	IR	727 910 557	10	0.026	52	23	36	2,3
32	1	10	IR	727 910 558	10	0.028	55	23	46	2,9
40	1 ¼	10	IR	727 910 559	10	0.041	58	23	55	3,7
50	1 ½	10	IR	727 910 560	10	0.062	60	23	65	4,6
63	2	10	IR	727 910 561	5	0.096	67	26	80	5,8

27 91 43

Adaptor Sockets, PP-H metric - NPT

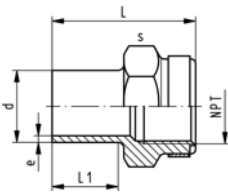

Model:

- With butt fusion spigot **SDR11** and NPT tapered female thread, reinforced
- Connection to plastic or metal
- Reinforcing ring stainless (A2)
- Do not use thread sealing pastes that are harmful to PP
- Install with low mechanical stress and avoid large cyclic temperature changes

d [mm]	NPT [inch]	PN	FM	Code	SP	kg	L [mm]	L1 [mm]	s [mm]	e [mm]
20	½	10	IR	727 914 356	10	0.017	49	23	32	1,9
25	¾	10	IR	727 914 357	10	0.022	51	23	36	2,3
32	1	10	IR	727 914 358	10	0.039	54	23	46	2,9
40	1 ¼	10	IR	727 914 359	10	0.066	56	23	55	3,7
50	1 ½	10	IR	727 914 360	10	0.085	60	23	65	4,6
63	2	10	IR	727 914 361	5	0.122	62	23	80	5,8

27 91 46

Adaptor Nipples, PP-H metric - NPT

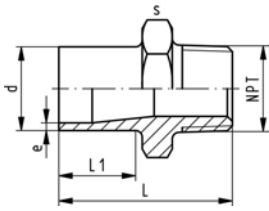

Model:

- With butt fusion spigot **SDR11** and NPT tapered male thread
- Connection to plastic thread only
- Do not use thread sealing pastes that are harmful to PP
- Install with low mechanical stress and avoid large cyclic temperature changes

d [mm]	NPT [inch]	PN	FM	Code	SP	kg	L [mm]	L1 [mm]	s [mm]	e [mm]
20	½	10	IR	727 914 656	10	0.013	51	23	32	1,9
25	¾	10	IR	727 914 657	10	0.026	52	23	36	2,3
32	1	10	IR	727 914 658	10	0.028	55	23	46	2,9
40	1 ¼	10	IR	727 914 659	10	0.041	58	24	55	3,7
50	1 ½	10	IR	727 914 660	10	0.062	60	23	65	4,6
63	2	10	IR	727 914 661	5	0.096	67	26	80	5,8

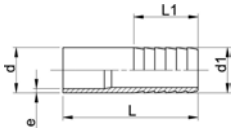

Hose connectors, PP-H metric

Model:

- With butt fusion spigot **SDR11** and parallel hose connection

d [mm]	d1 [mm]	PN	FM	Code	SP	kg	L [mm]	L1 [mm]	e [mm]
20	20	10	IR	727 968 606	10	0.008	64	27	1,9
25	25	10	IR	727 968 607	10	0.012	75	36	2,3
32	32	10	IR	727 968 608	10	0.022	82	36	2,9
40	40	10	IR	727 968 609	10	0.030	84	42	3,7
50	50	10	IR	727 968 610	10	0.060	90	48	4,6
63	60	10	IR	727 968 611	5	0.095	100	50	5,8

Unions for Butt Fusion

EPDM 27 51 85
FPM 27 52 85

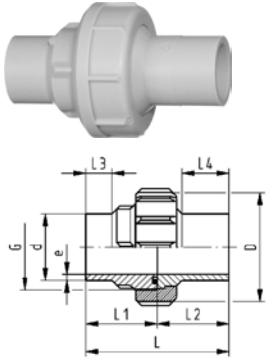

Unions, PP-H S5/SDR11

Model:

- With butt fusion ends
- Conventional butt fusion and (IR Plus®) compatible
- Gasket: O-Ring EPDM No. 48 41 00, FPM No. 49 41 00
- **For the dimensions d75-110 please see instructions for the installation**

d [mm]	PN	FM	EPDM Code	FPM Code	SP	kg
20	10	IR	727 518 506	727 528 506	10	0.046
25	10	IR	727 518 507	727 528 507	10	0.074
32	10	IR	727 518 508	727 528 508	-	0.102
40	10	IR	727 518 509	727 528 509	-	0.169
50	10	IR	727 518 510	727 528 510	5	0.227
63	10	IR	727 518 511	727 528 511	-	0.382
75	10	IR	727 518 512	727 528 512	-	0.560
90	10	IR	727 518 513	727 528 513	-	0.588
110	10	IR	727 518 514	727 528 514	-	0.828

d [mm]	D [mm]	G [inch]	L [mm]	L1 [mm]	L2 [mm]	e [mm]
20	48	1	107	54.0	53.0	1,9
25	58	1 1/4	113	57.0	56.0	2,3
32	65	1 1/2	119	60.0	59.0	2,9
40	79	2	126	63.0	63.0	3,7
50	91	2 1/4	131	65.5	65.5	4,6
63	111	2 3/4	137	69.0	68.0	5,8
75	135	S107,5x3,6	131	66.0	65.5	6,8
90	135	S107,5x3,6	131	65.5	65.5	8,2
110	158	S127,5x3,6	131	65.5	65.5	10,0

EPDM 27 51 84
FPM 27 52 84

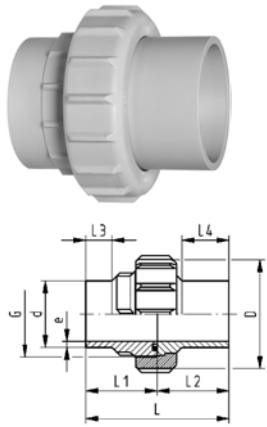

Unions, PP-H S8,3/SDR17,6

Model:

- With butt fusion ends
- Conventional butt fusion and (IR Plus®) compatible
- Gasket: O-Ring EPDM No. 48 41 00, FPM No. 49 41 00
- **For the dimensions d75-110 please see instructions for the installation**

d [mm]	PN	FM	EPDM Code	FPM Code	SP	kg
75	6	IR	727 518 412	727 528 412	-	0.476
90	6	IR	727 518 413	727 528 413	-	0.483
110	6	IR	727 518 414	727 528 414	-	0.663

d [mm]	D [mm]	G [inch]	L [mm]	L1 [mm]	L2 [mm]	e [mm]
75	135	S107,5x3,6	132	66	24	4,3
90	135	S107,5x3,6	131	66	24	5,1
110	158	S127,5x3,6	131	66	25	6,3

27 60 85

Union Ends IR Plus, PP-H SDR11

Model:

- Conventional butt-welding according to DVS 2207 part 1
- IR = Infrared-(IR Plus®) compatible. Please choose fusion parameters: PP-H
- Suitable for unions, diaphragm valves Type 314, tank adaptors and Vortex sensors
- **For the dimensions d75-110 please see instructions for the installation**

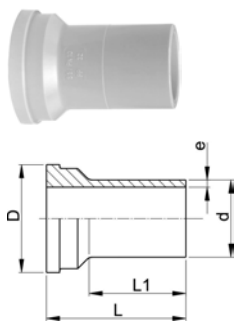

d [mm]	PN	FM	Code	SP	kg	D [mm]	L [mm]	L1 [mm]	e [mm]
20	10	IR	727 608 506	-	0.010	30	54	38	1,9
25	10	IR	727 608 507	-	0.017	39	57	42	2,3
32	10	IR	727 608 508	-	0.024	45	60	41	2,9
40	10	IR	727 608 509	-	0.041	57	63	42	3,7
50	10	IR	727 608 510	-	0.054	63	66	44	4,6
63	10	IR	727 608 511	-	0.092	78	69	45	5,8
75	10	IR	727 608 512	-	0.146	101	66	34	6,8
90	10	IR	727 608 513	-	0.158	101	66	45	8,2
110	10	IR	727 608 514	-	0.233	121	66	40	10,0

27 60 84

Union Ends IR Plus, PP-H SDR17,6

Model:

- Conventional butt-welding according to DVS 2207 part 1
- IR = Infrared-(IR Plus®) compatible. Please choose fusion parameters: PP-H
- Suitable for unions
- **For the dimensions d75-110 please see instructions for the installation**

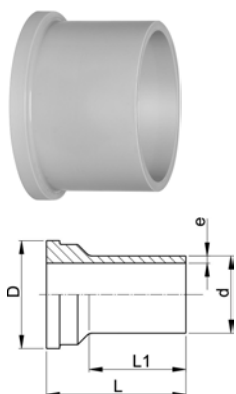

d [mm]	PN	FM	Code	SP	kg	D [mm]	L [mm]	L1 [mm]	e [mm]
75	6	IR	727 608 412	-	0.114	101	66	34	4,3
90	6	IR	727 608 413	-	0.116	101	66	45	5,1
110	6	IR	727 608 414	-	0.165	121	66	40	6,3

27 60 85

Union ends long, PP-H SDR11

Model:

- Conventional butt-welding according to DVS 2207 part 1
- IR = Infrared-(IR Plus®) compatible. Please choose fusion parameters: PP-H
- Spigot for electro fusion
- Suitable for unions, diaphragm valves Type 314 and Vortex sensors

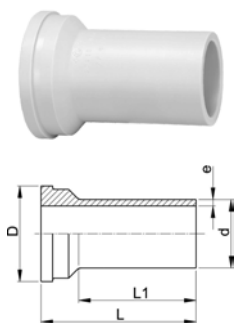

d [mm]	PN	FM	Code	SP	kg	D [mm]	L [mm]	L1 [mm]	e [mm]
20	10	IR	727 608 516	-	0.010	30	67	52	1,9
25	10	IR	727 608 517	-	0.017	39	71	53	2,3
32	10	IR	727 608 518	-	0.024	45	73	55	2,9
40	10	IR	727 608 519	-	0.041	57	81	60	3,7
50	10	IR	727 608 520	-	0.054	63	87	66	4,6
63	10	IR	727 608 521	-	0.092	78	93	70	5,8

Union Bushes, PP-H SDR11

Model:

- Conventional butt-welding according to DVS 2207 part 1
- IR = Infrared-(IR Plus®) compatible. Please choose fusion parameters: PP-H
- Spigot for electro fusion
- Suitable for unions, diaphragm valves Type 314, tank adaptors and Vortex sensors

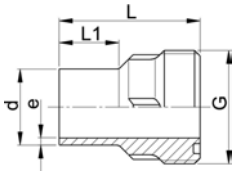

d [mm]	PN	FM	Code	SP	kg	G [inch]	L [mm]	L1 [mm]	e [mm]
20	10	IR	727 648 506	-	0.012	1	54	26	1,9
25	10	IR	727 648 507	-	0.020	1 1/4	57	26	2,3
32	10	IR	727 648 508	-	0.029	1 1/2	60	25	2,9
40	10	IR	727 648 509	-	0.047	2	63	25	3,7
50	10	IR	727 648 510	-	0.064	2 1/4	66	25	4,6
63	10	IR	727 648 511	-	0.104	2 3/4	69	25	5,8
75	10	IR	727 648 512	-	0.172	S107.5x3.6	66	24	6,8
90	10	IR	727 648 513	-	0.182	S107.5x3.6	66	24	8,2
110	10	IR	727 648 514	-	0.258	S127.5x3.6	66	25	10,0

Adaptor Unions

27 53 07

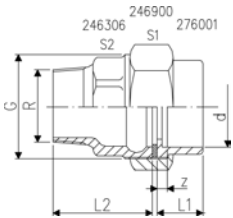

Adaptor Unions Malleable Iron - PP-H

Model:

- Union End: Fusion socket, PP-H metric
- Union Bush: Malleable iron galvanized, BSP tapered male thread
- Union Nut: malleable iron galvanized
- Gasket: flat gasket EPDM No. 48 40 00

d [mm]	R [inch]	PN	Code	SP	kg	G [inch]	L1 [mm]	L2 [mm]	S1 [mm]	S2 [mm]	z [mm]
20	1/2	10	727 530 706	10	0.162	1	19	43	38	25	5
25	3/4	10	727 530 707	5	0.262	1 1/4	21	49	47	31	5
32	1	10	727 530 708	5	0.342	1 1/2	23	53	53	38	5
40	1 1/4	10	727 530 709	2	0.490	2	25	58	66	47	5
50	1 1/2	10	727 530 710	2	0.665	2 1/4	28	62	72	53	5
63	2	10	727 530 711	-	1.041	2 3/4	32	71	89	66	5

27 53 02

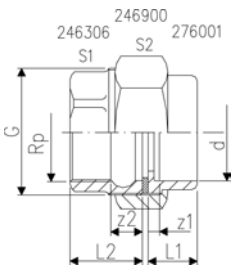

Adaptor Unions Malleable Iron - PP-H

Model:

- Union End: Fusion socket, PP-H metric
- Union Bush: malleable iron galvanized, parallel female thread Rp
- Union Nut: malleable iron galvanized
- Gasket: flat gasket EPDM No. 48 40 00

d [mm]	Rp [inch]	PN	Code	SP	kg	G [inch]	L1 [mm]	L2 [mm]	S1 [mm]	S2 [mm]	z1 [mm]	z2 [mm]
20	1/2	10	727 530 206	10	0.122	1	19	25	38	25	5	12
25	3/4	10	727 530 207	5	0.205	1 1/4	21	28	47	31	5	13
32	1	10	727 530 208	2	0.254	1 1/2	23	31	53	38	5	14
40	1 1/4	10	727 530 209	2	0.421	2	25	33	66	47	5	14
50	1 1/2	10	727 530 210	2	0.551	2 1/4	28	36	72	53	5	17
63	2	10	727 530 211	2	0.842	2 3/4	32	42	89	66	5	18

27 55 07

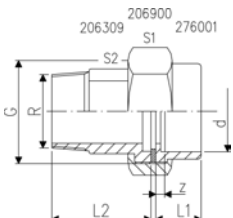

Adaptor Unions Brass - PP-H

Model:

- Union End: Fusion socket, PP-H metric
- Union Bush: Brass, BSP tapered male thread
- Union Nut: brass
- Gasket: flat gasket EPDM No. 48 40 00

d [mm]	R [inch]	PN	Code	SP	kg	G [inch]	L1 [mm]	L2 [mm]	S1 [mm]	S2 [mm]	z [mm]
16	3/8	10	727 550 705	10	0.114	3/4	18	29	30	27	5
20	1/2	10	727 550 706	10	0.139	1	19	32	38	26	5
25	3/4	10	727 550 707	5	0.291	1 1/4	21	49	47	32	5
32	1	10	727 550 708	5	0.349	1 1/2	23	53	52	38	5
40	1 1/4	10	727 550 709	2	0.614	2	25	54	66	60	5
50	1 1/2	10	727 550 710	2	0.746	2 1/4	28	61	72	66	5
63	2	10	727 550 711	-	1.115	2 3/4	32	69	87	83	5

27 55 02

Adaptor Unions Brass - PP-H

Model:

- Union End: Fusion socket, PP-H metric
- Union Bush: Brass, BSP parallel female thread Rp
- Union Nut: brass
- Gasket: flat gasket EPDM No. 48 40 00

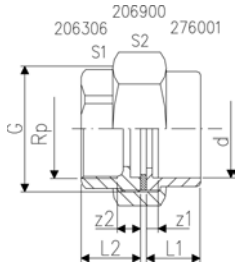

d [mm]	Rp [inch]	PN	Code	SP	kg	G [inch]	L1 [mm]	L2 [mm]	S1 [mm]	S2 [mm]	z1 [mm]	z2 [mm]	
16	3/8	10	727 550 205	10	0.091	3/4	18	17	30	27	5	7	
20	1/2	10	727 550 206	10	0.138	1	19	20	38	27	5	7	
25	3/4	10	727 550 207	5	0.235	1 1/4	21	23	47	32	5	8	
32	1	10	727 550 208	5	0.272	1 1/2	23	26	52	38	5	9	
40	1 1/4	10	727 550 209	2	0.467	2	25	28	66	47	5	9	
50	1 1/2	10	727 550 210	2	0.519	2 1/4	28	29	72	53	5	10	
63	2	10	727 550 211	2	0.816	2 3/4	32	34	87	65	5	10	

Union Ends

27 60 01

Union Ends, PP-H

Model:

- With fusion sockets metric
- Suitable for unions, diaphragm valves Type 314, tank adaptors and Vortex sensors

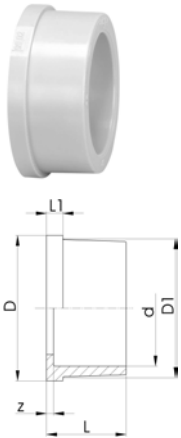

d [mm]	PN	Code	SP	kg	D [mm]	D1 [mm]	L [mm]	L1 [mm]	z [mm]
16	10	727 600 105	-	0.004	24	22	18	4	5
20	10	727 600 106	-	0.006	30	28	19	5	5
25	10	727 600 107	-	0.011	39	36	21	5	5
32	10	727 600 108	-	0.014	45	42	23	6	5
40	10	727 600 109	-	0.025	57	53	25	6	5
50	10	727 600 110	-	0.024	63	59	28	7	5
63	10	727 600 111	-	0.042	79	74	32	8	5
75	10	727 600 112	-	0.085	101	91	36	10	5
90	10	727 600 113	-	0.130	121	108	42	11	7
110	10	727 600 114	-	0.220	146	131	49	12	7

34 60 01

Union Ends, PE80

Model:

- With fusion socket metric
- Suitable for unions, tank connectors and diaphragm valves Type 314

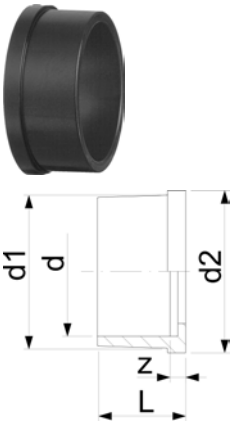

d [mm]	PN	Code	SP	kg	d1 [mm]	d2 [mm]	L [mm]	L1 [mm]	z [mm]
20	6	734 600 106	-	0.006	28	30	19	5	5
25	6	734 600 107	-	0.012	36	39	21	5	5
32	6	734 600 108	-	0.015	42	45	23	6	5
40	6	734 600 109	-	0.026	53	57	25	6	5
50	6	734 600 110	-	0.027	59	63	28	7	5
63	6	734 600 111	-	0.045	74	79	32	8	5

24 60 06

Union Ends, Stainless Steel 1.4404 (316L)**Rp****Model:**

- Parallel female thread Rp

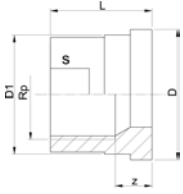

Rp [inch]	PN	Code	SP	kg	z [mm]	D [mm]	D1 [mm]	L [mm]	s [mm]
3/8	16	724 600 655	-	0.030	9	24	22	19	19
1/2	16	724 600 656	-	0.060	11	30	28	24	24
3/4	16	724 600 657	-	0.100	11	39	36	26	29
1	16	724 600 658	-	0.140	12	45	42	29	36
1 1/4	16	724 600 659	-	0.230	14	57	53	33	45
1 1/2	16	724 600 660	-	0.320	15	63	59	34	54
2	16	724 600 661	-	0.450	15	78	74	39	63

24 60 07

Union Ends, Stainless Steel 1.4404 (316L)**R****Model:**

- Taper male thread R

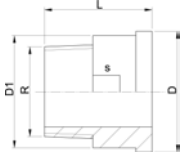

R [inch]	PN	Code	SP	kg	D [mm]	D1 [mm]	L [mm]	s [mm]
3/8	16	724 600 705	-	0.050	24	22	30	19
1/2	16	724 600 706	-	0.090	30	28	34	24
3/4	16	724 600 707	-	0.120	39	36	36	32
1	16	724 600 708	-	0.190	45	42	40	37
1 1/4	16	724 600 709	-	0.350	57	53	46	48
1 1/2	16	724 600 710	-	0.400	63	59	48	54
2	16	724 600 711	-	0.660	78	74	55	69

24 60 55

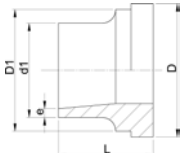
Union Ends, Stainless Steel 1.4404 (316L)**Welding End**

d [mm]	d1 [mm]	PN	Code	SP	kg	D [mm]	D1 [mm]	L [mm]	e [mm]
16	17	16	724 605 505	-	0.030	24	22	18	1.6
20	21	16	724 605 506	-	0.050	30	28	22	2.0
25	26	16	724 605 507	-	0.080	39	36	23	2.0
32	33	16	724 605 508	-	0.110	45	42	26	2.0
40	42	16	724 605 509	-	0.190	57	53	26	2.0
50	48	16	724 605 510	-	0.220	63	59	28	2.0
63	60	16	724 605 511	-	0.370	78	74	32	2.6

Union Bushes

27 64 01

Union Bushes, PP-H

Model:

- With fusion sockets metric
- D75-110 with new thread geometry, now rated PN10 up to d110
- Jointing face: with O-ring groove
- **For the dimensions d75-110 please see instructions for the installation**

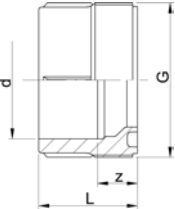

d [mm]	PN	Code	SP	kg	G [inch]	L [mm]	z [mm]
16	10	727 640 155	-	0.006	3/4	24	11
20	10	727 640 156	-	0.011	1	26	12
25	10	727 640 157	-	0.018	1 1/4	28	12
32	10	727 640 158	-	0.024	1 1/2	30	12
40	10	727 640 159	-	0.040	2	34	14
50	10	727 640 160	-	0.052	2 1/4	39	16
63	10	727 640 161	-	0.096	2 3/4	47	20
75	10	727 640 172	-	0.080	S107,5x3,6	51	18
90	10	727 640 173	-	0.220	S127,5x3,6	55	18
110	10	727 640 174	-	0.289	S152,5x3,6	54	22

24 63 06

Union Bushes, Malleable Iron, Galvanized Rp

Model:

- Parallel female thread Rp

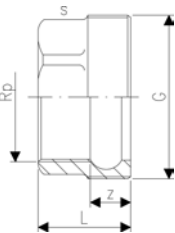

d [mm]	Rp [inch]	PN	Code	kg	z [mm]	L [mm]	G [inch]	s [mm]
32	1	16	724 630 608	0.127	14	31	1 1/2	28
40	1 1/4	16	724 630 609	0.204	14	33	2	47
50	1 1/2	16	724 630 610	0.268	17	36	2 1/4	53
63	2	16	724 630 611	0.550	18	42	2 3/4	66
75	2 1/2	16	724 630 612	0.737	19	46	3 1/2	82
90	3	16	724 630 613	0.913	22	52	4	96

24 63 09

Union Bushes, Malleable Iron, Galvanized R

Model:

- Taper male thread R

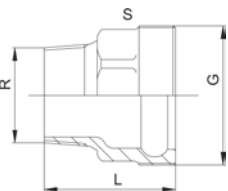

d [mm]	R [inch]	PN	Code	kg	L [mm]	G [inch]	s [mm]
20	1/2	16	724 630 906	0.085	43	1	25
25	3/4	16	724 630 907	0.147	49	1 1/4	31
32	1	16	724 630 908	0.210	53	1 1/2	38
40	1 1/4	16	724 630 909	0.315	58	2	47
50	1 1/2	16	724 630 910	0.411	62	2 1/4	53
63	2	16	724 630 911	0.665	71	2 3/4	66
75	2 1/2	16	724 630 912	0.897	78	3 1/4	82
90	3	16	724 630 913	1.300	87	4	96

20 63 06

Union Bushes, Brass Rp

Model:

- Parallel female thread Rp

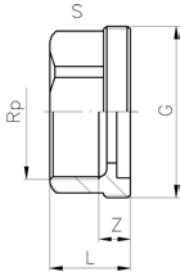

d [mm]	Rp [inch]	PN	Code	kg	z [mm]	L [mm]	G [inch]	s [mm]
16	3/8	16	720 630 605	0.053	7	17	3/4	27
20	1/2	16	720 630 606	0.070	7	20	1	27
25	3/4	16	720 630 607	0.111	8	23	1 1/4	32
32	1	16	720 630 608	0.140	9	26	1 1/2	38
40	1 1/4	16	720 630 609	0.234	9	28	2	47
50	1 1/2	16	720 630 610	0.279	10	29	2 1/4	53
63	2	16	720 630 611	0.437	11	34	2 3/4	65
75	2 1/2	16	720 630 612	0.722	11	38	3 1/2	82
90	3	16	720 630 613	0.954	13	43	4	95

20 63 09

Union Bushes, Brass R

Model:

- Taper male thread R

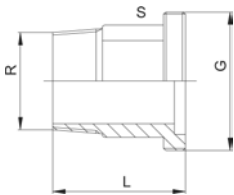

d [mm]	R [inch]	PN	Code	kg	L [mm]	G [inch]	s [mm]
16	3/8	16	720 630 905	0.068	29	3/4	27
20	1/2	16	720 630 906	0.078	32	1	26
25	3/4	16	720 630 907	0.172	49	1 1/4	32
32	1	16	720 630 908	0.223	53	1 1/2	38
40	1 1/4	16	720 630 909	0.376	54	2	60
50	1 1/2	16	720 630 910	0.481	61	2 1/4	66
63	2	16	720 630 911	1.078	69	2 3/4	83
75	2 1/2	16	720 630 912	1.217	76	3 1/2	79
90	3	16	720 630 913	1.525	83	4	80

Union Nuts

27 69 04

Union Nut, PP-GF

Model:

- PP glass-fibre reinforced

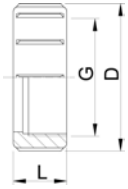

Socket Fusion d [mm]	Butt Fusion d [mm]	PN	G [inch]	Code	SP	kg	D [mm]	L [mm]
16	16	10	3/4	727 690 405	-	0.008	35	21
20	20	10	1	727 690 406	-	0.021	48	24
25	25	10	1 1/4	727 690 407	-	0.034	58	26
32	32	10	1 1/2	727 690 408	-	0.042	65	28
40	40	10	2	727 690 409	-	0.068	79	31
50	50	10	2 1/4	727 690 410	-	0.100	91	35
63	63	10	2 3/4	727 690 411	-	0.168	111	39
75	75-90	10	S107,5x3,6	727 690 422	-	0.205	135	40
90	110	10	S127,5x3,6	727 690 423	-	0.288	158	43
110	-	10	S152,5x3,6	727 690 424	-	0.460	188	48

246900

Union nut, malleable iron, galvanized

Model:

- Malleable iron galvanized

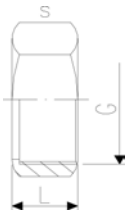

d [mm]	PN	G [inch]	Code	SP	kg	L [mm]	s [mm]
20	16	1	724 690 006	-	0.061	18	39
25	16	1 1/4	724 690 007	-	0.096	20	48
32	16	1 1/2	724 690 008	-	0.125	22	55
40	16	2	724 690 009	-	0.300	24	67
50	16	2 1/4	724 690 010	-	0.245	25	74
63	16	2 3/4	724 690 011	-	0.500	27	90

20 69 00
20 69 04

Union nut, brass

- For tap connector No. 21 55 03 and for adaptor unions brass/PVC

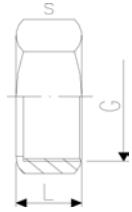

d [mm]	G [inch]	PN	Code	SP	kg	L [mm]	s [mm]
12	1/2	16	720 690 405	-	0.026	16	24
16	3/4	16	720 690 005	-	0.042	17	30
20	1	16	720 690 006	-	0.060	19	38
25	1 1/4	16	720 690 007	-	0.108	20	47
32	1 1/2	16	720 690 008	-	0.105	22	52
40	2	16	720 690 009	-	0.199	25	66
50	2 1/4	16	720 690 010	-	0.268	25	72
63	2 3/4	16	720 690 011	-	0.280	27	87
75	3 1/2	16	720 690 012	-	0.675	34	110
90	4	16	720 690 013	-	0.582	36	120

24 69 01

Union nut stainless steel 1.4404 (316L)

* Octagon union nut

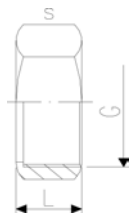

d [mm]	PN	Code	SP	kg	L [mm]	G [inch]	s [mm]
16	16	724 690 105	-	0.060	19	3/4	32
20	16	724 690 106	-	0.110	21	1	41
25	16	724 690 107	-	0.100	23	1 1/4	46
32	16	724 690 108	-	0.170	24	1 1/2	55
*40	16	724 690 109	-	0.240	27	2	68
*50	16	724 690 110	-	0.300	31	2 1/4	74
*63	16	724 690 111	-	0.390	35	2 3/4	88

Ball Valves 546

Ball valve type 546 PP-H With fusion sockets metric

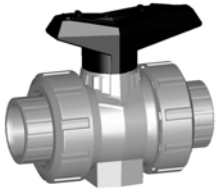

DN10/15 - 50

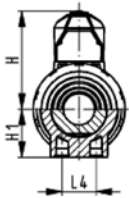
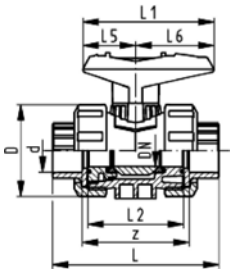

Model:

- Image and drawing DN65-100 please see **New product ball valve DN65-100**
- For easy installation and removal
- z-dimension, valve end and valve nut are **not compatible** with type 346 (DN10/15-50) resp. type 370 (DN65-100)
- Ball seals PTFE
- Without mounting inserts

Option:

- Individual configuration of the valve (see form)
- Multifunctional module with integrated limit switches
- Pneumatic or electric actuators from +GF+

d [mm]	DN [mm]	PN	kv-value ($\Delta p=1$ bar) [l/min]	EPDM Code	FPM Code	kg	
16	10	10	71	167 546 001	167 546 011	0.115	
20	15	10	185	167 546 002	167 546 012	0.115	
25	20	10	350	167 546 003	167 546 013	0.180	
32	25	10	700	167 546 004	167 546 014	0.255	
40	32	10	1000	167 546 005	167 546 015	0.440	
50	40	10	1600	167 546 006	167 546 016	0.610	
63	50	10	3100	167 546 007	167 546 017	1.145	
75	65	10	5000	167 546 008	167 546 018		
90	80	10	7000	167 546 009	167 546 019		
110	100	10	11000	167 546 010	167 546 020		

d [mm]	D [mm]	H [mm]	H1 [mm]	L [mm]	L1 [mm]	L2 [mm]	L4 [mm]	L5 [mm]	L6 [mm]	z [mm]	
16	50	57	27	93	77	56	25	32	45	67	
20	50	57	27	95	77	56	25	32	45	66	
25	58	67	30	109	97	65	25	39	58	77	
32	68	73	36	119	97	71	25	39	58	83	
40	84	90	44	135	128	85	45	54	74	99	
50	97	97	51	147	128	89	45	54	74	105	
63	124	116	64	168	152	101	45	66	87	117	
75	166	149	85	233	270	136	70	64	206	167	
90	200	161	105	254	270	141	70	64	206	180	
110	238	178	123	301	320	164	120	64	256	215	

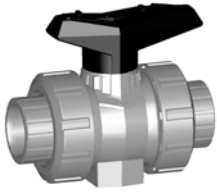

DN10/15 - 50

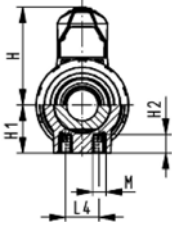
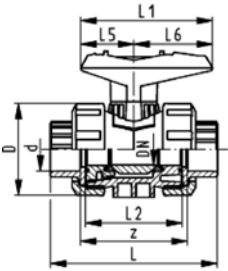

Ball valve type 546 PP-H With mounting inserts With fusion sockets metric

Model:

- Image and drawing DN65-100 please see **New product ball valve DN65-100**
- For easy installation and removal
- z-dimension, valve end and valve nut are **not compatible** with type 346 (DN10/15-50) resp. type 370 (DN65-100)
- Ball seals PTFE
- Integrated stainless steel mounting inserts

Option:

- Individual configuration of the valve (see form)
- Multifunctional module with integrated limit switches
- Pneumatic or electric actuators from +GF+

d [mm]	DN [mm]	PN	kv-value ($\Delta p=1$ bar) [l/min]	EPDM Code	FPM Code	kg
16	10	10	71	167 546 401	167 546 411	0.115
20	15	10	185	167 546 402	167 546 412	0.115
25	20	10	350	167 546 403	167 546 413	0.180
32	25	10	700	167 546 404	167 546 414	0.255
40	32	10	1000	167 546 405	167 546 415	0.440
50	40	10	1600	167 546 406	167 546 416	0.610
63	50	10	3100	167 546 407	167 546 417	1.145
75	65	10	5000	167 546 408	167 546 418	
90	80	10	7000	167 546 409	167 546 419	
110	100	10	11000	167 546 410	167 546 420	

d [mm]	D [mm]	H [mm]	H1 [mm]	H2 [mm]	L [mm]	L1 [mm]	L2 [mm]	L4 [mm]	L5 [mm]	L6 [mm]	M	z [mm]
16	50	57	27	12	93	77	56	25	32	45	M6	67
20	50	57	27	12	95	77	56	25	32	45	M6	66
25	58	67	30	12	109	97	65	25	39	58	M6	77
32	68	73	36	12	119	97	71	25	39	58	M6	83
40	84	90	44	15	135	128	85	45	54	74	M8	99
50	97	97	51	15	147	128	89	45	54	74	M8	105
63	124	116	64	15	168	152	101	45	66	87	M8	117
75	166	149	85	15	233	270	136	70	64	206	M8	167
90	200	161	105	15	254	270	141	70	64	206	M8	180
110	238	178	123	22	301	320	164	120	64	256	M12	215

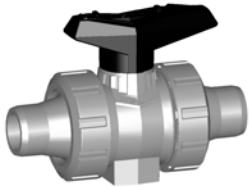

DN10/15 - 50

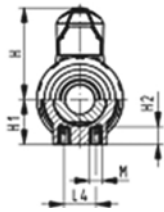
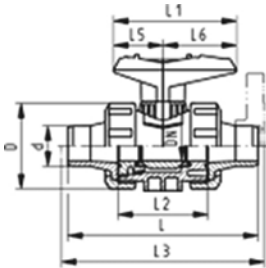



Ball valve type 546 PP-H With mounting inserts With socket fusion spigots metric



Model:

- Image and drawing DN65-100 please see **New product ball valve DN65-100**
- For easy installation and removal
- z-dimension, valve end and valve nut are **not compatible** with type 346 (DN10/15-50) resp. type 370 (DN65-100)
- Ball seals PTFE
- Integrated stainless steel mounting inserts

Option:

- Individual configuration of the valve (see form)
- Multifunctional module with integrated limit switches
- Pneumatic or electric actuators from +GF+

d [mm]	DN [mm]	PN	kv-value ($\Delta p=1$ bar) [l/min]	EPDM Code	FPM Code	kg
16	10	10	71	167 546 041	167 546 051	0.120
20	15	10	185	167 546 042	167 546 052	0.120
25	20	10	350	167 546 043	167 546 053	0.180
32	25	10	700	167 546 044	167 546 054	0.260
40	32	10	1000	167 546 045	167 546 055	0.450
50	40	10	1600	167 546 046	167 546 056	0.640
63	50	10	3100	167 546 047	167 546 057	1.210
 75	65	10	5000	167 546 048	167 546 058	
 90	80	10	7000	167 546 049	167 546 059	
 110	100	10	11000	167 546 050	167 546 060	

d [mm]	D [mm]	H [mm]	H1 [mm]	H2 [mm]	L [mm]	L1 [mm]	L2 [mm]	L3 [mm]	L4 [mm]	L5 [mm]	L6 [mm]	M
16	50	57	27	12	110	77	56		25	32	45	M6
20	50	57	27	12	120	77	56	130	25	32	45	M6
25	58	67	30	12	139	97	65	150	25	39	58	M6
32	68	73	36	12	150	97	71	160	25	39	58	M6
40	84	90	44	15	170	128	85	180	45	54	74	M8
50	97	97	51	15	190	128	89	200	45	54	74	M8
63	124	116	64	15	220	152	101	230	45	66	87	M8
 75	166	149	85	15	280	270	136	290	70	64	206	M8
 90	200	161	105	15	296	270	141	310	70	64	206	M8
 110	238	178	123	22	336	320	164	350	120	64	256	M12

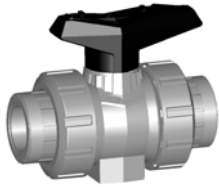

DN10/15 - 50

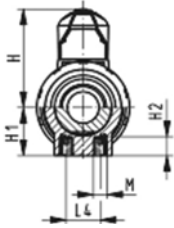
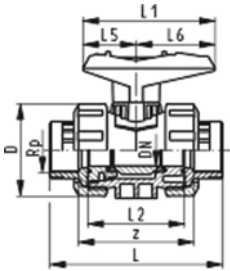

Ball valve type 546 PP-H With mounting inserts With threaded sockets Rp

Model:

- Image and drawing DN65-100 please see **New product ball valve DN65-100**
- For easy installation and removal
- z-dimension, valve end and valve nut are **not compatible** with type 346 (DN10/15-50) resp. type 370 (DN65-100)
- Ball seals PTFE
- Integrated stainless steel mounting inserts

Option:

- Individual configuration of the valve (see form)
- Multifunctional module with integrated limit switches
- Pneumatic or electric actuators from +GF+

Rp [inch]	DN [mm]	PN	kv-value ($\Delta p=1$ bar) [l/min]	EPDM Code	FPM Code	kg	
3/8	10	10	71	167 546 021	167 546 031	0.120	
1/2	15	10	185	167 546 022	167 546 032	0.120	
3/4	20	10	350	167 546 023	167 546 033	0.180	
1	25	10	700	167 546 024	167 546 034	0.270	
1 1/4	32	10	1000	167 546 025	167 546 035	0.460	
1 1/2	40	10	1600	167 546 026	167 546 036	0.635	
2	50	10	3100	167 546 027	167 546 037	1.190	

Rp [inch]	D [mm]	H [mm]	H1 [mm]	H2 [mm]	L [mm]	L1 [mm]	L2 [mm]	L4 [mm]	L5 [mm]	L6 [mm]	M	z [mm]	
3/8	50	57	27	12	96	77	56	25	32	45	M6	69	
1/2	50	57	27	12	99	77	56	25	32	45	M6	67	
3/4	58	67	30	12	111	97	65	25	39	58	M6	78	
1	68	73	36	12	127	97	71	25	39	58	M6	85	
1 1/4	84	90	44	15	146	128	85	45	54	74	M8	100	
1 1/2	97	97	51	15	157	128	89	45	54	74	M8	106	
2	124	116	64	15	183	152	101	45	66	87	M8	121	

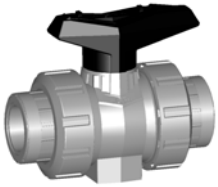

DN10/15 - 50

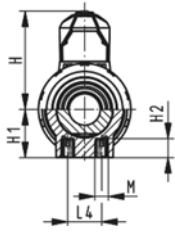
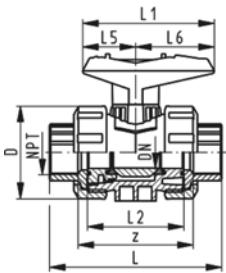

Ball valve type 546 PP-H With mounting inserts With threaded sockets NPT

Model:

- Image and drawing DN65-100 please see **New product ball valve DN65-100**
- For easy installation and removal
- z-dimension, valve end and valve nut are **not compatible** with type 346 (DN10/15-50) resp. type 370 (DN65-100)
- Ball seals PTFE
- Integrated stainless steel mounting inserts

Option:

- Individual configuration of the valve (see form)
- Multifunctional module with integrated limit switches
- Pneumatic or electric actuators from +GF+

NPT [inch]	DN [mm]	PN	kv-value ($\Delta p=1$ bar) [l/min]	EPDM Code	FPM Code	kg	
3/8	10	10	71	167 546 321	167 546 331	0.120	
1/2	15	10	185	167 546 322	167 546 332	0.120	
3/4	20	10	350	167 546 323	167 546 333	0.180	
1	25	10	700	167 546 324	167 546 334	0.270	
1 1/4	32	10	1000	167 546 325	167 546 335	0.460	
1 1/2	40	10	1600	167 546 326	167 546 336	0.635	
2	50	10	3100	167 546 327	167 546 337	1.190	

NPT [inch]	D [mm]	H [mm]	H1 [mm]	H2 [mm]	L [mm]	L1 [mm]	L2 [mm]	L4 [mm]	L5 [mm]	L6 [mm]	M	z [mm]	
3/8	50	57	27	12	96	77	56	25	32	45	M6	71	
1/2	50	57	27	12	99	77	56	25	32	45	M6	64	
3/4	58	67	30	12	111	97	65	25	39	58	M6	76	
1	68	73	36	12	127	97	71	25	39	58	M6	83	
1 1/4	84	90	44	15	146	128	85	45	54	74	M8	100	
1 1/2	97	97	51	15	157	128	89	45	54	74	M8	111	
2	124	116	64	15	183	152	101	45	66	87	M8	134	

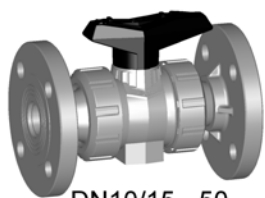

DN10/15 - 50

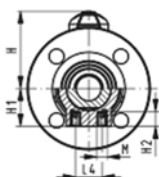
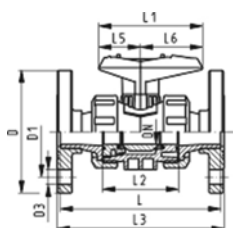

Ball valve type 546 PP-H With mounting inserts With fixed flanges PP-H serrated metric

Model:

- Image and drawing DN65-100 please see **New product ball valve DN65-100**
- For easy installation and removal
- z-dimension, valve end and valve nut are **not compatible** with type 346 (DN10/15-50) resp. type 370 (DN65-100)
- Ball seals PTFE
- Integrated stainless steel mounting inserts
- Overall length EN 558-1
- Connecting dimensions: ISO 7005 / EN 1092 / DIN 2501 PN10 / BS4504

Option:

- Individual configuration of the valve (see form)
- Multifunctional module with integrated limit switches
- Pneumatic or electric actuators from +GF+

d [mm]	DN [mm]	Inch	PN	kv-value ($\Delta p=1$ bar) [l/min]	EPDM Code	FPM Code	kg
20	15	1/2	10	185	167 546 182	167 546 192	0.245
25	20	3/4	10	350	167 546 183	167 546 193	0.345
32	25	1	10	700	167 546 184	167 546 194	0.495
40	32	1 1/4	10	1000	167 546 185	167 546 195	0.830
50	40	1 1/2	10	1600	167 546 186	167 546 196	1.100
63	50	2	10	3100	167 546 187	167 546 197	1.830

d [mm]	D [mm]	D1 [mm]	D3 [mm]	H [mm]	H1 [mm]	H2 [mm]	L [mm]	L1 [mm]	L2 [mm]	L3 [mm]	L4 [mm]	L5 [mm]	L6 [mm]	M
20	95	65	14	57	27	12	120	77	56	130	25	32	45	M6
25	105	75	14	67	30	12	140	97	65	150	25	39	58	M6
32	115	85	14	73	36	12	150	97	71	160	25	39	58	M6
40	140	100	18	90	44	15	170	128	85	180	45	54	74	M8
50	150	110	18	97	51	15	190	128	89	200	45	54	74	M8
63	165	125	18	116	64	15	220	152	101	230	45	66	87	M8

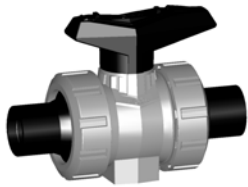

DN10/15 - 50

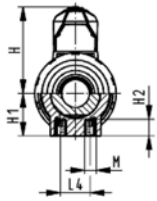
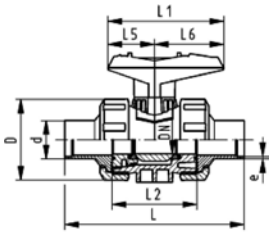

Ball valve type 546 PP-H With mounting inserts With butt fusion spigots PE 100 SDR11 metric

Model:

- Image and drawing DN65-100 please see **New product ball valve DN65-100**
- For easy installation and removal
- z-dimension, valve end and valve nut are **not compatible** with type 346 (DN10/15-50) resp. type 370 (DN65-100)
- Ball seals PTFE
- Integrated stainless steel mounting inserts

Option:

- Individual configuration of the valve (see form)
- Multifunctional module with integrated limit switches
- Pneumatic or electric actuators from +GF+

d [mm]	DN [mm]	PN	kv-value ($\Delta p=1$ bar) [l/min]	EPDM Code	FPM Code	kg	
20	15	10	185	167 546 142	167 546 152	0.120	
25	20	10	350	167 546 143	167 546 153	0.180	
32	25	10	700	167 546 144	167 546 154	0.255	
40	32	10	1000	167 546 145	167 546 155	0.440	
50	40	10	1600	167 546 146	167 546 156	0.620	
63	50	10	3100	167 546 147	167 546 157	1.200	

d [mm]	D [mm]	H [mm]	H1 [mm]	H2 [mm]	L [mm]	L1 [mm]	L2 [mm]	L3 [mm]	L4 [mm]	L5 [mm]	L6 [mm]	M	e [mm]	
20	50	57	27	12	130	77	56	130	25	32	45	M6	1,9	
25	58	67	30	12	143	97	65	150	25	39	58	M6	2,3	
32	68	73	36	12	150	97	71	160	25	39	58	M6	3	
40	84	90	44	15	171	128	85	180	45	54	74	M8	3,7	
50	97	97	51	15	191	128	89	200	45	54	74	M8	4,6	
63	124	116	64	15	220	152	101	230	45	66	87	M8	5,8	

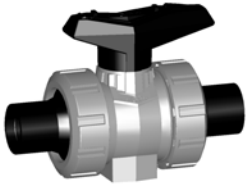

DN10/15 - 50

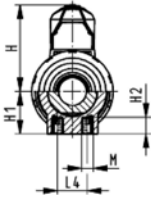
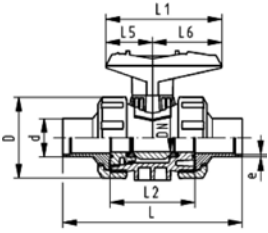

Ball valve type 546 PP-H With mounting inserts With butt fusion spigots PE 100 SDR17.6 metric

Model:

- Image and drawing DN65-100 please see **New product ball valve DN65-100**
- For easy installation and removal
- z-dimension, valve end and valve nut are **not compatible** with type 346 (DN10/15-50) resp. type 370 (DN65-100)
- Ball seals PTFE
- Integrated stainless steel mounting inserts

Option:

- Individual configuration of the valve (see form)
- Multifunctional module with integrated limit switches
- Pneumatic or electric actuators from +GF+

d [mm]	DN [mm]	PN	kv-value ($\Delta p=1$ bar) [l/min]	EPDM Code	FPM Code	kg								
50	40	6	1600	167 546 126	167 546 136	0.620								
63	50	6	3100	167 546 127	167 546 137	1.200								
d [mm]	D [mm]	H [mm]	H1 [mm]	H2 [mm]	L [mm]	L1 [mm]	L2 [mm]	L4 [mm]	L5 [mm]	L6 [mm]	M	e [mm]		
50	97	97	51	15	191	128	89	45	54	74	M8	2,9		
63	124	116	64	15	220	152	101	45	66	87	M8	3,6		

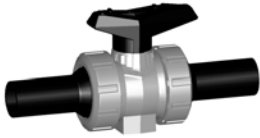

DN10/15 - 50

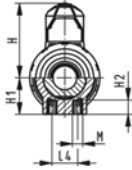
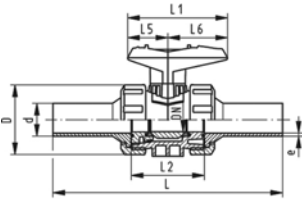

Ball valve type 546 PP-H With mounting inserts With butt fusion spigots long PE 100 SDR11 metric

Model:

- Image and drawing DN65-100 please see **New product ball valve DN65-100**
- For easy installation and removal
- z-dimension, valve end and valve nut are **not compatible** with type 346 (DN10/15-50) resp. type 370 (DN65-100)
- Ball seals PTFE
- Integrated stainless steel mounting inserts

Option:

- Individual configuration of the valve (see form)
- Multifunctional module with integrated limit switches
- Pneumatic or electric actuators from +GF+

d [mm]	DN [mm]	PN	kv-value ($\Delta p=1$ bar) [l/min]	EPDM Code	FPM Code	kg
20	15	10	185	167 546 282	167 546 292	0.130
25	20	10	350	167 546 283	167 546 293	0.195
32	25	10	700	167 546 284	167 546 294	0.280
40	32	10	1000	167 546 285	167 546 295	0.485
50	40	10	1600	167 546 286	167 546 296	0.695
63	50	10	3100	167 546 287	167 546 297	1.320
75	65	10	5000	167 546 288	167 546 298	
90	80	10	7000	167 546 289	167 546 299	
110	100	10	11000	167 546 290	167 546 300	

d [mm]	D [mm]	H [mm]	H1 [mm]	H2 [mm]	L [mm]	L1 [mm]	L2 [mm]	L4 [mm]	L5 [mm]	L6 [mm]	M	e [mm]
20	50	57	27	12	193	77	56	25	32	45	M6	2,3
25	58	67	30	12	216	97	65	25	39	58	M6	2,3
32	68	73	36	12	223	97	71	25	39	58	M6	3
40	84	90	44	15	249	128	85	45	54	74	M8	3,7
50	97	97	51	15	271	128	89	45	54	74	M8	4,6
63	124	116	64	15	321	152	101	45	66	87	M8	5,8
75	166	149	85	15	386	270	136	70	64	206	M8	6.8
90	200	161	105	15	421	270	141	70	64	206	M8	8.2
110	238	178	123	22	484	320	164	120	64	256	M12	10

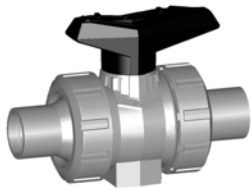

DN10/15 - 50

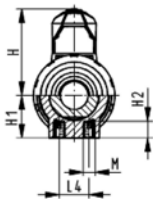
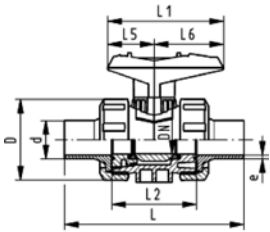



Ball valve type 546 PP-H With mounting inserts With butt fusion spigots IR-Plus SDR11 metric



Model:

- Image and drawing DN65-100 please see **New product ball valve DN65-100**
- For easy installation and removal
- z-dimension, valve end and valve nut are **not compatible** with type 346 (DN10/15-50) resp. type 370 (DN65-100)
- Ball seals PTFE
- Integrated stainless steel mounting inserts

Option:

- Individual configuration of the valve (see form)
- Multifunctional module with integrated limit switches
- Pneumatic or electric actuators from +GF+

d [mm]	DN [mm]	PN	kv-value ($\Delta p=1$ bar) [l/min]	EPDM Code	FPM Code	kg
20	15	10	185	167 546 442	167 546 452	0.120
25	20	10	350	167 546 443	167 546 453	0.180
32	25	10	700	167 546 444	167 546 454	0.255
40	32	10	1000	167 546 445	167 546 455	0.440
50	40	10	1600	167 546 446	167 546 456	0.620
63	50	10	3100	167 546 447	167 546 457	1.200
 75	65	10	5000	167 546 448	167 546 458	
 90	80	10	7000	167 546 449	167 546 459	
 110	100	10	11000	167 546 450	167 546 460	

d [mm]	D [mm]	H [mm]	H1 [mm]	H2 [mm]	L [mm]	L1 [mm]	L2 [mm]	L4 [mm]	L5 [mm]	L6 [mm]	M	e [mm]
20	50	57	27	12	130	77	56	25	32	45	M6	1,9
25	58	67	30	12	143	97	65	25	39	58	M6	2,3
32	68	73	36	12	150	97	71	25	39	58	M6	3
40	84	90	44	15	171	128	85	45	54	74	M8	3,7
50	97	97	51	15	191	128	89	45	54	74	M8	4,6
63	124	116	64	15	220	152	101	45	66	87	M8	5,8
 75	166	149	85	15	266	270	136	70	64	206	M8	8.2
 90	200	161	105	15	264	270	141	70	64	206	M8	9.9
 110	238	178	123	22	301	320	164	120	64	256	M12	12

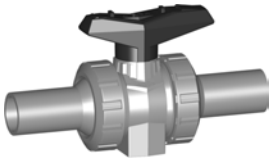

DN10/15 - 50

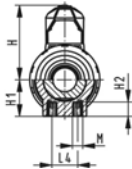
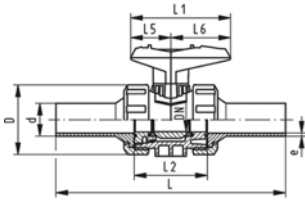

Ball valve type 546 PP-H With mounting inserts With butt fusion spigots long SDR11 metric

Model:

- Image and drawing DN65-100 please see **New product ball valve DN65-100**
- For easy installation and removal
- z-dimension, valve end and valve nut are **not compatible** with type 346 (DN10/15-50) resp. type 370 (DN65-100)
- Ball seals PTFE
- Integrated stainless steel mounting inserts

Option:

- Individual configuration of the valve (see form)
- Multifunctional module with integrated limit switches
- Pneumatic or electric actuators from +GF+

d [mm]	DN [mm]	PN	kv-value ($\Delta p=1$ bar) [l/min]	EPDM Code	FPM Code	kg	
20	15	10	185	167 546 262	167 546 272	0.130	
25	20	10	350	167 546 263	167 546 273	0.195	
32	25	10	700	167 546 264	167 546 274	0.280	
40	32	10	1000	167 546 265	167 546 275	0.480	
50	40	10	1600	167 546 266	167 546 276	0.700	
63	50	10	3100	167 546 267	167 546 277	1.320	

d [mm]	D [mm]	H [mm]	H1 [mm]	H2 [mm]	L [mm]	L1 [mm]	L2 [mm]	L4 [mm]	L5 [mm]	L6 [mm]	M	e [mm]	
20	50	57	27	12	193	77	56	25	32	45	M6	2,3	
25	58	67	30	12	216	97	65	25	39	58	M6	2,3	
32	68	73	36	12	223	97	71	25	39	58	M6	3	
40	84	90	44	15	249	128	85	45	54	74	M8	3,7	
50	97	97	51	15	271	128	89	45	54	74	M8	4,6	
63	124	116	64	15	321	152	101	45	66	87	M8	5,8	

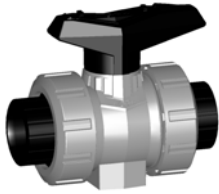

DN10/15 - 50

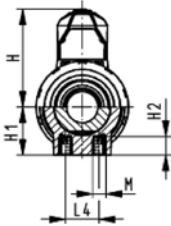
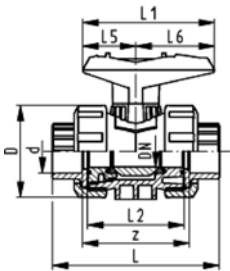

Ball valve type 546 PP-H With mounting inserts With fusion sockets PE 100 metric

Model:

- Image and drawing DN65-100 please see **New product ball valve DN65-100**
- For easy installation and removal
- z-dimension, valve end and valve nut are **not compatible** with type 346 (DN10/15-50) resp. type 370 (DN65-100)
- Ball seals PTFE
- Integrated stainless steel mounting inserts

Option:

- Individual configuration of the valve (see form)
- Multifunctional module with integrated limit switches
- Pneumatic or electric actuators from +GF+

d [mm]	DN [mm]	PN	kv-value ($\Delta p=1$ bar) [l/min]	EPDM Code	FPM Code	kg	
16	10	10	71	167 546 161	167 546 171	0.120	
20	15	10	185	167 546 162	167 546 172	0.120	
25	20	10	350	167 546 163	167 546 173	0.180	
32	25	10	700	167 546 164	167 546 174	0.260	
40	32	10	1000	167 546 165	167 546 175	0.450	
50	40	10	1600	167 546 166	167 546 176	0.630	
63	50	10	3100	167 546 167	167 546 177	1.195	

d [mm]	D [mm]	H [mm]	H1 [mm]	H2 [mm]	L [mm]	L1 [mm]	L2 [mm]	L4 [mm]	L5 [mm]	L6 [mm]	M	z [mm]	
16	50	57	27	12	93	77	56	25	32	45	M6	67	
20	50	57	27	12	95	77	56	25	32	45	M6	67	
25	58	67	30	12	109	97	65	25	39	58	M6	77	
32	68	73	36	12	119	97	71	25	39	58	M6	83	
40	84	90	44	15	135	128	85	45	54	74	M8	99	
50	97	97	51	15	147	128	89	45	54	74	M8	105	
63	124	116	64	15	168	152	101	45	66	87	M8	113	

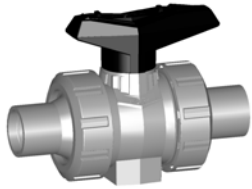

DN10/15 - 50

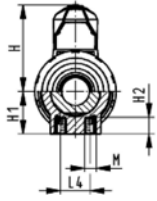
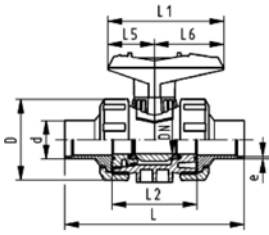

Ball valve type 546 PP-H With mounting inserts With butt fusion spigots SDR17.6 metric

Model:

- Image and drawing DN65-100 please see **New product ball valve DN65-100**
- For easy installation and removal
- z-dimension, valve end and valve nut are **not compatible** with type 346 (DN10/15-50) resp. type 370 (DN65-100)
- Ball seals PTFE
- Integrated stainless steel mounting inserts

Option:

- Individual configuration of the valve (see form)
- Multifunctional module with integrated limit switches
- Pneumatic or electric actuators from +GF+

d [mm]	DN [mm]	PN	kv-value ($\Delta p=1$ bar) [l/min]	EPDM Code	FPM Code	kg
50	40	6	1600	167 546 066	167 546 076	0.635
63	50	6	3100	167 546 067	167 546 077	1.200
75	65	6	5000	167 546 068	167 546 078	
90	80	6	7000	167 546 069	167 546 079	
110	100	6	11000	167 546 070	167 546 080	

d [mm]	D [mm]	H [mm]	H1 [mm]	H2 [mm]	L [mm]	L1 [mm]	L2 [mm]	L4 [mm]	L5 [mm]	L6 [mm]	M	e [mm]
50	97	97	51	15	191	128	89	45	54	74	M8	2,9
63	124	116	64	15	220	152	101	45	66	87	M8	3,6
75	166	149	85	15	266	270	136	70	64	206	M8	4.7
90	200	161	105	15	264	270	141	70	64	206	M8	5.5
110	238	178	123	22	301	320	164	120	64	256	M12	6.8

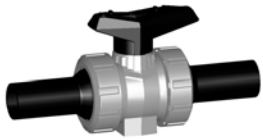

DN10/15 - 50

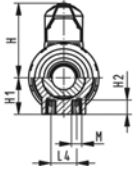
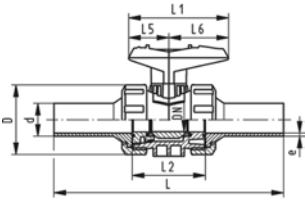

Ball valve type 546 PP-H With mounting inserts With butt fusion spigots long PE 100 SDR17,6 metric

Model:

- Image and drawing DN65-100 please see **New product ball valve DN65-100**
- For easy installation and removal
- z-dimension, valve end and valve nut are **not compatible** with type 346 (DN10/15-50) resp. type 370 (DN65-100)
- Ball seals PTFE
- Integrated stainless steel mounting inserts

Option:

- Individual configuration of the valve (see form)
- Multifunctional module with integrated limit switches
- Pneumatic or electric actuators from +GF+

d [mm]	DN [mm]	PN	kv-value ($\Delta p=1$ bar) [l/min]	EPDM Code	FPM Code
75	65	10	5000	167 546 308	167 546 318
90	80	10	7000	167 546 309	167 546 319
110	100	10	11000	167 546 310	167 546 320

d [mm]	D [mm]	H [mm]	H1 [mm]	H2 [mm]	L [mm]	L1 [mm]	L2 [mm]	L4 [mm]	L5 [mm]	L6 [mm]	M	e [mm]
75	166	149	85	15	386	270	136	70	64	206	8	4.3
90	200	161	105	15	421	270	141	70	64	206	8	5.1
110	238	178	123	22	484	320	164	120	64	256	12	6.3

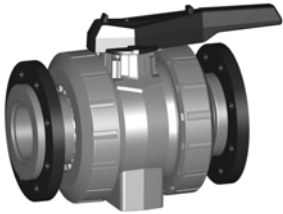

Ball valve type 546 PP-H With mounting inserts With backing flanges PP-st metric

Model:

- Image and drawing DN65-100 please see **New product ball valve DN65-100**
- For easy installation and removal
- z-dimension, valve end and valve nut are **not compatible** with type 346 (DN10/15-50) resp. type 370 (DN65-100)
- Ball seals PTFE
- Integrated stainless steel mounting inserts
- Overall length according to EN 558-1
- Connecting dimensions: ISO 7005, EN 1092, BS 4504, DIN 2501; bolt circle PN 10

Option:

- Individual configuration of the valve (see form)
- Multifunctional module with integrated limit switches
- Pneumatic or electric actuators from +GF+

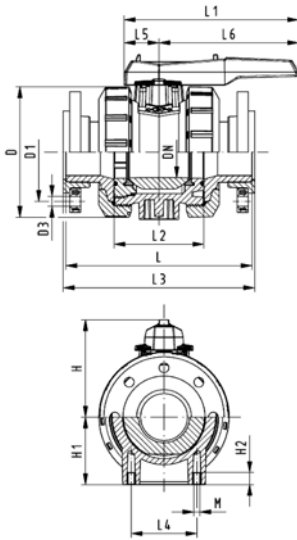

d [mm]	DN [mm]	PN	kv-value ($\Delta p=1$ bar) [l/min]	EPDM Code	FPM Code
75	65	10	5000	167 546 808	167 546 818
90	80	10	7000	167 546 809	167 546 819
110	100	10	11000	167 546 810	167 546 820

d [mm]	D [mm]	D1 [mm]	D3 [mm]	L [mm]	L1 [mm]	L2 [mm]	L3 [mm]	L4 [mm]	L5 [mm]	L6 [mm]	H [mm]	H1 [mm]	M
75	166	145	18	280	270	136	290	70	64	206	149	85	8
90	200	160	18	296	270	141	310	70	64	206	161	105	8
110	238	180	18	336	320	164	350	120	64	256	178	123	12

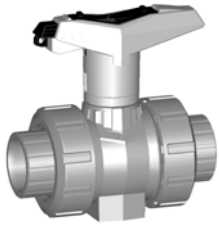

DN10/15 - 50

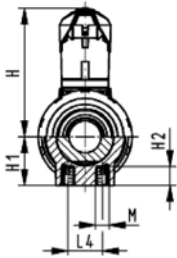
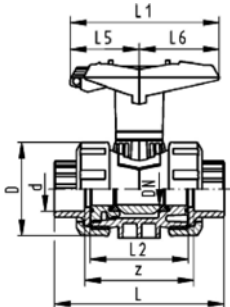

Ball valve type 546 PP-H With lockable handle With fusion sockets metric

Model:

- Image and drawing DN65-100 please see **New product ball valve DN65-100**
- For easy installation and removal
- z-dimension, valve end and valve nut are **not compatible** with type 346 (DN10/15-50) resp. type 370 (DN65-100)
- Ball seals PTFE
- Integrated stainless steel mounting inserts
- Lockable hand lever with ratchet settings

Option:

- Individual configuration of the valve (see form)
- Multifunctional module with integrated limit switches
- Pneumatic or electric actuators from +GF+

d [mm]	DN [mm]	PN	kv-value ($\Delta p=1$ bar) [l/min]	EPDM Code	FPM Code	kg
16	10	10	71	167 546 421	167 546 431	0.125
20	15	10	185	167 546 422	167 546 432	0.125
25	20	10	350	167 546 423	167 546 433	0.195
32	25	10	700	167 546 424	167 546 434	0.270
40	32	10	1000	167 546 425	167 546 435	0.465
50	40	10	1600	167 546 426	167 546 436	0.635
63	50	10	3100	167 546 427	167 546 437	1.175
75	65	10	5000	167 546 428	167 546 438	
90	80	10	7000	167 546 429	167 546 439	
110	100	10	11000	167 546 430	167 546 440	

d [mm]	D [mm]	H [mm]	H1 [mm]	H2 [mm]	L [mm]	L1 [mm]	L2 [mm]	L4 [mm]	L5 [mm]	L6 [mm]	M	z [mm]
16	50	79	27	12	93	77	56	25	32	45	M6	67
20	50	79	27	12	95	77	56	25	32	45	M6	66
25	58	88	30	12	109	97	65	25	39	58	M6	77
32	68	94	36	12	119	97	71	25	39	58	M6	83
40	84	113	44	15	135	128	85	45	54	74	M8	99
50	97	119	51	15	147	128	89	45	54	74	M8	105
63	124	141	64	15	168	152	101	45	66	87	M8	117
75	166	224	85	15	233	270	136	70	64	206	M8	167
90	200	235	105	15	254	270	141	70	64	206	M8	180
110	238	245	123	22	301	320	164	120	64	256	M12	215

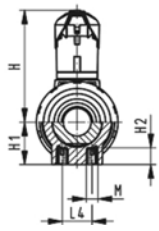
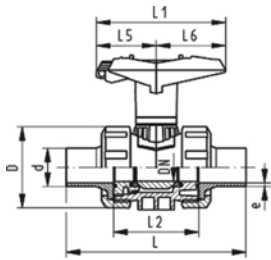
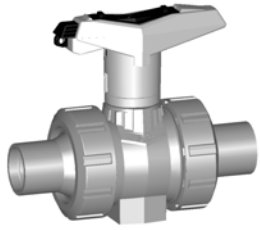



Ball valve type 546 PP-H With lockable handle With butt fusion spigots IR-Plus SDR11 metric



Model:

- Image and drawing DN65-100 please see **New product ball valve DN65-100**
- For easy installation and removal
- z-dimension, valve end and valve nut are **not compatible** with type 346 (DN10/15-50) resp. type 370 (DN65-100)
- Ball seals PTFE
- Integrated stainless steel mounting inserts
- Lockable hand lever with ratchet settings

Option:

- Individual configuration of the valve (see form)
- Multifunctional module with integrated limit switches
- Pneumatic or electric actuators from +GF+

d [mm]	DN [mm]	PN	kv-value ($\Delta p=1$ bar) [l/min]	EPDM Code	FPM Code	kg
20	15	10	185	167 546 462	167 546 472	0.130
25	20	10	350	167 546 463	167 546 473	0.195
32	25	10	700	167 546 464	167 546 474	0.270
40	32	10	1000	167 546 465	167 546 475	0.465
50	40	10	1600	167 546 466	167 546 476	0.645
63	50	10	3100	167 546 467	167 546 477	1.230
 75	65	10	5000	167 546 468	167 546 478	
 90	80	10	7000	167 546 469	167 546 479	
 110	100	10	11000	167 546 470	167 546 480	

d [mm]	D [mm]	H [mm]	H1 [mm]	H2 [mm]	L [mm]	L1 [mm]	L2 [mm]	L4 [mm]	L5 [mm]	L6 [mm]	M	e [mm]
20	50	79	27	12	130	87	56	25	42	45	M6	1,9
25	58	88	30	12	143	108	65	25	50	58	M6	2,3
32	68	94	36	12	150	108	71	25	50	58	M6	3
40	84	113	44	15	171	140	85	45	66	75	M8	3,7
50	97	119	51	15	191	140	89	45	66	75	M8	4,6
63	124	141	64	15	220	165	101	45	78	87	M8	5,8
 75	166	149	85	15	266	270	136	70	64	206	M8	8.2
 90	200	161	105	15	264	270	141	70	64	206	M8	9.9
 110	238	178	123	22	301	320	164	120	64	256	M12	12

Spare parts for ball valve type 546 PP-H (DN10/15-50)

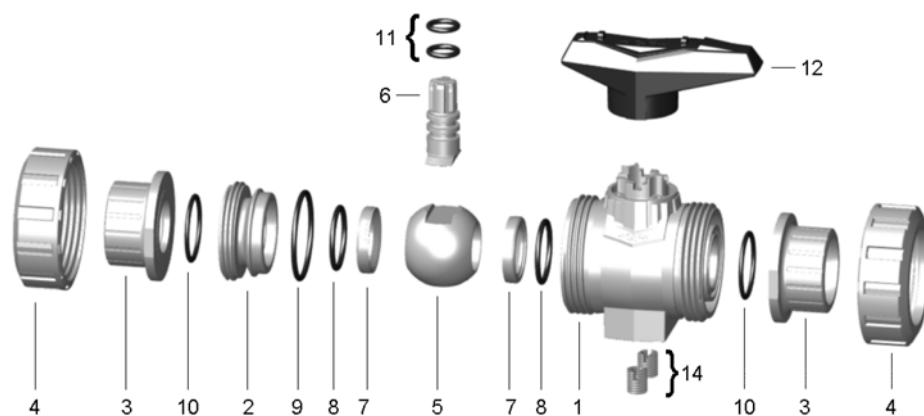

No.	Article / Material	Pieces	d16 DN10	d20 DN15	d25 DN20	d32 DN25	d40 DN32	d50 DN40	d63 DN50
	Central part		167 482 876	167 482 876	167 482 877	167 482 878	167 482 879	167 482 880	167 482 881
1	Body PP	1							
2	Union bush PP	1							
5	Ball PP	1							
6	Stem PP	1							
7	Ball seal PTFE	2							
8	Backing seal EPDM	1							
9	Body seal EPDM	1							
10	Face seal EPDM	2							
11	Stem seal EPDM	2							
12	Lever PP black	1							
14	Threaded bush Stainless steel	3							
	Central part		167 482 888	167 482 888	167 482 889	167 482 890	167 482 891	167 482 892	167 482 893
1	Body PP	1							
2	Union bush PP	1							
5	Ball PP	1							
6	Stem PP	1							
7	Ball seal PTFE	2							
8	Backing seal FPM	1							
9	Body seal FPM	1							
10	Face seal FPM	2							
11	Stem seal FPM	2							
12	Lever PP black	1							
14	Threaded bush Stainless steel	3							
	Ball set		167 484 125	167 484 125	167 484 126	167 484 127	167 484 128	167 484 129	167 484 130
5	Ball PP	1							
6	Stem PP	1							
7	Ball seal PTFE	2							
8	Backing seal EPDM	2							
9	Body seal EPDM	1							
11	Stem seal EPDM	2							

No.	Article / Material	Pieces	d16 DN10	d20 DN15	d25 DN20	d32 DN25	d40 DN32	d50 DN40	d63 DN50
5	Ball set		167 484 135	167 484 135	167 484 136	167 484 137	167 484 138	167 484 139	167 484 140
6	Ball PP	1							
7	Stem PP	1							
8	Ball seal PTFE	2							
8	Backing seal FPM	2							
9	Body seal FPM	1							
11	Stem seal FPM	2							
8	Seal set		161 486 400	161 486 400	161 486 401	161 486 402	161 486 403	161 486 404	161 486 405
9	Backing seal EPDM	2							
10	Body seal EPDM	1							
11	Face seal EPDM	2							
11	Stem seal EPDM	2							
8	Seal set		161 486 410	161 486 410	161 486 411	161 486 412	161 486 413	161 486 414	161 486 415
9	Backing seal FPM	2							
10	Body seal FPM	1							
11	Face seal FPM	2							
11	Stem seal FPM	2							
3	Connecting piece 546 PP-H (G30) with fusion socket metric	1	167 482 900	167 482 901	167 482 902	167 482 903	167 482 904	167 482 905	167 482 906
3	Connecting piece 546 PP-H (G32) with socket fusion spigot metric	1	167 482 922	167 482 923	167 482 924	167 482 925	167 482 926	167 482 927	167 482 928
3	Connecting piece 546 PP-H (G33) with threaded socket Rp fortified	1	167 482 911	167 482 912	167 482 913	167 482 914	167 482 915	167 482 916	167 482 917
3	Connecting piece 546 PP-H (G34) with threaded socket NPT fortified	1	167 482 966	167 482 967	167 482 968	167 482 969	167 482 970	167 482 971	167 482 972
3	Connecting piece 546 PP-H (G35) with butt fusion spigot IR Plus® SDR11 metric	1	-	167 482 945	167 482 946	167 482 947	167 482 948	167 482 949	167 482 950
3	Connecting piece 546 PP-H (G36) with butt fusion spigot SDR17,6 metric	1	-	-	-	-	167 482 937	167 482 938	167 482 939
3	Connecting piece 546 PP-H (G37) with butt fusion spigot long SDR11 metric	1	-	167 482 956	167 482 957	167 482 958	167 482 959	167 482 960	167 482 961
3	Connecting piece 546 PP-H (G63) subassembly with fixed flange serrated PP-H metric	1	-	167 484 160	167 484 161	167 484 162	167 484 163	167 484 164	167 484 165

No.	Article / Material	Pieces	d16 DN10	d20 DN15	d25 DN20	d32 DN25	d40 DN32	d50 DN40	d63 DN50
3	Connecting piece 546 PP-H (G73) subassembly with backing flange PP-ST ANSI	1	-	167 482 956	167 482 957	167 482 958	167 482 959	-	-
3	Connecting piece 546 PE 100 (G40) with fusion socket metric	1	193 480 175	193 480 176	193 480 177	193 480 178	193 480 179	193 480 180	193 480 181
3	Connecting piece 546 PE 100 (G41) with butt fusion spigot SDR11 metric	1	-	193 480 102	193 480 103	193 480 104	193 480 105	193 480 106	193 480 107
3	Connecting piece 546 PE 100 (G42) with butt fusion spigot SDR17,6 metric	1	-	-	-	-	193 480 086	193 480 087	193 480 088
3	Connecting piece 546 PE 100 (G43) with butt fusion spigot long SDR11 metric	1	-	193 480 152	193 480 153	193 480 154	193 480 155	193 480 156	193 480 157
3	Connecting piece 546 PVC-C (G11) with solvent cement socket metric	1	163 481 275	163 481 276	163 481 277	163 481 278	163 481 279	163 481 280	163 481 281
3	Connecting piece 546 PVC-C (G13) with solvent cement socket Inch ASTM	1	163 481 311	163 481 312	163 481 313	163 481 314	163 481 315	163 481 316	163 481 317
3	Connecting piece 546 PVC-C (G14) with solvent cement spigot metric	1	163 481 300	163 481 301	163 481 302	163 481 303	163 481 304	163 481 305	163 481 306
3	Connecting piece 546 PVC-C (G15) with threaded socket Rp	1	163 481 286	163 481 287	163 481 288	163 481 289	163 481 290	163 481 291	163 481 292
3	Connecting piece 546 PVC-C (G16) with threaded socket Rp fortified	1	163 481 400	163 481 401	163 481 402	163 481 403	163 481 404	163 481 405	163 481 406
3	Connecting piece 546 PVC-C (G17) with threaded socket NPT	1	163 481 322	163 481 323	163 481 324	163 481 325	163 481 326	163 481 327	163 481 328
4	Union nut 546 PP-H	1	167 482 712	167 482 712	167 482 713	167 482 714	167 482 715	167 482 716	167 482 717
12	Standard handle 546 red (K01)	1	167 484 088	167 484 088	167 484 089	167 484 090	167 484 091	167 484 092	167 484 093

No.	Article / Material	Pieces	d16 DN10	d20 DN15	d25 DN20	d32 DN25	d40 DN32	d50 DN40	d63 DN50
12	Standard handle 546 black (K02)	1	167 484 076	167 484 076	167 484 077	167 484 078	167 484 079	167 484 080	167 484 081
22	Multifunction handle 546 red (K11) with ratchet settings lockable	1	167 484 100	167 484 100	167 484 101	167 484 102	167 484 103	167 484 104	167 484 105
10	Face seal EPDM	1	748 410 059	748 410 059	748 410 106	748 410 151	748 410 062	748 410 003	748 410 231
10	Face seal FPM	1	749 410 059	749 410 059	749 410 106	749 410 151	749 410 062	749 410 003	749 410 231

Spare parts for ball valve type 546 PP-H (DN65-100)

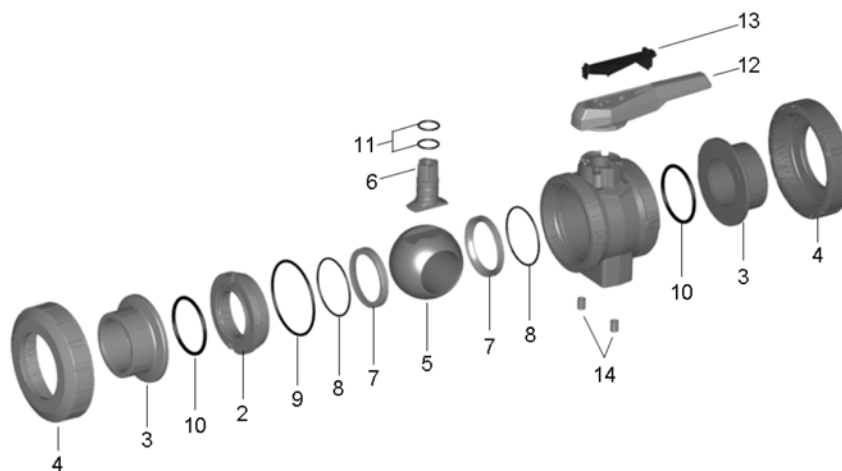

No.	Article / Material	Pieces	d75 DN65	d90 DN80	d110 DN100
	Central part		167 482 882	167 482 883	167 482 884
1	Body PP	1			
2	Union bush PP	1			
5	Ball PP	1			
6	Stem PP	1			
7	Ball seal PTFE	2			
8	Backing seal EPDM	1			
9	Body seal EPDM	1			
10	Face seal EPDM	2			
11	Stem seal EPDM	2			
12	Lever PP black	1			
13	handle clip	1			
14	Threaded bush Stainless steel	3			
	Central part		167 482 894	167 482 895	167 482 896
1	Body PP	1			
2	Union bush PP	1			
5	Ball PP	1			
6	Stem PP	1			
7	Ball seal PTFE	2			
8	Backing seal FPM	1			
9	Body seal FPM	1			
10	Face seal FPM	2			
11	Stem seal FPM	2			
12	Lever PP black	1			
13	handle clip	1			
14	Threaded bush Stainless steel	3			

No.	Article / Material	Pieces	d75 DN65	d90 DN80	d110 DN100
	Ball set		167 484 131	167 484 132	167 484 133
5	Ball PP	1			
6	Stem PP	1			
7	Ball seal PTFE	2			
8	Backing seal EPDM	2			
9	Body seal EPDM	1			
11	Stem seal EPDM	2			
	Ball set		167 484 141	167 484 142	167 484 143
5	Ball PP	1			
6	Stem PP	1			
7	Ball seal PTFE	2			
8	Backing seal FPM	2			
9	Body seal FPM	1			
11	Stem seal FPM	2			
	Seal set		161 486 406	161 486 407	161 486 408
8	Backing seal EPDM	2			
9	Body seal EPDM	1			
10	Face seal EPDM	2			
11	Stem seal EPDM	2			
	Seal set		161 486 416	161 486 417	161 486 418
8	Backing seal FPM	2			
9	Body seal FPM	1			
10	Face seal FPM	2			
11	Stem seal FPM	2			
3	Connecting piece 546 PP-H (G30) with fusion socket metric	1	167 482 907	167 482 908	167 482 909
3	Connecting piece 546 PP-H (G32) with socket fusion spigot metric	1	167 482 929	167 482 930	167 482 931
3	Connecting piece 546 PP-H (G35) with butt fusion spigot IR Plus® SDR11 metric	1	167 482 951	167 482 952	167 482 953
3	Connecting piece 546 PP-H (G36) with butt fusion spigot SDR17,6 metric	1	167 482 940	167 482 941	167 482 942
3	Connecting piece 546 (G73) subassembly with backing flange PP-ST ANSI	1	167 484 071	167 484 072	167 484 073
3	Connecting piece 546 (G77) subassembly with backing flange PP-GF JIS	1	167 484 025	167 484 026	167 484 027

No.	Article / Material	Pieces	d75 DN65	d90 DN80	d110 DN100
3	Connecting piece 546 (G72) subassembly with backing flange PP-ST ISO BS	1	167 484 418	167 484 419	167 484 420
3	Connecting piece 546 PE 100 (G43) with butt fusion spigot long SDR11 metric	1	193 480 158	193 480 159	193 480 160
3	Connecting piece 546 PE 100 (G44) with butt fusion spigot long SDR17,6 metric	1	193 480 168	193 480 169	193 480 170
4	Union nut 546 PP-H	1	167 482 718	167 482 719	167 482 720
12	Standard handle 546 red (K01)	1	167 484 094	167 484 095	167 484 096
12	Standard handle 546 black (K02)	1	167 484 082	167 484 083	167 484 084
10	Face seal EPDM	1	748 410 119	748 410 023	748 410 254
10	Face seal FPM	1	749 410 119	749 410 023	749 410 254

Ball Valves 323

Metering ball valve type 323 PP-H With fusion sockets

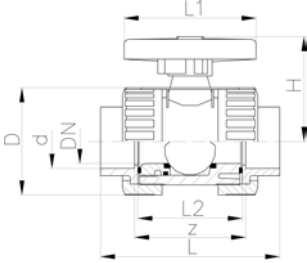

Model:

- For easy installation and removal
- Ball seals PTFE
- Angle of operation 180° with scale

d [mm]	DN [mm]	PN	kv-value ($\Delta p=1$ bar) [l/min]	EPDM Code	FPM Code	kg	
16	10	10	11	167 323 401	167 323 411	0.103	
20	15	10	20	167 323 402	167 323 412	0.104	

d [mm]	D [mm]	H [mm]	L [mm]	L1 [mm]	L2 [mm]	Z [mm]
16	46	50	98	78	62	72
20	46	50	101	78	62	73

Metering ball valve type 323 PP-H With butt fusion spigots S5/SDR11

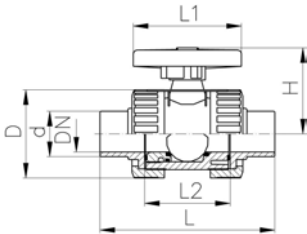

Model:

- For easy installation and removal
- Ball seals PTFE
- Angle of operation 180° with scale

d [mm]	DN [mm]	PN	kv-value ($\Delta p=1$ bar) [l/min]	EPDM Code	FPM Code	kg	D [mm]	H [mm]	L [mm]	L1 [mm]	L2 [mm]
20	15	10	20	167 323 482	167 323 492	0.106	46	50	130	78	62

Metering ball valve type 323 PP-H With socket fusion spigots

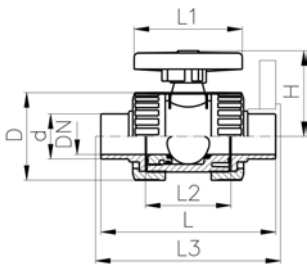

Model:

- For easy installation and removal
- Ball seals PTFE
- Angle of operation 180° with scale

d [mm]	DN [mm]	PN	kv-value ($\Delta p=1$ bar) [l/min]	EPDM Code	FPM Code	kg	D [mm]	H [mm]	L [mm]	L1 [mm]	L2 [mm]
16	10	10	11	167 323 441	167 323 451	0.100	46	50	109	78	62
20	15	10	20	167 323 442	167 323 452	0.100	46	50	124	78	62

Spare parts for metering ball valve type 323 PP-H

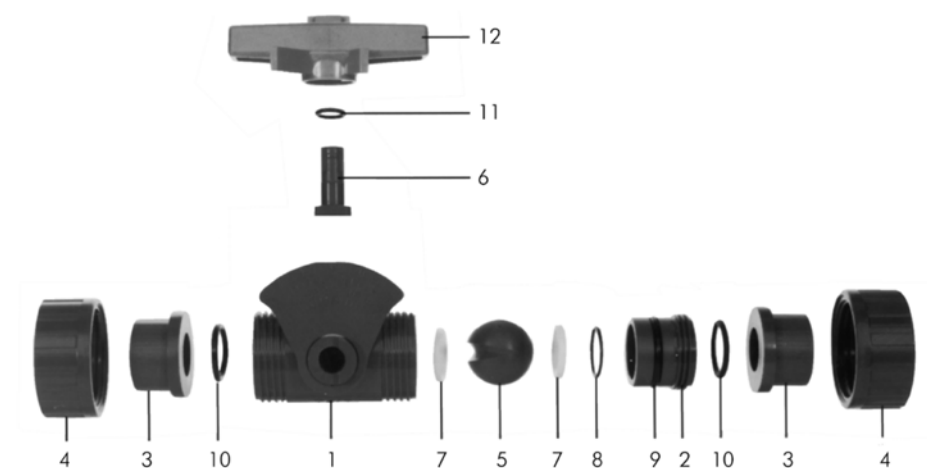

No.	Article / Material	Pieces	d16 DN10	d20 DN15
	Ball set		167 480 901	167 480 902
5	Ball PP	1		
7	Ball seal PTFE	2		
6	Stem PP	1		
11	Stem seal EPDM	1		
12	Lever ASA	1		
	Ball set		167 480 904	197 480 905
5	Ball PP	1		
7	Ball seal PTFE	2		
6	Stem PP	1		
11	Stem seal FPM	1		
12	Lever ASA	1		
8	Seal set		161 480 833	161 482 883
	Backing seal EPDM	2	No. 11, 1 Piece	No. 11, 1 Piece
9	Body seal EPDM	1		
10	Face seal EPDM	1		
11	Stem seal EPDM	2		
8	Seal set		161 482 892	161 482 892
	Backing seal FPM	2	No. 11, 1 Piece	No. 11, 1 Piece
9	Body seal FPM	1		
10	Face seal FPM	1		
11	Stem seal FPM	2		
2	Union bush PP-H	1	167 480 519	167 480 519
10	Face seal EPDM	2	748 410 042	748 410 042
10	Face seal FPM	2	749 410 042	749 410 042
3	Fusion socket PP-H	1	167 480 159	167 480 160
3	Socket fusion spigot PP-H	1	167 480 527	167 480 528
3	Butt fusion spigot PP-H SDR11	1	-	167 480 546
3	Fusion socket PE 80	1	173 480 000	173 480 001
4	Union nut PP-H	1	167 480 786	167 480 786
12	Lever ASA	1	160 480 130	160 480 130

Ball Valves 343

3-Way ball valve type 343 PP-H Horizontal/L-port With fusion sockets metric

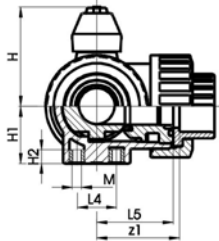
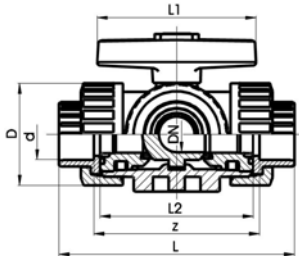
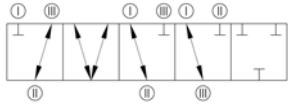

Model:

- L-port ball
- For easy installation and removal
- Ball seals PTFE
- Pneumatic or electric actuator available separately
- Angle of operation 360°, without turn limiter

d [mm]	DN [mm]	PN	kv-value ($\Delta p=1$ bar) [l/min]	EPDM Code	FPM Code	kg
16	10	10	49	167 343 001	167 343 011	0.141
20	15	10	77	167 343 002	167 343 012	0.141
25	20	10	146	167 343 003	167 343 013	0.254
32	25	10	260	167 343 004	167 343 014	0.346
40	32	10	437	167 343 005	167 343 015	0.568
50	40	10	667	167 343 006	167 343 016	0.919
63	50	10	1293	167 343 007	167 343 017	1.758

d [mm]	z [mm]	z1 [mm]	D [mm]	H [mm]	H1 [mm]	H2 [mm]	L [mm]	L1 [mm]	L2 [mm]	L4 [mm]	L5 [mm]	M
16	78	39	46	50	27	8	108	78	70	25	36	6
20	79	40	46	50	27	8	111	78	70	25	36	6
25	95	48	56	60	33	8	131	92	86	25	43	6
32	108	54	67	68	36	8	148	100	96	25	48	6
40	133	67	82	79	44	9	177	110	114	45	58	8
50	155	78	98	90	49	9	205	120	137	45	69	8
63	203	102	121	109	61	9	261	146	179	45	90	8



3-Way ball valve type 343 PP-H Horizontal/L-port With socket fusion spigots metric

Model:

- L-port ball
- For easy installation and removal
- Ball seals PTFE
- Pneumatic or electric actuator available separately
- Angle of operation 360°, without turn limiter

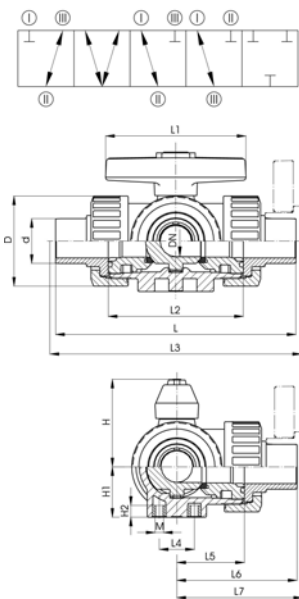

d [mm]	DN [mm]	PN	kv-value ($\Delta p=1$ bar) [l/min]	EPDM Code	FPM Code	kg
16	10	10	49	167 343 021	167 343 031	0.141
20	15	10	77	167 343 022	167 343 032	0.141
25	20	10	146	167 343 023	167 343 033	0.254
32	25	10	260	167 343 024	167 343 034	0.346
40	32	10	437	167 343 025	167 343 035	0.568
50	40	10	667	167 343 026	167 343 036	0.919
63	50	10	1293	167 343 027	167 343 037	1.758

d [mm]	D [mm]	H [mm]	H1 [mm]	H2 [mm]	L [mm]	L1 [mm]	L2 [mm]	L3 [mm]	L4 [mm]	L5 [mm]	L6 [mm]	L7 [mm]	M
16	46	50	27	8	119	78	70		25	36	60		6
20	46	50	27	8	133	78	70	136	25	36	67	68	6
25	56	60	33	8	155	92	86	158	25	43	78	79	6
32	67	68	36	8	170	100	96	173	25	48	85	87	6
40	82	79	44	9	201	110	114	204	45	58	101	102	8
50	98	90	49	9	236	120	137	239	45	69	118	120	8
63	121	109	61	9	286	146	179	299	45	90	143	150	8



3-Way ball valve type 343 PP-H Horizontal/L-port With threaded sockets Rp

Model:

- L-port ball
- For easy installation and removal
- Ball seals PTFE
- Pneumatic or electric actuator available separately
- Angle of operation 360°, without turn limiter

- Parallel female thread Rp

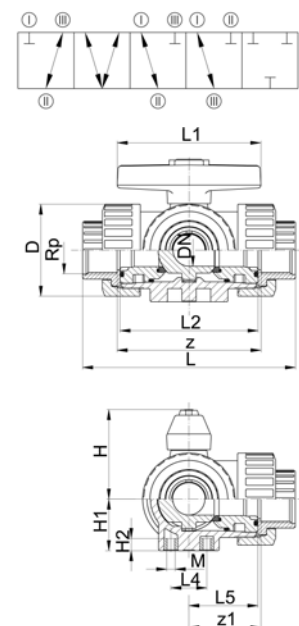

Rp [inch]	DN [mm]	PN	kv-value ($\Delta p=1$ bar) [l/min]	EPDM Code	FPM Code	kg
3/8	10	10	49	167 343 081	167 343 091	0.199
1/2	15	10	77	167 343 082	167 343 092	0.199
3/4	20	10	146	167 343 083	167 343 093	0.370
1	25	10	260	167 343 084	167 343 094	0.504
1 1/4	32	10	437	167 343 085	167 343 095	0.838
1 1/2	40	10	667	167 343 086	167 343 096	1.359
2	50	10	1293	167 343 087	167 343 097	2.622

Rp [inch]	z [mm]	z1 [mm]	D [mm]	H [mm]	H1 [mm]	H2 [mm]	L [mm]	L1 [mm]	L2 [mm]	L4 [mm]	L5 [mm]	M
3/8	76	38	46	50	27	8	108	78	70	25	36	6
1/2	76	38	46	50	27	8	111	78	70	25	36	6
3/4	90	45	56	60	33	8	131	92	86	25	43	6
1	100	50	67	68	36	8	148	100	96	25	48	6
1 1/4	122	61	82	79	44	9	176	110	114	45	58	8
1 1/2	152	76	98	90	49	9	206	120	137	45	69	8
2	200	100	121	109	61	9	262	146	179	45	90	8



3-Way ball valve type 343 PP-H Horizontal/L-port With threaded sockets NPT

Model:

- L-port ball
- For easy installation and removal
- Ball seals PTFE
- Pneumatic or electric actuator available separately
- Angle of operation 360°, without turn limiter
- Tapered female thread NPT

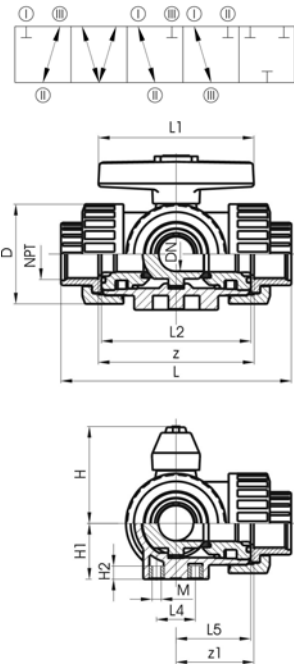

NPT [inch]	DN [mm]	PN	kv-value ($\Delta p=1$ bar) [l/min]	EPDM Code	FPM Code	kg
3/8	10	10	49	167 343 161	167 343 171	0.199
1/2	15	10	77	167 343 162	167 343 172	0.199
3/4	20	10	146	167 343 163	167 343 173	0.370
1	25	10	260	167 343 164	167 343 174	0.504
1 1/4	32	10	437	167 343 165	167 343 175	0.838
1 1/2	40	10	667	167 343 166	167 343 176	1.359
2	50	10	1293	167 343 167	167 343 177	2.622

NPT [inch]	z [mm]	z1 [mm]	D [mm]	H [mm]	H1 [mm]	H2 [mm]	L [mm]	L1 [mm]	L2 [mm]	L4 [mm]	L5 [mm]	M
3/8	76	38	46	50	27	8	108	78	70	25	36	6
1/2	76	38	46	50	27	8	111	78	70	25	36	6
3/4	90	45	56	60	33	8	131	92	86	25	43	6
1	100	50	67	68	36	8	148	100	96	25	48	6
1 1/4	122	61	82	79	44	9	176	110	114	45	58	8
1 1/2	152	76	98	90	49	9	206	120	137	45	69	8
2	200	100	121	109	61	9	262	146	179	45	90	8



3-Way ball valve type 343 PP-H Horizontal/L-port With butt fusion spigots S5/SDR11

Model:

- L-port ball
- For easy installation and removal
- Ball seals PTFE
- Pneumatic or electric actuator available separately
- Angle of operation 360°, without turn limiter

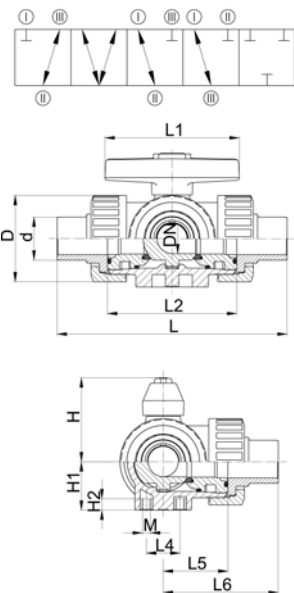

d [mm]	DN [mm]	PN	kv-value ($\Delta p=1$ bar) [l/min]	EPDM Code	FPM Code	kg
20	15	10	77	167 343 062	167 343 072	0.141
25	20	10	146	167 343 063	167 343 073	0.254
32	25	10	260	167 343 064	167 343 074	0.346
40	32	10	437	167 343 065	167 343 075	0.568
50	40	10	667	167 343 066	167 343 076	0.919
63	50	10	1293	167 343 067	167 343 077	1.758

d [mm]	D [mm]	H [mm]	H1 [mm]	H2 [mm]	L [mm]	L1 [mm]	L2 [mm]	L4 [mm]	L5 [mm]	L6 [mm]	M
20	46	50	27	8	140	78	70	25	36	70	6
25	56	60	33	8	156	92	86	25	43	78	6
32	67	68	36	8	168	100	96	25	48	84	6
40	82	79	44	9	198	110	114	45	58	99	8
50	98	90	49	9	233	120	137	45	69	117	8
63	121	109	61	9	284	146	179	45	90	142	8



3-Way ball valve type 343 PP-H Horizontal/L-port With butt fusion spigots S8/SDR17

Model:

- L-port ball
- For easy installation and removal
- Ball seals PTFE
- Pneumatic or electric actuator available separately
- Angle of operation 360°, without turn limiter

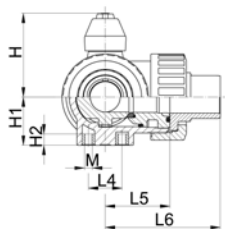
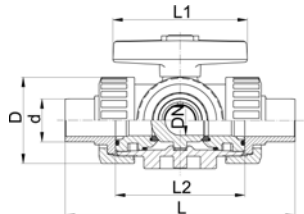
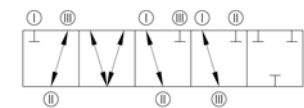

d [mm]	DN [mm]	PN	kv-value ($\Delta p=1$ bar) [l/min]	EPDM Code	FPM Code	kg
20	15	6	77	167 343 042	167 343 052	0.141
25	20	6	146	167 343 043	167 343 053	0.254
32	25	6	260	167 343 044	167 343 054	0.346
40	32	6	437	167 343 045	167 343 055	0.568
50	40	6	667	167 343 046	167 343 056	0.919
63	50	6	1293	167 343 047	167 343 057	1.758

d [mm]	D [mm]	H [mm]	H1 [mm]	H2 [mm]	L [mm]	L1 [mm]	L2 [mm]	L4 [mm]	L5 [mm]	L6 [mm]	M
20	46	50	27	8	140	78	70	25	36	70	6
25	56	60	33	8	156	92	86	25	43	78	6
32	67	68	36	8	168	100	96	25	48	84	6
40	82	79	44	9	198	110	114	45	58	99	8
50	98	90	49	9	233	120	137	45	69	117	8
63	121	109	61	9	284	146	179	45	90	142	8



3-Way ball valve type 343 PP-H Horizontal/T-port With fusion sockets metric

Model:

- For easy installation and removal
- Ball seals PTFE
- Pneumatic or electric actuator available separately
- Angle of operation 90°, without turn limiter

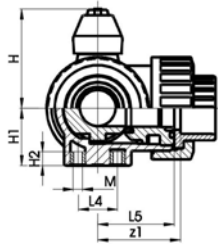
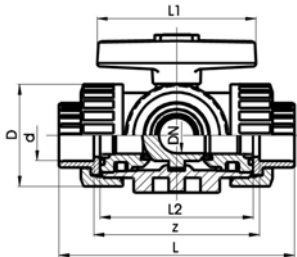
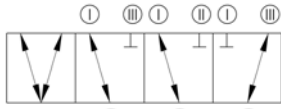

d [mm]	DN [mm]	PN	kv-value ($\Delta p=1$ bar) [l/min]	EPDM Code	FPM Code	kg
16	10	10	140	167 343 201	167 343 211	0.141
20	15	10	200	167 343 202	167 343 212	0.141
25	20	10	470	167 343 203	167 343 213	0.254
32	25	10	793	167 343 204	167 343 214	0.346
40	32	10	1290	167 343 205	167 343 215	0.568
50	40	10	1910	167 343 206	167 343 216	0.919
63	50	10	3100	167 343 207	167 343 217	1.758

d [mm]	z [mm]	z1 [mm]	D [mm]	H [mm]	H1 [mm]	H2 [mm]	L [mm]	L1 [mm]	L2 [mm]	L4 [mm]	L5 [mm]	M
16	78	39	46	50	27	8	108	78	70	25	36	6
20	79	40	46	50	27	8	111	78	70	25	36	6
25	95	48	56	60	33	8	131	92	86	25	43	6
32	108	54	67	68	36	8	148	100	96	25	48	6
40	133	67	82	79	44	9	177	110	114	45	58	8
50	155	78	98	90	49	9	205	120	137	45	69	8
63	203	102	121	109	61	9	261	146	179	45	90	8



3-Way ball valve type 343 PP-H Horizontal/T-port With socket fusion spigots metric

Model:

- For easy installation and removal
- Ball seals PTFE
- Pneumatic or electric actuator available separately
- Angle of operation 90°, without turn limiter

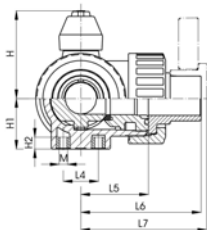
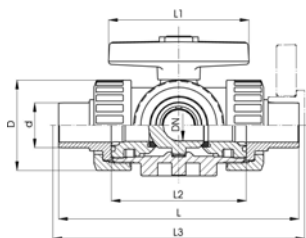
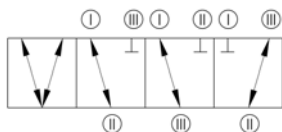

d [mm]	DN [mm]	PN	kv-value ($\Delta p=1$ bar) [l/min]	EPDM Code	FPM Code	kg
16	10	10	140	167 343 221	167 343 231	0.141
20	15	10	200	167 343 222	167 343 232	0.141
25	20	10	470	167 343 223	167 343 233	0.254
32	25	10	793	167 343 224	167 343 234	0.346
40	32	10	1290	167 343 225	167 343 235	0.568
50	40	10	1910	167 343 226	167 343 236	0.919
63	50	10	3100	167 343 227	167 343 237	1.758

d [mm]	D [mm]	H [mm]	H1 [mm]	H2 [mm]	L [mm]	L1 [mm]	L2 [mm]	L3 [mm]	L4 [mm]	L5 [mm]	L6 [mm]	L7 [mm]	M
16	46	50	27	8	119	78	70		25	36	60		6
20	46	50	27	8	133	78	70	136	25	36	67	68	6
25	56	60	33	8	155	92	86	158	25	43	78	79	6
32	67	68	36	8	170	100	96	173	25	48	85	87	6
40	82	79	44	9	201	110	114	204	45	58	101	102	8
50	98	90	49	9	236	120	137	239	45	69	118	120	8
63	121	109	61	9	286	146	179	299	45	90	143	150	8



3-Way ball valve type 343 PP-H Horizontal/T-port With threaded sockets Rp

Model:

- For easy installation and removal
- Ball seals PTFE
- Pneumatic or electric actuator available separately
- Angle of operation 90°, without turn limiter
- Parallel female thread Rp

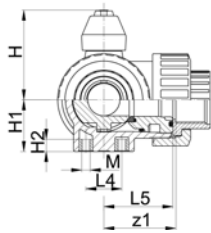
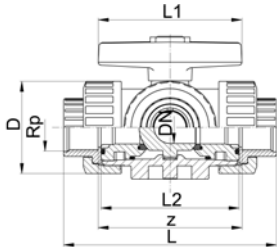
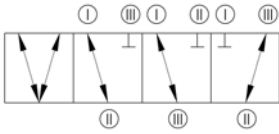

Rp [inch]	DN [mm]	PN	kv-value ($\Delta p=1$ bar) [l/min]	EPDM Code	FPM Code	kg
3/8	10	10	140	167 343 281	167 343 291	0.199
1/2	15	10	200	167 343 282	167 343 292	0.199
3/4	20	10	470	167 343 283	167 343 293	0.370
1	25	10	793	167 343 284	167 343 294	0.504
1 1/4	32	10	1290	167 343 285	167 343 295	0.838
1 1/2	40	10	1910	167 343 286	167 343 296	1.359
2	50	10	3100	167 343 287	167 343 297	2.622

Rp [inch]	z [mm]	z1 [mm]	D [mm]	H [mm]	H1 [mm]	H2 [mm]	L [mm]	L1 [mm]	L2 [mm]	L4 [mm]	L5 [mm]	M
3/8	76	38	46	50	27	8	108	78	70	25	36	6
1/2	76	38	46	50	27	8	111	78	70	25	36	6
3/4	90	45	56	60	33	8	131	92	86	25	43	6
1	100	50	67	68	36	8	148	100	96	25	48	6
1 1/4	122	61	82	79	44	9	176	110	114	45	58	8
1 1/2	152	76	98	90	49	9	206	120	137	45	69	8
2	200	100	121	109	61	9	262	146	179	45	90	8



3-Way ball valve type 343 PP-H Horizontal/T-port With threaded sockets NPT

Model:

- For easy installation and removal
- Ball seals PTFE
- Pneumatic or electric actuator available separately
- Angle of operation 90°, without turn limiter
- Tapered female thread NPT

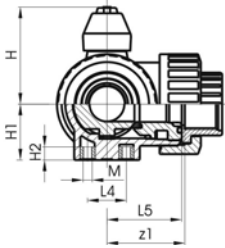
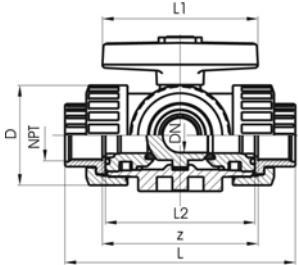
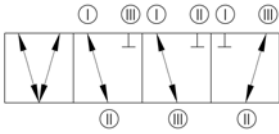

NPT [inch]	DN [mm]	PN	kv-value ($\Delta p=1$ bar) [l/min]	EPDM Code	FPM Code	kg
3/8	10	10	140	167 343 361	167 343 371	0.199
1/2	15	10	200	167 343 362	167 343 372	0.199
3/4	20	10	470	167 343 363	167 343 373	0.370
1	25	10	793	167 343 364	167 343 374	0.504
1 1/4	32	10	1290	167 343 365	167 343 375	0.838
1 1/2	40	10	1910	167 343 366	167 343 376	1.359
2	50	10	3100	167 343 367	167 343 377	2.622

NPT [inch]	z [mm]	z1 [mm]	D [mm]	H [mm]	H1 [mm]	H2 [mm]	L [mm]	L1 [mm]	L2 [mm]	L4 [mm]	L5 [mm]	M
3/8	76	38	46	50	27	8	108	78	70	25	36	6
1/2	76	38	46	50	27	8	111	78	70	25	36	6
3/4	90	45	56	60	33	8	131	92	86	25	43	6
1	100	50	67	68	36	8	148	100	96	25	48	6
1 1/4	122	61	82	79	44	9	176	110	114	45	58	8
1 1/2	152	76	98	90	49	9	206	120	137	45	69	8
2	200	100	121	109	61	9	262	146	179	45	90	8



3-Way ball valve type 343 PP-H Horizontal/T-port With butt fusion spigots S5/SDR11

Model:

- For easy installation and removal
- Ball seals PTFE
- Pneumatic or electric actuator available separately
- Angle of operation 90°, without turn limiter

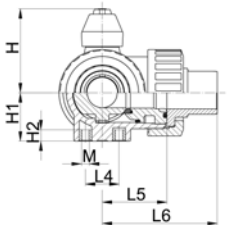
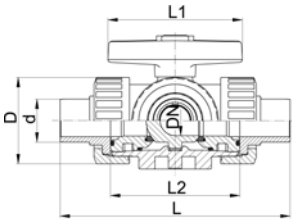
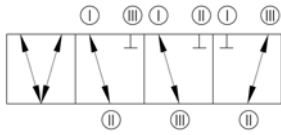

d [mm]	DN [mm]	PN	kv-value ($\Delta p=1$ bar) [l/min]	EPDM Code	FPM Code	kg
20	15	10	200	167 343 262	167 343 272	0.141
25	20	10	470	167 343 263	167 343 273	0.254
32	25	10	793	167 343 264	167 343 274	0.346
40	32	10	1290	167 343 265	167 343 275	0.568
50	40	10	1910	167 343 266	167 343 276	0.919
63	50	10	3100	167 343 267	167 343 277	1.758

d [mm]	D [mm]	H [mm]	H1 [mm]	H2 [mm]	L [mm]	L1 [mm]	L2 [mm]	L4 [mm]	L5 [mm]	L6 [mm]	M
20	46	50	27	8	140	78	70	25	36	70	6
25	56	60	33	8	156	92	86	25	43	78	6
32	67	68	36	8	168	100	96	25	48	84	6
40	82	79	44	9	198	110	114	45	58	99	8
50	98	90	49	9	233	120	137	45	69	117	8
63	121	109	61	9	284	146	179	45	90	142	8



3-Way ball valve type 343 PP-H Horizontal/T-port With butt fusion spigots S8/SDR17

Model:

- For easy installation and removal
- Ball seals PTFE
- Pneumatic or electric actuator available separately
- Angle of operation 90°, without turn limiter

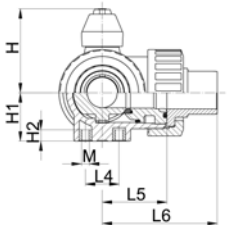
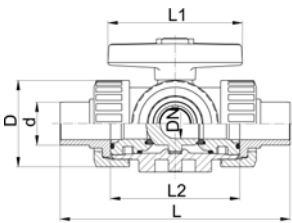
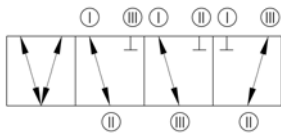

d [mm]	DN [mm]	PN	kv-value ($\Delta p=1$ bar) [l/min]	EPDM Code	FPM Code	kg
20	15	6	200	167 343 242	167 343 252	0.141
25	20	6	470	167 343 243	167 343 253	0.254
32	25	6	793	167 343 244	167 343 254	0.346
40	32	6	1290	167 343 245	167 343 255	0.568
50	40	6	1910	167 343 246	167 343 256	0.919
63	50	6	3100	167 343 247	167 343 257	1.758

d [mm]	D [mm]	H [mm]	H1 [mm]	H2 [mm]	L [mm]	L1 [mm]	L2 [mm]	L4 [mm]	L5 [mm]	L6 [mm]	M
20	46	50	27	8	140	78	70	25	36	70	6
25	56	60	33	8	156	92	86	25	43	78	6
32	67	68	36	8	168	100	96	25	48	84	6
40	82	79	44	9	198	110	114	45	58	99	8
50	98	90	49	9	233	120	137	45	69	117	8
63	121	109	61	9	284	146	179	45	90	142	8

Spare parts for ball valve type 343 PP-H

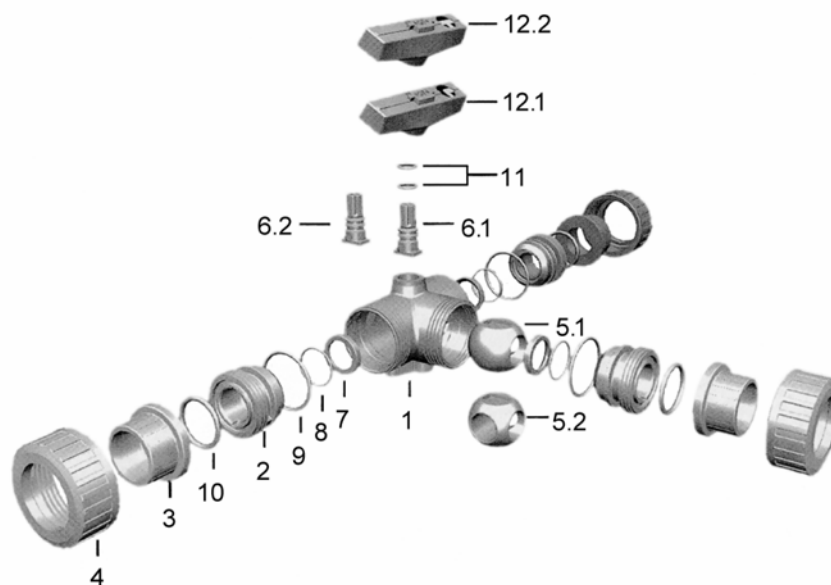

No.	Article / Material	Pieces	d16 DN 10	d20 DN 15	d25 DN 20	d32 DN 25	d40 DN 32	d50 DN 40	d63 DN 50
8	Seal set		161 484 941	161 484 941	161 484 942	161 484 943	161 484 944	161 484 945	161 484 946
8	Backing seal EPDM	3							
9	Body seal EPDM	3							
10	Face seal EPDM	3							
11	Stem seal EPDM	2							
8	Seal set		161 484 951	161 484 951	161 484 952	161 484 953	161 484 954	161 484 955	161 484 956
8	Backing seal FPM	3							
9	Body seal FPM	3							
10	Face seal FPM	3							
11	Stem seal FPM	2							
5.1	Ball set L-port		167 482 190	167 482 190	167 482 191	167 482 192	167 482 193	167 482 194	167 482 195
5.1	L-port ball PP	1							
7	Ball seal PTFE	3							
6.1	Stem PP	1							
11	Stem seal EPDM	2							
12.1	Lever ASA	1							
5.1	Ball set L-port		167 482 202	167 482 202	167 482 203	167 482 204	167 482 205	167 482 206	167 482 207
5.1	L-port ball PP	1							
7	Ball seal PTFE	3							
6.1	Stem PP	1							
11	Stem seal FPM	2							
12.1	Lever ASA	1							
5.2	Ball set T-port		167 482 214	167 482 214	167 482 215	167 482 216	167 482 217	167 482 218	167 482 219
5.2	T-port ball PP	1							
7	Ball seal PTFE	3							
6.2	Stem PP	1							
11	Stem seal EPDM	2							
12.2	Lever ASA	1							

No.	Article / Material	Pieces	d16 DN 10	d20 DN 15	d25 DN 20	d32 DN 25	d40 DN 32	d50 DN 40	d63 DN 50
	Ball set T-port		167 482 226	167 482 226	167 482 227	167 482 228	167 482 229	167 482 230	167 482 231
5.2	T-port ball PP	1							
7	Ball seal PTFE	3							
6.2	Stem PP	1							
11	Stem seal FPM	2							
12.2	Lever ASA	1							
	Central part L-port		167 482 137	167 482 137	167 482 138	167 482 139	167 482 140	167 482 141	167 482 142
1	Body PP	1							
5.1	L-port ball PP	1							
7	Ball seal PTFE	3							
8	Backing seal EPDM	3							
9	Body seal EPDM	3							
2	Union bush PP	3							
6.1	Stem PP	1							
11	Stem seal EPDM	2							
12.1	Lever ASA	1							
	Central part L-port		167 482 148	167 482 148	167 482 149	167 482 150	167 482 151	167 482 152	167 482 153
1	Body PP	1							
5.1	L-port ball PP	1							
7	Ball seal PTFE	3							
8	Backing seal FPM	3							
9	Body seal FPM	3							
2	Union bush PP	3							
6.1	Stem PP	1							
11	Stem seal FPM	2							
12.1	Lever ASA	1							
	Central part T-port		167 482 159	167 482 159	167 482 160	167 482 161	167 482 162	167 482 163	167 482 164
1	Body PP	1							
5.2	T-port ball PP	1							
7	Ball seal PTFE	3							
8	Backing seal EPDM	3							
9	Body seal EPDM	3							
2	Union bush PP	3							
6.2	Stem PP	1							
11	Stem seal EPDM	2							
12.2	Lever ASA	1							
	Central part T-port		167 482 170	167 482 170	167 482 171	167 482 172	167 482 173	167 482 174	167 482 175
1	Body PP	1							
5.2	T-port ball PP	1							
7	Ball seal PTFE	3							
8	Backing seal FPM	3							
9	Body seal FPM	3							
2	Union bush PP	3							
6.2	Stem PP	1							
11	Stem seal FPM	2							
12.2	Lever ASA	1							

No.	Article / Material	Pieces	d16 DN 10	d20 DN 15	d25 DN 20	d32 DN 25	d40 DN 32	d50 DN 40	d63 DN 50
3	Fusion socket PP-H	1	167 480 159	167 480 160	167 480 161	167 480 162	167 480 163	167 480 164	167 480 165
3	Socket fusion spigot PP-H	1	167 480 527	167 480 528	167 480 529	167 480 530	167 480 531	167 480 532	167 480 533
3	Threaded socket PP-H	1	167 480 166	167 480 167	167 480 168	167 480 169	167 480 170	167 480 171	167 480 172
3	Threaded socket PP-H	1	167 480 452	167 480 453	167 480 454	167 480 455	167 480 456	167 480 457	167 480 458
3	Butt fusion spigot long PP-H SDR11	1	-	167 482 546	167 482 547	167 482 548	167 482 549	167 482 550	167 482 551
3	Butt fusion spigot PP-H	1	-	167 480 546	167 480 547	167 480 548	167 480 549	167 480 550	167 480 551
3	Butt fusion spigot PP-H	1	-	167 480 537	167 480 538	167 480 539	167 480 540	167 480 541	167 480 542
3	Fusion socket PE 80	1	173 480 000	173 480 001	173 480 002	173 480 003	173 480 004	173 480 005	173 480 006
3	Butt fusion spigot long PE 100 SDR11	1	-	193 480 127	193 480 128	193 480 129	193 480 130	193 480 131	193 480 132
3	Butt fusion spigot PE 100	1	193 480 026	193 480 027	193 480 028	193 480 029	193 480 030	193 480 031	193 480 032
3	Butt fusion spigot PE 100	1	-	-	193 480 014	193 480 015	193 480 016	193 480 017	193 480 018
10	Face seal EPDM		748 410 042	748 410 042	748 410 116	748 410 103	748 410 027	748 410 010	748 410 011
10	Face seal FPM		749 410 042	749 410 042	749 410 116	749 410 103	749 410 027	749 410 010	749 410 011
4	Union nut PP-H	1	167 480 786	167 480 786	167 480 787	167 480 788	167 480 789	167 480 790	167 480 791

Diaphragm Valves 314

Diaphragm valve type 314 PP-H With fusion sockets metric

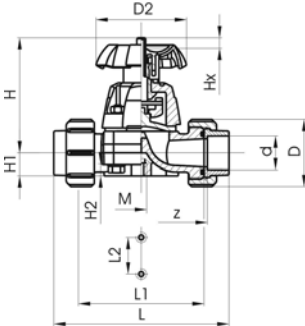

Model:

- For easy installation and removal
- Short overall length

Option:

- Handwheel with built in locking mechanism

d [mm]	DN [mm]	PN	kv-value ($\Delta p=1$ bar) [l/min]	NBR Code	EPDM Code	CSM Code	PTFE with EPDM supporting diaphragm Code
20	15	10	72	167 314 402	167 314 417	167 314 447	167 314 432
25	20	10	137	167 314 403	167 314 418	167 314 448	167 314 433
32	25	10	207	167 314 404	167 314 419	167 314 449	167 314 434
40	32	10	354	167 314 405	167 314 420	167 314 450	167 314 435
50	40	10	517	167 314 406	167 314 421	167 314 451	167 314 436
63	50	10	713	167 314 407	167 314 422	167 314 452	167 314 437

d [mm]	DN [mm]	PN	kv-value ($\Delta p=1$ bar) [l/min]	FPM Code	kg
20	15	10	72	167 314 462	0.380
25	20	10	137	167 314 463	0.560
32	25	10	207	167 314 464	0.760
40	32	10	354	167 314 465	1.220
50	40	10	517	167 314 466	1.600
63	50	10	713	167 314 467	2.780

d [mm]	z [mm]	D [mm]	D2 [mm]	L [mm]	L1 [mm]	L2 [mm]	H [mm]	H1 [mm]	H2 [mm]	M	Lift = Hx [mm]
20	100	47	80	128	90	25	90	14	12	M6	8
25	118	57	80	150	108	25	101	18	12	M6	11
32	126	64	94	162	116	25	117	21	12	M6	13
40	144	78	117	184	134	45	127	26	15	M8	16
50	164	89	117	210	154	45	139	33	15	M8	21
63	194	109	152	248	184	45	172	39	15	M8	28

Diaphragm valve type 314 PP-H With butt fusion spigots S5/SDR11

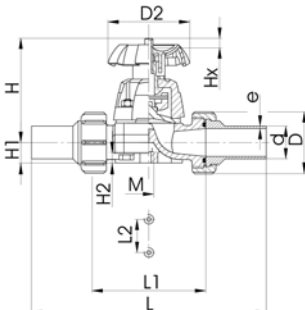

Model:

- For easy installation and removal
- Short overall length

Option:

- Handwheel with built in locking mechanism

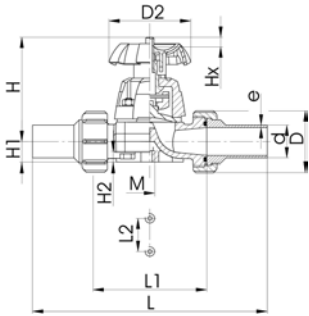

d [mm]	DN [mm]	PN	kv-value ($\Delta p=1$ bar) [l/min]	NBR Code	EPDM Code	CSM Code	PTFE with EPDM supporting diaphragm Code
20	15	10	72	167 314 502	167 314 517	167 314 547	167 314 532
25	20	10	137	167 314 503	167 314 518	167 314 548	167 314 533
32	25	10	207	167 314 504	167 314 519	167 314 549	167 314 534
40	32	10	354	167 314 505	167 314 520	167 314 550	167 314 535
50	40	10	517	167 314 506	167 314 521	167 314 551	167 314 536
63	50	10	713	167 314 507	167 314 522	167 314 552	167 314 537

d [mm]	DN [mm]	PN	kv-value ($\Delta p=1$ bar) [l/min]	FPM Code	kg
20	15	10	72	167 314 562	0.395
25	20	10	137	167 314 563	0.590
32	25	10	207	167 314 564	0.800
40	32	10	354	167 314 565	1.270
50	40	10	517	167 314 566	1.670
63	50	10	713	167 314 567	2.890

d [mm]	D [mm]	D2 [mm]	L [mm]	L1 [mm]	L2 [mm]	H [mm]	H1 [mm]	H2 [mm]	M	Lift = Hx [mm]	e [mm]
20	47	80	196	90	25	90	14	12	M6	8	1,9
25	57	80	221	108	25	102	18	12	M6	11	2,3
32	64	94	234	116	25	119	21	12	M6	13	3
40	78	117	260	134	45	126	26	15	M8	16	3,7
50	89	117	284	154	45	139	33	15	M8	21	4,6
63	109	152	321	184	45	172	39	15	M8	28	5,8



Diaphragm valve type 314 PP-H With fusion sockets PE80 metric

Model:

- For easy installation and removal
- Short overall length

Option:

- Handwheel with built in locking mechanism

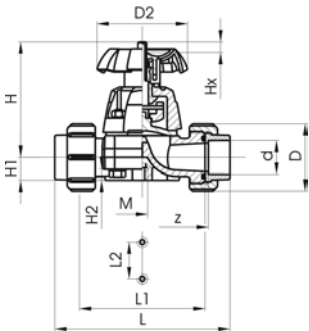

d [mm]	DN [mm]	PN	kv-value ($\Delta p=1$ bar) [l/min]	NBR Code	EPDM Code	CSM Code	PTFE with EPDM supporting diaphragm Code
20	15	10	72	167 314 602	167 314 617	167 314 647	167 314 632
25	20	10	137	167 314 603	167 314 618	167 314 648	167 314 633
32	25	10	207	167 314 604	167 314 619	167 314 649	167 314 634
40	32	10	354	167 314 605	167 314 620	167 314 650	167 314 635
50	40	10	517	167 314 606	167 314 621	167 314 651	167 314 636
63	50	10	713	167 314 607	167 314 622	167 314 652	167 314 637

d [mm]	DN [mm]	PN	kv-value ($\Delta p=1$ bar) [l/min]	FPM Code	kg
20	15	10	72	167 314 662	0.380
25	20	10	137	167 314 663	0.560
32	25	10	207	167 314 664	0.760
40	32	10	354	167 314 665	1.220
50	40	10	517	167 314 666	1.600
63	50	10	713	167 314 667	2.780

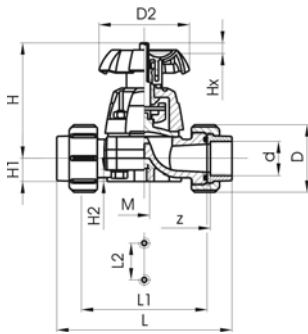

d [mm]	z [mm]	D [mm]	D2 [mm]	L [mm]	L1 [mm]	L2 [mm]	H [mm]	H1 [mm]	H2 [mm]	M	Lift = Hx [mm]
20	100	47	80	128	90	25	90	14	12	M6	8
25	118	57	80	150	108	25	101	18	12	M6	11
32	126	64	94	162	116	25	117	21	12	M6	13
40	144	78	117	184	134	45	127	26	15	M8	16
50	164	89	117	210	154	45	139	33	15	M8	21
63	194	109	152	248	184	45	172	39	15	M8	28



Diaphragm valve type 314 PP-H With butt fusion spigots PE100 S5/SDR11

Model:

- For easy installation and removal
- Short overall length

Option:

- Handwheel with built in locking mechanism

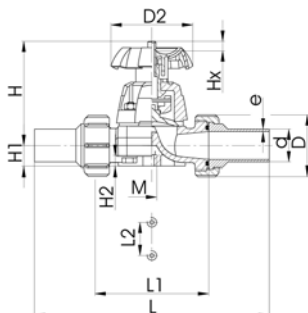

d [mm]	DN [mm]	PN	kv-value ($\Delta p=1$ bar) [l/min]	NBR Code	EPDM Code	CSM Code	PTFE with EPDM supporting diaphragm Code
20	15	10	72	167 314 702	167 314 717	167 314 747	167 314 732
25	20	10	137	167 314 703	167 314 718	167 314 748	167 314 733
32	25	10	207	167 314 704	167 314 719	167 314 749	167 314 734
40	32	10	354	167 314 705	167 314 720	167 314 750	167 314 735
50	40	10	517	167 314 706	167 314 721	167 314 751	167 314 736
63	50	10	713	167 314 707	167 314 722	167 314 752	167 314 737

d [mm]	DN [mm]	PN	kv-value ($\Delta p=1$ bar) [l/min]	FPM Code	kg
20	15	10	72	167 314 762	0.395
25	20	10	137	167 314 763	0.590
32	25	10	207	167 314 764	0.800
40	32	10	354	167 314 765	1.270
50	40	10	517	167 314 766	1.270
63	50	10	713	167 314 767	2.890

d [mm]	D [mm]	D2 [mm]	L [mm]	L1 [mm]	L2 [mm]	H [mm]	H1 [mm]	H2 [mm]	M	Lift = Hx [mm]	e [mm]
20	47	80	196	90	25	90	14	12	M6	8	1,9
25	57	80	221	108	25	102	18	12	M6	11	2,3
32	64	94	234	116	25	119	21	12	M6	13	3
40	78	117	260	134	45	126	26	15	M8	16	3,7
50	89	117	284	154	45	139	33	15	M8	21	4,6
63	109	152	321	184	45	172	39	15	M8	28	5,8

Spare parts for diaphragm valve type 314 PP-H

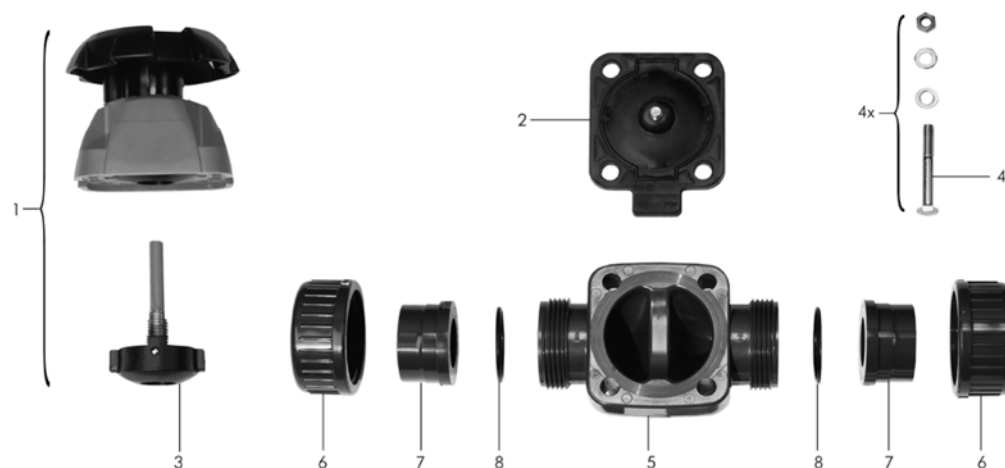

No.	Article / Material	Pieces	d20 DN 15	d25 DN 20	d32 DN 25	d40 DN 32	d50 DN 40	d63 DN 50
1	Bonnet complete (without diaphragm) elastomer diaphragm	1	161 484 625	161 484 626	161 484 627	161 484 628	161 484 629	161 484 630
2	Diaphragm NBR	1	161 311 710	161 311 711	161 311 712	161 311 713	161 311 714	161 311 715
2	Diaphragm EPDM	1	161 481 022	161 481 023	161 481 024	161 481 025	161 481 026	161 481 027
2	Diaphragm FPM	1	161 484 152	161 484 153	161 484 154	161 484 155	161 484 156	161 484 157
2	Diaphragm PTFE/EPDM	1	161 311 698	161 311 699	161 311 700	161 311 701	161 311 702	161 311 703
2	Diaphragm PTFE/FPM	1	161 481 926	161 481 927	161 481 928	161 481 929	161 481 930	161 481 931
2	Diaphragm CSM	1	161 311 728	161 311 729	161 311 730	161 311 731	161 311 732	161 311 733
3	Pressure spindle PTFE diaphragm	1	161 484 696	161 484 697	161 484 698	161 484 699	161 484 700	161 484 701
4	Fastening set Stainless steel	1	161 484 704	161 484 705	161 484 706	161 484 707	161 484 708	161 484 709
5	Valve body PP-H	1	167 481 977	167 481 978	167 481 979	167 481 980	167 481 981	167 481 982
6	Union nut PP	1	727 690 405	727 690 406	727 690 407	727 690 408	727 690 409	727 690 410
3	Fusion socket PP-H	1	727 600 106	727 600 107	727 600 108	727 600 109	727 600 110	727 600 111
7	Butt fusion spigot PE 100 SDR11	1	753 608 606	753 608 607	753 608 608	753 608 609	753 608 610	753 608 611
7	Butt fusion spigot PP-H SDR11 (IR-Plus®) compatible	1	727 608 506	727 608 507	727 608 508	727 608 509	727 608 510	727 608 511
7	Fusion socket PE 80	1	734 600 106	734 600 107	734 600 108	734 600 109	734 600 110	734 600 111
7	Butt fusion spigot long PE 100 SDR11	1	753 608 616	753 608 617	753 608 618	753 608 619	753 608 620	753 608 621
8	O-ring seal EPDM	1	748 410 006	748 410 007	748 410 008	748 410 009	748 410 010	748 410 011
8	O-ring seal FPM	1	749 410 006	749 410 007	749 410 008	749 410 009	749 410 010	749 410 011

Diaphragm Valves 315

Diaphragm valve type 315 PP-H With socket fusion spigots

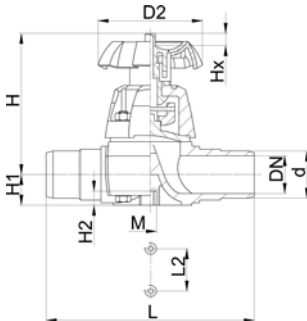

Model:

- Overall length EN 558-1

Option:

- Handwheel with built in locking mechanism

d [mm]	DN [mm]	PN	kv-value ($\Delta p=1$ bar) [l/min]	NBR Code	EPDM Code	CSM Code	PTFE with EPDM supporting diaphragm Code
20	15	10	72	167 315 402	167 315 417	167 315 447	167 315 432
25	20	10	137	167 315 403	167 315 418	167 315 448	167 315 433
32	25	10	207	167 315 404	167 315 419	167 315 449	167 315 434
40	32	10	354	167 315 405	167 315 420	167 315 450	167 315 435
50	40	10	517	167 315 406	167 315 421	167 315 451	167 315 436
63	50	10	713	167 315 407	167 315 422	167 315 452	167 315 437

d [mm]	DN [mm]	PN	kv-value ($\Delta p=1$ bar) [l/min]	FPM Code	kg
20	15	10	72	167 315 492	0.267
25	20	10	137	167 315 493	0.370
32	25	10	207	167 315 494	0.673
40	32	10	354	167 315 495	0.795
50	40	10	517	167 315 496	1.168
63	50	10	713	167 315 497	2.088

d [mm]	D2 [mm]	H [mm]	H1 [mm]	H2 [mm]	L [mm]	L2 [mm]	M	Lift = Hx [mm]
20	80	90	14	12	124	25	M6	7
25	80	101	18	12	144	25	M6	10
32	94	117	22	12	154	25	M6	12
40	117	127	26	15	174	45	M8	16
50	117	139	32	15	194	45	M8	19
63	152	172	39	15	223	45	M8	27

Diaphragm valve type 315 PP-H With butt fusion spigots S5/SDR11

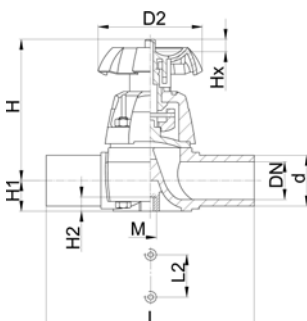

Option:

- Handwheel with built in locking mechanism

d [mm]	DN [mm]	PN	kv-value ($\Delta p=1$ bar) [l/min]	NBR Code	EPDM Code	CSM Code	PTFE with EPDM supporting diaphragm Code
20	15	10	72	167 315 502	167 315 517	167 315 547	167 315 532
25	20	10	137	167 315 503	167 315 518	167 315 548	167 315 533
32	25	10	207	167 315 504	167 315 519	167 315 549	167 315 534
40	32	10	354	167 315 505	167 315 520	167 315 550	167 315 535
50	40	10	517	167 315 506	167 315 521	167 315 551	167 315 536
63	50	10	713	167 315 507	167 315 522	167 315 552	167 315 537

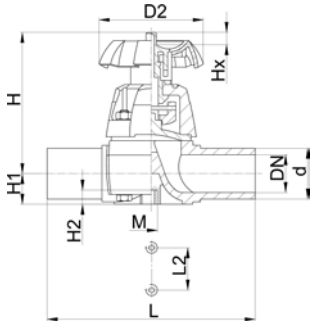

d [mm]	DN [mm]	PN	kv-value ($\Delta p=1$ bar) [l/min]	FPM Code	kg
20	15	10	72	167 315 592	0.260
25	20	10	137	167 315 593	0.382
32	25	10	207	167 315 594	0.660
40	32	10	354	167 315 595	0.779
50	40	10	517	167 315 596	1.137
63	50	10	713	167 315 597	2.061

d [mm]	D2 [mm]	H [mm]	H1 [mm]	H2 [mm]	L [mm]	L2 [mm]	M	Lift = Hx [mm]
20	80	90	14	12	124	25	M6	7
25	80	101	18	12	144	25	M6	10
32	94	117	22	12	154	25	M6	12
40	117	127	26	15	174	45	M8	16
50	117	139	32	15	194	45	M8	19
63	152	172	39	15	223	45	M8	27

Spare parts for diaphragm valve type 315 PP-H

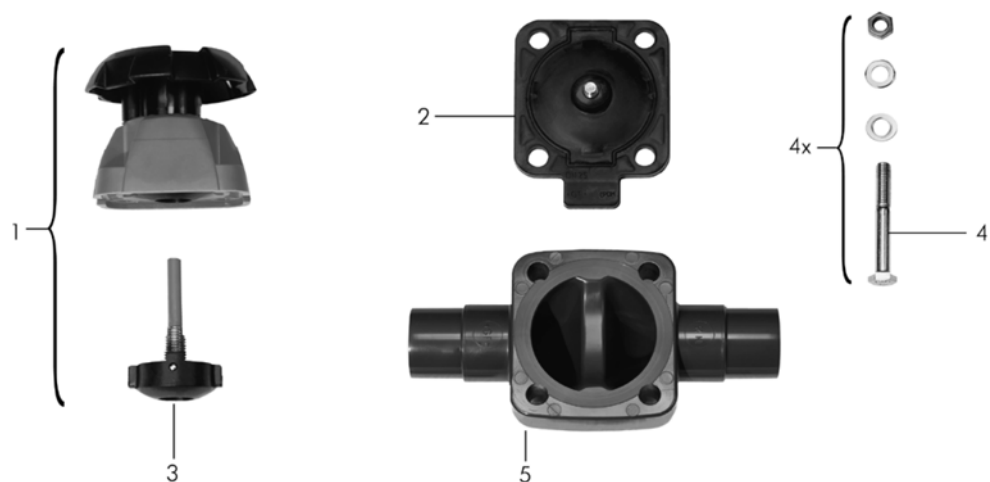

No.	Article / Material	Pieces	d20 DN 15	d25 DN 20	d32 DN 25	d40 DN 32	d50 DN 40	d63 DN 50
1	Bonnet complete (without diaphragm) elastomer diaphragm	1	161 484 625	161 484 626	161 484 627	161 484 628	161 484 629	161 484 630
2	Diaphragm NBR	1	161 311 710	161 311 711	161 311 712	161 311 713	161 311 714	161 311 715
2	Diaphragm EPDM	1	161 481 022	161 481 023	161 481 024	161 481 025	161 481 026	161 481 027
2	Diaphragm FPM	1	161 484 152	161 484 153	161 484 154	161 484 155	161 484 156	161 484 157
2	Diaphragm PTFE/EPDM	1	161 311 698	161 311 699	161 311 700	161 311 701	161 311 702	161 311 703
2	Diaphragm PTFE/FPM	1	161 481 926	161 481 927	161 481 928	161 481 929	161 481 930	161 481 931
2	Diaphragm CSM	1	161 311 728	161 311 729	161 311 730	161 311 731	161 311 732	1613117233
3	Pressure spindle elastomer diaphragm	1	161 484 688	161 484 689	161 484 690	161 484 691	161 484 692	161 484 693
4	Fastening set Stainless steel	1	161 484 704	161 484 705	161 484 706	161 484 707	161 484 708	161 484 709
5	Valve body with socket fusion spigot PP-H	1	167 480 328	167 480 329	167 480 330	167 480 331	167 480 332	167 480 333

Diaphragm Valves 317

Diaphragm valve type 317 PP-H With backing flanges PP-steel metric

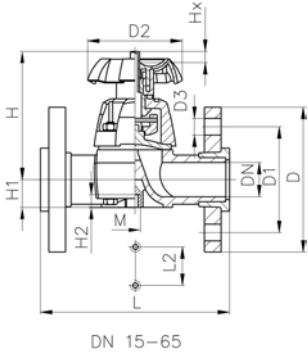

Model:

- Jointing faces flat/serrated
- Overall length according to EN 558-1
- Connecting dimensions: ISO 7005 / EN 1092 / DIN 2501 PN10 / BS4504

Option:

- Handwheel lockable DN15-65 (basic version not lockable)

d [mm]	DN [mm]	Inch	PN	kv-value ($\Delta p=1$ bar) [l/min]	PTFE with EPDM supporting diaphragm Code	kg
20	15	½	10	72	167 317 272	0.810
25	20	¾	10	137	167 317 273	1.200
32	25	1	10	207	167 317 274	1.850
40	32	1 ¼	10	354	167 317 275	2.410
50	40	1 ½	10	517	167 317 276	3.500
63	50	2	10	713	167 317 277	5.000
75	65	2 ½	10	992	167 317 278	7.040

d [mm]	D [mm]	D1 [mm]	D2 [mm]	D3 [mm]	L [mm]	L2 [mm]	H [mm]	H1 [mm]	H2 [mm]	M	AL	Lift = Hx [mm]
20	95	65	80	14	130	25	90	14	12	M6	4	7
25	105	75	80	14	150	25	101	18	12	M6	4	10
32	115	85	94	14	160	25	117	22	12	M8	4	12
40	140	100	117	18	180	45	127	26	15	M8	4	16
50	150	110	117	18	200	45	139	32	15	M10	4	19
63	165	125	152	18	230	45	172	39	15	M8	4	27
75	185	145	152	18	290	70	210	46	15	M8	4	35



Diaphragm valve type 317 PP-H With backing flanges PP-V metric

Model:

- Jointing faces flat/serrated
- Overall length according to EN 558-1
- Connecting dimensions: ISO 7005 / EN 1092 / DIN 2501 PN10 / BS4504
- DN 15-65 with backing flange
- DN 80-150 with fixed flange

Option:

- Handwheel lockable DN15-65 (basic version not lockable)

* With PP fixed flanges, jointing faces flat

* DN80 and DN150 fixed flanges metric and Inch ANSI B16.5

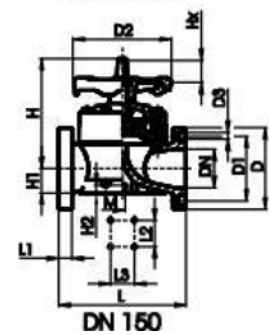
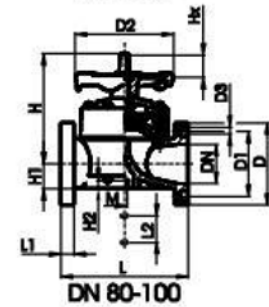
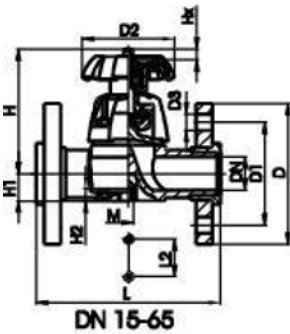

d [mm]	DN [mm]	Inch	PN	kv-value ($\Delta p=1$ bar) [l/min]	NBR Code	EPDM Code	CSM Code
20	15	½	10	72	167 317 152	167 317 167	167 317 197
25	20	¾	10	137	167 317 153	167 317 168	167 317 198
32	25	1	10	207	167 317 154	167 317 169	167 317 199
40	32	1 ¼	10	354	167 317 155	167 317 170	167 317 200
50	40	1 ½	10	517	167 317 156	167 317 171	167 317 201
63	50	2	10	713	167 317 157	167 317 172	167 317 202
75	65	2 ½	10	992	167 317 158	167 317 173	167 317 203
*90	80	3	10	1700	167 317 009	-	167 317 054
*110	100	4	10	2700	167 317 010	167 317 025	167 317 055

d [mm]	DN [mm]	Inch	PN	kv-value ($\Delta p=1$ bar) [l/min]	PTFE with EPDM supporting diaphragm Code	kg
20	15	½	10	72	167 317 182	0.532
25	20	¾	10	137	167 317 183	0.844
32	25	1	10	207	167 317 184	1.236
40	32	1 ¼	10	354	167 317 185	1.446
50	40	1 ½	10	517	167 317 186	2.456
63	50	2	10	713	167 317 187	3.664
75	65	2 ½	10	992	167 317 188	5.480
*90	80	3	10	1700	167 317 039	8.600
*110	100	4	10	2700	167 317 040	11.360

d [mm]	D [mm]	D1 [mm]	D2 [mm]	D3 [mm]	L [mm]	L1 [mm]	L2 [mm]	L3 [mm]	H [mm]	H1 [mm]	H2 [mm]	M	AL	Lift = Hx [mm]
20	95	65	80	14	130		25		90	14	12	M6	4	7
25	105	75	80	14	150		25		101	18	12	M6	4	10
32	115	85	94	14	160		25		117	22	12	M6	4	12
40	140	100	117	18	180		45		127	26	15	M8	4	16
50	150	110	117	18	200		45		139	32	15	M8	4	19
63	165	125	152	18	230		45		172	39	15	M8	4	27
75	185	145	152	18	290		70		210	46	15	M8	4	35
*90	200	160	270	18	310	35	120		265	57	23	M12	8	40
*110	225	180	270	18	350	38	120		304	69	23	M12	8	50

Spare parts for diaphragm valve type 317 (DN15-65) PP-H

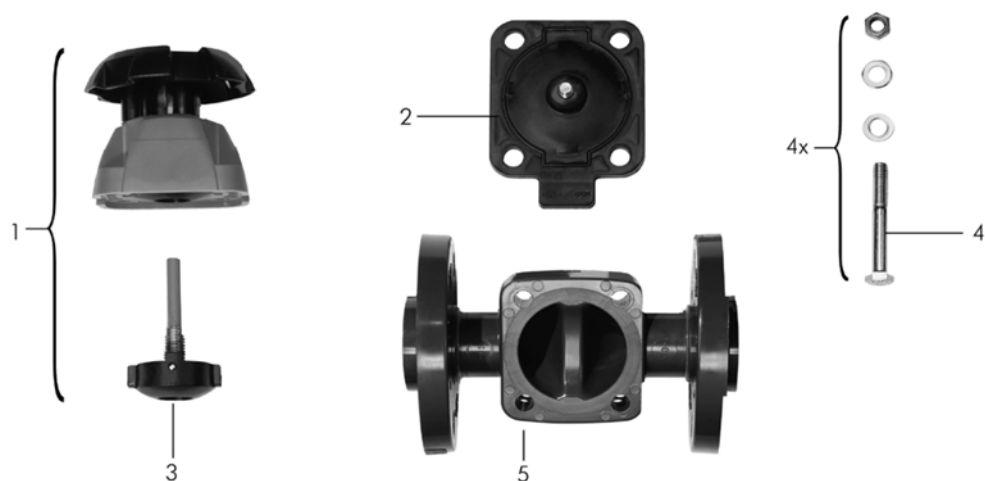

No.	Article / Material	Pieces	d20 DN 15	d25 DN 20	d32 DN 25	d40 DN 32	d50 DN 40	d63 DN 50	d75 DN 65
1	Bonnet complete (without diaphragm) PTFE diaphragm	1	161 484 632	161 484 633	161 484 634	161 484 635	161 484 636	161 484 637	161 484 638
2	Diaphragm NBR	1	161 311 710	161 311 711	161 311 712	161 311 713	161 311 714	161 311 715	161 480 241
2	Diaphragm EPDM	1	161 481 022	161 481 023	161 481 024	161 481 025	161 481 026	161 481 027	161 481 028
2	Diaphragm FPM	1	161 484 152	161 484 153	161 484 154	161 484 155	161 484 156	161 484 157	161 484 158
2	Diaphragm PTFE/EPDM	1	161 311 698	161 311 699	161 311 700	161 311 701	161 311 702	161 311 703	161 311 704
2	Diaphragm PTFE/FPM	1	161 481 926	161 481 927	161 481 928	161 481 929	161 481 930	161 481 931	161 481 932
2	Diaphragm CSM	1	161 311 728	161 311 729	161 311 730	161 311 731	161 311 732	161 311 733	161 311 734
3	Pressure spindel PTFE diaphragm	1	161 484 696	161 484 697	161 484 698	161 484 699	161 484 700	161 484 701	161 484 702
4	Fastening set Stainless steel	1	161 484 704	161 484 705	161 484 706	161 484 707	161 484 708	161 484 709	161 484 710
5	Valve body PP-H backing flange metric	1	167 484 025	167 484 026	167 484 027	167 484 028	167 484 029	167 484 030	167 484 031

Spare parts for diaphragm valve type 317 (DN80-150) PP-H

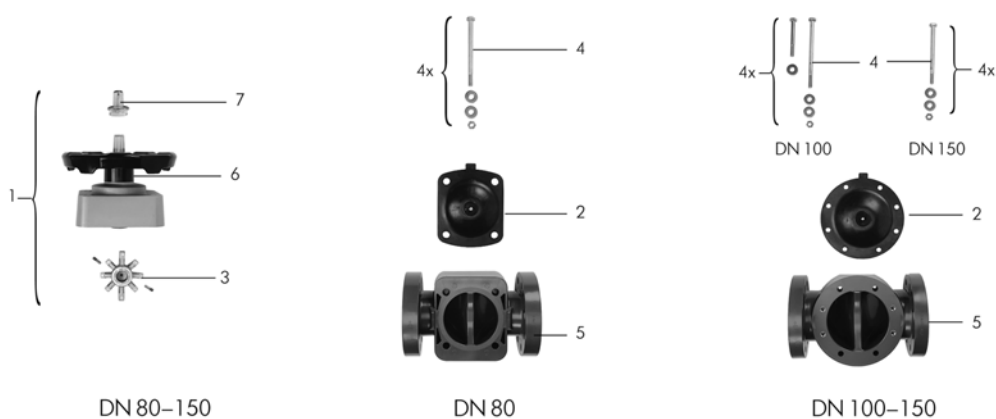

No.	Article / Material	Pieces	d90 DN 80	d110 DN 100	DN 150
1	Bonnet complete (without diaphragm) PTFE diaphragm	1	161 482 516	161 482 517	161 482 906
2	Diaphragm NBR	1	161 480 232	161 480 233	161 482 751
2	Diaphragm EPDM	1	161 481 029	161 481 030	161 482 754
2	Diaphragm FPM	1	161 484 159	161 484 160	161 484 226
2	Diaphragm PTFE/EPDM	1	161 480 241	161 480 242	161 482 760
2	Diaphragm CSM	1	161 480 238	161 480 239	161 480 757
3	Pressure spindel PTFE diaphragm	1	161 483 020	161 483 021	161 483 023
4	Fastening set Stainless steel	1	161 483 033	161 483 034	161 483 037
5	Valve body with PP-fixed flange metric PP-H	1	167 480 427	167 480 428	167 480 577
6	O-ring seal NBR	1	745 410 107	745 410 107	-
6	O-ring seal EPDM	1	-	-	748 410 212
7	Covering cap PVC-U SAN	1	161 481 759	161 481 759	161 482 744

Diaphragm Valves 319

Diaphragm valve type 319 PP-H With butt fusion spigots SDR11

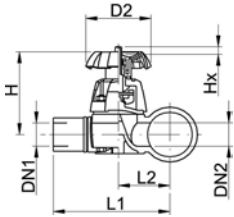
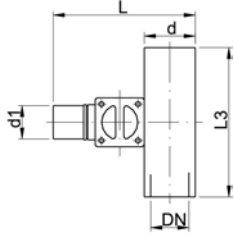

Model:

- Valve body injection molded, compact design
- Minimized static zone (dead leg)

Option:

- Handwheel with built in locking mechanism

d [mm]	d1 [mm]	DN [mm]	DN1 [mm]	DN2 [mm]	PN	kv-value ($\Delta p=1$ bar) [l/min]	PTFE with EPDM supporting diaphragm Code	kg
20	20	15	15	15	10	47	167 319 301	0.329
25	20	20	15	20	10	69	167 319 303	0.457
25	25	20	20	20	10	91	167 319 304	0.457
32	20	25	15	25	10	86	167 319 307	0.619
32	25	25	20	25	10	126	167 319 308	0.618
32	32	25	25	25	10	156	167 319 309	0.618
40	20	32	15	25	10	84	167 319 312	0.658
50	20	40	15	25	10	82	167 319 318	0.701
50	25	40	20	25	10	124	167 319 319	0.701
50	32	40	25	25	10	159	167 319 320	0.700
63	20	50	15	25	10	81	167 319 325	0.769
63	25	50	20	25	10	115	167 319 326	0.771
63	32	50	25	25	10	156	167 319 327	0.768
90	20	80	15	20	6	88	167 319 341	0.871
90	25	80	20	25	6	133	167 319 342	1.062
90	32	80	25	25	6	162	167 319 343	0.907
90	50	80	40	50	6	504	167 319 345	2.285
90	63	80	50	50	6	530	167 319 346	2.285
110	20	100	15	25	6	89	167 319 351	0.888
110	25	100	20	25	6	123	167 319 352	0.887
110	32	100	25	25	6	159	167 319 353	0.886
110	50	100	40	50	6	503	167 319 355	2.400
110	63	100	50	50	6	543	167 319 356	2.426

d [mm]	D2 [mm]	H [mm]	L [mm]	L1 [mm]	L2 [mm]	L3 [mm]
20	80	83	106	96	30	140
25	80	91	121	108	36	150
25	80	91	121	108	36	150
32	94	105	137	120	43	160
32	94	105	137	120	43	160
32	94	105	137	120	43	160
40	94	105	149	128	51	180
50	94	105	159	134	57	180
50	94	105	159	134	57	180
50	94	105	159	134	57	180
63	94	105	175	144	67	180
63	94	105	175	144	67	180
63	94	105	175	144	67	180
90	94	105	204	159	82	160
90	94	105	204	159	82	160
90	94	105	204	159	82	160
90	152	151	252	207	95	220
90	152	151	252	207	95	220
110	94	105	226	171	94	160
110	94	105	226	171	94	160
110	94	105	226	171	94	160
110	152	151	274	219	107	220
110	152	151	274	219	107	220

Spare parts for diaphragm valve type 319 PP-H

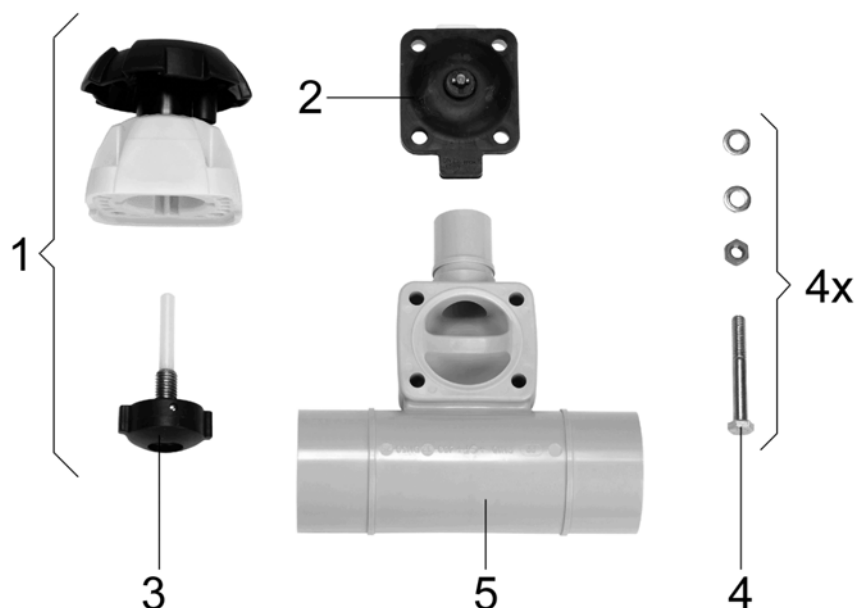

No.	Article / Material	Pieces	20x20	25x20	25x25	32x20	32x25	32x32	40x20
1	Bonnet complete (without diaphragm) PTFE diaphragm	1	161 484 632	161 484 633	161 484 633	161 484 634	161 484 634	161 484 634	161 484 634
2	Diaphragm NBR	1	161 311 710	161 311 711	161 311 711	161 311 712	161 311 712	161 311 712	161 311 712
2	Diaphragm EPDM	1	161 481 022	161 481 023	161 481 023	161 481 024	161 481 024	161 481 024	161 481 024
2	Diaphragm FPM	1	161 484 152	161 484 153	161 484 153	161 484 154	161 484 154	161 484 154	161 484 154
2	Diaphragm PTFE/EPDM	1	161 311 698	161 311 699	161 311 699	161 311 700	161 311 700	161 311 700	161 311 700
2	Diaphragm PTFE/FPM	1	161 481 926	161 481 927	161 481 927	161 481 928	161 481 928	161 481 928	161 481 928
2	Diaphragm CSM	1	161 311 728	161 311 729	161 311 729	161 311 730	161 311 730	161 311 730	161 311 730
3	Pressure spindel PTFE diaphragm	1	161 484 696	161 484 697	161 484 697	161 484 698	161 484 698	161 484 698	161 484 698
4	Fastening set Stainless steel	1	161 484 704	161 484 705	161 484 705	161 484 706	161 484 706	161 484 706	161 484 706
5	Valve body with butt fusion spigot PP-natur	1	168 480 177	168 480 179	168 480 180	168 480 182	168 480 183	168 480 184	168 480 186

No.	Article / Material	Pieces	50x20	50x25	50x32	63x20	63x25	63x32
1	Bonnet complete (without diaphragm) PTFE diaphragm	1	161 484 634	161 484 634	161 484 634	161 484 634	161 484 634	161 484 634
2	Diaphragm NBR	1	161 311 712	161 311 712	161 311 712	161 311 712	161 311 712	161 311 712
2	Diaphragm EPDM	1	161 481 024	161 481 024	161 481 024	161 481 024	161 481 024	161 481 024
2	Diaphragm FPM	1	161 484 154	161 484 154	161 484 154	161 484 154	161 484 154	161 484 154
2	Diaphragm PTFE/EPDM	1	161 311 700	161 311 700	161 311 700	161 311 700	161 311 700	161 311 700
2	Diaphragm PTFE/FPM	1	161 481 928	161 481 928	161 481 928	161 481 928	161 481 928	161 481 928
2	Diaphragm CSM	1	161 311 730	161 311 730	161 311 730	161 311 730	161 311 730	161 311 730
3	Pressure spindel PTFE diaphragm	1	161 484 698	161 484 698	161 484 698	161 484 698	161 484 698	161 484 698

No.	Article / Material	Pieces	50x20	50x25	50x32	63x20	63x25	63x32
4	Fastening set Stainless steel	1	161 484 706	161 484 706	161 484 706	161 484 706	161 484 706	161 484 706
5	Valve body with butt fusion spigot PP-natur	1	168 480 191	168 480 192	168 480 193	168 480 197	168 480 198	168 480 199

Butterfly valves

Butterfly valve type 567 PP-H Hand lever with ratchet settings



Model:

- Connecting dimension: ISO 7005 PN 10, EN 1092 PN 10, DIN 2501 PN 10, ANSI B 16.5 Class 150, BS 1560: 1989, BS 4504, JIS B 2220
- Overall length according to EN 558-1, ISO 5752

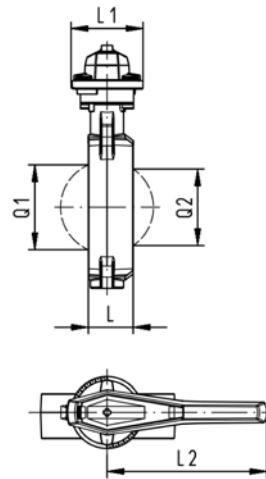
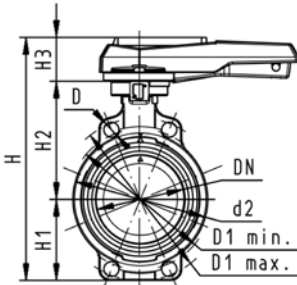

d [mm]	DN [mm]	Inch	PN	kv-value ($\Delta p=1$ bar) [l/min]	EPDM Code	FPM Code	kg
63	50	2	10	1470	167 567 002	167 567 022	0.969
75	65	2 ½	10	2200	167 567 003	167 567 023	1.061
90	80	3	10	3000	167 567 004	167 567 024	1.191
110	100	4	10	6500	167 567 005	167 567 025	1.751
140	125	5	10	11500	167 567 006	167 567 026	2.199
160	150	6	10	16600	167 567 007	167 567 027	2.989
225	200	8	10	39600	167 567 008	167 567 028	4.706

d [mm]	D [mm]	D1 min. [mm]	D1 max. [mm]	d2 [mm]	H [mm]	H1 [mm]	H2 [mm]	H3 [mm]	L [mm]	L1 [mm]	L2 [mm]	Q1 [mm]	Q2 [mm]
63	19	120.0	125.0	104	264	77	134	54	45	106	205	40	
75	19	139.7	145.0	115	277	83	140	54	46	106	205	54	35
90	19	150.0	160.0	131	289	89	146	54	49	106	205	67	50
110	19	175.0	190.5	161	325	104	167	55	56	106	255	88	74
140	23	210.0	215.9	187	352	117	181	55	64	106	255	113	97
160	24	241.3	241.3	215	373	130	189	55	72	106	255	139	123
225	23	290.0	295.0	267	435	158	210	67	73	140	408	178	169



Butterfly valve type 567 PP-H Reduction gear with handwheel



Model:

- Connecting dimension: ISO 7005 PN 10, EN 1092 PN 10, DIN 2501 PN 10, ANSI B 16.5 Class 150, BS 1560: 1989, BS 4504, JIS B 2220
- Overall length according to EN 558-1, ISO 5752

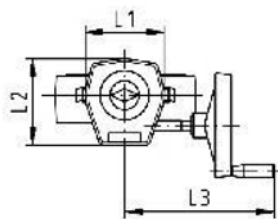
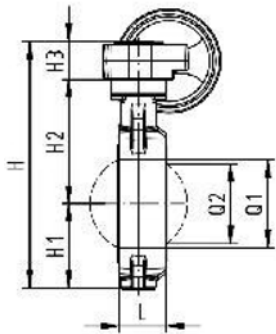
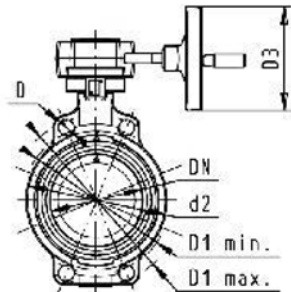

d [mm]	DN [mm]	Inch	PN	kv-value ($\Delta p=1$ bar) [l/min]	EPDM Code	FPM Code	kg
63	50	2	10	1470	167 567 042	167 567 062	3.007
75	65	2 ½	10	2200	167 567 043	167 567 063	3.099
90	80	3	10	3000	167 567 044	167 567 064	3.229
110	100	4	10	6500	167 567 045	167 567 065	3.741
140	125	5	10	11500	167 567 046	167 567 066	4.189
160	150	6	10	16600	167 567 047	167 567 067	4.979
225	200	8	10	39600	167 567 048	167 567 068	6.159

d [mm]	D [mm]	D1 min. [mm]	D1 max. [mm]	d2 [mm]	D3 [mm]	H [mm]	H1 [mm]	H2 [mm]	H3 [mm]	L [mm]	L1 [mm]	L2 [mm]	L3 [mm]	Q1 [mm]
63	19	120.0	125.0	104	160	278	77	134	68	45	120	132	236	40
75	19	139.7	145.0	115	160	291	83	140	68	46	120	132	236	54
90	19	150.0	160.0	131	160	303	89	146	68	49	120	132	236	67
110	19	175.0	190.5	160	160	339	104	167	68	56	120	132	236	88
140	23	210.0	215.9	187	160	365	117	181	68	64	120	132	236	113
160	24	241.3	241.3	215	160	387	130	189	68	72	120	132	236	139
225	23	290.0	295.0	267	160	436	158	210	68	73	120	132	236	178

d [mm]	Q2 [mm]
63	
75	35
90	50
110	74
140	97
160	123
225	169



Butterfly valve type 567 PP-H Bare shaft



Model:

- Connecting dimension: ISO 7005 PN 10, EN 1092 PN 10, DIN 2501 PN 10, ANSI B 16.5 Class 150, BS 1560: 1989, BS 4504, JIS B 2220
- Overall length according to EN 558-1, ISO 5752
- Interface F07 according to DIN/ISO 5211

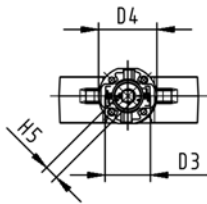
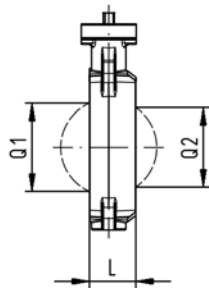
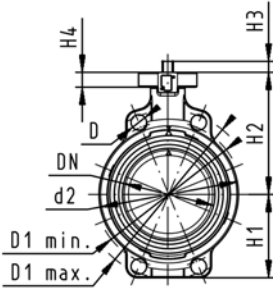

d [mm]	DN [mm]	Inch	PN	kv-value ($\Delta p=1$ bar) [l/min]	EPDM Code	FPM Code	kg
63	50	2	10	1470	167 567 802	167 567 822	0.747
75	65	2 1/2	10	2200	167 567 803	167 567 823	0.839
90	80	3	10	3000	167 567 804	167 567 824	0.969
110	100	4	10	6500	167 567 805	167 567 825	1.481
140	125	5	10	11500	167 567 806	167 567 826	1.929
160	150	6	10	16600	167 567 807	167 567 827	2.719
225	200	8	10	39600	167 567 808	167 567 828	3.899

d [mm]	D [mm]	D1 min. [mm]	D1 max. [mm]	d2 [mm]	D3 [mm]	D4 [mm]	H [mm]	H1 [mm]	H2 [mm]	H3 [mm]	H4 [mm]	H5 [mm]	L [mm]	Q1 [mm]
63	19	120.0	125.0	104	70	90	222	77	134	27	23	11	45	40
75	19	139.7	145.0	115	70	90	235	83	140	27	23	11	46	54
90	19	150.0	160.0	131	70	90	247	89	146	27	23	11	49	67
110	19	175.0	190.5	161	70	90	287	104	167	16	23	14	56	88
140	23	210.0	215.9	187	70	90	313	117	181	16	23	14	64	113
160	24	241.3	241.3	215	70	90	335	130	189	19	23	17	72	139
225	23	290.0	295.0	267	70	90	387	158	210	19	23	17	73	178

d [mm]	Q2 [mm]
63	
75	35
90	50
110	74
140	97
160	123
225	169



Lugstyle butterfly valve type 568 PP-H Hand lever with ratchet settings



Model:

- Outer body in GGG-40.3 epoxy-coated
- Connecting dimension: ISO 7005 PN10, EN 1092 PN 10, DIN 2501 PN10
- Overall length according to EN 558-1, ISO 5752

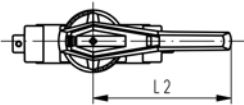
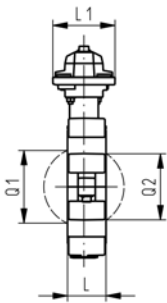
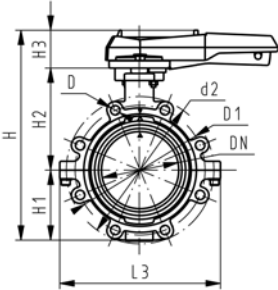

d [mm]	DN [mm]	Inch	PN	kv-value ($\Delta p=1$ bar) [l/min]	EPDM Code	FPM Code
63	50	2	10	1470	167 568 002	167 568 022
75	65	2 ½	10	2200	167 568 003	167 568 023
90	80	3	10	3000	167 568 004	167 568 024
110	100	4	10	6500	167 568 005	167 568 025
140	125	5	10	11500	167 568 006	167 568 026
160	150	6	10	16600	167 568 007	167 568 027
225	200	8	10	39600	167 568 008	167 568 028

d [mm]	d2 [mm]	D	D1 [mm]	H [mm]	H1 [mm]	H2 [mm]	H3 [mm]	L [mm]	L1 [mm]	L2 [mm]	L3 [mm]	Q1 [mm]	Q2 [mm]
63	150	M16	125	265	77	134	54	45	106	205	150	40	
75	170	M16	145	277	83	140	54	46	106	205	160	54	35
90	184	M16	160	289	89	146	54	49	106	205	205	67	50
110	216	M16	180	326	104	167	55	56	106	255	244	88	74
140	246	M16	210	353	117	181	55	64	106	255	272	113	97
160	273	M20	240	374	130	189	55	72	106	255	297	139	123
225	334	M20	295	435	158	210	67	73	140	408	360	178	169

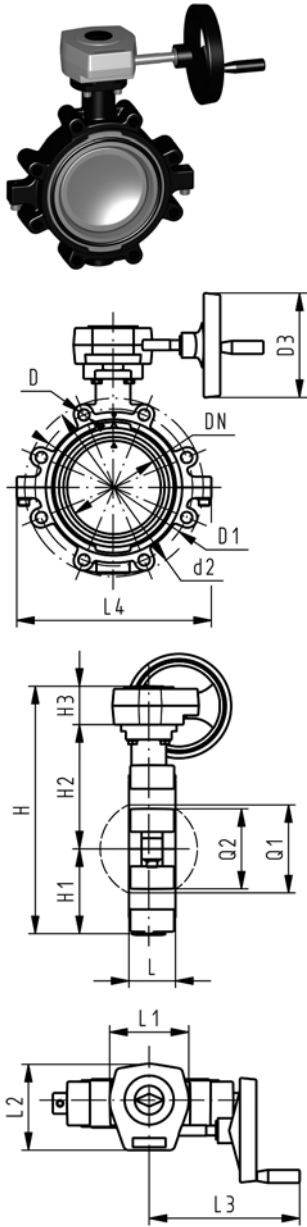

Lugstyle butterfly valve type 568 PP-H Reduction gear with handwheel



Model:

- Outer body in GGG-40.3 epoxy-coated
- Connecting dimension: ISO 7005 PN10, EN 1092 PN 10, DIN 2501 PN10
- Overall length according to EN 558-1, ISO 5752

d [mm]	DN [mm]	Inch	PN	kv-value ($\Delta p=1$ bar) [l/min]	EPDM Code	FPM Code									
63	50	2	10	1470	167 568 042	167 568 062									
75	65	2 ½	10	2200	167 568 043	167 568 063									
90	80	3	10	3000	167 568 044	167 568 064									
110	100	4	10	6500	167 568 045	167 568 065									
140	125	5	10	11500	167 568 046	167 568 066									
160	150	6	10	16600	167 568 047	167 568 067									
225	200	8	10	39600	167 568 048	167 568 068									

d [mm]	d2 [mm]	D	D1 [mm]	D3 [mm]	H [mm]	H1 [mm]	H2 [mm]	H3 [mm]	L [mm]	L1 [mm]	L2 [mm]	L3 [mm]	L4 [mm]	Q1 [mm]	Q2 [mm]
63	150	M16	125	160	279	77	134	68	45	120	132	236	150	40	
75	170	M16	145	160	291	83	140	68	46	120	132	236	160	54	35
90	184	M16	160	160	303	89	146	68	49	120	132	236	205	67	50
110	216	M16	180	160	339	104	167	68	56	120	132	236	244	88	74
140	246	M16	210	160	366	117	181	68	64	120	132	236	272	113	97
160	273	M20	240	160	387	130	189	68	72	120	132	236	297	139	123
225	334	M20	295	160	436	158	210	68	73	120	132	236	360	178	169



Lugstyle butterfly valve type 568 PP-H Bare shaft



Model:

- Outer body in GGG-40.3 epoxy-coated
- Connecting dimension: ISO 7005 PN 10, EN 1092 PN 10, DIN 2501 PN 10, BS 4504 PN 10
- Overall length according to EN 558-1, ISO 5752
- Interface F07 according to DIN/ISO 5211

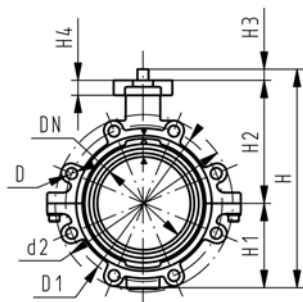

d [mm]	DN [mm]	Inch	PN	kv-value ($\Delta p=1$ bar) [l/min]	EPDM Code	FPM Code
63	50	2	10	1470	167 568 802	167 568 822
75	65	2 ½	10	2200	167 568 803	167 568 823
90	80	3	10	3000	167 568 804	167 568 824
110	100	4	10	6500	167 568 805	167 568 825
140	125	5	10	11500	167 568 806	167 568 826
160	150	6	10	16600	167 568 807	167 568 827
225	200	8	10	39600	167 568 808	167 568 828

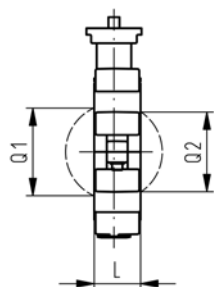

d [mm]	d2 [mm]	D	D1 [mm]	D3 [mm]	D4 [mm]	H [mm]	H1 [mm]	H2 [mm]	H3 [mm]	H4 [mm]	L [mm]	Q1 [mm]	Q2 [mm]
63	150	M16	125	70	90	222	77	134	27	23	45	40	
75	170	M16	145	70	90	235	83	140	27	23	46	54	35
90	184	M16	160	70	90	247	89	146	27	23	49	67	50
110	216	M16	180	70	90	287	104	167	16	23	56	88	74
140	246	M16	210	70	90	313	117	181	16	23	64	113	97
160	273	M20	240	70	90	335	130	189	19	23	72	139	123
225	334	M20	295	70	90	387	158	210	19	23	73	178	169

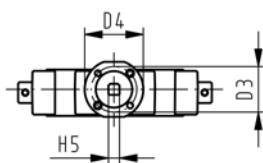



Lugstyle butterfly valve type 568 PP-H Hand lever with ratchet settings



Model:

- Outer body in GGG-40.3 epoxy-coated
- Connecting dimension ANSI B 16.5 Class 150
- Overall length according to EN 558-1, ISO 5752

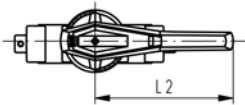
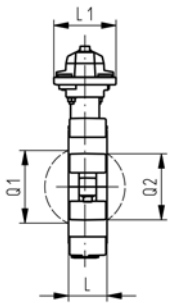
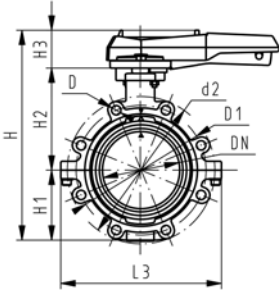

Inch	d [mm]	DN [mm]	PN	kv-value ($\Delta p=1$ bar) [l/min]	EPDM Code	FPM Code
2	63	50	10	1470	167 568 102	167 568 122
2 ½	75	65	10	2200	167 568 103	167 568 123
3	90	80	10	3000	167 568 104	167 568 124
4	110	100	10	6500	167 568 105	167 568 125
5	140	125	10	11500	167 568 106	167 568 126
6	160	150	10	16600	167 568 107	167 568 127
8	225	200	10	39600	167 568 108	167 568 128

Inch	d2 [mm]	D	D1 [mm]	H [mm]	H1 [mm]	H2 [mm]	H3 [mm]	L [mm]	L1 [mm]	L2 [mm]	L3 [mm]	Q1 [mm]	Q2 [mm]
2	150	UNC 5/8	121	265	77	134	54	45	106	205	150	40	
2 ½	170	UNC 5/8	138	277	83	140	54	46	106	205	160	54	35
3	177	UNC 5/8	152	289	89	146	54	49	106	205	175	67	50
4	216	UNC 5/8	191	326	104	167	55	56	106	255	244	88	74
5	246	UNC 3/4	216	353	117	181	55	64	106	255	272	113	97
6	273	UNC 3/4	241	374	130	189	55	72	106	255	297	139	123
8	334	UNC 3/4	298	435	158	210	67	73	140	408	360	178	169



Lugstyle butterfly valve type 568 PP-H Reduction gear with handwheel



Model:

- Outer body in GGG-40.3 epoxy-coated
- Connecting dimension ANSI B 16.5 Class 150
- Overall length according to EN 558-1, ISO 5752

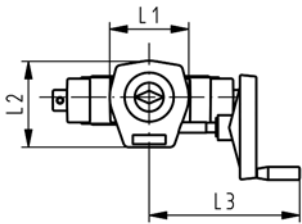
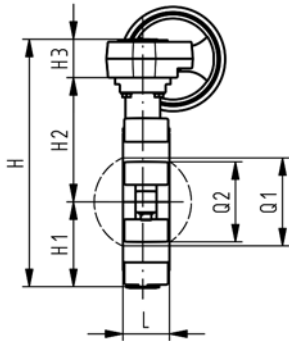
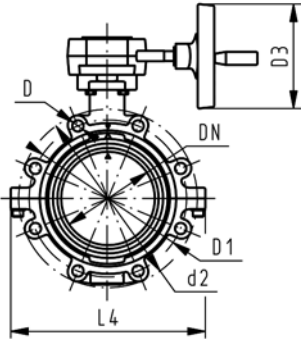

Inch	d [mm]	DN [mm]	PN	kv-value ($\Delta p=1$ bar) [l/min]	EPDM Code	FPM Code
2	63	50	10	1470	167 568 142	167 568 162
2 ½	75	65	10	2200	167 568 143	167 568 163
3	90	80	10	3000	167 568 144	167 568 164
4	110	100	10	6500	167 568 145	167 568 165
5	140	125	10	11500	167 568 146	167 568 166
6	160	150	10	16600	167 568 147	167 568 167
8	225	200	10	39600	167 568 148	167 568 168

Inch	d2 [mm]	D	D1 [mm]	D3 [mm]	H [mm]	H1 [mm]	H2 [mm]	H3 [mm]	L [mm]	L1 [mm]	L2 [mm]	L3 [mm]	L4 [mm]	Q1 [mm]
2	150	UNC 5/8	121	160	279	77	134	68	45	120	132	236	150	40
2 ½	170	UNC 5/8	138	160	291	83	140	68	46	120	132	236	160	54
3	177	UNC 5/8	152	160	303	89	146	68	49	120	132	236	175	67
4	216	UNC 5/8	191	160	339	104	167	68	56	120	132	236	244	88
5	246	UNC 3/4	216	160	366	117	181	68	64	120	132	236	272	113
6	273	UNC 3/4	241	160	387	130	189	68	72	120	132	236	297	139
8	334	UNC 3/4	298	160	436	158	210	68	73	120	132	236	360	178

Inch	Q2 [mm]
2	
2 ½	35
3	50
4	74
5	97
6	123
8	169



Lugstyle butterfly valve type 568 PP-H Bare shaft



Model:

- Outer body in GGG-40.3 epoxy-coated
- Connecting dimension ANSI B 16.5 Class 150
- Overall length according to EN 558-1, ISO 5752
- Interface F07 according to DIN/ISO 5211

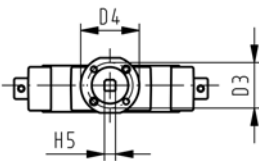
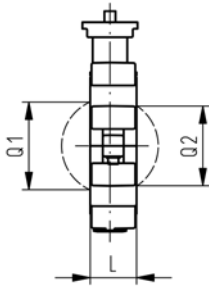
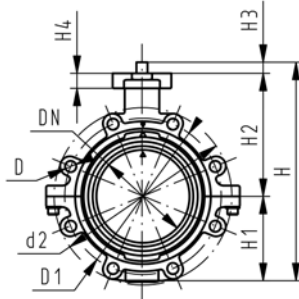

Inch	d [mm]	DN [mm]	PN	kv-value ($\Delta p=1$ bar) [l/min]	EPDM Code	FPM Code
2	63	50	10	1470	167 568 902	167 568 922
2 ½	75	65	10	2200	167 568 903	167 568 923
3	90	80	10	3000	167 568 904	167 568 924
4	110	100	10	6500	167 568 905	167 568 925
5	140	125	10	11500	167 568 906	167 568 926
6	160	150	10	16600	167 568 907	167 568 927
8	225	200	10	39600	167 568 908	167 568 928

Inch	d2 [mm]	D	D1 [mm]	D3 [mm]	D4 [mm]	H [mm]	H1 [mm]	H2 [mm]	H3 [mm]	H4 [mm]	L [mm]	Q1 [mm]	Q2 [mm]
2	150	UNC 5/8	121	70	90	222	77	134	27	23	45	40	
2 ½	170	UNC 5/8	138	70	90	235	83	140	27	23	46	54	35
3	177	UNC 5/8	152	70	90	247	89	146	27	23	49	67	50
4	216	UNC 5/8	191	70	90	287	104	167	16	23	56	88	74
5	246	UNC 3/4	216	70	90	313	117	181	16	23	64	113	97
6	273	UNC 3/4	241	70	90	335	130	189	19	23	72	139	123
8	334	UNC 3/4	298	70	90	387	158	210	19	23	73	178	169



Butterfly valve type 367 PP-H (DN250-DN300) Lever handle with ratchet settings

Model:

- Overall length ISO 7508
- Connecting dimensions: ISO 7005, EN 1092, BS 4504, DIN 2501; bolt circle PN 10
- Jointing face flat

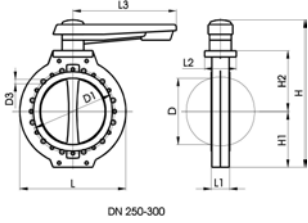

DN 250-300

d [mm]	DN [mm]	Inch	PN	kv-value ($\Delta p=1$ bar) [l/min]	EPDM Code	FPM Code	kg	
280	250	10	6	55200	167 367 011	167 367 031	12.000	
315	300	12	4	80000	167 367 012	167 367 032	17.365	

d [mm]	D [mm]	D1 [mm]	D3 [mm]	L [mm]	L1 [mm]	L2 [mm]	L3 [mm]	H [mm]	H1 [mm]	H2 [mm]	Conne- ction	
280	238	350	22	419	76	152	410	557	220	248	metric	
315	286	400	22	508	83	152	410	645	266	290	metric	



Butterfly valve type 367 PP-H (DN250-DN300) Reduction gear with handwheel

Model:

- Overall length ISO 7508
- Connecting dimensions: ISO 7005, EN 1092, BS 4504, DIN 2501; bolt circle PN 10
- Jointing face flat

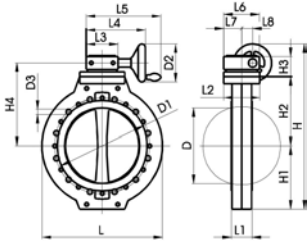

DN 250-300

d [mm]	DN [mm]	Inch	PN	kv-value ($\Delta p=1$ bar) [l/min]	EPDM Code	FPM Code	kg	
280	250	10	6	55200	167 367 091	167 367 111	17.700	
315	300	12	4	80000	167 367 092	167 367 112	27.150	

d [mm]	D [mm]	D1 [mm]	D2 [mm]	D3 [mm]	L [mm]	L1 [mm]	L2 [mm]	L3 [mm]	L4 [mm]	L5 [mm]	L6 [mm]	L7 [mm]	L8 [mm]	H [mm]	H1 [mm]
280	238	350	160	22	420	76	152	134	253	328	150	62	60	602	220
315	286	400	160	22	508	83	152	134	253	328	150	62	60	690	266

d [mm]	H2 [mm]	H3 [mm]	H4 [mm]	Conne- ction	
280	248	85	302	metric	
315	290	85	344	metric	

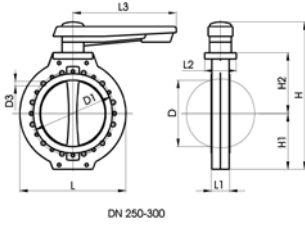

DN 250-300

Butterfly valve type 367 PP-H ANSI (DN250-DN300) Lever handle ratchet settings

Model:

- Overall length ISO 7508
- Connecting dimension: ANSI B 16.5 class 150 (ASTM D 4024), BS EN 1759
- Jointing faces serrated

Inch	DN [mm]	PN	kv-value ($\Delta p=1$ bar) [l/min]	EPDM Code	FPM Code	kg	
10	250	6	55200	167 367 131	167 367 151	12.000	
12	300	4	80000	167 367 132	167 367 152	17.365	

Inch	D [mm]	D1 [mm]	D3 [mm]	L [mm]	L1 [mm]	L2 [mm]	L3 [mm]	H [mm]	H1 [mm]	H2 [mm]	Conne- tion	
10	238	362	25	420	76	152	410	557	220	248	ANSI	
12	286	432	25	508	83	152	410	645	266	290	ANSI	

Tightening torque values for bolts, Type 367

Flanged joints with O-Ring or flange gaskets

d	DN	inch	Total amount of screws	Torque in Nm	
75	65	2 1/2	4xM16x140	25	
90	80	3	8xM16x150	25	
110	100	4	8xM16x160	30	
140	125	5	8xM16x180	35	
160	150	6	8xM20x200	40	
225	200	8	8xM20x220	50	

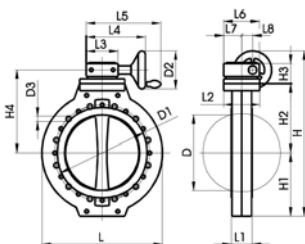

DN 250-300

Butterfly valve type 367 PP-H ANSI (DN250-DN300) Reduction gear with handwheel

Model:

- Overall length ISO 7508
- Connecting dimension: ANSI B 16.5 class 150 (ASTM D 4024), BS EN 1759
- Jointing faces serrated

Inch	DN [mm]	PN	kv-value ($\Delta p=1$ bar) [l/min]	EPDM Code	FPM Code	kg	
10	250	6	55200	167 367 251	167 367 271	12.400	
12	300	4	80000	167 367 252	167 367 272	27.150	

Inch	D [mm]	D1 [mm]	D2 [mm]	D3 [mm]	L [mm]	L1 [mm]	L2 [mm]	L3 [mm]	L4 [mm]	L5 [mm]	L6 [mm]	L7 [mm]	L8 [mm]	H [mm]	H1 [mm]
10	238	362	160	25	420	76	152	134	253	328	150	62	60	602	220
12	286	432	160	25	508	83	152	134	253	328	150	62	60	690	266

Inch	H2 [mm]	H3 [mm]	H4 [mm]	Conne- tion	
10	248	85	302	ANSI	
12	290	85	344	ANSI	

Spare parts for butterfly valves

Integrated position indicator Automatic AU



Size	DN-DN [mm]	Code	kg	
1	50 - 80	161 486 858	0.063	
2	100 - 125	161 486 304	0.063	
3	150 - 200	161 486 009	0.063	

Integrated position indicator Automatic AG NI



Size	DN-DN [mm]	Code	kg	
1	50 - 80	161 486 859	0.063	
2	100 - 125	161 486 305	0.063	
3	150 - 200	161 486 010	0.063	

Integrated position indicator Electric Namur



Size	DN-DN [mm]	Code	kg	
1	50 - 80	161 486 855	0.050	
2	100 - 125	161 486 301	0.050	
3	150 - 200	161 486 006	0.050	

Integrated position indicator Electric PNP



Size	DN-DN [mm]	Code	kg	
1	50 - 80	161 486 856	0.056	
2	100 - 125	161 486 302	0.056	
3	150 - 200	161 486 007	0.056	

Integrated position indicator Electric NPN



Size	DN-DN [mm]	Code	kg	
1	50 - 80	161 486 857	0.056	
2	100 - 125	161 486 303	0.056	
3	150 - 200	161 486 008	0.056	

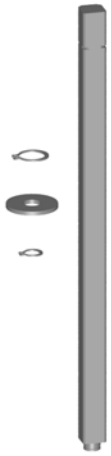

Shaft set to type 567/568
Chrom steel 1.4301 AISI 304
With retention ring and washer

d [mm]	DN [mm]	Code	kg
63	50	161 486 899	0.225
75	65	161 486 900	0.237
90	80	161 486 901	0.249
110	100	161 486 902	0.429
140	125	161 486 903	0.469
160	150	161 486 904	0.749
225	200	161 486 905	0.844



End stop to type 567/568
PP glasfiber reinforced

DN-DN [mm]	Code	kg
50 - 80	167 483 251	0.023
100 - 125	167 483 252	0.033
150 - 200	167 483 253	0.033

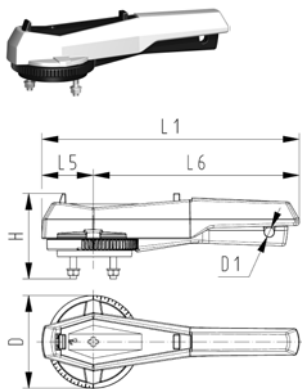

Hand lever with index plate to type 567/568

Size	d-d [mm]	DN-DN [mm]	Code	kg	D [mm]	D1 [mm]	L1 [mm]	L5 [mm]	L6 [mm]	H [mm]
1	75 - 90	50 - 80	161 486 690	0.480	115	12	270	64	206	105
2	110 - 140	100 - 125	161 486 691	0.480	115	12	320	64	256	107
2	- 160	- 150	161 486 694	0.540	115	12	320	64	256	107
3	- 225	- 200	161 486 695	0.540	148	10	510	102	408	116

Exchange kit for standard lever
To fine adjustment lever to type 567/568

Size	Code
1 + 2	161 486 950
3	161 486 951



Hand lever with fine adjustment to type 567/568

Size	DN-DN [mm]	Code	kg
1	50 - 80	161 486 325	0.485
2	100 - 125	161 486 326	0.540
2	- 150	161 486 327	0.537
3	- 200	161 486 328	1.375



PP-H
Bearing bushes to type 567/568
Assembled with o-ring
Suitable for PP-H and ABS

d-d [mm]	DN-DN [mm]	EPDM Code	FPM Code	kg	
63 - 90	50 - 80	167 484 259	167 484 265	0.021	
110 - 140	100 - 125	167 484 260	167 484 266	0.038	
160 - 225	150 - 200	167 484 261	167 484 267	0.081	



PP-H
Disc to type 567/568

d [mm]	DN [mm]	Code	kg	
63	50	167 483 226	0.023	
75	65	167 483 227	0.042	
90	80	167 483 228	0.067	
110	100	167 483 229	0.130	
140	125	167 483 230	0.233	
160	150	167 483 231	-	
225	200	167 483 232	-	



PP-H
Inner body to type 567/568
Assembled with profile seal

d [mm]	DN [mm]	EPDM Code	FPM Code	kg	
63	50	167 484 271	167 484 286	0.102	
75	65	167 484 272	167 484 287	0.124	
90	80	167 484 273	167 484 288	0.175	
110	100	167 484 274	167 484 289	0.314	
140	125	167 484 275	167 484 290	0.460	
160	150	167 484 276	167 484 291	0.570	
225	200	167 484 277	167 484 292	0.965	



PP-H Special flange adaptor PP-H S8,3/SDR17,6 Jointing face flat / serrated

Model:

- Conventional butt fusion according to DVS2207
- In connection with +GF+ butterfly valves, chamfered and ready for use

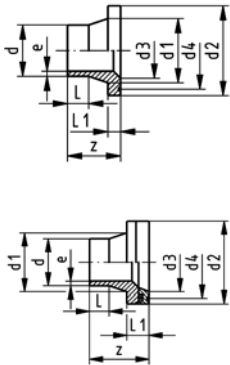

d [mm]	DN [mm]	Code	kg	D [mm]	D1 [mm]	L [mm]	L1 [mm]	L2 [mm]	e [mm]
63	50	727 798 536	0.100	75	102	50	14	18	3,6
75	65	727 798 412	0.202	89	122	80	16	43	4,3
90	80	727 798 413	0.274	105	138	80	17	41	5,1
110	100	727 798 414	0.358	125	158	80	18	40	6,3
140	125	727 798 541	0.499	155	188	80	18	34	8,0
160	150	727 798 842	0.770	175	212	92	18	41	9,1
225	200	727 798 845	1.350	235	268	100	24	44	12,8

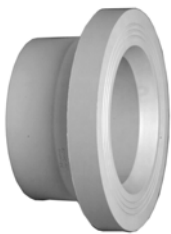

PP-H Special flange adaptor PP-H S5/SDR11 Jointing face flat / serrated

Model:

- Conventional butt fusion according to DVS2207
- In connection with +GF+ butterfly valves, chamfered and ready for use

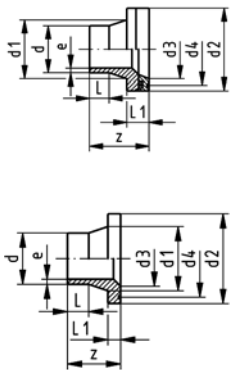

d [mm]	DN [mm]	Code	kg	D [mm]	D1 [mm]	D2 [mm]	L [mm]	L1 [mm]	L2 [mm]	e [mm]
75	65	727 798 812	0.210				43	16		6,8
90	80	727 798 813	0.210				28	17		8,2
110	100	727 798 814	0.440				28	18		10,0
140	125	727 798 816	0.800				37	25		12,7
160	150	727 798 817	0.900				41	25		14,6
225	200	727 798 820	1.700				36	32		20,5

Ball check valves

Ball check valve type 360 PP-H With fusion sockets metric

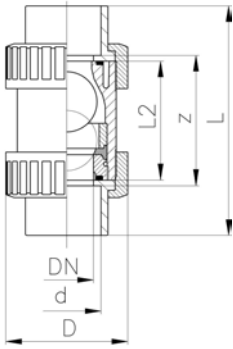

Model:

- For easy installation and removal
- The ball seals at a minimum water column of 2 m
- Vibration free even at high flow velocity

d [mm]	DN [mm]	PN	kv-value ($\Delta p=1$ bar) [l/min]	EPDM Code	FPM Code	kg	D [mm]	L [mm]	L2 [mm]	z [mm]
16	10	10	170	167 360 401	167 360 411	0.079	46	98	62	72
20	15	10	150	167 360 402	167 360 412	0.079	46	101	62	73
25	20	10	330	167 360 403	167 360 413	0.134	56	119	74	87
32	25	10	390	167 360 404	167 360 414	0.203	67	130	78	94
40	32	10	710	167 360 405	167 360 415	0.380	82	149	88	109
50	40	10	900	167 360 406	167 360 416	0.612	98	162	94	118
63	50	10	1390	167 360 407	167 360 417	1.116	120	195	113	143

Ball check valve type 360 PP-H With socket fusion spigots metric

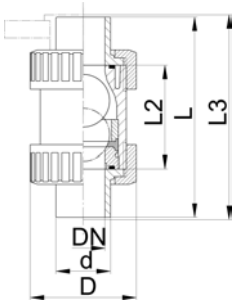

Model:

- For easy installation and removal
- The ball seals at a minimum water column of 2 m
- Vibration free even at high flow velocity

d [mm]	DN [mm]	PN	kv-value ($\Delta p=1$ bar) [l/min]	EPDM Code	FPM Code	kg	D [mm]	L [mm]	L2 [mm]
16	10	10	170	167 360 441	167 360 451	0.080	46	109	62
20	15	10	150	167 360 442	167 360 452	0.080	46	119	62
25	20	10	330	167 360 443	167 360 453	0.136	56	140	74
32	25	10	390	167 360 444	167 360 454	0.208	67	150	78
40	32	10	710	167 360 445	167 360 455	0.386	82	171	88
50	40	10	900	167 360 446	167 360 456	0.631	97	191	94
63	50	10	1390	167 360 447	167 360 457	1.149	119	220	113



Ball check valve type 360 PP-H With butt fusion spigots S8/SDR17

Model:

- For easy installation and removal
- The ball seals at a minimum water column of 2 m
- Vibration free even at high flow velocity

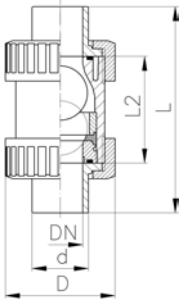

d [mm]	DN [mm]	PN	kv-value ($\Delta p=1$ bar) [l/min]	EPDM Code	FPM Code	kg	D [mm]	L [mm]	L2 [mm]
25	20	6	330	167 360 463	167 360 473	0.136	56	144	74
32	25	6	390	167 360 464	167 360 474	0.208	67	150	78
40	32	6	710	167 360 465	167 360 475	0.386	82	171	88
50	40	6	900	167 360 466	167 360 476	0.631	97	191	94
63	50	6	1390	167 360 467	167 360 477	1.149	119	220	113



Ball check valve type 360 PP-H With butt fusion spigots S5/SDR11

Model:

- For easy installation and removal
- The ball seals at a minimum water column of 2 m
- Vibration free even at high flow velocity

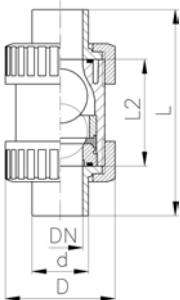

d [mm]	DN [mm]	PN	kv-value ($\Delta p=1$ bar) [l/min]	EPDM Code	FPM Code	kg	D [mm]	L [mm]	L2 [mm]
20	15	10	150	167 360 482	167 360 492	0.080	46	130	62
25	20	10	330	167 360 483	167 360 493	0.136	56	144	74
32	25	10	390	167 360 484	167 360 494	0.208	67	150	78
40	32	10	710	167 360 485	167 360 495	0.386	82	171	88
50	40	10	900	167 360 486	167 360 496	0.631	97	191	94
63	50	10	1390	167 360 487	167 360 497	1.149	119	220	113



Ball check valve type 360 PP-H With threaded sockets Rp

Model:

- For easy installation and removal
- The ball seals at a minimum water column of 2 m
- Vibration free even at high flow velocity
- Parallel female thread Rp

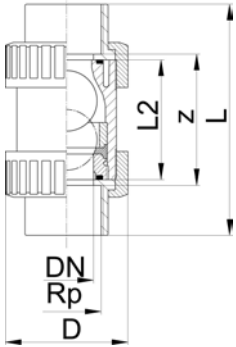

Rp [inch]	DN [mm]	PN	kv-value ($\Delta p=1$ bar) [l/min]	EPDM Code	FPM Code	kg	z [mm]	D [mm]	L [mm]	L2 [mm]
3/8	10	10	170	167 360 421	167 360 431	0.078	66	46	98	62
1/2	15	10	150	167 360 422	167 360 432	0.078	66	46	101	62
3/4	20	10	330	167 360 423	167 360 433	0.131	78	56	119	74
1	25	10	390	167 360 424	167 360 434	0.199	82	67	130	78
1 1/4	32	10	710	167 360 425	167 360 435	0.372	95	82	149	88
1 1/2	40	10	900	167 360 426	167 360 436	0.618	108	98	162	94
2	50	10	1390	167 360 427	167 360 437	1.129	134	120	195	113



Ball check valve type 360 PP-H With fixed flanges serrated metric

Model:

- For easy installation and removal
- The ball seals at a minimum water column of 2 m
- Vibration free even at high flow velocity
- Overall length EN 558-1
- Connecting dimensions: ISO 7005 / EN 1092 / DIN 2501 PN10 / BS4504

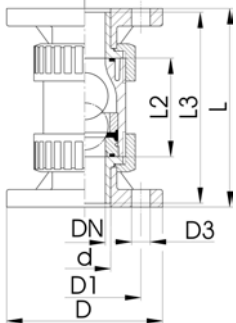

d [mm]	DN [mm]	Inch	PN	kv-value ($\Delta p=1$ bar) [l/min]	EPDM Code	FPM Code	kg
20	15	1/2	10	150	167 360 502	167 360 512	0.206
25	20	3/4	10	330	167 360 503	167 360 513	0.299
32	25	1	10	390	167 360 504	167 360 514	0.437
40	32	1 1/4	10	710	167 360 505	167 360 515	0.731
50	40	1 1/2	10	900	167 360 506	167 360 516	1.044
63	50	2	10	1390	167 360 507	167 360 517	1.711

d [mm]	D [mm]	D1 [mm]	D3 [mm]	L [mm]	L2 [mm]	L3 [mm]
20	95	65	14	130	62	119
25	105	75	14	150	74	140
32	115	85	14	160	78	150
40	140	100	18	180	88	171
50	150	110	18	200	94	191
63	165	125	18	230	113	220



Ball check valve type 360 PP-H With threaded sockets NPT

Model:

- For easy installation and removal
- The ball seals at a minimum water column of 2 m
- Vibration free even at high flow velocity
- With tapered female thread NPT*

* Not available from stock

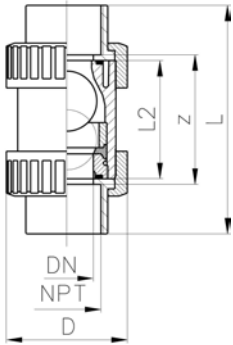

NPT [inch]	DN [mm]	PN	kv-value ($\Delta p=1$ bar) [l/min]	EPDM Code	FPM Code	kg	z [mm]	D [mm]	L [mm]	L2 [mm]
3/8	10	10	170	167 360 581	167 360 591	0.078	75	46	111	62
1/2	15	10	150	167 360 582	167 360 592	0.078	68	46	111	62
3/4	20	10	330	167 360 583	167 360 593	0.131	89	56	130	74
1	25	10	330	167 360 584	167 360 594	0.199	88	67	140	78
1 1/4	32	10	710	167 360 585	167 360 595	0.372	111	82	165	88
1 1/2	40	10	900	167 360 586	167 360 596	0.618	109	98	169	94
2	50	10	1390	167 360 587	167 360 597	1.129	136	120	199	113



Ball check valve type 360 PP-H With fusion sockets PE80 metric

Model:

- For easy installation and removal
- The ball seals at a minimum water column of 2 m
- Vibration free even at high flow velocity

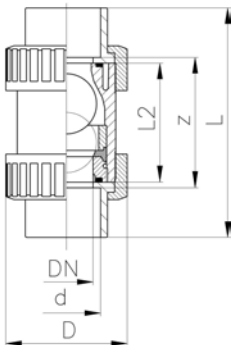

d [mm]	DN [mm]	PN	kv-value ($\Delta p=1$ bar) [l/min]	EPDM Code	FPM Code	kg	D [mm]	L [mm]	L2 [mm]	z [mm]
16	10	10	170	167 360 721	167 360 731	0.079	46	98	62	72
20	15	10	150	167 360 722	167 360 732	0.079	46	101	62	73
25	20	10	330	167 360 723	167 360 733	0.134	56	119	74	87
32	25	10	390	167 360 724	167 360 734	0.203	67	130	78	94
40	32	10	710	167 360 725	167 360 735	0.380	82	149	88	109
50	40	10	900	167 360 726	167 360 736	0.612	98	162	94	118
63	50	10	1390	167 360 727	167 360 737	1.116	120	195	113	143

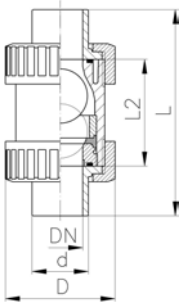

Ball check valve type 360 PP-H With spigots for electro fusion PE100 S5/SDR11

Model:

- For easy installation and removal
- The ball seals at a minimum water column of 2 m
- Vibration free even at high flow velocity

d [mm]	DN [mm]	PN	kv-value ($\Delta p=1$ bar) [l/min]	EPDM Code	FPM Code	kg	D [mm]	L [mm]	L2 [mm]
20	15	10	150	167 360 682	167 360 692	0.080	46	196	62
25	20	10	330	167 360 683	167 360 693	0.136	56	216	74
32	25	10	390	167 360 684	167 360 694	0.208	67	224	78
40	32	10	710	167 360 685	167 360 695	0.386	82	250	88
50	40	10	900	167 360 686	167 360 696	0.631	97	268	94
63	50	10	1390	167 360 687	167 360 697	1.149	119	299	113

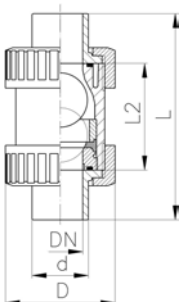

Ball check valve type 360 PP-H With butt fusion spigots PE100 S8/SDR17

Model:

- For easy installation and removal
- The ball seals at a minimum water column of 2 m
- Vibration free even at high flow velocity

d [mm]	DN [mm]	PN	kv-value ($\Delta p=1$ bar) [l/min]	EPDM Code	FPM Code	kg	D [mm]	L [mm]	L2 [mm]
40	32	6	710	167 360 665	167 360 675	0.386	82	171	88
50	40	6	900	167 360 666	167 360 676	0.631	97	191	94
63	50	6	1390	167 360 667	167 360 677	1.149	119	220	113

Spare parts for ball check valve type 360 PP-H

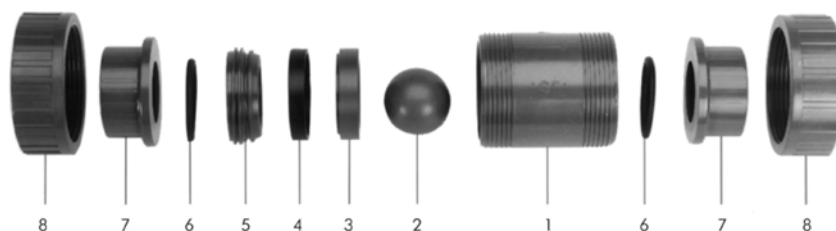

No.	Article / Material	Pieces	d16 DN 10	d20 DN 15	d25 DN 20	d32 DN 25	d40 DN 32	d50 DN 40	d63 DN 50
1	Central part Body PP	1	167 481 125	167 481 126	167 481 127	167 481 128	167 481 129	167 481 130	167 481 131
2	Ball PP	1							
3	Support ring PP	1							
4	Sealing ring EPDM	1							
5	Union bush PP	1							
1	Central part Body PP	1	167 481 135	167 481 136	167 481 137	167 481 138	167 481 139	167 481 140	167 481 141
2	Ball PP	1							
3	Support ring PP	1							
4	Sealing ring FPM	1							
5	Union bush PP	1							
8	Union nut PP-H	1	167 480 786	167 480 786	167 480 787	167 480 788	167 480 789	167 480 790	167 480 791
7	Fusion socket PP-H	1	167 480 159	167 480 160	167 480 161	167 480 162	167 480 163	167 480 164	167 480 165
7	Socket fusion spigot PP-H	1	167 480 527	167 480 528	167 480 529	167 480 530	167 480 531	167 480 532	167 480 533
7	Butt fusion spigot long PP-H SDR11	1	-	167 482 546	167 482 547	167 482 548	167 482 549	167 482 550	167 482 551
7	Threaded socket PP-H	1	167 480 166	167 480 167	167 480 168	167 480 169	167 480 170	167 480 171	167 480 172
7	Threaded socket PP-H	1	167 480 452	167 480 453	167 480 454	167 480 455	167 480 456	167 480 457	167 480 458
7	Valve end with fusion socket PE 80	1	173 480 000	173 480 001	173 480 002	173 480 003	173 480 004	173 480 005	173 480 006
7	Butt fusion spigot long PE 100 SDR11	1	-	193 480 127	193 480 128	193 480 129	193 480 130	193 480 131	193 480 132
7	Butt fusion spigot PE 100	1	193 480 026	193 480 027	193 480 028	193 480 029	193 480 030	193 480 031	193 480 032
7	Butt fusion spigot PE 100	1	-	-	193 480 014	193 480 015	193 480 016	193 480 017	193 480 018
7	Fixed flange PP-H serrated	1	-	727 740 106	727 740 107	727 740 108	727 740 109	727 740 110	727 740 111
2	Ball PP-H filled with talc y 1.24	1	167 481 165	167 481 165	167 481 166	167 481 167	167 481 168	167 481 169	167 481 170
4	Sealing ring EPDM	1	161 483 259	161 483 259	161 483 260	161 483 261	161 483 262	161 483 263	161 483 264
4	Sealing ring FPM	1	161 483 265	161 483 265	161 483 266	161 483 267	161 483 268	161 483 269	161 483 270
6	Union end seal EPDM	1	748 410 042	748 410 042	748 410 116	748 410 103	748 410 027	748 410 010	748 410 011
6	Union end seal FPM	1	749 410 042	749 410 042	749 410 116	749 410 103	749 410 027	749 410 010	749 410 011

Wafer check valves

Wafer check valve type 369 PP-H Without springs

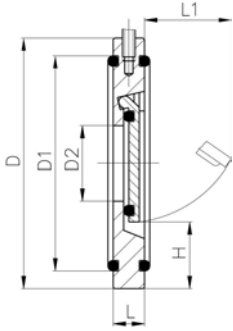

Model:

- Supporting eyelets for simple fitting
- Suitable for vertical and horizontal mounting

Installation instruction:

- It is necessary to use a special outlet flange adaptor PP or PE on the outgoing side of the wafer check valve (this applies for socket and butt fusion systems)
- Installation between ISO/DIN flange adaptors with flat jointing face.
- Centering by body diameter
- Sealing with O-rings
- A stabilizing zone of at least 5 times nominal diameter (DN) should be provided before and after the wafer check valve (10 times DN is recommended)
- No direct installation on pump flange or following bend allowed
- Wafer check valves without reset spring are not recommended for pulsating flows (production of noise)

d [mm]	DN [mm]	PN	EPDM Code	FPM Code	kg
40	32	6	167 369 002	167 369 022	0.090
50	40	6	167 369 003	167 369 023	0.100
63	50	6	167 369 004	167 369 024	0.170
75	65	6	167 369 005	167 369 025	0.220
90	80	6	167 369 006	167 369 026	0.260
110	100	6	167 369 007	167 369 027	0.370
140	125	6	167 369 009	167 369 029	0.500
160	150	6	167 369 010	167 369 030	0.740
225	200	6	167 369 011	167 369 031	1.400
280	250	6	167 369 012	167 369 032	2.400
315	300	6	167 369 013	167 369 033	3.520

d [mm]	D [mm]	D1 [mm]	D2 [mm]	H [mm]	L [mm]	L1 [mm]	Opening pressure vertical without spring in [mbar]	Opening pressure horizontal without spring in [mbar]	Minimum water column for sealing in [m]
40	85	59	18	25	15	22	10	1	3.0
50	95	72	22	28	16	25	10	1	3.0
63	109	86	32	29	18	37	10	1	3.0
75	129	105	40	31	20	50	10	1	3.0
90	144	119	54	32	20	61	10	1	3.0
110	164	146	70	31	23	77	10	1	3.0
140	195	173	92	35	23	94	10	1	3.0
160	220	197	105	42	26	100	10	1	3.0
225	275	255	154	38	35	152	18	1	3.0
280	330	312	192	41	40	180	18	1	3.0
315	380	363	227	41	45	215	18	1	3.0

d [mm]	Number of screws with washer	Torque [Nm]	Number of nut rotations after tightening by hand
40	4xM16/90	10	1
50	4xM16/95	12	1
63	4xM16/110	15	1
75	4xM16/140	18	1
90	8xM16/150	20	1
110	8xM16/160	22	1
140	8xM16/180	25	1
160	8xM20/200	30	1
225	8xM20/220	60	1
280	12xM20/240	60	1
315	12xM20/260	60	1

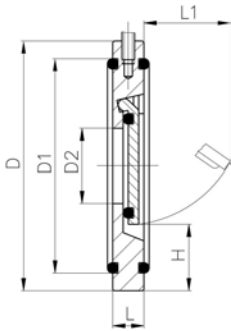

Wafer check valve type 369 PP-H With V4A springs (stainless steel)

Model:

- Supporting eyelets for simple fitting
- Suitable for vertical and horizontal mounting

Installation instruction:

- It is necessary to use a special outlet flange adaptor PP or PE on the outgoing side of the wafer check valve (this applies for socket and butt fusion systems)
- Installation between ISO/DIN flange adaptors with flat jointing face.
- Centering by body diameter
- Sealing with O-rings
- A stabilizing zone of at least 5 times nominal diameter (DN) should be provided before and after the wafer check valve (10 times DN is recommended)
- No direct installation on pump flange or following bend allowed
- Wafer check valves without reset spring are not recommended for pulsating flows (production of noise)

d [mm]	DN [mm]	PN	EPDM Code	FPM Code	kg
40	32	6	167 369 042	167 369 062	0.090
50	40	6	167 369 043	167 369 063	0.100
63	50	6	167 369 044	167 369 064	0.170
75	65	6	167 369 045	167 369 065	0.220
90	80	6	167 369 046	167 369 066	0.260
110	100	6	167 369 047	167 369 067	0.370
140	125	6	167 369 049	167 369 069	0.500
160	150	6	167 369 050	167 369 070	0.740
225	200	6	167 369 051	167 369 071	1.400
280	250	6	167 369 052	167 369 072	2.400
315	300	6	167 369 053	167 369 073	3.520

d [mm]	D [mm]	D1 [mm]	D2 [mm]	H [mm]	L [mm]	L1 [mm]	Opening pressure vertical with spring in [mbar]	Opening pressure horizontal with spring in [mbar]	Minimum water column for sealing in [m]
40	85	59	18	25	15	22	30	20	3.0
50	95	72	22	28	16	25	30	20	3.0
63	109	86	32	29	18	37	30	20	3.0
75	129	105	40	31	20	50	30	20	3.0
90	144	119	54	32	20	61	30	20	3.0
110	164	146	70	31	23	77	30	20	3.0
140	195	173	92	35	23	94	30	20	3.0
160	220	197	105	42	26	100	30	20	3.0
225	275	255	154	38	35	152	38	20	3.0
280	330	312	192	41	40	180	38	20	3.0
315	380	363	227	41	45	215	38	20	3.0

d [mm]	Number of screws with washer	Torque [Nm]	Number of nut rotations after tightening by hand
40	4xM16x90	10	1
50	4xM16x95	12	1
63	4xM16x110	15	1
75	4xM16x140	18	1
90	8xM16x150	20	1
110	8xM16x160	22	1
140	8xM16x180	25	1
160	8xM20x200	30	1
225	8xM20x220	60	1
280	12xM20x240	60	1
315	12xM20x260	60	1



Wafer check valve type 369 PP-H With Hastelloy C springs

Model:

- Supporting eyelets for simple fitting
- Suitable for vertical and horizontal mounting

Installation instruction:

- It is necessary to use a special outlet flange adaptor PP or PE on the outgoing side of the wafer check valve (this applies for socket and butt fusion systems)
- Installation between ISO/DIN flange adaptors with flat jointing face.
- Centering by body diameter
- Sealing with O-rings
- A stabilizing zone of at least 5 times nominal diameter (DN) should be provided before and after the wafer check valve (10 times DN is recommended)
- No direct installation on pump flange or following bend allowed
- Wafer check valves without reset spring are not recommended for pulsating flows (production of noise)

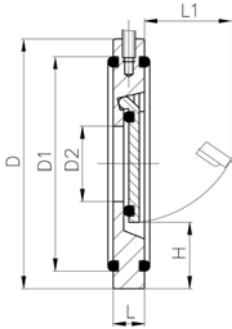

d [mm]	DN [mm]	PN	EPDM Code	FPM Code	kg
40	32	6	167 369 082	167 369 102	0.090
50	40	6	167 369 083	167 369 103	0.100
63	50	6	167 369 084	167 369 104	0.170
75	65	6	167 369 085	167 369 105	0.220
90	80	6	167 369 086	167 369 106	0.260
110	100	6	167 369 087	167 369 107	0.370
140	125	6	167 369 089	167 369 109	0.500
160	150	6	167 369 090	167 369 110	0.740
225	200	6	167 369 091	167 369 111	1.400
280	250	6	167 369 092	167 369 112	2.400
315	300	6	167 369 093	167 369 113	3.520

d [mm]	D [mm]	D1 [mm]	D2 [mm]	H [mm]	L [mm]	L1 [mm]	Opening pressure vertical with spring in [mbar]	Opening pressure horizontal with spring in [mbar]	Minimum water column for sealing in [m]
40	85	59	18	25	15	22	30	20	3.0
50	95	72	22	28	16	25	30	20	3.0
63	109	86	32	29	18	37	30	20	3.0
75	129	105	40	31	20	50	30	20	3.0
90	144	119	54	32	20	61	30	20	3.0
110	164	146	70	31	23	77	30	20	3.0
140	195	173	92	35	23	94	30	20	3.0
160	220	197	105	42	26	100	30	20	3.0
225	275	255	154	38	35	152	38	20	3.0
280	330	312	192	41	40	180	38	20	3.0
315	380	363	227	41	45	215	38	20	3.0

d [mm]	Number of screws with washer	Torque [Nm]	Number of nut rotations after tightening by hand
40	4xM16/90	10	1
50	4xM16/95	12	1
63	4xM16/110	15	1
75	4xM16/140	18	1
90	8xM16/150	20	1
110	8xM16/160	22	1
140	8xM16/180	25	1
160	8xM20/200	30	1
225	8xM20/220	60	1
280	12xM20/240	60	1
315	12xM20/260	60	1

Spare parts for wafer check valve type 369 PP-H

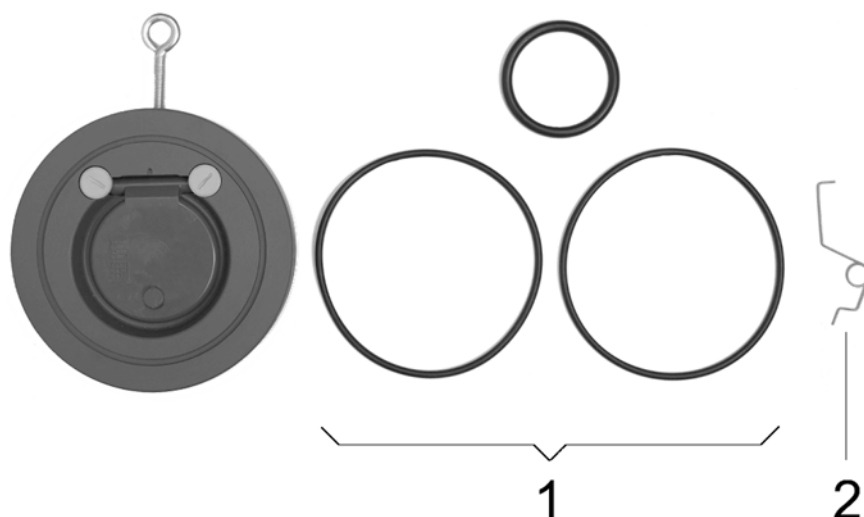

No.	Article / Material	Pieces	d40 DN 32	d50 DN 40	d63 DN 50	d75 DN 65	d90 DN 80	d110 DN 100	d140 DN 125
1	Seal set Body seal EPDM	2	161 484 875	161 484 876	161 484 877	161 484 878	161 484 879	161 484 880	161 484 881
1	Seal set Body seal FPM	2	161 484 887	161 484 888	161 484 889	161 484 890	161 484 891	161 484 892	161 484 893
2	Spring V4A	1	161 484 900	161 484 901	161 484 902	161 484 903	161 484 904	161 484 905	161 484 906

No.	Article / Material	Pieces	d160 DN 150	d225 DN 200	d280 DN 250	d315 DN 300
1	Seal set Body seal EPDM	2	161 484 882	161 484 883	161 484 884	161 484 885
1	Seal set Body seal FPM	2	161 484 894	161 484 895	161 484 896	161 484 897
2	Spring V4A	1	161 484 907	161 484 908	161 484 909	161 484 910

Strainers

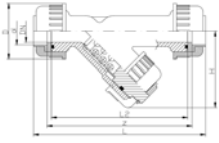

Line strainer type 305 PP-H With fusion sockets metric

Model:

- For easy installation and removal
- Protects valves, pumps, etc. from becoming soiled
- Screen perforation 0.5 mm
- Overall length according to EN 558-1

d [mm]	DN [mm]	PN	kv-value ($\Delta p=1$ bar) [l/min]	EPDM Code	FPM Code	kg	D [mm]	L [mm]	L2 [mm]	H [mm]	z [mm]
20	15	10	35	167 305 000	167 305 049	0.245	52	168	130	75	140
25	20	10	65	167 305 050	167 305 099	0.295	62	192	150	80	160
32	25	10	90	167 305 100	167 305 149	0.360	68	206	160	90	170
40	32	10	155	167 305 150	167 305 199	0.660	85	230	180	110	190
50	40	10	225	167 305 200	167 305 249	0.810	85	256	200	125	210
63	50	10	370	167 305 250	167 305 299	1.330	102	294	230	150	240

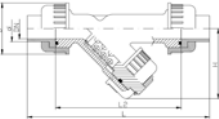

Line strainer type 305 PP-H With butt fusion spigots SDR11 metric

Model:

- For easy installation and removal
- Protects valves, pumps, etc. from becoming soiled
- Screen perforation 0.5 mm
- Overall length according to EN 558-1

d [mm]	DN [mm]	PN	kv-value ($\Delta p=1$ bar) [l/min]	EPDM Code	FPM Code	kg	D [mm]	L [mm]	L2 [mm]	H [mm]
20	15	10	35	167 305 300	167 305 349	0.245	52	238	130	75
25	20	10	65	167 305 350	167 305 399	0.295	62	264	150	80
32	25	10	90	167 305 400	167 305 449	0.360	68	280	160	90
40	32	10	155	167 305 450	167 305 499	0.660	85	306	180	110
50	40	10	225	167 305 500	167 305 549	0.810	85	332	200	125
63	50	10	370	167 305 550	167 305 599	1.330	102	368	230	150

Accessories Hand Operated Valves

Handle extension 546 PVC-U inch BS/ASTM

- For Ball Valve Type 546

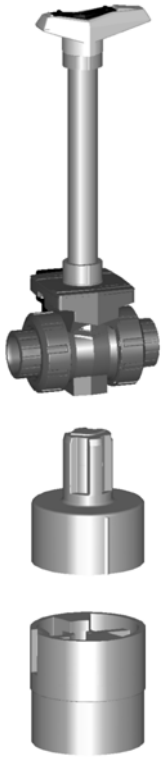

DN-DN [mm]	Inch	Code	kg	H [mm]	H1 [mm]	H2 [mm]	H3 [mm]	D [mm]
10 - 15	3/8-1/2	161 486 443	0.032	41	52	29	36	26
20 - 25	3/4-1	161 486 444	0.037	50	62	32	39	36
32 - 40	1 1/4-1 1/2	161 486 445	0.047	65	76	34	44	40
50 -	2	161 486 446	0.058	84	87	37	48	44

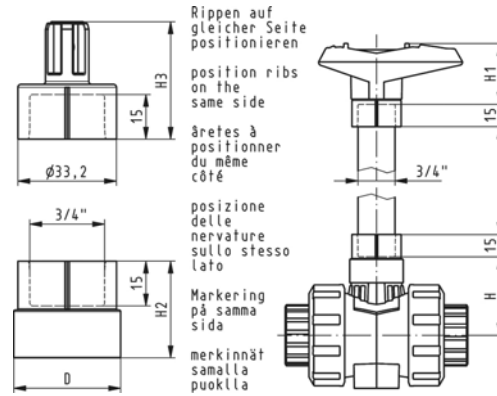

Mounting plate 546 PP-GF (L02)

- 2 mounting screws inclusive

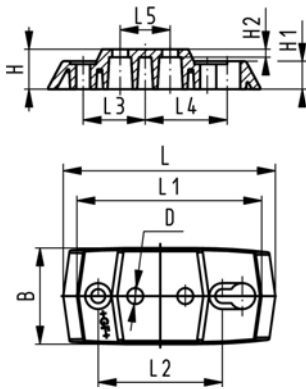

d-d [mm]	DN-DN [mm]	Code	kg
16 - 32	10 - 25	167 484 110	0.055
40 - 63	32 - 50	167 484 111	0.086

d-d [mm]	B [mm]	D [mm]	H [mm]	H1 [mm]	H2 [mm]	L [mm]	L1 [mm]	L2 [mm]	L3 [mm]	L4 [mm]	L5 [mm]
16 - 32	48	8	20	14	4	106	92	62	31	41	25
40 - 63	54	9	20	14	4	149	134	104	52	62	45

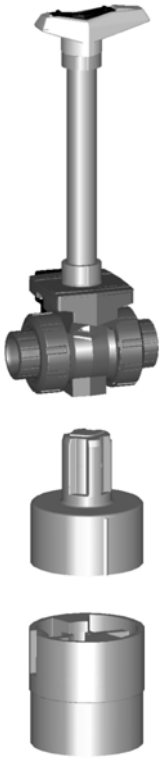

Handle extension 546 PVC-U metric

Model:

- For Ball Valve Type 546
- Composed of adapter sockets for handle connection and stem connection
- PVC-U pipe in suitable length has to be obtained on site

d-d [mm]	DN-DN [mm]	Code	kg	H [mm]	H1 [mm]	H2 [mm]	H3 [mm]	D [mm]
16 - 20	10 - 15	161 486 435	0.032	41	52	29	36	26
25 - 32	20 - 25	161 486 436	0.037	50	62	32	39	36
40 - 50	32 - 40	161 486 437	0.047	65	76	34	44	40
- 63	- 50	161 486 438	0.058	84	87	37	48	44

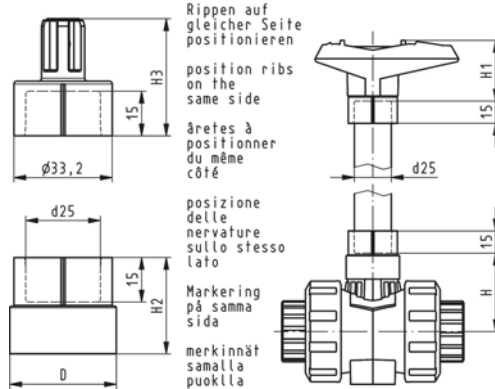

Handle extension Type 615 PVC-U

- For Ball Valves Type 323, 343 and 346

d [mm]	DN [mm]	Inch	Code	kg	H [mm]	H1 [mm]	H2 [mm]	H3 [mm]
16-20	10-15	3/8-1/2	161 483 561	0.160	102	102	37	59
25	20	3/4	161 483 562	0.170	114	114	40	62
32	25	1	161 483 563	0.280	127	127	42	65
40	32	1 1/4	161 483 564	0.400	137	137	43	67
50	40	1 1/2	161 483 565	0.055	152	152	46	69
63	50	2	161 483 566	0.056	175	175	51	71

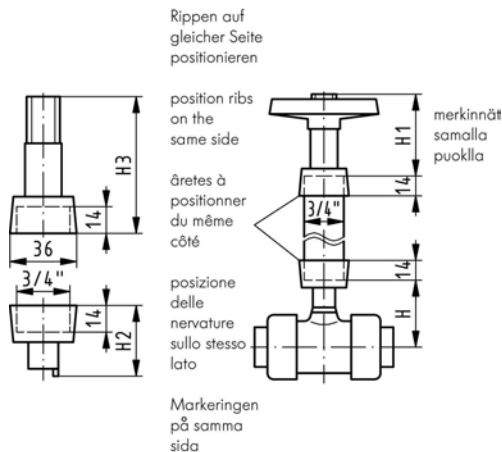



Pipe PVC-U

- For Handle Extension Type 615

d [inch]	Code	kg	l [mm]	l [mm]	
3/4	161 483 570	0.075	200	200	
3/4	161 483 571	0.200	1000	1000	

Accessories diaphragm valves type 314

Mounting block PP

- For Diaphragm Valves 314, 315 and 317 (DN 15-50)

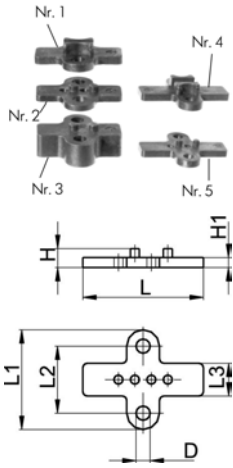

d-d [mm]	DN-DN [mm]	Inch	Block no.	Code	kg
20 - 32	15 - 20	1/2 - 1	1	167 480 422	0.005
16 - 20	10 - 15	3/8 - 1/2	2	167 480 423	0.003
-	-	-	3	167 480 424	0.012
40 - 63	32 - 50	1 1/4 - 2 1/2	4	167 480 425	0.017
-	-	-	5	167 480 426	0.015

d-d [mm]	D [mm]	H [mm]	H1 [mm]	L [mm]	L1 [mm]	L2 [mm]	L3 [mm]
20 - 32	8	11	5	47	42	25	17
16 - 20	8	7	4	47	42	25	17
-	8	17	14	47	42	25	17
40 - 63	10	18	7	81	67	45	22
-	10	13	7	81	67	45	22

Equalizing the Assembly Height over all Sizes

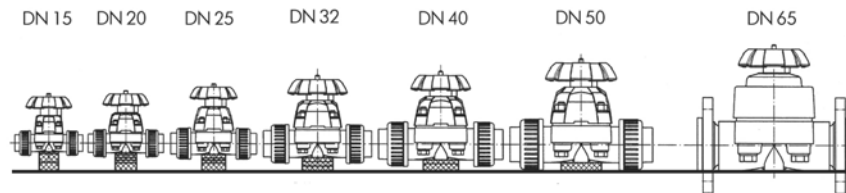

Quantity required x block number



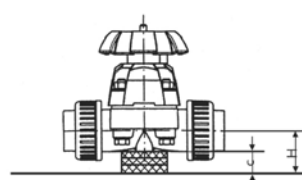

... to DN	d 20 DN 15	d 25 DN 20	d 32 DN 25	d 40 DN 32	d 50 DN 40	d 63 DN 50	d 75 DN 65
15		1 x 2	2 x 2	1 x 1 + 2 x 2	1 x 1 + 1 x 3	1 x 1 + 2 x 2 + 1 x 3	1 x 1 + 2 x 3
20			1 x 2	1 x 1 + 1 x 2	1 x 1 + 3 x 2	1 x 1 + 1 x 2 + 1 x 3	1 x 1 + 3 x 2 + 1 x 3
25				1 x 1	1 x 1 + 2 x 2	1 x 1 + 1 x 3	1 x 1 + 2 x 2 + 1 x 3
32					1 x 4	1 x 4 + 1 x 5	1 x 4 + 2 x 5
40						1 x 4	1 x 4 + 1 x 5
50							1 x 4

Equalizing the Union Height for Type 314



DN mm	Quantity required x block number	C mm	H mm
15			22.5
20	1 x 1 + 2 x 2	11.5	29
25			32.5
32			39
40	1 x 4 + 1 x 5	13.5	46
50			52.5

PROGEF® Natural

		Page
	Pipes	162
	Butt Fusion Fittings	163
	Adaptor Fittings for Butt Fusion	168
	Butt Fusion Unions	172
	Diaphragm valves	173

Pipes

68 48 01

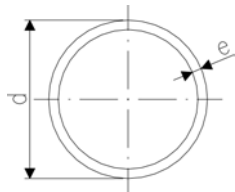

PP-N S5/SDR11 (PN10)

Model:

- Material: Polypropylene-Natural, Material Type: PP-R (unpigmented)
- Colour: natural
- Length: Lengths of 5 m
- Bead and Crevice Free weldable with the new BCF® Plus fusion machine
- Infrared-(IR Plus®) compatible. Please choose fusion parameters: PP-n (PP-R)
- Conventional butt-welding according to DVS 2207 part 1

d [mm]	Code	kg/m	e [mm]
20	168 480 151	0.107	1,9
25	168 480 152	0.164	2,3
32	168 480 153	0.261	2,9
40	168 480 154	0.412	3,7
50	168 480 155	0.638	4,6
63	168 480 156	1.010	5,8

68 48 02

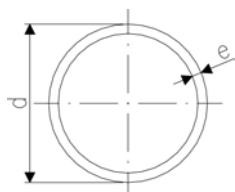

PP-N S8,3/SDR17,6 (PN6)

Model:

- Material: Polypropylene-Natural, Material Type: PP-R (unpigmented)
- Colour: natural
- Length: Lengths of 5 m
- Bead and Crevice Free weldable with the new BCF® Plus fusion machine
- Infrared-(IR Plus®) compatible. Please choose fusion parameters: PP-n (PP-R)
- Conventional butt-welding according to DVS 2207 part 1

d [mm]	Code	kg/m	e [mm]
75	168 480 282	0.935	4,3
90	168 480 283	1.330	5,1
110	168 480 284	1.990	6,3

Butt Fusion Fittings

Elbow 90°, S5/SDR11

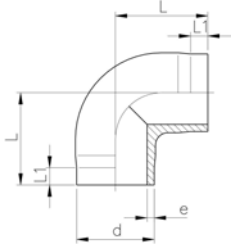

Model:

- Material: Polypropylene-Natural, Material Type: PP-R (unpigmented)
- Bead and Crevice Free weldable with the new BCF® Plus fusion machine
- Infrared-(IR Plus®) compatible. Please choose fusion parameters: PP-n (PP-R)
- Conventional butt-welding according to DVS 2207 part 1

d [mm]	FM	Code	SP	kg	L [mm]	L1 [mm]	e [mm]	
20	BCF, IR	728 108 506	10	0.008	38	25	1,9	
25	BCF, IR	728 108 507	10	0.013	42	26	2,3	
32	BCF, IR	728 108 508	10	0.022	46	27	2,9	
40	BCF, IR	728 108 509	10	0.044	51	22	3,7	
50	BCF, IR	728 108 510	10	0.077	58	23	4,6	
63	BCF, IR	728 108 511	-	0.138	66	21	5,8	

Bend 90°, S8,3/SDR17,6

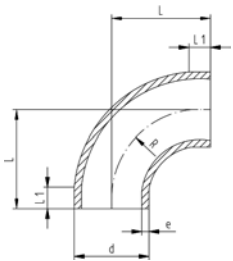

Model:

- Material: Polypropylene-Natural, Material Type: PP-R (unpigmented)
- Bead and Crevice Free weldable with the new BCF® Plus fusion machine
- Infrared-(IR Plus®) compatible. Please choose fusion parameters: PP-n (PP-R)
- Conventional butt-welding according to DVS 2207 part 1

d [mm]	FM	Code	SP	kg	L [mm]	L1 [mm]	e [mm]	R [mm]	
75	BCF, IR	728 018 412	-	0.156	100	20	4,3	90	
90	BCF, IR	728 018 413	-	0.221	100	20	5,1	90	
110	BCF, IR	728 018 414	-	0.474	141	25	6,3	130	



Elbow 45°, S5/SDR11

Model:

- Material: Polypropylene-Natural, Material Type: PP-R (unpigmented)
- Bead and Crevice Free weldable with the new BCF® Plus fusion machine
- Infrared-(IR Plus®) compatible. Please choose fusion parameters: PP-n (PP-R)
- Conventional butt-welding according to DVS 2207 part 1

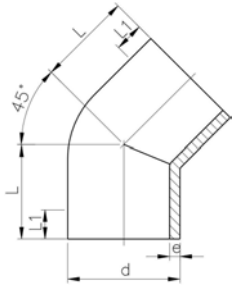

d [mm]	FM	Code	SP	kg	L [mm]	L1 [mm]	e [mm]
20	BCF, IR	728 158 506	10	0.008	32	24	1,9
25	BCF, IR	728 158 507	10	0.012	34	25	2,3
32	BCF, IR	728 158 508	10	0.022	36	25	2,9
40	BCF, IR	728 158 509	10	0.037	39	25	3,7
50	BCF, IR	728 158 510	10	0.054	42	26	4,6
63	BCF, IR	728 158 511	10	0.097	47	29	5,8



Elbow 45°, S8,3/SDR17,6

Model:

- Material: Polypropylene-Natural, Material Type: PP-R (unpigmented)
- Bead and Crevice Free weldable with the new BCF® Plus fusion machine
- Infrared-(IR Plus®) compatible. Please choose fusion parameters: PP-n (PP-R)
- Conventional butt-welding according to DVS 2207 part 1

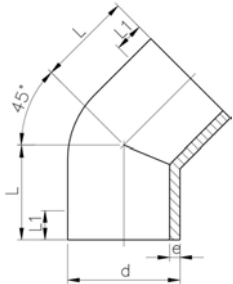

d [mm]	FM	Code	SP	kg	L [mm]	L1 [mm]	e [mm]
75	BCF, IR	728 158 412	-	0.099	49	33	4,8
90	BCF, IR	728 158 413	-	0.164	57	48	5,7
110	BCF, IR	728 158 414	-	0.296	70	38	6,9



Tee 90° equal, S5/SDR11

Model:

- Material: Polypropylene-Natural, Material Type: PP-R (unpigmented)
- Bead and Crevice Free weldable with the new BCF® Plus fusion machine
- Infrared-(IR Plus®) compatible. Please choose fusion parameters: PP-n (PP-R)
- Conventional butt-welding according to DVS 2207 part 1

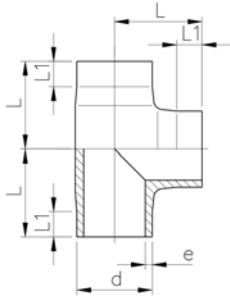

d [mm]	FM	Code	SP	kg	L [mm]	L1 [mm]	e [mm]
20	BCF, IR	728 208 506	10	0.011	38	24	1,9
25	BCF, IR	728 208 507	10	0.019	42	26	2,3
32	BCF, IR	728 208 508	5	0.032	46	26	2,9
40	BCF, IR	728 208 509	10	0.059	51	23	3,7
50	BCF, IR	728 208 510	10	0.103	58	22	4,6
63	BCF, IR	728 208 511	5	0.184	66	20	5,8



Tee 90° equal, S8,3/SDR17,6

Model:

- Material: Polypropylene-Natural, Material Type: PP-R (unpigmented)
- Bead and Crevice Free weldable with the new BCF® Plus fusion machine
- Infrared-(IR Plus®) compatible. Please choose fusion parameters: PP-n (PP-R)
- Conventional butt-welding according to DVS 2207 part 1

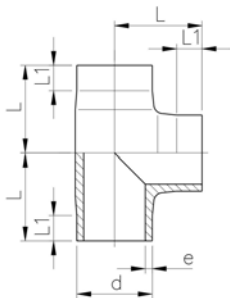

d [mm]	FM	Code	SP	kg	L [mm]	L1 [mm]	e [mm]
75	BCF, IR	728 208 412	-	0.230	75	20	4,8
90	BCF, IR	728 208 413	-	0.401	90	20	5,7
110	BCF, IR	728 208 414	-	0.723	110	20	6,9

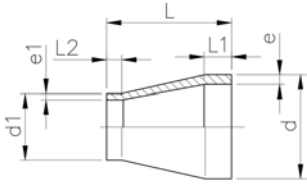

Reducer, S5/SDR11

Model:

- Material: Polypropylene-Natural, Material Type: PP-R (unpigmented)
- Bead and Crevice Free weldable with the new BCF® Plus fusion machine
- Infrared-(IR Plus®) compatible. Please choose fusion parameters: PP-n (PP-R)
- Conventional butt-welding according to DVS 2207 part 1

d	d1	FM	Code	SP	kg	L	L1	L2	e	e1
[mm]	[mm]					[mm]	[mm]	[mm]	[mm]	[mm]
25	20	BCF, IR	728 908 537	10	0.007	50	20	20	2,3	1,9
32	20	BCF, IR	728 908 542	10	0.010	50	20	20	3,0	1,9
32	25	BCF, IR	728 908 541	10	0.011	50	20	20	3,0	2,3
40	20	BCF, IR	728 908 548	10	0.015	58	20	23	3,7	1,9
40	25	BCF, IR	728 908 547	10	0.016	55	20	20	3,7	2,3
40	32	BCF, IR	728 908 546	10	0.019	55	20	20	3,7	2,9
50	25	BCF, IR	728 908 554	10	0.025	60	20	20	4,6	2,3
50	32	BCF, IR	728 908 553	10	0.027	60	20	20	4,6	2,9
50	40	BCF, IR	728 908 552	10	0.030	60	20	20	4,6	3,7
63	32	BCF, IR	728 908 560	10	0.043	65	20	20	5,8	2,9
63	40	BCF, IR	728 908 559	10	0.047	65	20	20	5,8	3,7
63	50	BCF, IR	728 908 558	10	0.052	65	20	20	5,8	4,6

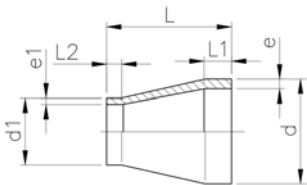

Reducer, S8,3/SDR17,6

Model:

- Material: Polypropylene-Natural, Material Type: PP-R (unpigmented)
- Bead and Crevice Free weldable with the new BCF® Plus fusion machine
- Infrared-(IR Plus®) compatible. Please choose fusion parameters: PP-n (PP-R)
- Conventional butt-welding according to DVS 2207 part 1

* SDR17,6 - SDR11

d	d1	FM	Code	SP	kg	L	L1	L2	e	e1
[mm]	[mm]					[mm]	[mm]	[mm]	[mm]	[mm]
*75	40	BCF, IR	728 908 466	10	0.048	68	20	23	4,8	3,7
*75	50	BCF, IR	728 908 465	10	0.051	65	20	20	4,8	4,6
*75	63	BCF, IR	728 908 464	10	0.060	65	20	20	4,8	5,8
*90	63	BCF, IR	728 908 471	-	0.086	75	22	19	5,7	5,8
*90	75	BCF, IR	728 908 470	-	0.086	75	21	19	5,7	4,8
110	75	BCF, IR	728 908 477	-	0.135	90	26	20	6,9	4,8
110	90	BCF, IR	728 908 476	-	0.154	90	25	22	6,9	5,7

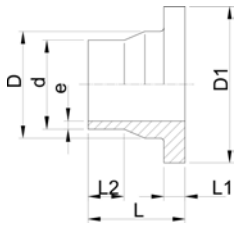

Flange Adaptor, S5/SDR11 Jointing Face serrated

Model:

- Material: Polypropylene-Natural, Material Type: PP-R (unpigmented)
- Bead and Crevice Free weldable with the new BCF® Plus fusion machine
- Infrared-(IR Plus®) compatible. Please choose fusion parameters: PP-n (PP-R)
- Conventional butt-welding according to DVS 2207 part 1

d [mm]	FM	Code	SP	kg	D [mm]	D1 [mm]	L [mm]	L1 [mm]	L2 [mm]	e [mm]
20	BCF, IR	728 798 506	10	0.015	26	45	50	7	29	1,9
25	BCF, IR	728 798 507	10	0.028	32	58	52	9	27	2,3
32	BCF, IR	728 798 508	10	0.042	40	68	54	10	28	2,9
40	BCF, IR	728 798 509	10	0.064	49	78	55	11	25	3,7
50	BCF, IR	728 798 510	-	0.088	60	88	62	12	32	4,6
63	BCF, IR	728 798 511	-	0.141	75	102	68	14	38	5,8

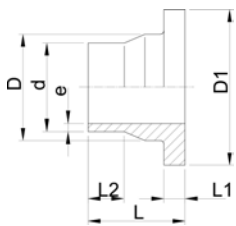

Flange Adaptor, S8,3/SDR17,6 Jointing Face serrated

Model:

- Material: Polypropylene-Natural, Material Type: PP-R (unpigmented)
- Bead and Crevice Free weldable with the new BCF® Plus fusion machine
- Infrared-(IR Plus®) compatible. Please choose fusion parameters: PP-n (PP-R)
- Conventional butt-welding according to DVS 2207 part 1

d [mm]	FM	Code	SP	kg	D [mm]	D1 [mm]	L [mm]	L1 [mm]	L2 [mm]	e [mm]
75	BCF, IR	728 798 412	-	0.202	89	122	80	16	43	4,8
90	BCF, IR	728 798 413	-	0.271	105	138	80	17	41	5,7
110	BCF, IR	728 798 414	-	0.354	125	158	80	18	40	6,9

Adaptor Fittings for Butt Fusion

Adaptor Socket, metric - Rp

Model:

- Polypropylene, Material Type: PP-R (unpigmented)
- With butt fusion spigot **SDR11** and BSP parallel female thread Rp, reinforced
- Connection to plastic or metal
- Reinforcing ring stainless (A2)
- Do not use thread sealing pastes that are harmful to PP

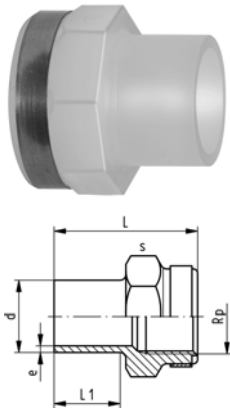

d [mm]	FM	Rp [inch]	PN	Code	SP	kg	L [mm]	L1 [mm]	s [mm]	e [mm]
20	BCF, IR	1/2	10	728 918 056	-	0.017	49	28	32	1,9
25	BCF, IR	3/4	10	728 918 057	-	0.022	51	28	36	2,3
32	BCF, IR	1	10	728 918 058	-	0.039	54	28	46	2,9
40	BCF, IR	1 1/4	10	728 918 059	-	0.057	56	28	55	3,7
50	BCF, IR	1 1/2	10	728 918 060	-	0.085	60	28	64	4,6
63	BCF, IR	2	10	728 918 061	-	0.140	62	28	80	5,8

Adaptor Nipple, metric - R

Model:

- Polypropylene, Material Type: PP-R (unpigmented)
- With butt fusion spigot and BSP tapered male thread
- Connection to plastic thread only
- Do not use thread sealing pastes that are harmful to PP

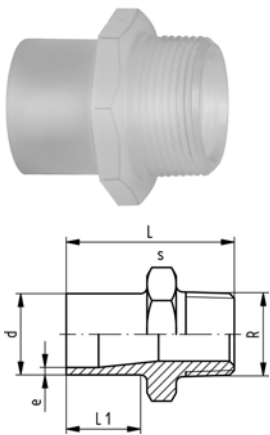

d [mm]	FM	R [inch]	PN	Code	SP	kg	L [mm]	L1 [mm]	s [mm]	e [mm]
20	BCF, IR	1/2	10	728 918 106	-	0.013	51	28	32	1,9
25	BCF, IR	3/4	10	728 918 107	-	0.017	52	28	36	2,3
32	BCF, IR	1	10	728 918 108	-	0.027	55	28	46	2,9
40	BCF, IR	1 1/4	10	728 918 109	-	0.041	58	28	55	3,7
50	BCF, IR	1 1/2	10	728 918 110	-	0.060	60	28	65	4,6
63	BCF, IR	2	10	728 918 111	-	0.098	67	28	80	5,8

Adaptor Sockets, metric - NPT

Model:

- Polypropylene, Material Type: PP-R (unpigmented)
- With butt fusion spigot **SDR11** and NPT tapered male thread
- Connection to plastic or metal
- Reinforcing ring stainless (A2)
- Do not use thread sealing pastes that are harmful to PP

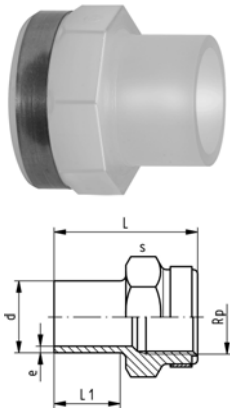

d [mm]	FM	NPT [inch]	PN	Code	SP	kg	L [mm]	L1 [mm]	s [mm]	e [mm]
20	BCF, IR	1/2	10	728 914 056	-	0.017	49	28	32	1,9
25	BCF, IR	3/4	10	728 914 057	-	0.022	51	28	36	2,3
32	BCF, IR	1	10	728 914 058	-	0.039	54	28	46	2,9
40	BCF, IR	1 1/4	10	728 914 059	-	0.057	56	28	55	3,7
50	BCF, IR	1 1/2	10	728 914 060	-	0.085	60	28	64	4,6
63	BCF, IR	2	10	728 914 061	-	0.140	62	28	80	5,8

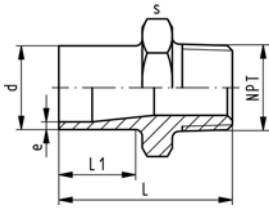

Adaptor Nipple, metric - NPT

Model:

- Polypropylene, Material Type: PP-R (unpigmented)
- With butt fusion spigot **SDR11** and BSP parallel female thread Rp, reinforced
- Connection to plastic thread only
- Reinforcing ring stainless (A2)
- Do not use thread sealing pastes that are harmful to PP

d [mm]	NPT [inch]	PN	FM	Code	SP	kg	L [mm]	L1 [mm]	s [mm]	e [mm]
20	½	10	BCF, IR	728 914 106	-	0.013	51	28	32	1,9
25	¾	10	BCF, IR	728 914 107	-	0.017	52	28	36	2,3
32	1	10	BCF, IR	728 914 108	-	0.027	55	28	46	2,9
40	1 ¼	10	BCF, IR	728 914 109	-	0.041	58	28	55	3,7
50	1 ½	10	BCF, IR	728 914 110	-	0.060	60	28	65	4,6
63	2	10	BCF, IR	728 914 111	-	0.098	67	28	80	5,8

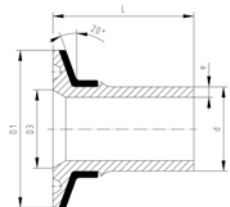

Sanitary Adaptor Connection to ISO 1127

Model:

- Polypropylene, Material Type: PP-R (unpigmented)
- Stainless steel reinforcement ring
- Bead and Crevice Free weldable with the new BCF® Plus fusion machine
- Infrared-(IR Plus®) compatible. Please choose fusion parameters: PP-n (PP-R)

d [mm]	FM	DN [mm]	PN	Code	SP	kg	D1 [mm]	D3 [mm]	L [mm]	e [mm]
20	BCF, IR	15	10	728 598 006	-	0.031	50	18	49.0	1,9
25	BCF, IR	20	10	728 598 008	-	0.032	50	24	49.5	2,3
25	BCF, IR	25	10	728 598 009	-	0.031	50	30	49.5	2,3
32	BCF, IR	25	10	728 598 010	-	0.033	50	30	53.0	2,9
40	BCF, IR	32	10	728 598 014	-	0.054	64	35	54.0	3,7
50	BCF, IR	40	10	728 598 016	-	0.062	64	44	61.0	4,6
63	BCF, IR	50	10	728 598 018	-	0.093	78	56	67.0	5,8

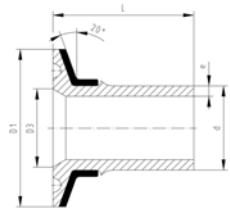

Sanitary Adaptor Connection to DIN 32676

Model:

- Polypropylene, Material Type: PP-R (unpigmented)
- Stainless steel reinforcement ring
- Bead and Crevice Free weldable with the new BCF® Plus fusion machine
- Infrared-(IR Plus®) compatible. Please choose fusion parameters: PP-n (PP-R)

d [mm]	FM	DN [mm]	PN	Code	SP	kg	D1 [mm]	D3 [mm]	L [mm]	e [mm]
20	BCF, IR	15	10	728 598 056	-	0.014	34	16	49.0	1,9
20	BCF, IR	20	10	728 598 057	-	0.014	34	20	49.0	1,9
25	BCF, IR	25	10	728 598 059	-	0.031	50	26	49.5	2,3
32	BCF, IR	32	10	728 598 062	-	0.031	50	32	53.0	2,9
40	BCF, IR	40	10	728 598 065	-	0.032	50	38	54.0	3,7
50	BCF, IR	50	10	728 598 067	-	0.061	64	50	61.0	4,6



Sanitary Adaptor Connection to DIN 3017

Model:

- Polypropylene, Material Type: PP-R (unpigmented)
- Stainless steel reinforcement ring
- Bead and Crevice Free weldable with the new BCF® Plus fusion machine
- Infrared-(IR Plus®) compatible. Please choose fusion parameters: PP-n (PP-R)

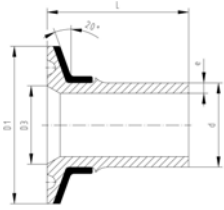

d [mm]	FM	DN [mm]	PN	Code	SP	kg	D1 [mm]	D3 [mm]	L [mm]	e [mm]
25	BCF, IR	25	10	728 598 259	-	0.031	50	22	49.5	2,3
32	BCF, IR	32	10	728 598 262	-	0.031	50	32	53.0	2,9
40	BCF, IR	40	10	728 598 265	-	0.033	50	35	54.0	3,7
50	BCF, IR	50	10	728 598 267	-	0.061	64	49	61.0	4,6
63	BCF, IR	65	10	728 598 269	-	0.093	78	60	67.0	5,8



Sanitary Adaptor Connection to ISO 2852

Model:

- Polypropylene, Material Type: PP-R (unpigmented)
- Stainless steel reinforcement ring
- Bead and Crevice Free weldable with the new BCF® Plus fusion machine
- Infrared-(IR Plus®) compatible. Please choose fusion parameters: PP-n (PP-R)

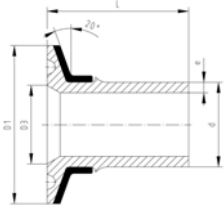

d [mm]	FM	DN [mm]	PN	Code	SP	kg	D1 [mm]	D3 [mm]	L [mm]	e [mm]
25	BCF, IR	25	10	728 598 309	-	0.031	51	22	50	2,3
32	BCF, IR	32	10	728 598 312	-	0.031	51	32	53	2,9
40	BCF, IR	40	10	728 598 315	-	0.033	51	35	54	3,7
50	BCF, IR	50	10	728 598 317	-	0.061	64	49	61	4,6
63	BCF, IR	65	10	728 598 319	-	0.093	78	60	67	5,8



Sanitary Adaptor Connection to ASME BPE

Model:

- Polypropylene, Material Type: PP-R (unpigmented)
- Stainless steel reinforcement ring
- Bead and Crevice Free weldable with the new BCF® Plus fusion machine
- Infrared-(IR Plus®) compatible. Please choose fusion parameters: PP-n (PP-R)

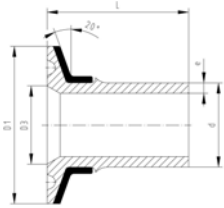

* Without stainless steel reinforcement ring

d [mm]	FM	Inch	PN	Code	SP	kg	D1 [mm]	D3 [mm]	L [mm]	e [mm]
*20	BCF, IR	3/4	10	728 598 357	-	0.006	25	16	49	1,9
25	BCF, IR	1	10	728 598 359	-	0.031	51	22	50	2,3
40	BCF, IR	1 1/2	10	728 598 365	-	0.032	51	35	54	3,7
50	BCF, IR	2	10	728 598 367	-	0.061	64	48	61	4,6
63	BCF, IR	2 1/2	10	728 598 369	-	0.093	78	60	67	5,8

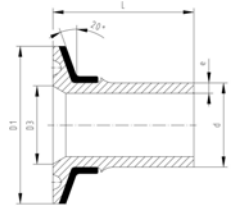

Sanitary Adaptor Connection to JIS G3447

Model:

- Polypropylene, Material Type: PP-R (unpigmented)
- Stainless steel reinforcement ring
- Bead and Crevice Free weldable with the new BCF® Plus fusion machine
- Infrared-(IR Plus®) compatible. Please choose fusion parameters: PP-n (PP-R)

d [mm]	FM	DN [mm]	PN	Code	SP	kg	D1 [mm]	D3 [mm]	L [mm]	e [mm]
20	BCF, IR	15	10	728 598 406	-	0.014	34	18	49.0	1,9
25	BCF, IR	20	10	728 598 408	-	0.032	50	23	49.5	2,3
32	BCF, IR	25	10	728 598 410	-	0.033	50	30	53.0	2,9
40	BCF, IR	32	10	728 598 414	-	0.033	50	35	54.0	3,7
50	BCF, IR	40	10	728 598 416	-	0.061	64	48	61.0	4,6
63	BCF, IR	50	10	728 598 418	-	0.093	78	60	67.0	5,8

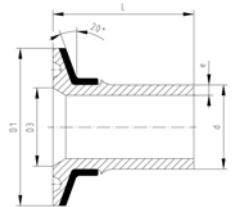

Sanitary Adaptor Connection to 3A Standard

Model:

- Polypropylene, Material Type: PP-R (unpigmented)
- Stainless steel reinforcement ring
- Bead and Crevice Free weldable with the new BCF® Plus fusion machine
- Infrared-(IR Plus®) compatible. Please choose fusion parameters: PP-n (PP-R)

* Without stainless steel reinforcement ring

d [mm]	FM	Inch	PN	Code	SP	kg	D1 [mm]	D3 [mm]	L [mm]	e [mm]
*20	BCF, IR	3/4	10	728 598 207	-	0.006	25	16	49.0	1,9
25	BCF, IR	1	10	728 598 209	-	0.032	50	22	49.5	2,3
32	BCF, IR	1 1/2	10	728 598 213	-	0.032	50	35	53.0	2,9
40	BCF, IR	1 1/2	10	728 598 215	-	0.033	50	35	54.0	3,7
50	BCF, IR	2	10	728 598 217	-	0.061	64	48	61.0	4,6
63	BCF, IR	2 1/2	10	728 598 219	-	0.093	78	60	67.0	5,8

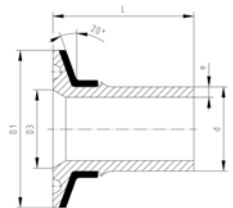

Sanitary Adaptor Connection to Membrane Manometer

Model:

- Polypropylene, Material Type: PP-R (unpigmented)
- Stainless steel reinforcement ring
- Bead and Crevice Free weldable with the new BCF® Plus fusion machine
- Infrared-(IR Plus®) compatible. Please choose fusion parameters: PP-n (PP-R)

d [mm]	FM	DN [mm]	PN	Code	SP	kg	e [mm]	D1 [mm]	D3 [mm]	L [mm]
20	BCF, IR	15	10	728 598 516	-	0.029	1,9	50	34	49
25	BCF, IR	20	10	728 598 518	-	0.031	2,3	50	34	50
32	BCF, IR	25	10	728 598 520	-	0.032	2,9	50	34	53

Butt Fusion Unions

Sanitary Union, SDR11

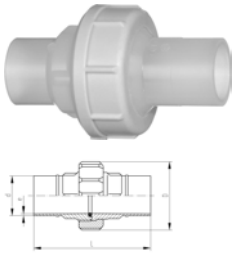

Model:

- Polypropylene, Material Type: PP-R (unpigmented)
- Bead and Crevice Free weldable with the new BCF® Plus fusion machine
- Infrared-(IR Plus®) compatible. Please choose fusion parameters: PP-n (PP-R)
- FDA compliant

d [mm]	FM	EPDM Code	FPM Code	SP	kg	D [mm]	L [mm]	L1 [mm]	L2 [mm]	e [mm]
20	BCF, IR	728 518 526	728 528 526	-	0.046	48	107	53	25	1,9
25	BCF, IR	728 518 527	728 528 527	-	0.074	58	113	56	25	2,3
32	BCF, IR	728 518 528	728 528 528	-	0.102	65	119	59	25	2,9
40	BCF, IR	728 518 529	728 528 529	-	0.169	79	126	63	25	3,7
50	BCF, IR	728 518 530	728 528 530	-	0.023	91	131	65	25	4,6
63	BCF, IR	728 518 531	728 528 531	-	0.382	111	137	68	25	5,8

Union End IR, SDR11

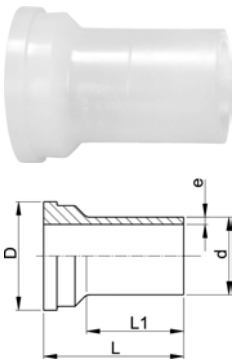

Model:

- Material: Polypropylene-Natural, Material Type: PP-R (unpigmented)
- Bead and Crevice Free weldable with the new BCF® Plus fusion machine
- Infrared-(IR Plus®) compatible. Please choose fusion parameters: PP-n (PP-R)
- Conventional butt-welding according to DVS 2207 part 1

d [mm]	PN	FM	Code	SP	kg	D [mm]	L [mm]	L1 [mm]	e [mm]
20	10	BCF, IR	728 608 506	-	0.009	30	53	35	1,9
25	10	BCF, IR	728 608 507	-	0.013	39	56	36	2,3
32	10	BCF, IR	728 608 508	-	0.016	45	59	38	2,9
40	10	BCF, IR	728 608 509	-	0.035	57	63	39	3,7
50	10	BCF, IR	728 608 510	-	0.054	63	65	41	4,6
63	10	BCF, IR	728 608 511	-	0.092	78	69	43	5,8

Valve end 546, SDR11

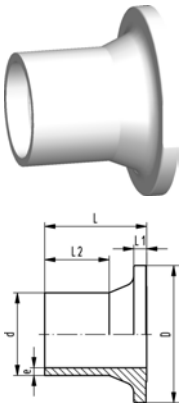

Model:

- Material: Polypropylene-Natural, Material Type: PP-R (unpigmented)
- Bead and Crevice Free weldable with the new BCF® Plus fusion machine
- Infrared-(IR Plus®) compatible. Please choose fusion parameters: PP-n (PP-R)
- Conventional butt-welding according to DVS 2207 part 1

d [mm]	FM	Code	SP	kg	D [mm]	L [mm]	L1 [mm]	L2 [mm]	e [mm]
20	BCF, IR	168 480 260	-	0.007	38	37	4	25	1,9
25	BCF, IR	168 480 261	-	0.011	44	39	5	25	2,3
32	BCF, IR	168 480 262	-	0.017	53	40	5	25	2,9
40	BCF, IR	168 480 263	-	0.030	65	43	5	25	3,7
50	BCF, IR	168 480 264	-	0.053	77	51	6	25	4,6
63	BCF, IR	168 480 265	-	0.093	99	60	7	28	5,8

Diaphragm valves

PROGEF® Natural Diaphragm valve type 315 With butt fusion spigots S5/SDR11

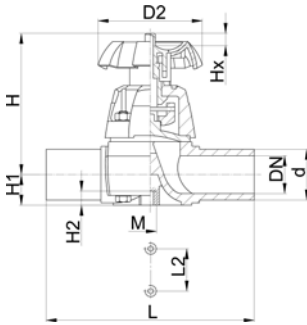

Model:

- Bead and Crevice Free weldable with the new BCF®-n fusion machine
- Conventional butt fusion and (IR Plus®) compatible
- PTFE with EPDM supporting diaphragm: FDA conform

Option:

- Handwheel with built in locking mechanism

d [mm]	DN [mm]	PN [bar]	kv-value ($\Delta p=1$ bar) [l/min]	PTFE with EPDM supporting diaphragm Code	kg
20	15	10.0 / 6.0	72	168 315 532	0.312
25	20	10.0 / 6.0	137	168 315 533	0.494
32	25	10.0 / 6.0	207	168 315 534	0.660
40	32	10.0 / 6.0	354	168 315 535	0.857
50	40	10.0 / 6.0	517	168 315 536	1.155
63	50	10.0 / 6.0	713	168 315 537	2.018

d [mm]	D2 [mm]	H [mm]	H1 [mm]	H2 [mm]	L [mm]	L2 [mm]	M
20	80	90	14	12	124	25	M6
25	80	101	18	12	144	25	M6
32	94	117	22	12	154	25	M6
40	117	127	26	15	174	45	M8
50	117	139	32	15	194	45	M8
63	152	172	39	15	223	45	M8

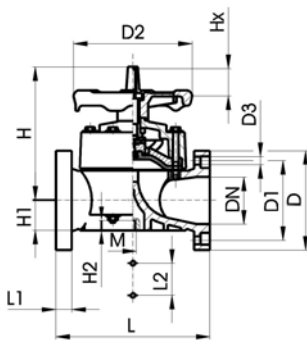

DN 80-100

PROGEF® Natural Diaphragm valve type 317 With fixed flanges PP-n

Model:

- With Fixed Flanges PP-n (natural), jointing face flat
- Overall length EN 558-1
- Connecting dimensions: ¹⁾ ISO 7005 and ²⁾ ANSI B 16.5

d [mm]	DN [mm]	Inch	PN	kv-value ($\Delta p=1$ bar) [l/min]	Connection dimensions	EPDM Code	kg	
¹ 90	80	3	10	1700	ISO + ANSI	168 317 324	8.000	
¹ 110	100	4	10	2700		ISO	168 317 025	11.000
² 110	100	4	10	2700		ANSI	168 317 325	11.000

d [mm]	D [mm]	D1 [mm]	D2 [mm]	D3 [mm]	L [mm]	L1 [mm]	L2 [mm]	H [mm]	H1 [mm]	H2 [mm]	M	Lift = Hx [mm]
¹ 90	200	160	270	19	310	35	120	265	57	23	M12	40
¹ 110	225	180	270	18	350	38	120	304	69	23	M12	50
² 110	225	190	270	19	350	38	120	304	69	23	M12	50



PROGEF® Natural Diaphragm valve type 319 With butt fusion spigots SDR11

Model:

- Valve body injection molded
- Minimized static zone (dead leg)
- Compact design
- Bead and Crevice Free weldable with the new BCF®-n fusion machine
- Conventional butt fusion and (IR Plus®) compatible

Option:

- Handwheel with built in locking mechanism

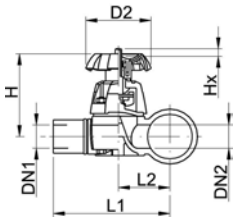
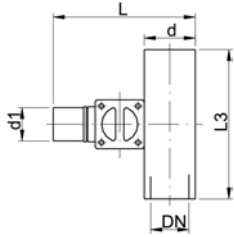

d	d1	DN	DN1	DN2	PN	kv-value ($\Delta p=1$ bar)	EPDM Code	kg	
[mm]	[mm]	[mm]	[mm]	[mm]		[l/min]			
20	20	15	15	15	10	47	168 319 401	0.274	
25	20	20	15	20	10	69	168 319 403	0.361	
25	25	20	20	20	10	91	168 319 404	0.361	
32	20	25	15	25	10	86	168 319 407	0.602	
32	25	25	20	25	10	126	168 319 408	0.601	
32	32	25	25	25	10	156	168 319 409	0.596	
40	20	32	15	25	10	84	168 319 412	0.634	
50	20	40	15	25	10	82	168 319 418	0.677	
50	25	40	20	25	10	124	168 319 419	0.676	
50	32	40	25	25	10	159	168 319 420	0.676	
63	20	50	15	25	10	81	168 319 425	0.750	
63	25	50	20	25	10	115	168 319 426	0.749	
63	32	50	25	25	10	156	168 319 427	0.746	
90	20	80	15	25	6	88	168 319 441	0.871	
90	25	80	20	25	6	133	168 319 442	1.062	
90	32	80	25	25	6	162	168 319 443	0.907	
90	50	80	40	50	6	504	168 319 445	2.285	
90	63	80	50	50	6	530	168 319 446	2.285	
110	20	100	15	25	6	89	168 319 451	0.888	
110	25	100	20	25	6	123	168 319 452	0.887	
110	32	100	25	25	6	159	168 319 453	0.886	
110	50	100	40	50	6	503	168 319 455	2.400	
110	63	100	50	50	6	543	168 319 456	2.426	

d	D2	H	L	L1	L2	L3	
[mm]	[mm]	[mm]	[mm]	[mm]	[mm]	[mm]	
20	80	83	106	96	30	140	
25	80	91	121	108	36	150	
25	80	91	121	108	36	150	
32	94	105	137	120	43	160	
32	94	105	137	120	43	160	
32	94	105	137	120	43	160	
40	94	105	149	128	51	180	
50	94	105	159	134	57	180	
50	94	105	159	134	57	180	
50	94	105	159	134	57	180	
63	94	105	175	144	67	180	
63	94	105	175	144	67	180	
63	94	105	175	144	67	180	
90	94	105	204	159	82	160	
90	94	105	204	159	82	160	
90	94	105	204	159	82	160	
90	152	151	252	207	95	220	
90	152	151	252	207	95	220	
110	94	105	226	171	94	160	
110	94	105	226	171	94	160	
110	94	105	226	171	94	160	
110	152	151	274	219	107	220	
110	152	151	274	219	107	220	



PROGEF® Natural Diaphragm valve type 319 With butt fusion spigots SDR11-11

Model:

- Valve body injection molded
- Minimized static zone (dead leg)
- Compact design
- Bead and Crevice Free weldable with the new BCF®-n fusion machine
- Conventional butt fusion and (IR Plus®) compatible

Option:

- Handwheel with built in locking mechanism

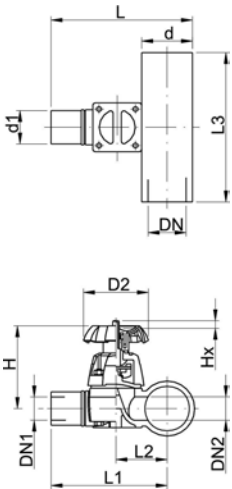





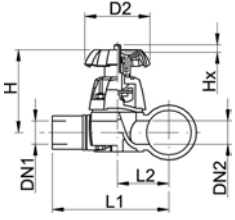
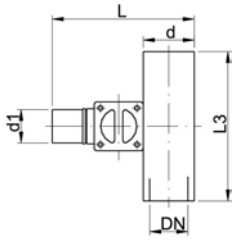



d [mm]	d1 [mm]	DN1 [mm]	DN [mm]	DN2 [mm]	PN	kv-value ($\Delta p=1$ bar) [l/min]	PTFE with EPDM supporting diaphragm Code	kg
20	20	15	15	15	6	47	168 319 501	0.312
25	20	15	20	20	6	69	168 319 503	0.462
25	25	20	20	20	6	91	168 319 504	0.465
32	20	25	25	25	6	86	168 319 507	0.602
32	25	20	25	25	6	126	168 319 508	0.624
32	32	25	25	25	6	156	168 319 509	0.619
40	20	15	32	25	6	84	168 319 512	0.304
40	25	16	32	20	6	124	168 319 513	
32	32	20	32	20	6	161	168 319 514	
32	40	25	32	25	6	250	168 319 515	
50	20	15	40	25	6	82	168 319 518	0.702
50	25	20	40	25	6	124	168 319 519	0.701
50	32	25	40	25	6	159	168 319 520	0.701
63	20	15	50	25	6	81	168 319 525	0.750
63	25	20	50	25	6	115	168 319 526	0.775
63	32	25	50	25	6	156	168 319 527	0.771
90	20	15	80	25	6	88	168 319 541	0.878
90	25	20	80	25	6	133	168 319 542	1.277
90	32	25	80	25	6	162	168 319 543	0.876
90	50	40	80	50	6	504	168 319 545	2.300
90	63	50	80	50	6	530	168 319 546	2.300
110	20	15	100	25	6	89	168 319 551	0.897
110	25	20	100	25	6	123	168 319 552	0.897
110	32	25	100	25	6	159	168 319 553	0.891
110	50	40	100	50	6	503	168 319 555	2.488
110	63	50	100	50	6	543	168 319 556	2.433

d [mm]	D2 [mm]	H [mm]	L [mm]	L1 [mm]	L2 [mm]	L3 [mm]
20	80	83	106	96	30	140
25	80	91	121	108	36	150
25	80	91	121	108	36	150
32	94	105	137	120	43	160
32	94	105	137	120	43	160
32	94	105	137	120	43	160
40	94	105	149	128	51	180
40	94	116	149	128	51	180
32	94	116	149	128	51	180
32	117	127	174	153	56	190
50	94	105	159	134	57	180
50	94	105	159	134	57	180
50	94	105	159	134	57	180
63	94	105	175	144	67	180
63	94	105	175	144	67	180



d	D2	H	L	L1	L2	L3	
[mm]	[mm]	[mm]	[mm]	[mm]	[mm]	[mm]	
63	94	105	175	144	67	180	
90	94	105	204	159	82	160	
90	94	105	204	159	82	160	
90	94	105	204	159	82	160	
90	152	151	252	207	95	220	
90	152	151	252	207	95	220	
110	94	105	226	171	94	160	
110	94	105	226	171	94	160	
110	94	105	226	171	94	160	
110	152	151	274	219	107	220	
110	152	151	274	219	107	220	

PROGEF® Plus

		Page
	Pipes	178
	Butt Fusion Fittings	179
	Socket Fusion	184
	Unions for Butt Fusion	185
 DN10/15 - 50	Ball valves	186
	Diaphragm valves	189
	Butterfly valves	194
	Ball check valves	197
	Seals	199

Pipes

PP-H S5/SDR11 (PN10)

Model:

- Material: Polypropylene (PP-H)
- DIN 8077 / 8078 - DIBT Z-40.23-4
- Closed with caps and double bagged (LDPE-foil)
- Pipes are closed with caps directly after extrusion
- Colour: RAL 7032 gravel grey
- 5m pipe lengths

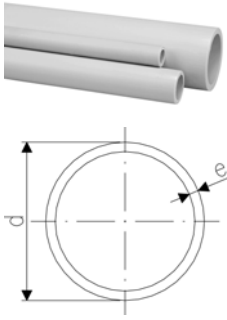

d [mm]	Code	kg/m	e [mm]	
20	167 481 711	0.107	1,9	
25	167 481 712	0.164	2,3	
32	167 481 713	0.261	2,9	
40	167 481 714	0.412	3,7	
50	167 481 715	0.638	4,6	
63	167 481 716	1.010	5,8	
75	167 481 717	1.410	6,8	
90	167 481 718	2.030	8,2	
110	167 481 719	3.010	10,0	
125	167 481 720	3.910	11,4	
140	167 481 721	4.870	12,7	
160	167 481 722	6.380	14,6	
180	167 481 723	8.070	16,4	
200	167 481 724	9.950	18,2	
225	167 481 725	12.600	20,5	
250	167 481 726	15.500	22,7	
280	167 481 727	19.400	25,4	
315	167 481 728	24.600	28,6	

Butt Fusion Fittings

Bend 90° S5/SDR11

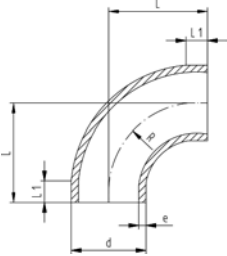

Model:

- Material: Polypropylene (PP-H)
- Conventional butt-welding according to DVS 2207 part 1
- IR = Infrared-(IR Plus®) compatible. Please choose fusion parameters: PP-H
- Cleaned and double bagged

d [mm]	FM	Code	SP	L [mm]	L1 [mm]	R [mm]	e [mm]
20	--	727 018 466	-	27	5	22	1,9
25	--	727 018 467	-	32	7	27	2,3
32	--	727 018 468	-	40	7	35	2,9
40	--	727 018 469	-	51	10	44	3,7
50	--	727 018 470	-	62	10	55	4,6
63	--	727 018 471	-	77	10	69	5,8
75	IR	727 018 662	-	100	20	90	6,8
90	IR	727 018 663	-	100	20	90	8,2
110	IR	727 018 664	-	141	25	130	10,0
125	IR	727 018 475	-	140	15	125	11,4
140	IR	727 018 476	-	155	15	140	12,7
160	IR	727 018 477	-	175	15	160	14,6
180	IR	727 018 478	-	195	15	180	16,4
200	IR	727 018 479	-	215	15	200	18,2
225	IR	727 018 480	-	245	20	225	20,5

Elbow 90°, S5/SDR11

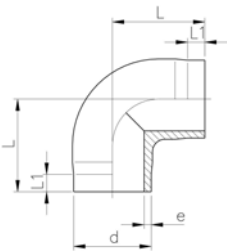

Model:

- Material: Polypropylene (PP-H)
- Conventional butt-welding according to DVS 2207 part 1
- IR = Infrared-(IR Plus®) compatible. Please choose fusion parameters: PP-H
- Cleaned and double bagged

d [mm]	FM	Code	SP	L [mm]	L1 [mm]	e [mm]
20	IR	727 108 581	-	38	25	1,9
25	IR	727 108 582	-	42	26	2,3
32	IR	727 108 583	-	46	27	2,9
40	IR	727 108 584	-	51	22	3,7
50	IR	727 108 585	-	58	23	4,6
63	IR	727 108 586	-	66	21	5,8



Elbow 45°, S5/SDR11

Model:

- Material: Polypropylene (PP-H)
- Conventional butt-welding according to DVS 2207 part 1
- IR = Infrared-(IR Plus®) compatible. Please choose fusion parameters: PP-H
- Cleaned and double bagged

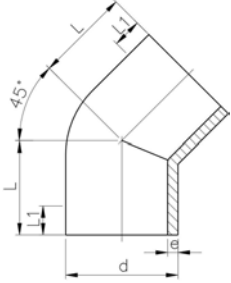

d [mm]	FM	Code	SP	L [mm]	L1 [mm]	e [mm]
20	IR	727 158 581	-	32	24	1,9
25	IR	727 158 582	-	34	25	2,3
32	IR	727 158 583	-	36	25	2,9
40	IR	727 158 584	-	39	25	3,7
50	IR	727 158 585	-	42	26	4,6
63	IR	727 158 586	-	47	29	5,8
75	IR	727 158 587	-	49	29	6,8
90	IR	727 158 588	-	57	34	8,2
110	IR	727 158 589	-	70	43	10,0
125	IR	727 158 590	-	79	48	11,4
140	IR	727 158 591	-	88	55	12,7
160	IR	727 158 592	-	100	60	14,6
200	IR	727 158 594	-	124	75	18,2
225	IR	727 158 595	-	140	85	20,5



Tee 90° equal, S5/SDR11

Model:

- Material: Polypropylene (PP-H)
- Conventional butt-welding according to DVS 2207 part 1
- IR = Infrared-(IR Plus®) compatible. Please choose fusion parameters: PP-H
- Cleaned and double bagged

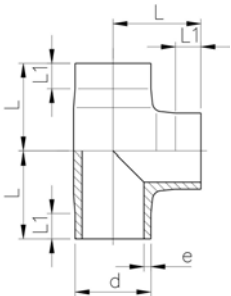

d [mm]	FM	Code	SP	L [mm]	L1 [mm]	e [mm]
20	IR	727 208 581	-	38	24	1,9
25	IR	727 208 582	-	42	26	2,3
32	IR	727 208 583	-	46	26	2,9
40	IR	727 208 584	-	51	23	3,7
50	IR	727 208 585	-	58	22	4,6
63	IR	727 208 586	-	66	20	5,8
75	IR	727 208 587	-	75	20	6,8
90	IR	727 208 588	-	90	20	8,2
110	IR	727 208 589	-	110	20	10,0
125	IR	727 208 590	-	125	25	11,4
140	IR	727 208 591	-	140	28	12,7
160	IR	727 208 592	-	160	28	14,6
180	IR	727 208 593	-	195	73	16,4
200	IR	727 208 594	-	200	35	18,2
225	IR	727 208 595	-	220	35	20,5



Flange Adaptor, S5/SDR11 Jointing face, combination serrated / flat

Model:

- Material: Polypropylene (PP-H)
- Conventional butt-welding according to DVS 2207 part 1
- IR = Infrared-(IR Plus®) compatible. Please choose fusion parameters: PP-H
- Suitable for flange connections to metric (**from d110 also to ANSI B16.5**)
- Do **not** use these flange adaptors when installing butterfly valves.
- Cleaned and double bagged

d [mm]	FM	Code	SP	D [mm]	D1 [mm]	L [mm]	L1 [mm]	L2 [mm]	e [mm]
20	IR	727 798 581	-	26	45	50	7	29	1,9
25	IR	727 798 582	-	32	58	52	9	27	2,3
32	IR	727 798 583	-	40	68	54	10	28	2,9
40	IR	727 798 584	-	49	78	55	11	25	3,7
50	IR	727 798 585	-	60	88	62	12	32	4,6
63	IR	727 798 586	-	75	102	68	14	38	5,8
75	IR	727 798 587	-	89	122	80	16	43	6,8
90	IR	727 798 588	-	105	138	80	17	41	8,2
110	IR	727 798 589	-	125	158	80	18	40	10,0
125	IR	727 798 590	-	132	158	82	25	35	11,4
140	IR	727 798 591	-	155	188	89	25	39	12,7
*160	IR	727 798 592	-	175	212	92	25	41	14,6
180	IR	727 798 593	-	182	212	80	30	50	16,4
*200	IR	727 798 594	-	232	268	100	32	34	18,2
*225	IR	727 798 595	-	235	268	100	32	36	20,5

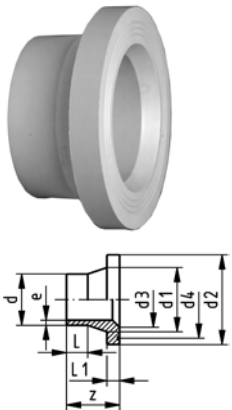

Special Flange Adaptor, S5/SDR11 Jointing face, combinatio serrated / flat

Model:

- Material: Polypropylene (PP-H)
- Conventional butt-welding according to DVS 2207 part 1
- IR = Infrared-(IR Plus®) compatible. Please choose fusion parameters: PP-H
- Suitable for butterfly valves
- Chamfered and ready for use
- Cleaned and double bagged

¹ PP-R

d [mm]	FM	Code	SP	D [mm]	D1 [mm]	D2 [mm]	L [mm]	L1 [mm]	L2 [mm]	e [mm]
75	IR	727 798 887	-	89	122	62	80	16	43	6,8
90	IR	727 798 888	-	105	138	82	80	17	41	8,2
110	IR	727 798 889	-	125	158	100	80	18	40	10,0
140	IR	727 798 891	-	155	188	126	89	25	39	12,7
160	IR	727 798 892	-	175	212	153	92	25	44	14,6
180	IR	727 798 893	-	182	212	154	80	30	50	16,4
200	IR	727 798 894	-	232	268	208	100	32	30	18,2
225	IR	727 798 895	-	235	268	204	100	32	35	20,5



Reducer, S5/SDR11

Model:

- Material: Polypropylene (PP-H)
- Conventional butt-welding according to DVS 2207 part 1
- IR = Infrared-(IR Plus®) compatible. Please choose fusion parameters: PP-H
- Cleaned and double bagged

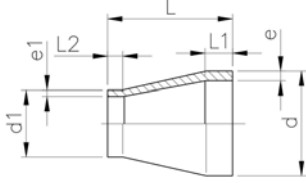

1 PP-R

d	d1	FM	Code	SP	L	L1	L2	e	e1
[mm]	[mm]				[mm]	[mm]	[mm]	[mm]	[mm]
25	20	IR	727 908 637	-	50	20	20	2,3	1,9
32	20	IR	727 908 642	-	50	20	20	2,9	1,9
32	25	IR	727 908 641	-	50	20	20	2,9	2,3
40	20	IR	727 908 648	-	58	20	23	3,7	1,9
40	25	IR	727 908 647	-	55	20	20	3,7	2,3
40	32	IR	727 908 646	-	55	20	20	3,7	2,9
50	25	IR	727 908 654	-	60	20	20	4,6	2,3
50	32	IR	727 908 653	-	60	20	20	4,6	2,9
50	40	IR	727 908 652	-	60	20	20	4,6	3,7
63	32	IR	727 908 660	-	65	20	20	5,8	2,9
63	40	IR	727 908 659	-	65	20	20	5,8	3,7
63	50	IR	727 908 658	-	65	20	20	5,8	4,6
75	40	IR	727 908 666	-	68	20	20	6,8	3,7
75	50	IR	727 908 665	-	65	20	20	6,8	4,6
75	63	IR	727 908 664	-	65	20	20	6,8	5,8
90	63	IR	727 908 671	-	75	22	19	8,2	5,8
90	75	IR	727 908 670	-	75	21	19	8,2	6,8
110	75	IR	727 908 677	-	90	28	18	10,0	6,8
110	90	IR	727 908 676	-	90	28	20	10,0	8,2
125	110	IR	727 908 680	-	100	31	30	11,4	10,0
140	110	IR	727 908 685	-	110	33	29	12,7	10,0
140	125	IR	727 908 684	-	110	34	30	12,7	11,4
160	110	IR	727 908 690	-	120	38	27	14,6	10,0
160	140	IR	727 908 688	-	120	40	35	14,6	12,7
180	110	IR	727 908 955	-	157	45	28	16,4	10,0
180	160	IR	727 908 952	-	136	45	40	16,4	14,6
200	160	IR	727 908 692	-	145	50	40	18,2	14,6
200	180	IR	727 908 693	-	151	50	45	18,2	16,4
225	110	IR	727 908 695	-	160	55	35	20,5	10,0
225	160	IR	727 908 696	-	160	55	40	20,5	14,6
225	200	IR	727 908 697	-	160	55	50	20,5	18,2

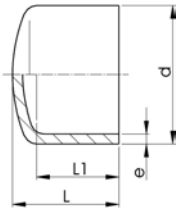

End Cap, S5/SDR11

Model:

- Material: Polypropylene (PP-H)
- Conventional butt-welding according to DVS 2207 part 1
- IR = Infrared-(IR Plus®) compatible. Please choose fusion parameters: PP-H
- Cleaned and double bagged

¹ PP-R

d [mm]	FM	Code	SP	L [mm]	L1 [mm]	e [mm]
20	IR	727 968 981	-	45	35	1,9
25	IR	727 968 982	-	52	40	2,3
32	IR	727 968 983	-	58	44	2,9
40	IR	727 968 984	-	67	50	3,7
50	IR	727 968 985	-	75	55	4,6
63	IR	727 968 986	-	85	62	5,8
75	IR	727 968 987	-	95	63	6,8
90	IR	727 968 988	-	110	79	8,2
110	IR	727 968 989	-	127	88	10,0
125	IR	727 968 990	-	138	102	11,4
140	IR	727 968 991	-	144	106	12,7
160	IR	727 968 992	-	154	109	14,6
180	IR	727 968 993	-	191	141	16,4
200	IR	727 968 994	-	181	127	18,2
225	IR	727 968 995	-	211	141	20,5

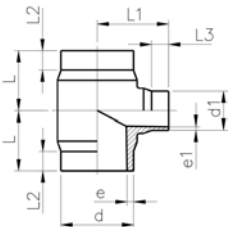

Tee 90° reducing, S5/SDR11

Model:

- Material: Polypropylene (PP-H)
- Conventional butt-welding according to DVS 2207 part 1
- IR = Infrared-(IR Plus®) compatible. Please choose fusion parameters: PP-H
- Cleaned and double bagged

d [mm]	d1 [mm]	FM	Code	SP	L [mm]	L1 [mm]	L2 [mm]	L3 [mm]	e [mm]	e1 [mm]
63	32	IR	727 208 251	-	65	70	25	25	5,8	2,9
63	50	IR	727 208 252	-	65	70	25	25	5,8	4,6
75	32	IR	727 208 253	-	70	75	25	25	6,8	2,9
75	50	IR	727 208 254	-	70	75	25	25	6,8	4,6
75	63	IR	727 208 255	-	70	75	25	25	6,8	5,8
90	50	IR	727 208 257	-	80	85	25	25	8,2	4,6
90	63	IR	727 208 258	-	80	85	25	25	8,2	5,8
90	75	IR	727 208 259	-	80	85	25	25	8,2	6,8
110	32	IR	727 208 260	-	90	95	30	25	10,0	2,9
110	50	IR	727 208 261	-	90	95	30	25	10,0	4,6
110	63	IR	727 208 262	-	90	95	30	25	10,0	5,8
110	75	IR	727 208 263	-	90	95	30	25	10,0	6,8
110	90	IR	727 208 264	-	90	95	30	25	10,0	8,2
160	63	IR	727 208 271	-	142	135	50	30	14,6	5,8
160	75	IR	727 208 272	-	142	135	50	30	14,6	6,8
160	90	IR	727 208 273	-	142	135	50	30	14,6	8,2
160	110	IR	727 208 274	-	142	135	50	30	14,6	10,0
225	90	IR	727 208 288	-	155	165	40	30	20,5	8,2
225	110	IR	727 208 289	-	155	165	40	30	20,5	10,0
225	160	IR	727 208 291	-	155	165	40	30	20,5	14,6

Socket Fusion

EPDM 27 51 02
FPM 27 52 02

Union

Model:

- Material: Polypropylene (PP-H)
- With fusion sockets metric
- D75-110 with new thread geometry, now rated PN10 up to d110
- Jointing face: with O-Ring
- Cleaned and double bagged

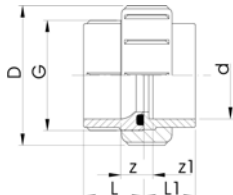

d [mm]	PN	EPDM Code	FPM Code	SP
16	10	727 510 255	727 520 255	-
20	10	727 510 256	727 520 256	-
25	10	727 510 257	727 520 257	-
32	10	727 510 258	727 520 258	-
40	10	727 510 259	727 520 259	-
50	10	727 510 260	727 520 260	-
63	10	727 510 261	727 520 261	-
75	10	727 510 272	727 520 272	-
90	10	727 510 273	727 520 273	-
110	10	727 510 274	727 520 274	-

d [mm]	D [mm]	G [inch]	L [mm]	L1 [mm]	z [mm]	z1 [mm]	O-Ring EPDM	O-Ring FPM	Size
16	35	3/4	24	18	5	11	748.413.005	749.413.005	15,54 x 2,62
20	48	1	26	19	5	12	748.413.006	749.413.006	20,22 x 3,53
25	58	1 1/4	28	21	5	12	748.413.007	749.413.007	28,17 x 3,53
32	65	1 1/2	30	23	5	12	748.413.008	749.413.008	32,93 x 3,53
40	79	2	34	25	5	14	748.413.009	749.413.009	40,65 x 5,54
50	91	2 1/4	39	28	5	16	748.413.010	749.413.010	47,00 x 5,34
63	111	2 3/4	47	32	5	20	748.413.011	749.413.011	59,69 x 5,34
75	135	S107,5x3,6	51	36	5	20	748.413.014	749.413.014	81,92 x 5,34
90	158	S127,5x3,6	55	42	7	20	748.413.015	749.413.015	101,00 x 5,34
110	188	S152,5x3,6	54	49	7	12	748.413.016	748.413.016	120,00 x 6,99

Unions for Butt Fusion

EPDM 27 51 86
FPM 27 52 86

Union, S5/SDR11

Model:

- Material: Polypropylene (PP-H)
- With butt fusion ends
- IR = Infrared-(IR Plus[®]) compatible. Please choose fusion parameters: PP-H
- Cleaned and double bagged

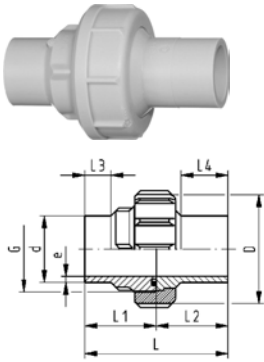

d [mm]	D [mm]	FM	EPDM Code	FPM Code	SP
20	48	IR	727 518 606	727 528 606	-
25	58	IR	727 518 607	727 528 607	-
32	65	IR	727 518 608	727 528 608	-
40	79	IR	727 518 609	727 528 609	-
50	91	IR	727 518 610	727 528 610	-
63	111	IR	727 518 611	727 528 611	-
75	135	IR	727 518 612	727 528 612	-
90	135	IR	727 518 613	727 528 613	-
110	158	IR	727 518 614	727 528 614	-

d [mm]	G [inch]	L [mm]	L1 [mm]	L2 [mm]	L3 [mm]	e [mm]	O-Ring EPDM	O-Ring FPM	Size
20	1	107	54	53	26	1,9	748.413.006	749.413.006	20,22 x 3,53
25	1 1/4	113	57	56	26	2,3	748.413.007	749.413.007	28,17 x 3,53
32	1 1/2	119	60	59	26	2,9	748.413.008	749.413.008	32,93 x 3,53
40	2	126	63	63	26	3,7	748.413.009	749.413.009	40,65 x 5,34
50	2 1/4	131	66	66	26	4,6	748.413.010	749.413.010	47,00 x 5,34
63	2 3/4	137	69	68	26	5,8	748.413.011	749.413.011	59,69 x 5,34
75	S107,5x3,6	132	66	66	24	6,8	748.413.013	749.413.013	69,22 x 5,34
90	S107,5x3,6	131	66	66	24	8,2	748.413.014	749.413.014	81,92 x 5,34
110	S127,5x3,6	131	66	66	25	10,0	748.413.015	749.413.015	101,00 x 5,34

Ball valves

Ball Valve Type 546, PP-H SF with mounting inserts With fusion sockets metric

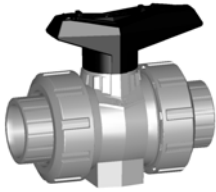

DN10/15 - 50

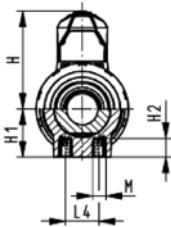
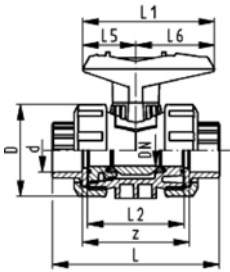

Model:

- Image and drawing DN65-100 please see **New product ball valve DN65-100**
- Silicon-free / paint-compatible
- For easy installation and removal
- z-dimension, valve end and valve nut are **not compatible** with type 346 (DN10/15-50) resp. type 370 (DN65-100)
- Integrated stainless steel mounting inserts
- Double bagged
- Ball seals PVDF

Option:

- Individual configuration of the valve (see form)
- Multifunctional module with integrated limit switches

d [mm]	DN [mm]	PN	kv-value ($\Delta p=1$ bar) [l/min]	EPDM Code	FPM Code
16	10	10	71	167 546 601	167 546 611
20	15	10	185	167 546 602	167 546 612
25	20	10	350	167 546 603	167 546 613
32	25	10	700	167 546 604	167 546 614
40	32	10	1000	167 546 605	167 546 615
50	40	10	1600	167 546 606	167 546 616
63	50	10	3100	167 546 607	167 546 617

d [mm]	D [mm]	H [mm]	H1 [mm]	H2 [mm]	L [mm]	L1 [mm]	L2 [mm]	L4 [mm]	L5 [mm]	L6 [mm]	M	z [mm]
16	50	57	27	12	93	77	56	25	32	45	M6	67
20	50	57	27	12	95	77	56	25	32	45	M6	66
25	58	67	30	12	108	97	65	25	39	58	M6	77
32	68	73	36	12	118	97	71	25	39	58	M6	83
40	84	90	44	15	137	128	85	45	54	74	M8	99
50	97	97	51	15	147	128	89	45	54	74	M8	105
63	124	116	64	15	168	152	101	45	66	87	M8	117

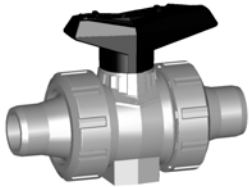

DN10/15 - 50

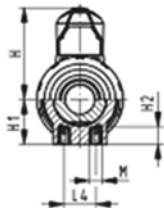
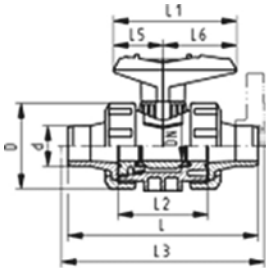

Ball Valve Type 546, PP-H SF with mounting inserts With socket fusion spigots metric

Model:

- Image and drawing DN65-100 please see **New product ball valve DN65-100**
- Silicon-free / paint-compatible
- For easy installation and removal
- z-dimension, valve end and valve nut are **not compatible** with type 346 (DN10/15-50) resp. type 370 (DN65-100)
- Integrated stainless steel mounting inserts
- Double bagged
- Ball seals PVDF

Option:

- Individual configuration of the valve (see form)
- Multifunctional module with integrated limit switches

d [mm]	DN [mm]	PN	kv-value ($\Delta p=1$ bar) [l/min]	EPDM Code	FPM Code
16	10	10	71	167 546 621	167 546 631
20	15	10	185	167 546 622	167 546 632
25	20	10	350	167 546 623	167 546 633
32	25	10	700	167 546 624	167 546 634
40	32	10	1000	167 546 625	167 546 635
50	40	10	1600	167 546 626	167 546 636
63	50	10	3100	167 546 627	167 546 637

d [mm]	D [mm]	H [mm]	H1 [mm]	H2 [mm]	L [mm]	L1 [mm]	L2 [mm]	L3 [mm]	L4 [mm]	L5 [mm]	L6 [mm]	M
16	50	57	27	12	110	77	56		25	32	45	M6
20	50	57	27	12	120	77	56	130	25	32	45	M6
25	58	67	30	12	139	97	65	150	25	39	58	M6
32	68	73	36	12	150	97	71	160	25	39	58	M6
40	84	90	44	15	170	128	85	180	45	54	74	M8
50	97	97	51	15	190	128	89	200	45	54	74	M8
63	124	116	64	15	220	152	101	230	45	66	87	M8

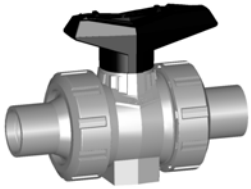

DN10/15 - 50

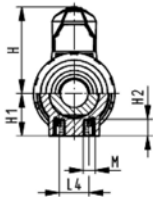
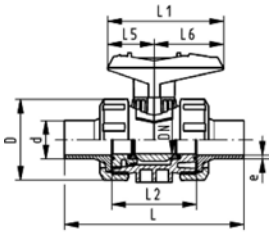

Ball Valve Type 546, PP-H SF with mounting inserts With butt fusion spigots IR-Plus SDR11 metric

Model:

- Image and drawing DN65-100 please see **New product ball valve DN65-100**
- Silicon-free / paint-compatible
- For easy installation and removal
- z-dimension, valve end and valve nut are **not compatible** with type 346 (DN10/15-50) resp. type 370 (DN65-100)
- Integrated stainless steel mounting inserts
- Double bagged
- Ball seals PVDF

Option:

- Individual configuration of the valve (see form)
- Multifunctional module with integrated limit switches

d [mm]	DN [mm]	PN	kv-value ($\Delta p=1$ bar) [l/min]	EPDM Code	FPM Code
20	15	10	185	167 546 662	167 546 672
25	20	10	350	167 546 663	167 546 673
32	25	10	700	167 546 664	167 546 674
40	32	10	1000	167 546 665	167 546 675
50	40	10	1600	167 546 666	167 546 676
63	50	10	3100	167 546 667	167 546 677

d [mm]	D [mm]	H [mm]	H1 [mm]	H2 [mm]	L [mm]	L1 [mm]	L2 [mm]	L4 [mm]	L5 [mm]	L6 [mm]	M	e [mm]
20	50	57	27	12	130	77	56	25	32	45	M6	1,9
25	58	67	30	12	143	97	65	25	39	58	M6	2,3
32	68	73	36	12	150	97	71	25	39	58	M6	3
40	84	90	44	15	171	128	85	45	54	74	M8	3,7
50	97	97	51	15	191	128	89	45	54	74	M8	4,6
63	124	116	64	15	220	152	101	45	66	87	M8	5,8

Diaphragm valves

PROGEF® PLUS silicon free Diaphragm valve type 314 PP-H SF With fusion sockets

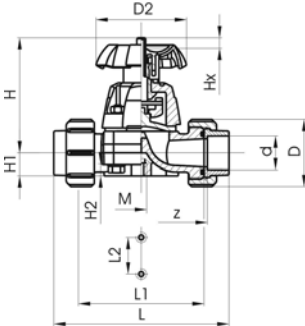

Model:

- Silicon-free / paint-compatible
- Double bagged

Option:

- Handwheel with built in locking mechanism

d [mm]	DN [mm]	PN	kv-value ($\Delta p=1$ bar) [l/min]	EPDM Code	PTFE with EPDM Supporting Diaphragm Code
20	15	10	72	167 314 477	167 314 492
25	20	10	137	167 314 478	167 314 493
32	25	10	207	167 314 479	167 314 494
40	32	10	354	167 314 480	167 314 495
50	40	10	517	167 314 481	167 314 496
63	50	10	713	167 314 482	167 314 497

d [mm]	z [mm]	D [mm]	D2 [mm]	L [mm]	L2 [mm]	H [mm]	H1 [mm]	H2 [mm]	M	Lift = Hx [mm]
20	100	47	80	128	25	90	14	12	M6	8
25	118	57	80	150	25	101	18	12	M6	11
32	126	64	94	162	25	117	21	12	M6	13
40	144	78	117	184	45	127	26	15	M8	16
50	164	89	117	210	45	139	33	15	M8	21
63	194	109	152	248	45	172	39	15	M8	28

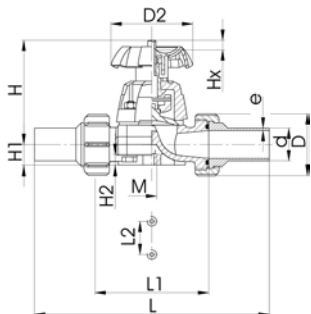

PROGEF® PLUS silicon free Diaphragm valve type 314 PP-H SF With butt fusion ends S5/SDR11

Model:

- Silicon-free / paint-compatible
- Double bagged

Option:

- Handwheel with built in locking mechanism

d [mm]	DN [mm]	PN	kv-value ($\Delta p=1$ bar) [l/min]	EPDM Code	PTFE with EPDM Supporting Diaphragm Code
20	15	10	72	167 314 577	167 314 592
25	20	10	137	167 314 578	167 314 593
32	25	10	207	167 314 579	167 314 594
40	32	10	354	167 314 580	167 314 595
50	40	10	517	167 314 581	167 314 596
63	50	10	713	167 314 582	167 314 597

d [mm]	D [mm]	D2 [mm]	L [mm]	L2 [mm]	H [mm]	H1 [mm]	H2 [mm]	M	Lift = Hx [mm]	e [mm]
20	47	80	196	25	90	14	12	M6	8	1,9
25	57	80	221	25	102	18	12	M6	11	2,3
32	64	94	234	25	119	21	12	M6	13	3
40	78	117	260	45	126	26	15	M8	16	3,7
50	89	117	284	45	139	33	15	M8	21	4,6
63	109	152	321	45	172	39	15	M8	28	5,8

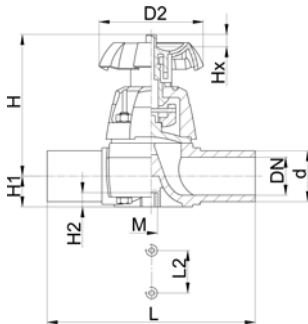

PROGEF® PLUS silicon free Diaphragm valve type 315 PP-H SF With butt fusion spigots S5/SDR11

Model:

- Silicon-free / paint-compatible
- Double bagged

Option:

- Handwheel with built in locking mechanism

d [mm]	DN [mm]	PN	kv-value ($\Delta p=1$ bar) [l/min]	EPDM Code	PTFE with EPDM supporting diaphragm Code
20	15	10	72	167 315 577	167 315 562
25	20	10	137	167 315 578	167 315 563
32	25	10	207	167 315 579	167 315 564
40	32	10	354	167 315 580	167 315 565
50	40	10	517	167 315 581	167 315 566
63	50	10	713	167 315 582	167 315 567

d [mm]	D2 [mm]	H [mm]	H1 [mm]	H2 [mm]	L [mm]	L2 [mm]	M
20	80	90	14	12	124	25	M6
25	80	101	18	12	144	25	M6
32	94	117	22	12	154	25	M6
40	117	127	26	15	174	45	M8
50	117	139	32	15	194	45	M8
63	152	172	39	15	223	45	M8



PROGEF® PLUS silicone free Diaphragm valve type 317 PP-H SF

Model:

- Silicon-free / paint-compatible
- Double bagged
- Jointing surfaces: serrated or flat
- DN 15-65 with backing flange
- DN 80-150 with fixed flange
- Overall length according to EN 558-1
- Connecting dimensions: ISO 7005 / EN 1092 / DIN 2501 PN10 / BS4504

Option:

- Handwheel lockable DN15-65 (basic version not lockable)

* DN80 and DN150 fixed flanges metric and Inch ANSI B16.5

d [mm]	DN [mm]	Inch	PN	kv-value ($\Delta p=1$ bar) [l/min]	EPDM Code	PTFE with EPDM supporting diaphragm Code
20	15	½	10	72	167 317 212	167 317 227
25	20	¾	10	137	167 317 213	167 317 228
32	25	1	10	207	167 317 214	167 317 229
40	32	1 ¼	10	354	167 317 215	167 317 230
50	40	1 ½	10	517	167 317 216	167 317 231
63	50	2	10	713	167 317 217	167 317 232
75	65	2 ½	10	992	167 317 218	167 317 233
*90	80	3	10	1700	167 317 129	167 317 144
*110	100	4	10	2700	167 317 130	167 317 145
*160	150	6	7	6033	167 317 132	167 317 147

d [mm]	D [mm]	D1 [mm]	D2 [mm]	D3 [mm]	L [mm]	L1 [mm]	L2 [mm]	L3 [mm]	H [mm]	H1 [mm]	H2 [mm]	M	AL	Lift = Hx [mm]
20	95	65	80	14	130		25		90	14	12	M6	4	7
25	105	75	80	14	150		25		101	18	12	M6	4	10
32	115	85	94	14	160		25		117	22	12	M6	4	12
40	140	100	117	18	180		45		127	26	15	M8	4	16
50	150	110	117	18	200		45		139	32	15	M8	4	19
63	165	125	152	18	230		45		172	39	15	M8	4	27
75	185	145	152	18	290		70		210	46	15	M8	4	35
*90	200	160	270	18	310	35	120		265	57	23	M12	8	40
*110	225	180	270	18	350	38	120		304	69	23	M12	8	50
*160	282	241	400	23	480	29	100	200	437	108	23	M12	8	70

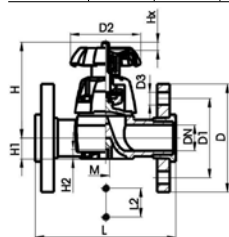

DN 15-65

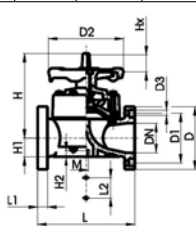

DN 80-100

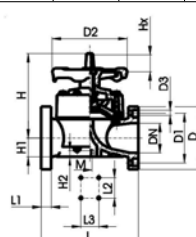

DN 150



PROGEF® PLUS silicone free Diaphragm valve type 319 PP-H SF Wit butt fusion spigots SDR11

Model:

- Silicon-free / paint-compatible
- Double bagged
- Compact design
- Minimized static zone (dead leg)

Option:

- Handwheel with built-in locking mechanism (standard version is nonlockable)

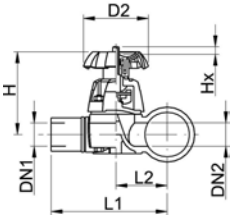
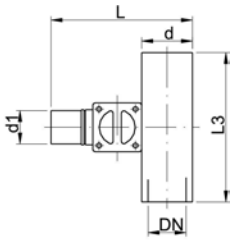

d [mm]	d1 [mm]	DN1 [mm]	DN [mm]	DN2 [mm]	PN	kv-value ($\Delta p=1$ bar) [l/min]	PTFE with EPDM supporting diaphragm Code
20	20	15	15	15	10	47	167 319 601
25	20	15	20	20	10	69	167 319 603
25	25	20	20	20	10	91	167 319 604
32	20	15	25	25	10	86	167 319 607
32	25	20	25	25	10	126	167 319 608
32	32	25	25	25	10	156	167 319 609
40	20	15	32	25	10	84	167 319 612
50	20	15	40	25	10	82	167 319 618
50	25	20	40	25	10	124	167 319 619
50	32	25	40	25	10	159	167 319 620
63	20	15	50	25	10	81	167 319 625
63	25	20	50	25	10	115	167 319 626
63	32	25	50	25	10	156	167 319 627
90	20	15	80	20	6	88	167 319 641
90	25	20	80	25	6	133	167 319 642
90	32	25	80	25	6	162	167 319 643
90	50	40	80	50	6	504	167 319 645
90	63	50	80	50	6	530	167 319 646
110	20	15	100	25	6	89	167 319 651
110	25	20	100	25	6	123	167 319 652
110	32	25	100	25	6	159	167 319 653
110	50	40	100	50	6	503	167 319 655
110	63	50	100	50	6	543	167 319 656

d [mm]	D2 [mm]	H [mm]	L [mm]	L1 [mm]	L2 [mm]	L3 [mm]
20	80	83	106	96	30	140
25	80	91	121	108	36	150
25	80	91	121	108	36	150
32	94	105	137	120	43	160
32	94	105	137	120	43	160
32	94	105	137	120	43	160
40	94	105	149	128	51	180
50	94	105	159	134	57	180
50	94	105	159	134	57	180
50	94	105	159	134	57	180
63	94	105	175	144	67	180
63	94	105	175	144	67	180
63	94	105	175	144	67	180
90	94	105	204	159	82	160
90	94	105	204	159	82	160
90	94	105	204	159	82	160
90	152	151	252	207	95	220
90	152	151	252	207	95	220
110	94	105	226	171	94	160
110	94	105	226	171	94	160
110	94	105	226	171	94	160
110	152	151	274	219	107	220
110	152	151	274	219	107	220

Butterfly valves

PROGEF® PLUS silicone free Butterfly valve type 567 PP-H SF Hand lever with ratchet settings



Model:

- Silicon-free / paint-compatible
- Connecting dimension: ISO 7005 PN 10, EN 1092 PN 10, DIN 2501 PN 10, ANSI B 16.5 Class 150, BS 1560: 1989, BS 4504, JIS B 2220
- Overall length according to EN 558-1, ISO 5752

Available from second quarter 2006

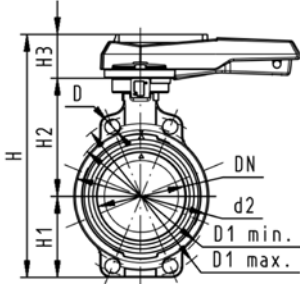

d [mm]	DN [mm]	Inch	PN	kv-value ($\Delta p=1$ bar) [l/min]	EPDM Code	FPM Code
63	50	2	10	1470	167 567 402	167 567 422
75	65	2 ½	10	2200	167 567 403	167 567 423
90	80	3	10	3000	167 567 404	167 567 424
110	100	4	10	6500	167 567 405	167 567 425
140	125	5	10	11500	167 567 406	167 567 426
160	150	6	10	16600	167 567 407	167 567 427
225	200	8	10	39600	167 567 408	167 567 428

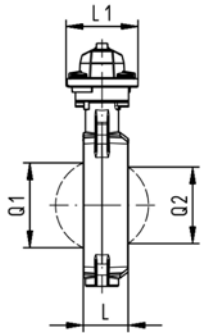

d [mm]	D [mm]	D1 min. [mm]	D1 max. [mm]	d2 [mm]	H [mm]	H1 [mm]	H2 [mm]	H3 [mm]	L [mm]	L1 [mm]	L2 [mm]	Q1 [mm]	Q2 [mm]
63	19	120.0	125.0	104	264	77	134	54	45	106	205	40	
75	19	139.7	145.0	115	277	83	140	54	46	106	205	54	35
90	19	150.0	160.0	131	289	89	146	54	49	106	205	67	50
110	19	175.0	190.5	161	325	104	167	55	56	106	255	88	74
140	23	210.0	215.9	187	352	117	181	55	64	106	255	113	97
160	24	241.3	241.3	215	373	130	189	55	72	106	255	139	123
225	23	290.0	295.0	267	435	158	210	67	73	140	408	178	169

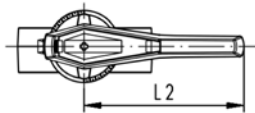



PROGEF® PLUS silicone free Lugstyle butterfly valve type 568 PP-H SF Hand lever with ratchet settings



Model:

- Silicon-free / paint-compatible
- Outer body in GGG-40.3 epoxy-coated
- Connecting dimension: ISO 7005 PN10, EN 1092 PN 10, DIN 2501 PN10
- Overall length according to EN 558-1, ISO 5752

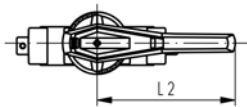
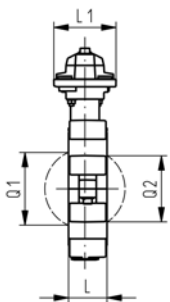
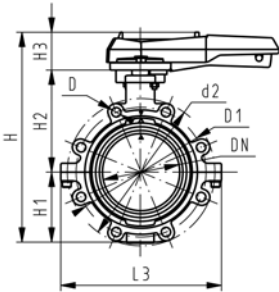

d [mm]	DN [mm]	Inch	PN	kv-value ($\Delta p=1$ bar) [l/min]	EPDM Code	FPM Code
63	50	2	10	1470	167 568 402	167 568 422
75	65	2 ½	10	2200	167 568 403	167 568 423
90	80	3	10	3000	167 568 404	167 568 424
110	100	4	10	6500	167 568 405	167 568 425
140	125	5	10	11500	167 568 406	167 568 426
160	150	6	10	16600	167 568 407	167 568 427
225	200	8	10	39600	167 568 408	167 568 428

d [mm]	d2 [mm]	D	D1 [mm]	H [mm]	H1 [mm]	H2 [mm]	H3 [mm]	L [mm]	L1 [mm]	L2 [mm]	L3 [mm]	Q1 [mm]	Q2 [mm]
63	150	M16	125	265	77	134	54	45	106	205	150	40	
75	170	M16	145	277	83	140	54	46	106	205	160	54	35
90	184	M16	160	289	89	146	54	49	106	205	205	67	50
110	216	M16	180	326	104	167	55	56	106	255	244	88	74
140	246	M16	210	353	117	181	55	64	106	255	272	113	97
160	273	M20	240	374	130	189	55	72	106	255	297	139	123
225	334	M20	295	435	158	210	67	73	140	408	360	178	169



PROGEF® PLUS silicone free Lugstyle butterfly valve 568 PP-H SF ANSI Hand lever with ratchet settings



Model:

- Silicon-free / paint-compatible
- Outer body in GGG-40.3 epoxy-coated
- Connecting dimension ANSI B 16.5 Class 150
- Overall length according to EN 558-1, ISO 5752

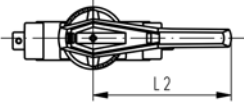
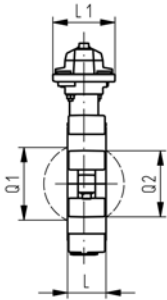
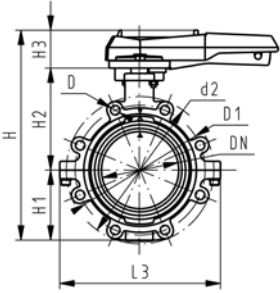

Inch	d [mm]	DN	PN	kv-value ($\Delta p=1$ bar) [l/min]	EPDM Code	FPM Code
2	63	50	10	1470	167 568 502	167 568 522
2 ½	75	65	10	2200	167 568 503	167 568 523
3	90	80	10	3000	167 568 504	167 568 524
4	110	100	10	6500	167 568 505	167 568 525
5	140	125	10	11500	167 568 506	167 568 526
6	160	150	10	16600	167 568 507	167 568 527
8	225	200	10	39600	167 568 508	167 568 528

Inch	d2 [mm]	D	D1 [mm]	H [mm]	H1 [mm]	H2 [mm]	H3 [mm]	L [mm]	L1 [mm]	L2 [mm]	L3 [mm]	Q1 [mm]	Q2 [mm]
2	150	UNC 5/8	121	265	77	134	54	45	106	205	150	40	
2 ½	170	UNC 5/8	138	277	83	140	54	46	106	205	160	54	35
3	177	UNC 5/8	152	289	89	146	54	49	106	205	175	67	50
4	216	UNC 5/8	191	326	104	167	55	56	106	255	244	88	74
5	246	UNC 3/4	216	353	117	181	55	64	106	255	272	113	97
6	273	UNC 3/4	241	374	130	189	55	72	106	255	297	139	123
8	334	UNC 3/4	298	435	158	210	67	73	140	408	360	178	169

Ball check valves

PROGEF® PLUS silicone free Ball check valve type 360 PP-H SF With fusion sockets

Model:

- Silicon-free / paint-compatible
- Double bagged
- For easy installation and removal

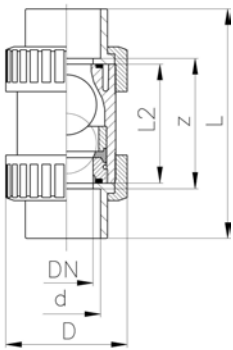

d [mm]	DN [mm]	PN	kv-value ($\Delta p=1$ bar) [l/min]	EPDM Code	FPM Code	D [mm]	L [mm]	L2 [mm]	z [mm]
16	10	10	170	167 360 601	167 360 611	46	98	62	72
20	15	10	150	167 360 602	167 360 612	46	101	62	73
25	20	10	330	167 360 603	167 360 613	56	119	74	87
32	25	10	390	167 360 604	167 360 614	67	130	78	94
40	32	10	710	167 360 605	167 360 615	82	149	88	109
50	40	10	900	167 360 606	167 360 616	98	162	94	118
63	50	10	1390	167 360 607	167 360 617	120	195	113	143

PROGEF® PLUS silicone free Ball check valve type 360 PP-H SF With socket fusion spigots

Model:

- Silicon-free / paint-compatible
- Double bagged
- For easy installation and removal
- Overall length EN 558-1

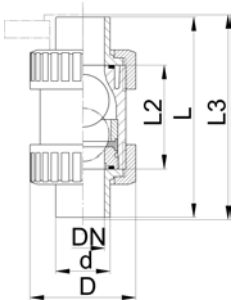

d [mm]	DN [mm]	PN	kv-value ($\Delta p=1$ bar) [l/min]	EPDM Code	FPM Code	D [mm]	L [mm]	L2 [mm]
16	10	10	170	167 360 621	167 360 631	46	109	62
20	15	10	150	167 360 622	167 360 632	46	119	62
25	20	10	330	167 360 623	167 360 633	56	140	74
32	25	10	390	167 360 624	167 360 634	67	150	78
40	32	10	710	167 360 625	167 360 635	82	171	88
50	40	10	900	167 360 626	167 360 636	97	191	94
63	50	10	1390	167 360 627	167 360 637	119	220	113



**PROGEF® PLUS silicone free
Ball check valve type 360 PP-H SF
With butt fusion ends S5/SDR11**

Model:

- Silicon-free / paint-compatible
- Double bagged
- For easy installation and removal

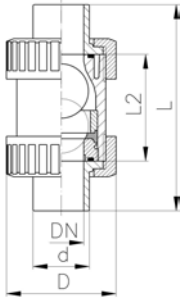

d [mm]	DN [mm]	PN	kv-value ($\Delta p=1$ bar) [l/min]	EPDM Code	FPM Code	D [mm]	L [mm]	L2 [mm]	
20	15	10	150	167 360 642	167 360 652	46	119	62	
25	20	10	330	167 360 643	167 360 653	56	140	74	
32	25	10	390	167 360 644	167 360 654	67	150	78	
40	32	10	710	167 360 645	167 360 655	82	171	88	
50	40	10	900	167 360 646	167 360 656	97	191	94	
63	50	10	1390	167 360 647	167 360 657	119	220	113	

Seals

EPDM 48 44 13
FPM 49 44 13

Flange Gasket for Flange Adaptors

Model:

- Hardness: 70° Shore **EPDM**, 75° Shore **FPM**
- Suitable for flange adaptors
- Cleaned and double bagged

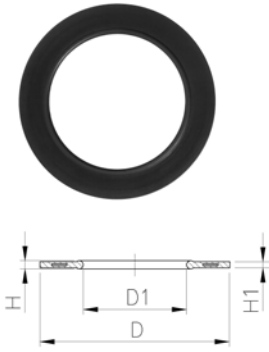

d [mm]	EPDM Code	FPM Code	SP	D [mm]	D1 [mm]	H [mm]	H1 [mm]
25	748 441 302	749 441 302	-	61	22	4	3
32	748 441 303	749 441 303	-	71	28	4	3
40	748 441 304	749 441 304	-	82	34	4	3
50	748 441 305	749 441 305	-	92	42	4	3
63	748 441 306	749 441 306	-	107	53	5	4
75	748 441 307	749 441 307	-	127	63	5	4
90	748 441 308	749 441 308	-	142	76	5	4
110	748 441 309	749 441 309	-	162	93	6	5
125	748 441 310	749 441 310	-	162	105	6	5
140	748 441 311	749 441 311	-	192	117	6	5
160	748 441 312	749 441 312	-	218	135	8	6
180	748 441 313	749 441 313	-	218	151	8	6
200	748 441 314	-	-	273	168	8	6
225	748 441 315	749 441 315	-	273	188	8	6

EPDM 48 41 30
FPM 49 41 30

O-Ring Gaskets

Model:

- Silicon-free / paint-compatible
- Fulfill chloroform contact test
- Hardness approx. 65° Shore
- For flange adaptors, jointing face with O-ring groove
- **Only standard packagings SP are delivered**

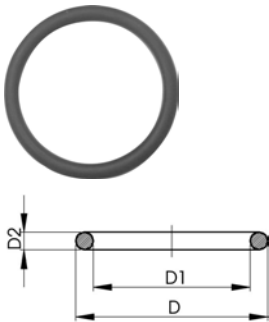

d [mm]	DN [mm]	EPDM Code	FPM Code	SP	D [mm]	D1 [mm]	D2 [mm]
20	15	748 413 001	749 413 001	2	30	23	4
25	20	748 413 007	749 413 007	2	35	28	4
32	25	748 413 002	749 413 002	2	43	36	4
40	32	748 413 003	749 413 003	2	55	44	5
50	40	748 413 012	749 413 012	2	64	53	5
63	50	748 413 013	749 413 013	2	80	69	5
75	65	748 413 014	749 413 014	2	93	82	5
90	80	748 413 015	749 413 015	2	112	101	5
110	100	748 413 016	749 413 016	2	134	120	7
125	100	748 413 017	749 413 017	2	149	136	7
140	125	748 413 018	749 413 018	2	166	152	7
160	150	748 413 019	749 413 019	2	191	177	7
200	200	748 413 163	749 413 163	2	136	222	7
225	200	748 413 022	749 413 022	2	255	241	7
250	250	748 413 182	749 413 182	2	280	266	7
280	250	748 413 173	749 413 173	2	305	292	7

Flat Gaskets





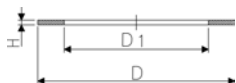



Model:

- Silicon-free / paint-compatible
- Fulfill chloroform contact test
- Hardness approx. 65° Shore
- For flange adaptors, jointing face serrated
- **Only standard packagings SP are delivered**



d [mm]	DN [mm]	FPM Code	SP	D [mm]	D1 [mm]	H [mm]	
16	10	-		27	16	2	
20	15	749 401 315	2	32	20	2	
25	20	749 401 316	2	39	25	2	
32	25	749 401 317	2	48	32	2	
40	32	749 401 318	2	59	40	3	
50	40	749 401 319	2	71	50	3	
63	50	749 401 320	2	88	63	3	
75	65	749 401 321	2	104	75	3	
90	80	749 401 322	2	123	90	3	
110	100	749 401 323	2	148	110	4	
125	100	749 401 324	2	168	125	4	
140	125	749 401 325	2	186	140	4	
160	150	749 401 326	2	211	160	4	
225	200	749 401 327	2	272	220	5	

Accessories and Machines

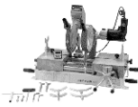
		Page
	Backing Flange, PP-V	202
	Backing Flanges, Galvanised Steel	206
	Backing Flanges, PP/Steel	210
	Fixed Flange PP	213
	Seals	214
	Pipe Clips metric	218
	Cleaner	223
	IR-63 Plus® Fusion Jointing Machine and Accessories	224
	IR-225 Plus® Fusion Jointing Machine and Accessories	225
	SG 160 Combined butt and socket fusion machine	226

Backing Flange, PP-V

27 70 04
27 70 05

Backing Flanges, PP-V for Butt Fusion Systems metric

Model:

- Modern full-plastic flange PP-GF (30 % glass-fibre reinforced)
- With V-groove which applies force evenly on collar
- With integrated bolt retainers as an assembly aid
- Connecting dimension: ISO 7005 PN 10, EN 1092 PN 10, DIN 2501 PN 10, BS 4504 PN 10

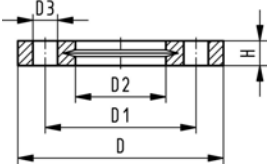

¹⁾ Suitable for socket- and butt fusion systems (no pictograph on flange)

d [mm]	Inch	DN [mm]	PN	Code	NRF	SP	kg	kg/m
'20		15	16	727 700 406	222 87 52	-	0.080	0.080
'25		20	16	727 700 407	222 87 53	-	0.100	0.100
'32		25	16	727 700 408	222 87 54	-	0.140	0.140
'40		32	16	727 700 409	222 87 55	-	0.220	0.220
'50		40	16	727 700 410	222 87 56	-	0.210	0.210
'63		50	16	727 700 411	222 87 57	-	0.380	0.380
'75		65	16	727 700 412	222 87 58	-	0.480	0.480
90		80	16	727 700 513	222 87 72	-	0.520	0.520
110		100	16	727 700 514	222 87 73	-	0.680	0.680
125		100	16	727 700 515	222 87 74	-	0.760	0.760
140		125	16	727 700 516	222 87 75	-	0.800	0.800
160	6	150	16	727 700 517	222 87 76	-	1.200	1.200
180		150	16	727 700 518	222 87 77	-	1.200	1.200
200	8	200	16	727 700 519	222 87 78	-	1.400	1.400
225	9	200	16	727 700 520	222 87 79	-	1.400	1.400
250		250	16	727 700 521	222 87 81	-	1.700	1.700
280		250	16	727 700 522	222 87 82	-	1.700	1.700
315		300	16	727 700 523	222 87 83	-	2.400	2.400

d [mm]	D [mm]	D1 [mm]	D2 [mm]	D3 [mm]	H [mm]	AL	SC
'20	95	65	28	14	16	4	M12
'25	105	75	34	14	17	4	M12
'32	115	85	42	14	18	4	M12
'40	140	100	51	18	20	4	M16
'50	150	110	62	18	22	4	M16
'63	165	125	78	18	24	4	M16
'75	185	145	92	18	26	4	M16
90	200	160	108	18	27	8	M16
110	220	180	128	18	28	8	M16
125	220	180	135	18	28	8	M16
140	250	210	158	18	30	8	M16
160	285	241	178	22	32	8	M20
180	285	240	188	22	32	8	M20
200	340	295	235	22	34	8	M20
225	340	295	238	22	34	8	M20
250	395	350	288	22	38	12	M20
280	395	350	294	22	38	12	M20
315	445	400	338	22	42	12	M20

27 70 04
27 70 05

Backing Flanges, PP-V for Socket Systems metric

Model:

- Modern full-plastic flange PP-GF (30 % glass-fibre reinforced)
- With V-groove which applies force evenly on collar
- With integrated bolt retainers as an assembly aid
- Connecting dimension: ISO 7005 PN 10, EN 1092 PN 10, DIN 2501 PN 10, BS 4504 PN 10

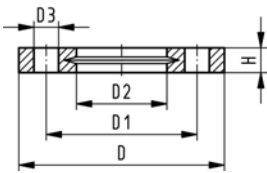

¹⁾ Suitable for socket- and butt fusion systems (no pictograph on flange)

d [mm]	Inch	DN [mm]	PN	Code	NRF	kg	kg/m
'20		15	16	727 700 406	222 87 52	0.080	0.080
'25		20	16	727 700 407	222 87 53	0.100	0.100
'32		25	16	727 700 408	222 87 54	0.140	0.140
'40		32	16	727 700 409	222 87 55	0.220	0.220
'50		40	16	727 700 410	222 87 56	0.210	0.210
'63		50	16	727 700 411	222 87 57	0.380	0.380
'75		65	16	727 700 412	222 87 58	0.480	0.480
90		80	16	727 700 413	222 87 92	0.520	0.520
110		100	16	727 700 414	222 87 93	0.680	0.680
140		125	16	727 700 416	222 87 94	0.800	0.800
160	6	150	16	727 700 417	222 87 95	1.200	1.200
200		200	16	727 700 419	222 87 99	1.500	1.500
225	9	200	16	727 700 420	222 87 96	1.400	1.400
250		250	16	727 700 421	222 88 01	1.700	1.700
280		250	16	727 700 422	222 87 97	1.700	1.700
315		300	16	727 700 423	222 87 98	2.400	2.400

d [mm]	D [mm]	D1 [mm]	D2 [mm]	D3 [mm]	H [mm]	AL	SC
'20	95	65	28	14	16	4	M12
'25	105	75	34	14	17	4	M12
'32	115	85	42	14	18	4	M12
'40	140	100	51	18	20	4	M16
'50	150	110	62	18	22	4	M16
'63	165	125	78	18	24	4	M16
'75	185	145	92	18	26	4	M16
90	200	160	110	18	27	8	M16
110	220	180	133	18	28	8	M16
140	250	210	167	18	30	8	M16
160	285	241	190	22	32	8	M20
200	340	296	226	22	34	8	M20
225	340	295	250	22	34	8	M20
250	395	350	277	22	38	12	M20
280	395	350	310	22	38	12	M20
315	445	400	348	22	42	12	M20

27 70 14
27 70 15

Backing Flanges, PP-V for Butt Fusion Systems Inch/ANSI

Model:

- Modern full-plastic flange PP-GF (30 % glass-fibre reinforced)
- With V-groove which applies force evenly on collar
- With integrated bolt-fixing as an assembly aid
- Connection dimensions according to ANSI B 16.5, ASTM D 4024; bolt circle class 150

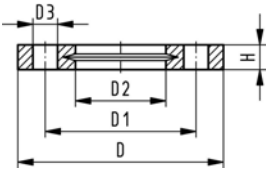

¹⁾ Suitable for socket- and butt fusion systems (no pictograph on flange)

Inch	DN [mm]	PN	Code	NRF	kg	kg/m	
1/2	15	16	727 701 406		0.080	0.080	
3/4	20	16	727 701 407		0.100	0.100	
1	25	16	727 701 408		0.140	0.140	
1 1/4	32	16	727 701 409		0.220	0.220	
1 1/2	40	16	727 701 410		0.210	0.210	
2	50	16	727 701 411		0.380	0.380	
2 1/2	65	16	727 701 412		0.480	0.480	
3	80	16	727 701 513		0.520	0.520	
4	100	16	727 701 514		0.680	0.680	
6	150	16	727 700 517	222 87 76	1.200	1.200	
8	200	16	727 700 519	222 87 78	1.400	1.400	
9	200	16	727 700 520	222 87 79	1.400	1.400	
10	250	16	727 701 521		1.800	1.800	
10	250	16	727 701 522		1.700	1.700	
12	300	16	727 701 523		2.400	2.400	

Inch	DN [mm]	D [mm]	D1 [mm]	D2 [mm]	D3 [mm]	H [mm]	AL	SC	
1/2	15	95	60	28	16	16	4	M12	
3/4	20	105	70	34	16	17	4	M12	
1	25	115	79	42	16	18	4	M12	
1 1/4	32	140	89	51	16	20	4	M16	
1 1/2	40	150	98	62	16	22	4	M16	
2	50	165	121	78	19	24	4	M16	
2 1/2	65	185	140	92	19	26	4	M16	
3	80	200	152	108	19	27	4	M16	
4	100	229	190	128	19	28	8	M16	
6	150	285	241	178	22	32	8	M20	
8	200	340	295	235	22	34	8	M20	
9	200	340	295	238	22	34	8	M20	
10	250	406	362	288	26	38	12	M20	
10	250	406	362	294	26	38	12	M20	
12	300	483	432	338	26	42	12	M20	

27 70 14
27 70 15

Backing Flanges, PP-V for Socket Systems Inch/ANSI

Model:

- Modern full-plastic flange PP-GF (30 % glass-fibre reinforced)
- With V-groove which applies force evenly on collar
- With integrated bolt-fixing as an assembly aid
- Connection dimensions according to ANSI B 16.5, ASTM D 4024; bolt circle class 150

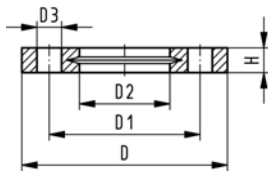

¹⁾ Suitable for socket- and butt fusion systems (no pictograph on flange)

Inch	DN [mm]	PN	Code	NRF	kg	kg/m
1/2	15	16	727 701 406		0.080	0.080
3/4	20	16	727 701 407		0.100	0.100
1	25	16	727 701 408		0.140	0.140
1 1/4	32	16	727 701 409		0.220	0.220
1 1/2	40	16	727 701 410		0.210	0.210
2	50	16	727 701 411		0.380	0.380
2 1/2	65	16	727 701 412		0.480	0.480
3	80	16	727 701 413		0.520	0.520
4	100	16	727 701 414		0.680	0.680
6	150	16	727 700 417	222 87 95	1.200	1.200
9	200	16	727 700 420	222 87 96	1.400	1.400
10	250	16	727 701 422		1.700	1.700
12	300	16	727 701 423		2.400	2.400

Inch	D [mm]	D1 [mm]	D2 [mm]	D3 [mm]	H [mm]	AL	SC
1/2	95	60	28	16	16	4	M12
3/4	105	70	34	16	17	4	M12
1	115	79	42	16	18	4	M12
1 1/4	140	89	51	16	20	4	M16
1 1/2	150	98	62	16	22	4	M16
2	165	121	78	19	24	4	M16
2 1/2	185	140	92	19	26	4	M16
3	200	152	110	19	27	4	M16
4	229	190	133	19	28	8	M16
6	285	241	190	22	32	8	M20
9	340	295	250	22	34	8	M20
10	406	362	310	26	38	12	M20
12	483	432	348	26	42	12	M20

Backing Flanges, Galvanised Steel

24 70 14

Galvanised Flange for Socket BS10:1962 Table D&E

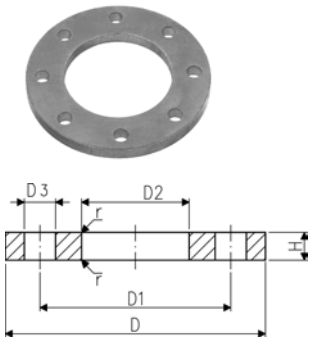

d [mm]	DN [mm]	PN	Code	SP	kg	kg/m
20	15	16	724 701 406	-	0.220	0.220
25	20	16	724 701 407	-	0.320	0.320
32	25	16	724 701 408	-	0.410	0.410
40	32	16	724 701 409	-	0.820	0.820
50	40	16	724 701 410	-	1.220	1.220
63	50	16	724 701 411	-	1.400	1.400
75	65	16	724 701 412	-	1.530	1.530
90	80	16	724 701 413	-	1.840	1.840
110	100	16	724 703 414	-	1.840	1.840
		16	724 701 415	-	1.840	1.840
140	125	16	724 701 416	-	2.070	2.070
		16	724 701 417	-	2.330	2.330
225	200	10	724 701 419	-	2.750	2.750

d [mm]	D [mm]	D1 [mm]	D2 [mm]	D3 [mm]	H [mm]	AL	SC
20	96	67	28	15	7	4	M12x55
25	102	75	34	15	7	4	M12x60
32	115	83	42	15	7	4	M12x60
40	121	88	51	15	8	4	M12x70
50	134	99	62	15	8	4	M12x75
63	153	115	78	18	10	4	M16x80
75	165	127	92	18	10	4	M16x85
90	184	146	110	18	10	4	M16x90
110	216	178	133	18	10	8	M16x95
	216	178	138	18	10	8	M16x95
140	254	210	167	18	10	8	M16x110
	280	235	200	22	10	8	M20x120
225	337	292	250	22	10	8	M20x150

24 70 16

Galvanised Flange for Socket ISO/BS4504: 1969 PN10/16

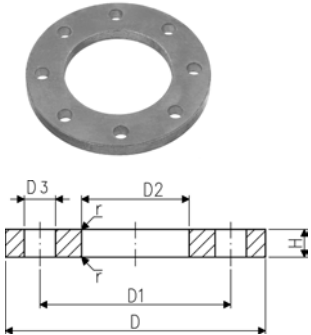

d [mm]	DN [mm]	PN	Code	D [mm]	D1 [mm]	D2 [mm]	D3 [mm]	H [mm]	AL	SC
20	15	16	724 701 606	95	65	28	14	7	4	M12x55
25	20	16	724 701 607	105	75	34	14	7	4	M12x60
32	25	16	724 701 608	115	85	42	14	7	4	M12x60
40	32	16	724 701 609	140	100	51	18	8	4	M16x70
50	40	16	724 701 610	150	110	62	18	8	4	M16x75
63	50	16	724 701 611	165	125	78	18	10	4	M16x80
75	65	16	724 701 612	185	145	92	18	10	4	M16x85
90	80	16	724 701 613	200	160	110	18	10	4	M16x90
110	100	16	724 700 014	220	180	133	18	10	8	M16x95
		16	724 701 615	220	180	133	18	10	4	M16x95
140	125	16	724 701 616	250	210	167	18	10	8	M16x110
		16	724 701 617	285	240	200	22	10	8	M20x120
225	200	10	724 701 620	340	295	250	22	10	8	M20x150
225	200	16	724 701 720	340	295	250	22	10	12	M20x150

Galvanised Flange for Socket BS1560:1958 ANSI B16.5 Class 150

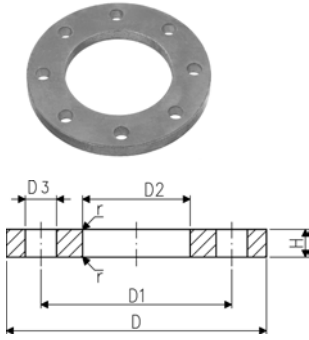

d [mm]	DN [mm]	PN	Code	SP	kg	kg/m
20	15	16	724 701 806	-	0.230	0.230
25	20	16	724 701 807	-	0.300	0.300
32	25	16	724 701 808	-	0.350	0.350
40	32	16	724 701 809	-	0.480	0.480
50	40	16	724 701 810	-	0.650	0.650
63	50	16	724 701 811	-	0.990	0.990
75	65	16	724 701 812	-	1.200	1.200
90	80	16	724 701 813	-	1.310	1.310
110	100	16	724 703 814	-	2.011	2.011
		16	724 701 815	-		
140	125	16	724 701 816	-	2.000	2.000
		16	724 701 817	-	1.950	1.950
225	200	16	724 701 820	-	3.160	3.160

d [mm]	D [mm]	D1 [mm]	D2 [mm]	D3 [mm]	H [mm]	AL	SC
20	89	60	28	16	7	4	M12x55
25	98	70	34	16	7	4	M12x60
32	108	79	42	16	7	4	M12x60
40	117	89	51	16	8	4	M12x70
50	127	98	62	16	10	4	M12x75
63	152	121	78	19	10	4	M16x80
75	178	140	92	19	10	4	M16x85
90	190	152	110	19	10	4	M16x90
110	229	190	133	19	10	8	M16x95
	229	190	138	19	10	8	M16x95
140	254	216	167	22	10	8	M20x120
	279	241	200	22	10	8	M20x120
225	343	298	250	22	10	8	M20x150

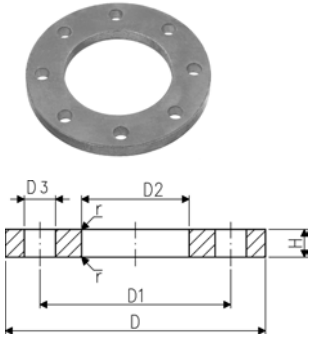

d [mm]	DN [mm]	PN	Code	SP	kg	kg/m
20	15	16	724 701 406	-	0.220	0.220
25	20	16	724 701 407	-	0.320	0.320
32	25	16	724 701 408	-	0.410	0.410
40	32	16	724 701 409	-	0.820	0.820
50	40	16	724 701 410	-	1.220	1.220
63	50	16	724 701 411	-	1.400	1.400
75	65	16	724 701 412	-	1.530	1.530
90	80	16	724 701 413	-	1.840	1.840
110	100	16	724 703 914			
140	125	16	724 703 916			
160	150	16	724 703 917			
200	200	16	724 703 919			
225	200	16	724 703 920			
250		10	724 703 921			
280	250	6	724 703 922			
315	300	6	724 703 923			

d [mm]	D [mm]	D1 [mm]	D2 [mm]	D3 [mm]	H [mm]	AL	SC
20	96	67	28	15	7	4	M12x55
25	102	75	34	15	7	4	M12x60
32	115	83	42	15	7	4	M12x60
40	121	88	51	15	8	4	M12x70
50	134	99	62	15	8	4	M12x75
63	153	115	78	18	10	4	M16x80
75	165	127	92	18	10	4	M16x85
90	184	146	110	18	10	4	M16x90
110	216	178	128	18	10	8	M16x95
140	254	210	158	18	10	8	M16x110
160	280	235	178	22	10	8	M20x120
200	305	260	235	22	10	8	M20x150
225	337	292	238	22	10	8	M20x150
250	368	324	288	22	12	8	M20x150
280	406	356	294	22	12	8	M20x240
315	457	406	338	22	12	12	M20x260

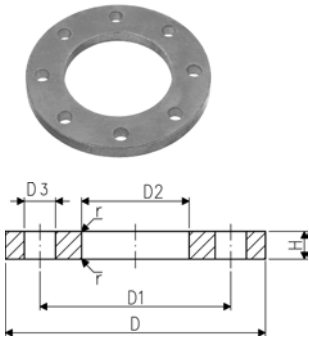
Galvanised Flange for Butt Fusion ISO/BS4504: 1969
PN10/16

d [mm]	DN [mm]	PN	Code	D [mm]	D1 [mm]	D2 [mm]	D3 [mm]	H [mm]	AL	SC
20	15	16	724 701 606	95	65	28	14	7	4	M12x55
25	20	16	724 701 607	105	75	34	14	7	4	M12x60
32	25	16	724 701 608	115	85	42	14	7	4	M12x60
40	32	16	724 701 609	140	100	51	18	8	4	M16x70
50	40	16	724 701 610	150	110	62	18	8	4	M16x75
63	50	16	724 701 611	165	125	78	18	10	4	M16x80
75	65	16	724 701 612	185	145	92	18	10	4	M16x85
90	80	16	724 701 613	200	160	110	18	10	4	M16x90
110	100	16	724 700 914	220	180	128	18	10	8	M16x95
125	100	16	724 700 915	220	180	135	18	10	8	M16x95
140	125	16	724 700 916	250	210	158	18	10	8	M16x110
160	150	16	724 700 917	285	240	178	22		8	M20x120
180		10	724 700 918							
200	200	10	724 700 919	340	295	235	22	10	8	M20x150
225	200	10	724 700 920	340	295	238	22	10	8	M20x150
250		10	724 700 921		350	288				
280	250	10	724 700 922	395	350	294	22	12	12	M20x240
315	300	10	724 700 923	445	400	338	22	12	12	M20x260
355		10	724 700 924	505	460	376	22	16	16	M20
400		10	724 700 925	565	515	431	26	16	16	M2k

Galvanised Flange for Butt Fusion BS1560:1958 ANSI B16.5 Class 150

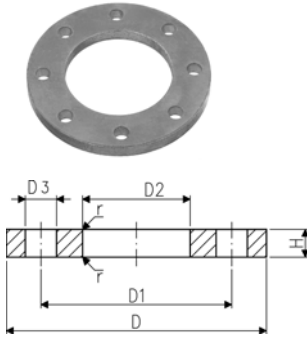

d [mm]	DN [mm]	PN	Code	SP	kg	kg/m
20	15	16	724 701 806	-	0.230	0.230
25	20	16	724 701 807	-	0.300	0.300
32	25	16	724 701 808	-	0.350	0.350
40	32	16	724 701 609	-		
50	40	16	724 701 810	-	0.650	0.650
63	50	16	724 701 811	-	0.990	0.990
75	65	16	724 701 812	-	1.200	1.200
90	80	16	724 701 813	-	1.310	1.310
110	100	16	724 701 914			
125	100	16	724 701 915			
140	125	16	724 701 916			
160	150	16	724 701 917			
200	200		724 701 919			
225	200	16	724 701 920			
280	250	10	724 701 922			
315	300	6	724 701 923			

d [mm]	D [mm]	D1 [mm]	D2 [mm]	D3 [mm]	H [mm]	AL	SC
20	89	60	28	16	7	4	M12x55
25	98	70	34	16	7	4	M12x60
32	108	79	42	16	7	4	M12x60
40	140	100	51	18	8	4	M16x70
50	127	98	62	16	10	4	M12x75
63	152	121	78	19	10	4	M16x80
75	178	140	92	19	10	4	M16x85
90	190	152	110	19	10	4	M16x90
110	229	190	135	20	10	8	M16x110
125	229	190	135	20	10	8	M16x110
140	254	216	158	22	10	8	M16x110
160	279	241	178	22	10	8	M20x120
200	348	298	235	22	10		M20x150
225	343	298	238	22	10	8	M20x150
280	406	362	294	22	12	12	M20x240
315	483	432	338	22	12	12	M20x260

Backing Flanges, PP/Steel

27 70 02
27 70 03

Backing Flanges, PP/Steel for Butt Fusion Systems metric

Model:

- Material: PP (30 % glass-fibre reinforced) with steel ring
- Connecting dimensions: ISO 7005 / EN 1092 / DIN 2501 PN10 / BS4504

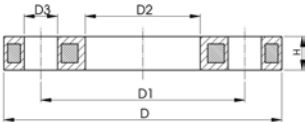

d [mm]	DN [mm]	PN	Code	D [mm]	D1 [mm]	D2 [mm]	D3 [mm]	H [mm]	AL	SC
20	15	16	727 700 206	95	65	28	14	12	4	M12
25	20	16	727 700 207	105	75	34	14	12	4	M12
32	25	16	727 700 208	115	85	42	14	16	4	M12
40	32	16	727 700 209	140	100	51	18	16	4	M16
50	40	16	727 700 210	150	110	62	18	18	4	M16
63	50	16	727 700 211	165	125	78	18	18	4	M16
75	65	16	727 700 212	185	145	92	18	18	4	M16
90	80	16	727 700 313	200	160	108	18	20	8	M16
110	100	16	727 700 314	220	180	128	18	20	8	M16
125	100	16	727 700 315	220	180	135	18	20	8	M16
140	125	16	727 700 316	250	210	158	18	24	8	M16
160	150	16	727 700 317	285	240	178	22	24	8	M20
180	150	16	727 700 318	285	240	188	22	24	8	M20
200	200	16	727 700 319	340	295	235	22	27	8	M20
225	200	16	727 700 320	340	295	238	22	27	8	M20
250	250	16	727 700 321	395	350	288	22	30	12	M20
280	250	16	727 700 322	395	350	294	22	30	12	M20
315	300	16	727 700 323	445	400	338	22	34	12	M20
355	350	16	727 700 324	515	460	376	23	40	16	M20
400	400	16	727 700 325	574	515	430	26	40	16	M24

27 70 02

Backing Flanges, PP/Steel for Socket Systems metric

Model:

- PP-GF (30% glass-fibre reinforced) with steel ring
- Connecting dimensions: ISO 7005, EN 1092, BS 4504, DIN 2501; bolt circle PN 10

*** Connecting dimension: ISO 2536**

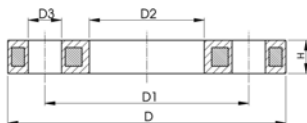

d [mm]	DN [mm]	PN	Code	D [mm]	D1 [mm]	D2 [mm]	D3 [mm]	H [mm]	AL	SC
20	15	16	727 700 206	95	65	28	14	12	4	M12
25	20	16	727 700 207	105	75	34	14	12	4	M12
32	25	16	727 700 208	115	85	42	14	16	4	M12
40	32	16	727 700 209	140	100	51	18	16	4	M16
50	40	16	727 700 210	150	110	62	18	18	4	M16
63	50	16	727 700 211	165	125	78	18	18	4	M16
75	65	16	727 700 212	185	145	92	18	18	4	M16
90	80	16	727 700 213	200	160	110	18	20	8	M16
110	100	16	727 700 214	220	180	133	18	20	8	M16
125	100	16	727 700 215	250	210	150	18	24	8	M16
140	125	16	727 700 216	250	210	167	18	24	8	M16
160	150	16	727 700 217	285	240	190	22	24	8	M20
200	200	16	727 700 219	340	295	226	22	27	8	M20
225	200	16	727 700 220	340	295	250	22	27	8	M20
250	250	16	727 700 021	395	350	277	22	30	12	M20
*250	250	16	727 700 221	395	325	277	22	30	8	M20
280	250	16	727 700 222	395	350	310	22	30	12	M20
315	300	16	727 700 223	445	400	348	22	34	12	M20
355	350	16	727 700 224	515	460	388	23	40	16	M20
400	400	16	727 700 225	574	515	442	26	40	16	M24

24 70 04

Profiled Backing Flanges, PP/Steel for Butt Fusion Systems metric

Model:

- PP with glass-fibre reinforcement and GGG 50 insert
- Connecting dimensions: ISO 7005, EN 1092, DIN 2501
- **Bolt circle PN 10**

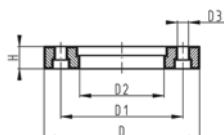

d [mm]	DN [mm]	PN	Code	kg	kg/m	D [mm]	D1 [mm]	D2 [mm]	D3 [mm]	H [mm]	AL	SC
355	350	10	724 700 424	15.570	15.570	521	460	376	22	48	16	M20
400	400	10	724 700 425	19.800	19.800	582	515	430	26	51	16	M24
450	500	10	724 700 426	25.600	25.600	684	620	517	26	49	20	M24
500	500	10	724 700 427	24.300	24.300	684	620	533	26	49	20	M24
560	600	10	724 700 428	35.700	35.700	796	725	618	30	58	20	M27
630	600	10	724 700 429	32.500	32.500	796	725	645	30	68	20	M27

27 70 12

Backing Flanges, PP/Steel for Socket Systems Inch/ANSI

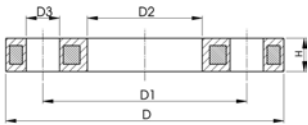

Model:

- For socket systems
- For Flange Adaptors BS (ANSI)
- Material: PP (30 % glass-fibre reinforced) with steel ring
- Connecting dimension ANSI B 16.5 / ASTM D 4024
- DN100 and DN150: only for use with original metric flange adaptors

Inch	DN [mm]	d [mm]	PN	Code	kg	kg/m	D [mm]	D1 [mm]	D2 [mm]	D3 [mm]	H [mm]	AL	
1/2	15	20	16	727 701 206	0.210	0.210	95	60	28	16	12	4	
3/4	20	25	16	727 701 207	0.250	0.250	105	70	34	16	12	4	
1	25	32	16	727 701 208	0.420	0.420	115	79	42	16	16	4	
1 1/4	32	40	16	727 701 209	0.670	0.670	140	89	51	16	16	4	
1 1/2	40	50	16	727 701 210	0.860	0.860	150	98	62	16	18	4	
2	50	63	16	727 701 211	0.930	0.930	165	121	78	19	18	4	
2 1/2	65	75	16	727 701 212	1.340	1.340	185	140	92	19	18	4	
3	80	90	16	727 701 213	1.550	1.550	200	152	110	19	20	4	
4	100	110	16	727 701 214	1.810	1.810	229	190	133	19	20	8	
6	150	180	16	727 701 217	3.390	3.390	285	241	190	22	24	8	
8	200	200	16	727 701 220	4.410	4.410	340	298	250	22	27	8	

24 70 03

Profiled Backing Flanges, PP/Steel for Butt Fusion Systems metric

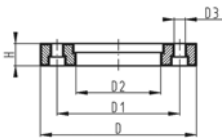

Model:

- PP with glass-fibre reinforcement and GGG 50 insert
- Connecting dimensions: ISO 7005, EN 1092, DIN 2501
- **Bolt circle PN 16**

d [mm]	DN [mm]	PN	Code	kg	kg/m	D [mm]	D1 [mm]	D2 [mm]	D3 [mm]	H [mm]	AL	SC	
200	200	16	724 700 319	3.720	3.720	344	295	235	22	28	12	M20	
225	200	16	724 700 320	3.320	3.320	344	295	238	22	28	12	M20	
250	250	16	724 700 321	6.390	6.390	405	355	288	26	31	12	M24	
280	250	16	724 700 322	6.310	6.310	405	355	294	26	31	12	M24	
315	300	16	724 700 323	9.740	9.740	465	410	338	26	38	12	M24	
355	350	16	724 700 324	16.300	16.300	532	470	376	26	48	16	M24	
400	400	16	724 700 325	20.600	20.600	594	525	430	30	54	16	M27	

Fixed Flange PP

27 30 10
27 40 10

Fixed Flanges, PP-H metric Jointing Face flat

Model:

- With fusion socket metric
- Connecting dimension: ISO 7005 PN 10, EN 1092 PN 10, DIN 2501 PN 10, BS 4504 PN 10

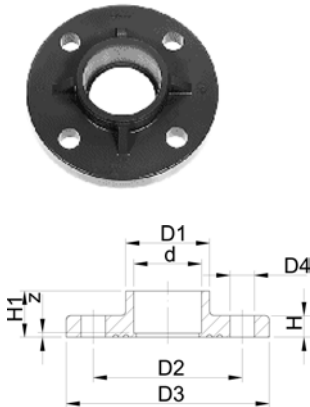

d [mm]	DN [mm]	Inch	PN	Code	kg	kg/m
20	15	1/2	10	727 730 106	0.069	0.069
25	20	3/4	10	727 730 107	0.094	0.094
32	25	1	10	727 730 108	0.129	0.129
40	32	1 1/4	10	727 730 109	0.203	0.203
50	40	1 1/2	10	727 730 110	0.246	0.246
63	50	2	10	727 730 111	0.330	0.330

d [mm]	D1 [mm]	D2 [mm]	D3 [mm]	D4 [mm]	H [mm]	H1 [mm]	AL	z [mm]
20	27	65	94	14	12	19	4	5
25	33	75	103	14	13	21	4	5
32	40	85	115	14	14	23	4	5
40	50	100	138	18	15	25	4	5
50	61	110	148	18	16	27	4	5
63	76	125	163	18	18	31	4	5

27 30 10
27 40 10

Fixed Flanges, PP-H metric Jointing Face serrated

Model:

- With fusion socket metric
- Connecting dimension: ISO 7005 PN 10, EN 1092 PN 10, DIN 2501 PN 10, BS 4504 PN 10

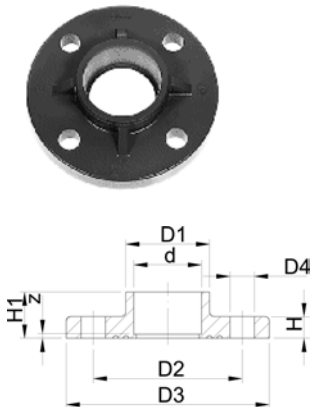

d [mm]	DN [mm]	Inch	PN	Code	SP	kg	kg/m
20	15	1/2	10	727 740 106	-	0.069	0.069
25	20	3/4	10	727 740 107	-	0.094	0.094
32	25	1	10	727 740 108	-	0.129	0.129
40	32	1 1/4	10	727 740 109	-	0.203	0.203
50	40	1 1/2	10	727 740 110	-	0.246	0.246
63	50	2	10	727 740 111	-	0.330	0.330

d [mm]	D1 [mm]	D2 [mm]	D3 [mm]	D4 [mm]	H [mm]	H1 [mm]	AL	z [mm]
20	27	65	94	14	12	19	4	5
25	33	75	103	14	13	21	4	5
32	40	85	115	14	14	23	4	5
40	50	100	138	18	15	25	4	5
50	61	110	148	18	16	27	4	5
63	76	125	163	18	18	31	4	5

Seals

EPDM 48 41 00
FPM 49 41 00

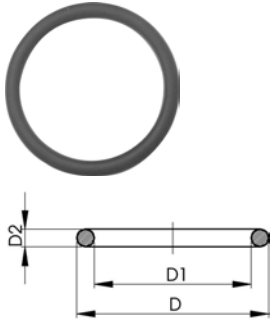

O-Ring Gaskets

Model:

- For unions
- Hardness approx. 65° Shore
- EPDM minimum temperature -40°C
- FPM minimum temperature -15°C

d [mm]	DN [mm]	EPDM Code	FPM Code	SP	kg	D [mm]	D1 [mm]	D2 [mm]
10-12	8	748 410 004	749 410 004	-	0.002	18	12	3
16	10	748 410 005	749 410 005	-	0.002	21	16	3
20	15	748 410 006	749 410 006	-	0.002	27	20	4
25	20	748 410 007	749 410 007	100	0.002	35	28	4
32	25	748 410 008	749 410 008	100	0.002	40	33	4
40	32	748 410 009	749 410 009	-	0.006	51	41	5
50	40	748 410 010	749 410 010	-	0.007	58	47	5
63	50	748 410 011	749 410 011	100	0.010	70	60	5
75	65	748 410 014	749 410 014	100	0.012	93	82	5
90	80	748 410 015	749 410 015	100	0.015	112	101	5
110	100	748 410 016	749 410 016	50	0.031	134	120	7

EPDM 48 41 01
FPM 49 41 01

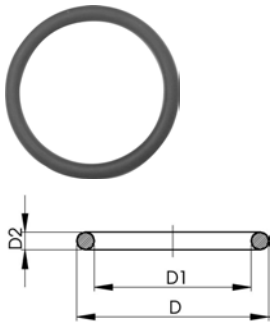

O-Ring Gaskets

Model:

- For Flange Adaptors
- Hardness approx. 65° Shore

d [mm]	DN [mm]	EPDM Code	FPM Code	SP	kg	D [mm]	D1 [mm]	D2 [mm]
16	10	748 410 000	749 410 000	-	0.002	26	19	4
20	15	748 410 001	749 410 001	100	0.002	31	23	4
25	20	748 410 007	749 410 007	100	0.002	35	28	4
32	25	748 410 002	749 410 002	100	0.003	43	36	4
40	32	748 410 003	749 410 003	-	0.007	55	44	5
50	40	748 410 012	749 410 012	100	0.008	64	53	5
63	50	748 410 013	749 410 013	100	0.011	80	69	5
75	65	748 410 014	749 410 014	100	0.012	93	82	5
90	80	748 410 015	749 410 015	100	0.015	112	101	5
110	100	748 410 016	749 410 016	50	0.031	134	120	7
125	100	748 410 017	749 410 017	200	0.036	150	136	7
140	125	748 410 018	749 410 018	200	0.039	166	152	7
160	150	748 410 019	749 410 019	200	0.047	191	177	7
200	200	748 410 163	749 410 163	-	0.056	236	222	7
225	200	748 410 022	749 410 022	150	0.060	255	241	7
250	250	748 410 182	749 410 182	-	0.003	280	266	7
280	250	748 410 173	749 410 173	-	0.044	306	292	7
315	300	748 410 174	749 410 174	-	0.051	356	342	7

EPDM 48 44 03
FPM 49 44 03

Flange Gaskets for Flange Connections metric

Model:

- Hardness: 70° Shore **EPDM**, 75° Shore **FPM**
- Suitable for flange adaptors

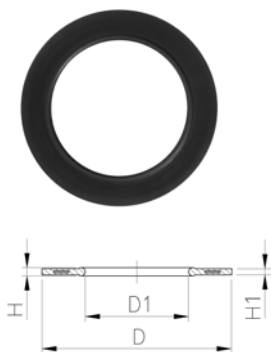

d [mm]	EPDM Code	FPM Code	SP	kg	D [mm]	D1 [mm]	H [mm]	H1 [mm]
20	748 440 101	749 440 101	-	0.008	51	20	4	3
25	748 440 302	749 440 302	-	0.010	61	22	4	3
32	748 440 303	749 440 303	-	0.016	71	28	4	3
40	748 440 304	749 440 304	-	0.025	82	34	4	3
50	748 440 305	749 440 305	-	0.033	92	42	4	3
63	748 440 306	749 440 306	-	0.048	107	53	5	4
75	748 440 307	749 440 307	-	0.076	127	63	5	4
90	748 440 308	749 440 308	-	0.076	142	76	5	4
110	748 440 309	749 440 309	-	0.112	162	93	6	5
125	748 440 310	749 440 310	-	0.110	162	105	6	5
140	748 440 311	749 440 311	-	0.146	192	117	6	5
160	748 440 312	749 440 312	-	0.207	218	135	8	6
180	748 440 313	749 440 313	-	0.260	218	151	8	6
200	748 440 314	749 440 314	-	0.430	273	168	8	6
225	748 440 315	749 440 315	-	0.365	273	188	8	6
250	748 440 316	749 440 316	-	0.520	328	208	8	6
280	748 440 317	749 440 317	-	0.496	328	233	8	6
315	748 440 318	749 440 318	-	0.600	378	262	8	6
355	748 440 319	749 440 319	-	0.750	438	294	8	6
400	748 440 320	749 440 320	-	0.750	489	331	8	6

EPDM 48 44 01
FPM 49 44 01

Flange Gaskets

Model:

- G-ST-P/K Profil
- Hardness: 70° Shore **EPDM**, 75° Shore **FPM**
- For Flange Adaptors
- For flange adaptors only in combination with butterfly valves

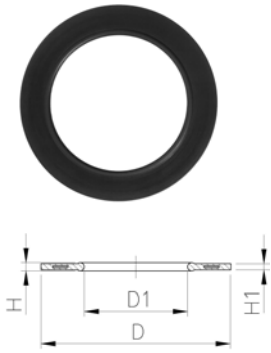

d [mm]	EPDM Code	FPM Code	kg	D [mm]	D1 [mm]	H [mm]	H1 [mm]
16	748 440 100	749 440 100	0.007	46	16	4	3
20	748 440 101	749 440 101	0.008	51	20	4	3
25	748 440 102	749 440 102	0.011	61	25	4	3
32	748 440 103	749 440 103	0.014	71	32	4	3
40	748 440 104	749 440 104	0.020	82	40	4	3
50	748 440 105	749 440 105	0.021	92	50	4	3
63	748 440 106	749 440 106	0.040	107	63	5	4
75	748 440 107	749 440 107	0.054	127	75	5	4
90	748 440 108	749 440 108	0.060	142	90	5	4
110	748 440 109	749 440 109	0.083	162	110	6	5
125	748 440 110	749 440 110	0.154	192	125	6	5
140	748 440 111	749 440 111	0.115	192	140	6	5
160	748 440 112	749 440 112	0.149	218	160	8	6
200	748 440 114	749 440 114	0.257	273	200	8	6
225	748 440 115	749 440 115	0.177	273	225	8	6
280	748 440 117	749 440 117	0.220	328	280	8	6
315	748 440 118	749 440 118	0.326	378	315	8	6
355	748 440 119	749 440 119	0.400	438	355	10	7
400	748 440 120	749 440 120	0.500	489	400	10	7

EPDM 48 40 00
FPM 49 40 00

Flat Gaskets

Model:

- Hardness approx. 65° Shore
- For adaptor unions

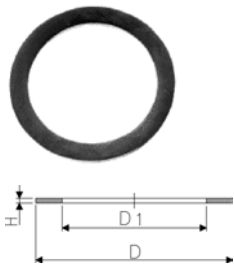

d [mm]	Inch	EPDM Code	FPM Code	kg	D [mm]	D1 [mm]	H [mm]
12	1/4	748 400 004	-	0.002	20	13	2
16	3/8	748 400 005	749 400 005	0.002	24	17	2
20	1/2	748 400 006	749 400 006	0.003	30	21	3
25	3/4	748 400 007	749 400 007	0.004	38	27	3
32	1	748 400 008	749 400 008	0.002	44	32	3
40	1 1/4	748 400 009	749 400 009	0.003	55	42	3
50	1 1/2	748 400 010	749 400 010	0.004	62	46	3
63	2	748 400 011	749 400 011	0.006	78	60	3
75	2 1/2	748 400 012	749 400 012	0.009	97	75	3
90	3	748 400 013	749 400 013	0.011	109	88	3

EPDM 48 40 00
FPM 49 40 00

Flat Gaskets

Model:

- For Flange Adaptors 21 79 01/21 80 01
- Hardness: 70° Shore **EPDM**, 75° Shore **FPM**

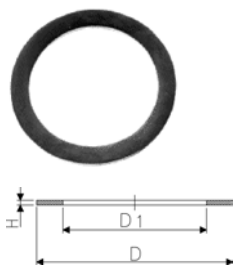

d [mm]	DN [mm]	Inch	PN	EPDM Code	NRF	FPM Code	SP	kg
16	10	3/8	10	748 400 014		-	-	0.002
20	15	1/2	10	748 400 015	222 85 42	749 400 015	100	0.003
25	20	3/4	10	748 400 016	222 85 43	749 400 016	100	0.003
32	25	1	10	748 400 017	222 85 44	749 400 017	100	0.004
40	32	1 1/4	10	748 400 018	222 85 45	749 400 018	100	0.008
50	40	1 1/2	10	748 400 019	222 85 46	749 400 019	100	0.012
63	50	2	10	748 400 020	222 85 47	749 400 020	-	0.017
75	65	2 1/2	10	748 400 021	222 85 48	749 400 021	50	0.024
90	80	3	10	748 400 022	222 85 49	749 400 022	50	0.032
110	100	4	10	748 400 023	222 85 51	749 400 023	-	0.062
125	100	4	10	748 400 024	222 85 52	749 400 024	-	0.058
140	125	5	10	748 400 025	222 85 54	749 400 025	-	0.058
160	150	6	10	748 400 026	222 85 56	749 400 026	-	0.063
200	200	6	6	748 400 031	222 85 58	-	50	0.090
225	200	8	6	748 400 027	222 85 61	749 400 027	-	0.103
280	250	10	6	748 400 032		-	-	0.138
315	300	12	6	748 400 033		-	-	0.207

d [mm]	D [mm]	D1 [mm]	H [mm]
16	27	16	2
20	32	20	2
25	39	25	2
32	48	32	2
40	59	40	3
50	71	50	3
63	88	63	3
75	104	75	3
90	123	90	3
110	148	110	4
125	168	125	4
140	186	140	4
160	211	160	4
200	248	195	5
225	272	220	5
280	328	273	5
315	378	305	5

Pipe Clips metric

KLIP-IT Pipe Clips Type 061H, PP metric

Model:

- For mm-pipes d16-d63
- Material: PP black, UV resistant
- **Minimum order quantity: standard packagings SP**

- Height designed for Ball Valve Type 546
- * d16 to d32 without bracket

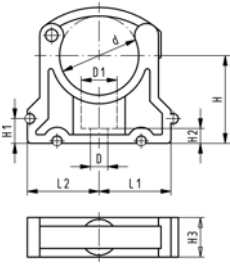

d [mm]	Code	NRF	SP	kg	kg/m
*16	167 061 035	222 85 74	10	0.006	0.006
*20	167 061 036	222 85 75	10	0.008	0.008
*25	167 061 037	222 85 76	10	0.009	0.009
*32	167 061 038	222 85 77	10	0.012	0.012
40	167 061 039	222 85 78	10	0.027	0.027
50	167 061 040	222 85 79	10	0.031	0.031
63	167 061 041	222 85 81	10	0.054	0.054

d [mm]	D [mm]	D1 [mm]	L1 [mm]	L2 [mm]	H [mm]	H1 [mm]	H2 [mm]	H3 [mm]	SC
*16	6	11	14	17	27	10	6	16	M5
*20	6	11	17	19	27	10	6	16	M5
*25	6	11	19	22	30	10	6	16	M5
*32	6	11	24	27	36	10	6	16	M5
40	7	14	34	34	44	10	7	22	M6
50	7	14	37	37	51	10	7	22	M6
63	9	17	45	45	64	10	10	25	M8

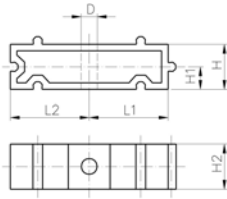

KLIP-IT Spacer Type 061, PP

Model:

- For pipe clips Type 061/061H, PP black, UV resistant
- **Minimum order quantity: standard packaging SP**

d [mm]	Inch	Code	SP	kg	kg/m	D [mm]	L1 [mm]	L2 [mm]	H [mm]	H1 [mm]	H2 [mm]	SC
10-12	1/8-1/4	167 061 153	10	0.003	0.003	5	11	14	20	10	12	M4
16	3/8	167 061 155	10	0.006	0.006	6	14	17	20	10	16	M5
20	1/2	167 061 156	10	0.006	0.006	6	17	19	20	10	16	M5
25	3/4	167 061 157	10	0.007	0.007	6	19	22	20	10	16	M5
32	1	167 061 158	10	0.008	0.008	6	24	27	20	10	16	M5
40	1 1/4	167 061 159	10	0.016	0.016	7	34	34	20	10	22	M6
50	1 1/2	167 061 160	10	0.017	0.017	7	37	37	20	10	22	M6
63	2	167 061 161	10	0.024	0.024	9	45	45	20	10	25	M8
75	2 1/2	167 061 162	10	0.027	0.027	9	52	52	20	10	25	M8
90	3	167 061 163	10	0.040	0.040	9	65	65	20	10	28	M8
110	4	167 061 164	10	0.048	0.048	9	79	79	20	10	28	M8
125	4 1/2	167 061 165	10	0.059	0.059	9	88	88	20	10	32	M8
140	5	167 061 166	10	0.065	0.065	9	98	98	20	10	32	M8
160	6	167 061 167	10	0.074	0.074	9	109	109	20	10	32	M8

KLIP-IT Pipe Clips Type 061, PE metric



Model:

- For mm pipes
- Material: Clip PE and safety clip PP black
- **Minimum order quantity: standard packaging SP**

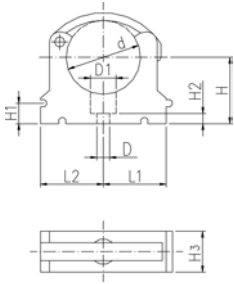

d [mm]	Code	SP	kg	kg/m	D [mm]	D1 [mm]	L1 [mm]	L2 [mm]	H [mm]	H1 [mm]	H2 [mm]	H3 [mm]	SC
*10	173 061 003	10	0.003	0.003	5	8	11	14	20	10	6	12	M4
*12	173 061 004	10	0.006	0.006	5	8	11	14	21	10	6	12	M5
*16	173 061 005	10	0.007	0.007	6	11	14	17	23	10	6	16	M5
*20	173 061 006	10	0.008	0.008	6	11	17	19	25	10	6	16	M5
*25	173 061 007	10	0.009	0.009	6	11	19	22	28	10	6	16	M5
*32	173 061 008	10	0.012	0.012	6	11	24	27	31	10	6	16	M5
40	173 061 009	10	0.022	0.022	7	14	34	34	35	10	7	22	M6
50	173 061 010	10	0.030	0.030	7	14	37	37	40	10	7	22	M6
63	173 061 011	10	0.044	0.044	9	17	45	45	52	10	10	25	M8
75	173 061 012	10	0.062	0.062	9	17	52	52	58	10	10	25	M8
90	173 061 013	10	0.090	0.090	9	17	65	65	65	10	10	28	M8
110	173 061 014	10	0.114	0.114	9	17	79	79	75	10	10	28	M8
125	173 061 015	10	0.174	0.174	9	17	88	88	90	10	10	32	M8
140	173 061 016	10	0.217	0.217	9	17	98	98	110	10	10	32	M8
160	173 061 017	10	0.237	0.237	9	17	109	109	108	10	10	32	M8

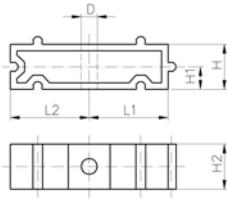

KLIP-IT Spacer Type 061, PE

Model:

- For pipe clips Type 061, PE black, UV resistant
- **Minimum order quantity: standard packaging SP**

d	Inch	Code	SP	kg	kg/m	D	L1	L2	H	H1	H2	SC
[mm]						[mm]	[mm]	[mm]	[mm]	[mm]	[mm]	
	1/8-1/4	173 061 153	10	0.003	0.003	5	11	14	20	10	12	M4
16	3/8	173 061 155	10	0.005	0.005	6	14	17	20	10	16	M5
20	1/2	173 061 156	10	0.006	0.006	6	17	19	20	10	16	M5
25	3/4	173 061 157	10	0.007	0.007	6	19	22	20	10	16	M5
32	1	173 061 158	10	0.008	0.008	6	24	27	20	10	16	M5
40	1 1/4	173 061 159	10	0.016	0.016	7	34	34	20	10	22	M6
50	1 1/2	173 061 160	10	0.017	0.017	7	37	37	20	10	22	M6
63	2	173 061 161	10	0.025	0.025	9	45	45	20	10	25	M8
75	2 1/2	173 061 162	10	0.027	0.027	9	52	52	20	10	25	M8
90	3	173 061 163	10	0.040	0.040	9	65	65	20	10	28	M8
110	4	173 061 164	10	0.048	0.048	9	79	79	20	10	28	M8
125	4 1/2	173 061 165	10	0.059	0.059	9	88	88	20	10	32	M8
140	5	173 061 166	10	0.065	0.065	9	98	98	20	10	32	M8
160	6	173 061 167	10	0.074	0.074	9	109	109	20	10	32	M8



Pipe Clips Type 060, PP metric

Model:

- For mm pipes d90-400
- Material: Clip and safety clip PP black, UV resistant
- Accidental opening of the safety clip is not possible
- **Minimum order quantity: standard packaging SP or gross packaging GP**
- Clip and safety clip are not assembled in the packaging.
- Pipes with flanges can be installed directly

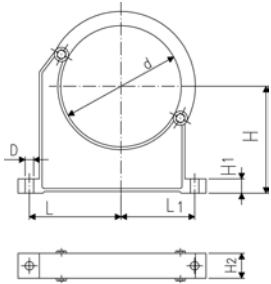

d [mm]	d [inch]	Code	NRF	SP	kg	kg/m
90	3	167 060 038	222 86 03	10	0.163	0.163
110		167 060 039	222 86 04	10	0.179	0.179
125		167 060 040	222 86 05	10	0.300	0.300
140	5	167 060 041	222 86 06	10	0.309	0.309
160		167 060 042	222 86 08	10	0.348	0.348
180		167 060 043		5	0.378	0.378
200		167 060 019	222 86 11	5	0.582	0.582
225		167 060 020	222 86 13	5	0.612	0.612
250		167 060 021		5	0.698	0.698
280		167 060 022		5	0.722	0.722
315		167 060 023		5	0.842	0.842
355		167 060 024		5	1.250	1.250
400		167 060 025		5	1.450	1.450

d [mm]	D [mm]	L [mm]	L1 [mm]	H [mm]	H1 [mm]	H2 [mm]	SC
90	9	89	71	105	15	33	M 8
110	9	94	80	115	15	33	M 8
125	11	116	91	130	20	35	M10
140	11	121	98	130	20	35	M10
160	11	131	107	148	20	35	M10
180	11	143	115	163	20	35	M10
200	13	152	120	175	25	39	M12
225	13	165	132	175	25	39	M12
250	13	183	143	200	25	39	M12
280	13	198	156	200	25	39	M12
315	13	219	172	225	25	39	M12
355	17	275	209	258	30	50	M16
400	17	300	228	288	30	50	M16

Cleaner

KS Tangit Cleaner

- Special cleaning agent for plastic fusion connections with PP, PE, PVDF and PB.



Code	SP	kg	
799 298 023	-	0.890	

IR-63 Plus® Fusion Jointing Machine and Accessories



IR-63 Plus® Fully-Equipped Machine

Fully-equipped fusion jointing machine for welding SYGEF® Standard, SYGEF® Plus, DEKAPROP®, PROGEF® Natural, PROGEF® Plus, PE 100 in dimensions d 20-63 mm with integrated remote welding unit.

Supply:

1-phase AC (50/60 Hz) 230 V L/N/PE

Delivery includes:

- Machine housing complete (1 pcs.)
- Heater assembly (1 pcs.)
- Remote weld device (1 pcs.)
- Facing tool (1 pcs.)
- Transport box (1 pcs.)
- Pipe stop (1 pcs.)
- Clamping inserts d 20-63 mm (8 pcs. per dimension)
- End caps PE d 20-63 mm (4 pcs. per dimension)
- Power supply cable 230 V (1 pcs.)
- Extension cable for remote weld device (1 pcs.)
- Extension cable for heater (1 pcs.)
- Extension cable for facing tool (1 pcs.)
- Cleaning brush No. 8 (1 pcs.)
- Hexagon key 3 mm (1 pcs.)
- Hexagon key 4 mm (1 pcs.)
- Heater protection shield (1 pcs.)
- Clamping unit extension (8 pcs.)
- Socket wrench (facing blades) (1 pcs.)
- Screw driver, Size 0 (1 pcs.)
- HP-Accessory Tray (1 pcs.)
- Manual (1 pcs.)

d-d [mm]	Code	kg	
20 - 63	790 131 005	52.000	

IR-225 Plus® Fusion Jointing Machine and Accessories



IR-225 Plus® Fully-Equipped Machine with HP Working Table (HP = High Purity)

Fully-equipped fusion jointing machine for welding SYGEF® Standard, SYGEF® Plus, DEKAPROP®, PROGEF® Natural, PROGEF® Plus, PE 100 in dimensions d 63-225 mm.

Supply:

1-phase AC (50/60 Hz) 230 V L/N/PE or 3-phase AC (50/60 Hz) 400 V/230 V L1/L2/L3/N/PE

Delivery includes:

- Machine base (1 pcs.)
- Heater assembly (1 pcs.)
- Facing tool (1 pcs.)
- Working table, HP (1 pcs.)
- Movable clamping units (1 pcs.)
- Clamping inserts d 63-225 mm (8 pcs. per dimension)
- End caps PE d 63-225 mm (4 pcs. per dimension)
- Transportation lock (1 pcs.)
- Pipe stop (1 pcs.)
- Hexagon key 5 mm (1 pcs.)
- Hexagon key 6 mm (1 pcs.)
- Combination ring /open-jaw wrench 13 mm (1 pcs.)
- Cleaning brush (1 pcs.)
- Connecting cable 400 V - 230 V (1 pcs.)
- Ball for lever (1 pcs.)
- Manual (1 pcs.)

d-d [mm]	Code	kg	
63 - 225	790 133 009	453.000	

SG 160 Combined butt and socket fusion machine

for fusion jointing PP, PE and PVDF pipes and fittings size range for butt fusion d 32 - 160

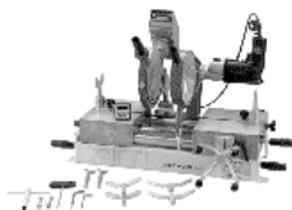

Mobile, very compact and universal plastic fusion machine for use in the workshop and on job sites

Butt fusion d 32 - 160 mm, all pressure ratings up to PN 16.

Socket fusion d 16 - 110 mm

Basic machine

- high precision, distortion-free and robust machine base
- handwheel for easy moving of machine carriage
- exact pressure adjustment via direct load transfer
- hardened, hard-chrome plated guide shafts for extreme loads
- handle for safe transport of machine
- All clamping possibilities for base clamping plates, pipe supports, back stop and prismatic clamping devices.

Planer

- planing device made of light cast aluminium
- optimised cutting geometry for even and chatter-free planing
- powerful parallel planer, swivels in and out for single or double-sided facing of pipe ends 620 W
- integrated pick up for easy mounting of calibration tools for machining of pipe ends in socket fusion

Heater

- high-performance and precision heater with electronic temperature control 1500 W
- high accuracy of +/- 4°C over the entire heating surface
- heater temperature can be set exactly with digital LCD
- high quality, non-stick, easy to change PTFE fabric (Teflon)

Additional standard equipment on the basic model

- V-shaped pipe supports d 16 - 160 mm for fittings
- timer to clock fusion times
- tool set specified to machine

d-d [mm]	Perfor- mance	Code	kg	
16 - 160	230 V	790 103 031	45.000	
16 - 160	115 V	790 103 033	45.000	



for butt fusion jointing of PP, PE and PVDF pipes and fittings

The industrial butt fusion machine for pressure piping systems. Extremely sturdy design use in the workshop and on job sites.

Sizes d 90-315 mm, maximum fusion force 350 daN.

Basic machine

- high precision, distortion-free and robust machine base
- handwheel for easy moving of machine carriage
- fusion pressure is maintained with a user friendly torque limiter
- exact pressure adjustment via direct load transfer
- hardened, hard-chrome plated guide shafts for extreme loads
- handle for safe transport of machine
- optional outer, horizontally removeable clamping devices available

Planer

- optimised cutting geometry for even and chatter-free planing
- powerful parallel planer, swivels in and out for single or double-sided facing of pipe ends, 1100 W
- for your personal safety, a safety switch has been integrated to prevent unintentional start-up in the working position

Heater

- high-performance and precision heater with electronic temperature control 1700 W
- high accuracy of +/- 4°C over the entire heating surface
- heater temperature can be set exactly with digital LCD
- high quality, non-stick, easy to change PTFE coating
- with digital temperature indicator

Additional standard equipment included in the base model

- inner left and right clamping plates, d 315 mm, for pick up of reduction clamping inserts d 90 - 280 mm
- pipe supports d 315 mm for support of fittings
- timer to clock fusion times
- tool set specified to machine

d-d [mm]	Perfor- mance	Code	kg	
90 - 315	230 V	790 130 001	128.000	
90 - 315	115 V	790 130 002	128.000	



MSG 140/63 Socket fusion tool

For the fusion jointing of PP, PE, PB and PVDF pipes and fittings
size range d 16 - 63 mm

- device is equipped with on/off switch, mains control and control lamp for heating intervals
- thermostatic temperature control
- support of heating spigots and bushes from d 16 - 63 mm
- pick up for floor stand or table clamp
- high quality PTFE non-stick coating with long service life
- monitoring and setting of heating element temperature according to DVS 2208
- high temperature accuracy over the entire heating surface
- complete set in a practical metal case
- heating bushes and spigots d 16 - 63 mm
- allen screws and keys

* as long as on stock

d-d [mm]	Perfor- mance	Code	kg	
*16 - 63	230 V/1400	799 350 015	11.700	
*16 - 63	115 V/1400	799 350 019	11.650	

CODE NUMBER

Code	Page
160 480 130	104
161 311 698	120
161 311 699	120
161 311 700	120
161 311 701	120
161 311 702	120
161 311 703	120
161 311 704	126
161 311 710	120
161 311 711	120
161 311 712	120
161 311 713	120
161 311 714	120
161 311 715	120
161 311 728	120
161 311 729	120
161 311 730	120
161 311 731	120
161 311 732	120
161 311 733	120
161 311 734	126
161 480 232	127
161 480 233	127
161 480 238	127
161 480 239	127
161 480 241	126
161 480 242	127
161 480 757	127
161 480 833	104
161 481 022	120
161 481 023	120
161 481 024	120
161 481 025	120
161 481 026	120
161 481 027	120
161 481 028	126
161 481 029	127
161 481 030	127
161 481 759	127
161 481 926	120
161 481 927	120
161 481 928	120
161 481 929	120
161 481 930	120
161 481 931	120
161 481 932	126
161 482 516	127
161 482 517	127
161 482 744	127
161 482 751	127
161 482 754	127
161 482 760	127
161 482 883	104
161 482 892	104
161 482 906	127
161 483 020	127
161 483 021	127
161 483 023	127
161 483 033	127
161 483 034	127
161 483 037	127
161 483 259	151
161 483 260	151
161 483 261	151
161 483 262	151
161 483 263	151
161 483 264	151

Code	Page
161 483 265	151
161 483 266	151
161 483 267	151
161 483 268	151
161 483 269	151
161 483 270	151
161 483 561	158
161 483 562	158
161 483 563	158
161 483 564	158
161 483 565	158
161 483 566	158
161 483 570	159
161 483 571	159
161 484 152	120
161 484 153	120
161 484 154	120
161 484 155	120
161 484 156	120
161 484 157	120
161 484 158	126
161 484 159	127
161 484 160	127
161 484 226	127
161 484 625	120
161 484 626	120
161 484 627	120
161 484 628	120
161 484 629	120
161 484 630	120
161 484 632	126
161 484 633	126
161 484 634	126
161 484 635	126
161 484 636	126
161 484 637	126
161 484 638	126
161 484 688	123
161 484 689	123
161 484 690	123
161 484 691	123
161 484 692	123
161 484 693	123
161 484 696	120
161 484 697	120
161 484 698	120
161 484 699	120
161 484 700	120
161 484 701	120
161 484 702	126
161 484 704	120
161 484 705	120
161 484 706	120
161 484 707	120
161 484 708	120
161 484 709	120
161 484 710	126
161 484 875	155
161 484 876	155
161 484 877	155
161 484 878	155
161 484 879	155
161 484 880	155
161 484 881	155
161 484 882	155
161 484 883	155
161 484 884	155

Code	Page
161 484 885	155
161 484 887	155
161 484 888	155
161 484 889	155
161 484 890	155
161 484 891	155
161 484 892	155
161 484 893	155
161 484 894	155
161 484 895	155
161 484 896	155
161 484 897	155
161 484 900	155
161 484 901	155
161 484 902	155
161 484 903	155
161 484 904	155
161 484 905	155
161 484 906	155
161 484 907	155
161 484 908	155
161 484 909	155
161 484 910	155
161 484 941	116
161 484 942	116
161 484 943	116
161 484 944	116
161 484 945	116
161 484 946	116
161 484 951	116
161 484 952	116
161 484 953	116
161 484 954	116
161 484 955	116
161 484 956	116
161 486 006	142
161 486 007	142
161 486 008	142
161 486 009	142
161 486 010	142
161 486 301	142
161 486 302	142
161 486 303	142
161 486 304	142
161 486 305	142
161 486 325	143
161 486 326	143
161 486 327	143
161 486 328	143
161 486 400	99
161 486 401	99
161 486 402	99
161 486 403	99
161 486 404	99
161 486 405	99
161 486 406	102
161 486 407	102
161 486 408	102
161 486 410	99
161 486 411	99
161 486 412	99
161 486 413	99
161 486 414	99
161 486 415	99
161 486 416	102
161 486 417	102
161 486 418	102

CODE NUMBER

Code	Page
161 486 435	158
161 486 436	158
161 486 437	158
161 486 438	158
161 486 443	157
161 486 444	157
161 486 445	157
161 486 446	157
161 486 690	143
161 486 691	143
161 486 694	143
161 486 695	143
161 486 855	142
161 486 856	142
161 486 857	142
161 486 858	142
161 486 859	142
161 486 899	143
161 486 900	143
161 486 901	143
161 486 902	143
161 486 903	143
161 486 904	143
161 486 905	143
161 486 950	143
161 486 951	143
1613117233	123
163 481 275	99
163 481 276	99
163 481 277	99
163 481 278	99
163 481 279	99
163 481 280	99
163 481 281	99
163 481 286	99
163 481 287	99
163 481 288	99
163 481 289	99
163 481 290	99
163 481 291	99
163 481 292	99
163 481 300	99
163 481 301	99
163 481 302	99
163 481 303	99
163 481 304	99
163 481 305	99
163 481 306	99
163 481 311	99
163 481 312	99
163 481 313	99
163 481 314	99
163 481 315	99
163 481 316	99
163 481 317	99
163 481 322	99
163 481 323	99
163 481 324	99
163 481 325	99
163 481 326	99
163 481 327	99
163 481 328	99
163 481 400	99
163 481 401	99
163 481 402	99
163 481 403	99
163 481 404	99

Code	Page
163 481 405	99
163 481 406	99
167 050 226	52
167 050 227	52
167 050 228	52
167 050 229	52
167 050 230	52
167 050 231	52
167 060 019	222
167 060 020	222
167 060 021	222
167 060 022	222
167 060 023	222
167 060 024	222
167 060 025	222
167 060 038	222
167 060 039	222
167 060 040	222
167 060 041	222
167 060 042	222
167 060 043	222
167 061 035	218
167 061 036	218
167 061 037	218
167 061 038	218
167 061 039	218
167 061 040	218
167 061 041	218
167 061 153	219
167 061 155	219
167 061 156	219
167 061 157	219
167 061 158	219
167 061 159	219
167 061 160	219
167 061 161	219
167 061 162	219
167 061 163	219
167 061 164	219
167 061 165	219
167 061 166	219
167 061 167	219
167 305 000	156
167 305 049	156
167 305 050	156
167 305 099	156
167 305 100	156
167 305 149	156
167 305 150	156
167 305 199	156
167 305 200	156
167 305 249	156
167 305 250	156
167 305 299	156
167 305 300	156
167 305 349	156
167 305 350	156
167 305 399	156
167 305 400	156
167 305 449	156
167 305 450	156
167 305 499	156
167 305 500	156
167 305 549	156
167 305 550	156
167 305 599	156
167 314 402	117

Code	Page
167 314 403	117
167 314 404	117
167 314 405	117
167 314 406	117
167 314 407	117
167 314 417	117
167 314 418	117
167 314 419	117
167 314 420	117
167 314 421	117
167 314 422	117
167 314 432	117
167 314 433	117
167 314 434	117
167 314 435	117
167 314 436	117
167 314 437	117
167 314 447	117
167 314 448	117
167 314 449	117
167 314 450	117
167 314 451	117
167 314 452	117
167 314 462	117
167 314 463	117
167 314 464	117
167 314 465	117
167 314 466	117
167 314 467	117
167 314 477	189
167 314 478	189
167 314 479	189
167 314 480	189
167 314 481	189
167 314 482	189
167 314 492	189
167 314 493	189
167 314 494	189
167 314 495	189
167 314 496	189
167 314 497	189
167 314 502	118
167 314 503	118
167 314 504	118
167 314 505	118
167 314 506	118
167 314 507	118
167 314 517	118
167 314 518	118
167 314 519	118
167 314 520	118
167 314 521	118
167 314 522	118
167 314 532	118
167 314 533	118
167 314 534	118
167 314 535	118
167 314 536	118
167 314 537	118
167 314 547	118
167 314 548	118
167 314 549	118
167 314 550	118
167 314 551	118
167 314 552	118
167 314 562	118
167 314 563	118

CODE NUMBER

Code	Page
167 314 564	118
167 314 565	118
167 314 566	118
167 314 567	118
167 314 577	190
167 314 578	190
167 314 579	190
167 314 580	190
167 314 581	190
167 314 582	190
167 314 592	190
167 314 593	190
167 314 594	190
167 314 595	190
167 314 596	190
167 314 597	190
167 314 602	118
167 314 603	118
167 314 604	118
167 314 605	118
167 314 606	118
167 314 607	118
167 314 617	118
167 314 618	118
167 314 619	118
167 314 620	118
167 314 621	118
167 314 622	118
167 314 632	118
167 314 633	118
167 314 634	118
167 314 635	118
167 314 636	118
167 314 637	118
167 314 647	118
167 314 648	118
167 314 649	118
167 314 650	118
167 314 651	118
167 314 652	118
167 314 662	118
167 314 663	118
167 314 664	118
167 314 665	118
167 314 666	118
167 314 667	118
167 314 702	119
167 314 703	119
167 314 704	119
167 314 705	119
167 314 706	119
167 314 707	119
167 314 717	119
167 314 718	119
167 314 719	119
167 314 720	119
167 314 721	119
167 314 722	119
167 314 732	119
167 314 733	119
167 314 734	119
167 314 735	119
167 314 736	119
167 314 737	119
167 314 747	119
167 314 748	119
167 314 749	119

Code	Page
167 314 750	119
167 314 751	119
167 314 752	119
167 314 762	119
167 314 763	119
167 314 764	119
167 314 765	119
167 314 766	119
167 314 767	119
167 315 402	121
167 315 403	121
167 315 404	121
167 315 405	121
167 315 406	121
167 315 407	121
167 315 417	121
167 315 418	121
167 315 419	121
167 315 420	121
167 315 421	121
167 315 422	121
167 315 432	121
167 315 433	121
167 315 434	121
167 315 435	121
167 315 436	121
167 315 437	121
167 315 447	121
167 315 448	121
167 315 449	121
167 315 450	121
167 315 451	121
167 315 452	121
167 315 492	121
167 315 493	121
167 315 494	121
167 315 495	121
167 315 496	121
167 315 497	121
167 315 502	121
167 315 503	121
167 315 504	121
167 315 505	121
167 315 506	121
167 315 507	121
167 315 517	121
167 315 518	121
167 315 519	121
167 315 520	121
167 315 521	121
167 315 522	121
167 315 532	121
167 315 533	121
167 315 534	121
167 315 535	121
167 315 536	121
167 315 537	121
167 315 547	121
167 315 548	121
167 315 549	121
167 315 550	121
167 315 551	121
167 315 552	121
167 315 562	191
167 315 563	191
167 315 564	191
167 315 565	191

Code	Page
167 315 566	191
167 315 567	191
167 315 577	191
167 315 578	191
167 315 579	191
167 315 580	191
167 315 581	191
167 315 582	191
167 315 592	122
167 315 593	122
167 315 594	122
167 315 595	122
167 315 596	122
167 315 597	122
167 317 009	125
167 317 010	125
167 317 025	125
167 317 039	125
167 317 040	125
167 317 054	125
167 317 055	125
167 317 129	192
167 317 130	192
167 317 132	192
167 317 144	192
167 317 145	192
167 317 147	192
167 317 152	125
167 317 153	125
167 317 154	125
167 317 155	125
167 317 156	125
167 317 157	125
167 317 158	125
167 317 167	125
167 317 168	125
167 317 169	125
167 317 170	125
167 317 171	125
167 317 172	125
167 317 173	125
167 317 182	125
167 317 183	125
167 317 184	125
167 317 185	125
167 317 186	125
167 317 187	125
167 317 188	125
167 317 197	125
167 317 198	125
167 317 199	125
167 317 200	125
167 317 201	125
167 317 202	125
167 317 203	125
167 317 212	192
167 317 213	192
167 317 214	192
167 317 215	192
167 317 216	192
167 317 217	192
167 317 218	192
167 317 227	192
167 317 228	192
167 317 229	192
167 317 230	192
167 317 231	192

CODE NUMBER

Code	Page
167 317 232	192
167 317 233	192
167 317 272	124
167 317 273	124
167 317 274	124
167 317 275	124
167 317 276	124
167 317 277	124
167 317 278	124
167 319 301	128
167 319 303	128
167 319 304	128
167 319 307	128
167 319 308	128
167 319 309	128
167 319 312	128
167 319 318	128
167 319 319	128
167 319 320	128
167 319 325	128
167 319 326	128
167 319 327	128
167 319 341	128
167 319 342	128
167 319 343	128
167 319 345	128
167 319 346	128
167 319 351	128
167 319 352	128
167 319 353	128
167 319 355	128
167 319 356	128
167 319 601	193
167 319 603	193
167 319 604	193
167 319 607	193
167 319 608	193
167 319 609	193
167 319 612	193
167 319 618	193
167 319 619	193
167 319 620	193
167 319 625	193
167 319 626	193
167 319 627	193
167 319 641	193
167 319 642	193
167 319 643	193
167 319 645	193
167 319 646	193
167 319 651	193
167 319 652	193
167 319 653	193
167 319 655	193
167 319 656	193
167 323 401	103
167 323 402	103
167 323 411	103
167 323 412	103
167 323 441	103
167 323 442	103
167 323 451	103
167 323 452	103
167 323 482	103
167 323 492	103
167 343 001	105
167 343 002	105

Code	Page
167 343 003	105
167 343 004	105
167 343 005	105
167 343 006	105
167 343 007	105
167 343 011	105
167 343 012	105
167 343 013	105
167 343 014	105
167 343 015	105
167 343 016	105
167 343 017	105
167 343 021	106
167 343 022	106
167 343 023	106
167 343 024	106
167 343 025	106
167 343 026	106
167 343 027	106
167 343 031	106
167 343 032	106
167 343 033	106
167 343 034	106
167 343 035	106
167 343 036	106
167 343 037	106
167 343 042	108
167 343 043	108
167 343 044	108
167 343 045	108
167 343 046	108
167 343 047	108
167 343 052	108
167 343 053	108
167 343 054	108
167 343 055	108
167 343 056	108
167 343 057	108
167 343 062	107
167 343 063	107
167 343 064	107
167 343 065	107
167 343 066	107
167 343 067	107
167 343 072	107
167 343 073	107
167 343 074	107
167 343 075	107
167 343 076	107
167 343 077	107
167 343 081	106
167 343 082	106
167 343 083	106
167 343 084	106
167 343 085	106
167 343 086	106
167 343 087	106
167 343 091	106
167 343 092	106
167 343 093	106
167 343 094	106
167 343 095	106
167 343 096	106
167 343 097	106
167 343 161	107
167 343 162	107
167 343 163	107

Code	Page
167 343 164	107
167 343 165	107
167 343 166	107
167 343 167	107
167 343 171	107
167 343 172	107
167 343 173	107
167 343 174	107
167 343 175	107
167 343 176	107
167 343 177	107
167 343 201	109
167 343 202	109
167 343 203	109
167 343 204	109
167 343 205	109
167 343 206	109
167 343 207	109
167 343 211	109
167 343 212	109
167 343 213	109
167 343 214	109
167 343 215	109
167 343 216	109
167 343 217	109
167 343 221	110
167 343 222	110
167 343 223	110
167 343 224	110
167 343 225	110
167 343 226	110
167 343 227	110
167 343 231	110
167 343 232	110
167 343 233	110
167 343 234	110
167 343 235	110
167 343 236	110
167 343 237	110
167 343 242	113
167 343 243	113
167 343 244	113
167 343 245	113
167 343 246	113
167 343 247	113
167 343 252	113
167 343 253	113
167 343 254	113
167 343 255	113
167 343 256	113
167 343 257	113
167 343 262	113
167 343 263	113
167 343 264	113
167 343 265	113
167 343 266	113
167 343 267	113
167 343 272	113
167 343 273	113
167 343 274	113
167 343 275	113
167 343 276	113
167 343 277	113
167 343 281	111
167 343 282	111
167 343 283	111
167 343 284	111

CODE NUMBER

Code	Page
167 343 285	111
167 343 286	111
167 343 287	111
167 343 291	111
167 343 292	111
167 343 293	111
167 343 294	111
167 343 295	111
167 343 296	111
167 343 297	111
167 343 361	112
167 343 362	112
167 343 363	112
167 343 364	112
167 343 365	112
167 343 366	112
167 343 367	112
167 343 371	112
167 343 372	112
167 343 373	112
167 343 374	112
167 343 375	112
167 343 376	112
167 343 377	112
167 360 401	146
167 360 402	146
167 360 403	146
167 360 404	146
167 360 405	146
167 360 406	146
167 360 407	146
167 360 411	146
167 360 412	146
167 360 413	146
167 360 414	146
167 360 415	146
167 360 416	146
167 360 417	146
167 360 421	148
167 360 422	148
167 360 423	148
167 360 424	148
167 360 425	148
167 360 426	148
167 360 427	148
167 360 431	148
167 360 432	148
167 360 433	148
167 360 434	148
167 360 435	148
167 360 436	148
167 360 437	148
167 360 441	146
167 360 442	146
167 360 443	146
167 360 444	146
167 360 445	146
167 360 446	146
167 360 447	146
167 360 451	146
167 360 452	146
167 360 453	146
167 360 454	146
167 360 455	146
167 360 456	146
167 360 457	146
167 360 463	147

Code	Page
167 360 464	147
167 360 465	147
167 360 466	147
167 360 467	147
167 360 473	147
167 360 474	147
167 360 475	147
167 360 476	147
167 360 477	147
167 360 482	147
167 360 483	147
167 360 484	147
167 360 485	147
167 360 486	147
167 360 487	147
167 360 492	147
167 360 493	147
167 360 494	147
167 360 495	147
167 360 496	147
167 360 497	147
167 360 502	148
167 360 503	148
167 360 504	148
167 360 505	148
167 360 506	148
167 360 507	148
167 360 512	148
167 360 513	148
167 360 514	148
167 360 515	148
167 360 516	148
167 360 517	148
167 360 581	149
167 360 582	149
167 360 583	149
167 360 584	149
167 360 585	149
167 360 586	149
167 360 587	149
167 360 591	149
167 360 592	149
167 360 593	149
167 360 594	149
167 360 595	149
167 360 596	149
167 360 597	149
167 360 601	197
167 360 602	197
167 360 603	197
167 360 604	197
167 360 605	197
167 360 606	197
167 360 607	197
167 360 611	197
167 360 612	197
167 360 613	197
167 360 614	197
167 360 615	197
167 360 616	197
167 360 617	197
167 360 621	197
167 360 622	197
167 360 623	197
167 360 624	197
167 360 625	197
167 360 626	197

Code	Page
167 360 627	197
167 360 631	197
167 360 632	197
167 360 633	197
167 360 634	197
167 360 635	197
167 360 636	197
167 360 637	197
167 360 642	198
167 360 643	198
167 360 644	198
167 360 645	198
167 360 646	198
167 360 647	198
167 360 652	198
167 360 653	198
167 360 654	198
167 360 655	198
167 360 656	198
167 360 657	198
167 360 665	150
167 360 666	150
167 360 667	150
167 360 675	150
167 360 676	150
167 360 677	150
167 360 682	150
167 360 683	150
167 360 684	150
167 360 685	150
167 360 686	150
167 360 687	150
167 360 692	150
167 360 693	150
167 360 694	150
167 360 695	150
167 360 696	150
167 360 697	150
167 360 721	149
167 360 722	149
167 360 723	149
167 360 724	149
167 360 725	149
167 360 726	149
167 360 727	149
167 360 731	149
167 360 732	149
167 360 733	149
167 360 734	149
167 360 735	149
167 360 736	149
167 360 737	149
167 367 011	140
167 367 012	140
167 367 031	140
167 367 032	140
167 367 091	140
167 367 092	140
167 367 111	140
167 367 112	140
167 367 131	141
167 367 132	141
167 367 151	141
167 367 152	141
167 367 251	141
167 367 252	141
167 367 271	141

CODE NUMBER

Code	Page
167 367 272	141
167 369 002	152
167 369 003	152
167 369 004	152
167 369 005	152
167 369 006	152
167 369 007	152
167 369 009	152
167 369 010	152
167 369 011	152
167 369 012	152
167 369 013	152
167 369 022	152
167 369 023	152
167 369 024	152
167 369 025	152
167 369 026	152
167 369 027	152
167 369 029	152
167 369 030	152
167 369 031	152
167 369 032	152
167 369 033	152
167 369 042	153
167 369 043	153
167 369 044	153
167 369 045	153
167 369 046	153
167 369 047	153
167 369 049	153
167 369 050	153
167 369 051	153
167 369 052	153
167 369 053	153
167 369 062	153
167 369 063	153
167 369 064	153
167 369 065	153
167 369 066	153
167 369 067	153
167 369 069	153
167 369 070	153
167 369 071	153
167 369 072	153
167 369 073	153
167 369 082	154
167 369 083	154
167 369 084	154
167 369 085	154
167 369 086	154
167 369 087	154
167 369 089	154
167 369 090	154
167 369 091	154
167 369 092	154
167 369 093	154
167 369 102	154
167 369 103	154
167 369 104	154
167 369 105	154
167 369 106	154
167 369 107	154
167 369 109	154
167 369 110	154
167 369 111	154
167 369 112	154
167 369 113	154

Code	Page
167 480 159	104
167 480 160	104
167 480 161	116
167 480 162	116
167 480 163	116
167 480 164	116
167 480 165	116
167 480 166	116
167 480 167	116
167 480 168	116
167 480 169	116
167 480 170	116
167 480 171	116
167 480 172	116
167 480 328	123
167 480 329	123
167 480 330	123
167 480 331	123
167 480 332	123
167 480 333	123
167 480 422	160
167 480 423	160
167 480 424	160
167 480 425	160
167 480 426	160
167 480 427	127
167 480 428	127
167 480 452	116
167 480 453	116
167 480 454	116
167 480 455	116
167 480 456	116
167 480 457	116
167 480 458	116
167 480 519	104
167 480 527	104
167 480 528	104
167 480 529	116
167 480 530	116
167 480 531	116
167 480 532	116
167 480 533	116
167 480 537	116
167 480 538	116
167 480 539	116
167 480 540	116
167 480 541	116
167 480 542	116
167 480 546	104
167 480 547	116
167 480 548	116
167 480 549	116
167 480 550	116
167 480 551	116
167 480 577	127
167 480 680	43
167 480 681	43
167 480 682	43
167 480 683	43
167 480 684	43
167 480 685	43
167 480 686	43
167 480 687	43
167 480 688	43
167 480 689	43
167 480 690	43
167 480 691	43

Code	Page
167 480 692	43
167 480 693	43
167 480 694	43
167 480 695	43
167 480 710	42
167 480 711	42
167 480 712	42
167 480 713	42
167 480 714	42
167 480 715	42
167 480 716	42
167 480 717	42
167 480 718	42
167 480 719	42
167 480 720	42
167 480 721	42
167 480 722	42
167 480 723	42
167 480 724	42
167 480 725	42
167 480 726	42
167 480 727	42
167 480 728	42
167 480 729	42
167 480 730	42
167 480 786	104
167 480 787	116
167 480 788	116
167 480 789	116
167 480 790	116
167 480 791	116
167 480 901	104
167 480 902	104
167 480 904	104
167 481 028	43
167 481 029	43
167 481 125	151
167 481 126	151
167 481 127	151
167 481 128	151
167 481 129	151
167 481 130	151
167 481 131	151
167 481 135	151
167 481 136	151
167 481 137	151
167 481 138	151
167 481 139	151
167 481 140	151
167 481 141	151
167 481 165	151
167 481 166	151
167 481 167	151
167 481 168	151
167 481 169	151
167 481 170	151
167 481 711	178
167 481 712	178
167 481 713	178
167 481 714	178
167 481 715	178
167 481 716	178
167 481 717	178
167 481 718	178
167 481 719	178
167 481 720	178
167 481 721	178

CODE NUMBER

Code	Page
167 481 722	178
167 481 723	178
167 481 724	178
167 481 725	178
167 481 726	178
167 481 727	178
167 481 728	178
167 481 977	120
167 481 978	120
167 481 979	120
167 481 980	120
167 481 981	120
167 481 982	120
167 482 137	116
167 482 138	116
167 482 139	116
167 482 140	116
167 482 141	116
167 482 142	116
167 482 148	116
167 482 149	116
167 482 150	116
167 482 151	116
167 482 152	116
167 482 153	116
167 482 159	116
167 482 160	116
167 482 161	116
167 482 162	116
167 482 163	116
167 482 164	116
167 482 170	116
167 482 171	116
167 482 172	116
167 482 173	116
167 482 174	116
167 482 175	116
167 482 190	116
167 482 191	116
167 482 192	116
167 482 193	116
167 482 194	116
167 482 195	116
167 482 202	116
167 482 203	116
167 482 204	116
167 482 205	116
167 482 206	116
167 482 207	116
167 482 214	116
167 482 215	116
167 482 216	116
167 482 217	116
167 482 218	116
167 482 219	116
167 482 226	116
167 482 227	116
167 482 228	116
167 482 229	116
167 482 230	116
167 482 231	116
167 482 546	116
167 482 547	116
167 482 548	116
167 482 549	116
167 482 550	116
167 482 551	116

Code	Page
167 482 712	99
167 482 713	99
167 482 714	99
167 482 715	99
167 482 716	99
167 482 717	99
167 482 718	102
167 482 719	102
167 482 720	102
167 482 876	99
167 482 877	99
167 482 878	99
167 482 879	99
167 482 880	99
167 482 881	99
167 482 882	102
167 482 883	102
167 482 884	102
167 482 888	99
167 482 889	99
167 482 890	99
167 482 891	99
167 482 892	99
167 482 893	99
167 482 894	102
167 482 895	102
167 482 896	102
167 482 900	99
167 482 901	99
167 482 902	99
167 482 903	99
167 482 904	99
167 482 905	99
167 482 906	99
167 482 907	102
167 482 908	102
167 482 909	102
167 482 911	99
167 482 912	99
167 482 913	99
167 482 914	99
167 482 915	99
167 482 916	99
167 482 917	99
167 482 922	99
167 482 923	99
167 482 924	99
167 482 925	99
167 482 926	99
167 482 927	99
167 482 928	99
167 482 929	102
167 482 930	102
167 482 931	102
167 482 937	99
167 482 938	99
167 482 939	99
167 482 940	102
167 482 941	102
167 482 942	102
167 482 945	99
167 482 946	99
167 482 947	99
167 482 948	99
167 482 949	99
167 482 950	99
167 482 951	102

Code	Page
167 482 952	102
167 482 953	102
167 482 956	99
167 482 957	99
167 482 958	99
167 482 959	99
167 482 960	99
167 482 961	99
167 482 966	99
167 482 967	99
167 482 968	99
167 482 969	99
167 482 970	99
167 482 971	99
167 482 972	99
167 483 226	144
167 483 227	144
167 483 228	144
167 483 229	144
167 483 230	144
167 483 231	144
167 483 232	144
167 483 251	143
167 483 252	143
167 483 253	143
167 484 025	102
167 484 026	102
167 484 027	102
167 484 028	126
167 484 029	126
167 484 030	126
167 484 031	126
167 484 071	102
167 484 072	102
167 484 073	102
167 484 076	99
167 484 077	99
167 484 078	99
167 484 079	99
167 484 080	99
167 484 081	99
167 484 082	102
167 484 083	102
167 484 084	102
167 484 088	99
167 484 089	99
167 484 090	99
167 484 091	99
167 484 092	99
167 484 093	99
167 484 094	102
167 484 095	102
167 484 096	102
167 484 100	99
167 484 101	99
167 484 102	99
167 484 103	99
167 484 104	99
167 484 105	99
167 484 110	157
167 484 111	157
167 484 125	99
167 484 126	99
167 484 127	99
167 484 128	99
167 484 129	99
167 484 130	99

CODE NUMBER

Code	Page
167 484 131	102
167 484 132	102
167 484 133	102
167 484 135	99
167 484 136	99
167 484 137	99
167 484 138	99
167 484 139	99
167 484 140	99
167 484 141	102
167 484 142	102
167 484 143	102
167 484 160	99
167 484 161	99
167 484 162	99
167 484 163	99
167 484 164	99
167 484 165	99
167 484 259	144
167 484 260	144
167 484 261	144
167 484 265	144
167 484 266	144
167 484 267	144
167 484 271	144
167 484 272	144
167 484 273	144
167 484 274	144
167 484 275	144
167 484 276	144
167 484 277	144
167 484 286	144
167 484 287	144
167 484 288	144
167 484 289	144
167 484 290	144
167 484 291	144
167 484 292	144
167 484 418	102
167 484 419	102
167 484 420	102
167 546 001	79
167 546 002	79
167 546 003	79
167 546 004	79
167 546 005	79
167 546 006	79
167 546 007	79
167 546 008	79
167 546 009	79
167 546 010	79
167 546 011	79
167 546 012	79
167 546 013	79
167 546 014	79
167 546 015	79
167 546 016	79
167 546 017	79
167 546 018	79
167 546 019	79
167 546 020	79
167 546 021	82
167 546 022	82
167 546 023	82
167 546 024	82
167 546 025	82
167 546 026	82

Code	Page
167 546 027	82
167 546 031	82
167 546 032	82
167 546 033	82
167 546 034	82
167 546 035	82
167 546 036	82
167 546 037	82
167 546 041	81
167 546 042	81
167 546 043	81
167 546 044	81
167 546 045	81
167 546 046	81
167 546 047	81
167 546 048	81
167 546 049	81
167 546 050	81
167 546 051	81
167 546 052	81
167 546 053	81
167 546 054	81
167 546 055	81
167 546 056	81
167 546 057	81
167 546 058	81
167 546 059	81
167 546 060	81
167 546 066	91
167 546 067	91
167 546 068	91
167 546 069	91
167 546 070	91
167 546 076	91
167 546 077	91
167 546 078	91
167 546 079	91
167 546 080	91
167 546 126	86
167 546 127	86
167 546 136	86
167 546 137	86
167 546 142	85
167 546 143	85
167 546 144	85
167 546 145	85
167 546 146	85
167 546 147	85
167 546 152	85
167 546 153	85
167 546 154	85
167 546 155	85
167 546 156	85
167 546 157	85
167 546 161	90
167 546 162	90
167 546 163	90
167 546 164	90
167 546 165	90
167 546 166	90
167 546 167	90
167 546 171	90
167 546 172	90
167 546 173	90
167 546 174	90
167 546 175	90
167 546 176	90

Code	Page
167 546 177	90
167 546 182	84
167 546 183	84
167 546 184	84
167 546 185	84
167 546 186	84
167 546 187	84
167 546 192	84
167 546 193	84
167 546 194	84
167 546 195	84
167 546 196	84
167 546 197	84
167 546 262	89
167 546 263	89
167 546 264	89
167 546 265	89
167 546 266	89
167 546 267	89
167 546 272	89
167 546 273	89
167 546 274	89
167 546 275	89
167 546 276	89
167 546 277	89
167 546 282	87
167 546 283	87
167 546 284	87
167 546 285	87
167 546 286	87
167 546 287	87
167 546 288	87
167 546 289	87
167 546 290	87
167 546 292	87
167 546 293	87
167 546 294	87
167 546 295	87
167 546 296	87
167 546 297	87
167 546 298	87
167 546 299	87
167 546 300	87
167 546 308	92
167 546 309	92
167 546 310	92
167 546 318	92
167 546 319	92
167 546 320	92
167 546 321	83
167 546 322	83
167 546 323	83
167 546 324	83
167 546 325	83
167 546 326	83
167 546 327	83
167 546 331	83
167 546 332	83
167 546 333	83
167 546 334	83
167 546 335	83
167 546 336	83
167 546 337	83
167 546 401	80
167 546 402	80
167 546 403	80
167 546 404	80

CODE NUMBER

Code	Page
167 546 405	80
167 546 406	80
167 546 407	80
167 546 408	80
167 546 409	80
167 546 410	80
167 546 411	80
167 546 412	80
167 546 413	80
167 546 414	80
167 546 415	80
167 546 416	80
167 546 417	80
167 546 418	80
167 546 419	80
167 546 420	80
167 546 421	94
167 546 422	94
167 546 423	94
167 546 424	94
167 546 425	94
167 546 426	94
167 546 427	94
167 546 428	94
167 546 429	94
167 546 430	94
167 546 431	94
167 546 432	94
167 546 433	94
167 546 434	94
167 546 435	94
167 546 436	94
167 546 437	94
167 546 438	94
167 546 439	94
167 546 440	94
167 546 442	88
167 546 443	88
167 546 444	88
167 546 445	88
167 546 446	88
167 546 447	88
167 546 448	88
167 546 449	88
167 546 450	88
167 546 452	88
167 546 453	88
167 546 454	88
167 546 455	88
167 546 456	88
167 546 457	88
167 546 458	88
167 546 459	88
167 546 460	88
167 546 462	95
167 546 463	95
167 546 464	95
167 546 465	95
167 546 466	95
167 546 467	95
167 546 468	95
167 546 469	95
167 546 470	95
167 546 472	95
167 546 473	95
167 546 474	95
167 546 475	95

Code	Page
167 546 476	95
167 546 477	95
167 546 478	95
167 546 479	95
167 546 480	95
167 546 601	186
167 546 602	186
167 546 603	186
167 546 604	186
167 546 605	186
167 546 606	186
167 546 607	186
167 546 611	186
167 546 612	186
167 546 613	186
167 546 614	186
167 546 615	186
167 546 616	186
167 546 617	186
167 546 621	187
167 546 622	187
167 546 623	187
167 546 624	187
167 546 625	187
167 546 626	187
167 546 627	187
167 546 631	187
167 546 632	187
167 546 633	187
167 546 634	187
167 546 635	187
167 546 636	187
167 546 637	187
167 546 662	188
167 546 663	188
167 546 664	188
167 546 665	188
167 546 666	188
167 546 667	188
167 546 672	188
167 546 673	188
167 546 674	188
167 546 675	188
167 546 676	188
167 546 677	188
167 546 808	93
167 546 809	93
167 546 810	93
167 546 818	93
167 546 819	93
167 546 820	93
167 567 002	131
167 567 003	131
167 567 004	131
167 567 005	131
167 567 006	131
167 567 007	131
167 567 008	131
167 567 022	131
167 567 023	131
167 567 024	131
167 567 025	131
167 567 026	131
167 567 027	131
167 567 028	131
167 567 042	132
167 567 043	132

Code	Page
167 567 044	132
167 567 045	132
167 567 046	132
167 567 047	132
167 567 048	132
167 567 062	132
167 567 063	132
167 567 064	132
167 567 065	132
167 567 066	132
167 567 067	132
167 567 068	132
167 567 402	194
167 567 403	194
167 567 404	194
167 567 405	194
167 567 406	194
167 567 407	194
167 567 408	194
167 567 422	194
167 567 423	194
167 567 424	194
167 567 425	194
167 567 426	194
167 567 427	194
167 567 428	194
167 567 802	133
167 567 803	133
167 567 804	133
167 567 805	133
167 567 806	133
167 567 807	133
167 567 808	133
167 567 822	133
167 567 823	133
167 567 824	133
167 567 825	133
167 567 826	133
167 567 827	133
167 567 828	133
167 568 002	134
167 568 003	134
167 568 004	134
167 568 005	134
167 568 006	134
167 568 007	134
167 568 008	134
167 568 022	134
167 568 023	134
167 568 024	134
167 568 025	134
167 568 026	134
167 568 027	134
167 568 028	134
167 568 042	135
167 568 043	135
167 568 044	135
167 568 045	135
167 568 046	135
167 568 047	135
167 568 048	135
167 568 062	135
167 568 063	135
167 568 064	135
167 568 065	135
167 568 066	135
167 568 067	135

CODE NUMBER

Code	Page
167 568 068	135
167 568 102	137
167 568 103	137
167 568 104	137
167 568 105	137
167 568 106	137
167 568 107	137
167 568 108	137
167 568 122	137
167 568 123	137
167 568 124	137
167 568 125	137
167 568 126	137
167 568 127	137
167 568 128	137
167 568 142	138
167 568 143	138
167 568 144	138
167 568 145	138
167 568 146	138
167 568 147	138
167 568 148	138
167 568 162	138
167 568 163	138
167 568 164	138
167 568 165	138
167 568 166	138
167 568 167	138
167 568 168	138
167 568 402	195
167 568 403	195
167 568 404	195
167 568 405	195
167 568 406	195
167 568 407	195
167 568 408	195
167 568 422	195
167 568 423	195
167 568 424	195
167 568 425	195
167 568 426	195
167 568 427	195
167 568 428	195
167 568 502	196
167 568 503	196
167 568 504	196
167 568 505	196
167 568 506	196
167 568 507	196
167 568 508	196
167 568 522	196
167 568 523	196
167 568 524	196
167 568 525	196
167 568 526	196
167 568 527	196
167 568 528	196
167 568 802	136
167 568 803	136
167 568 804	136
167 568 805	136
167 568 806	136
167 568 807	136
167 568 808	136
167 568 822	136
167 568 823	136
167 568 824	136

Code	Page
167 568 825	136
167 568 826	136
167 568 827	136
167 568 828	136
167 568 902	139
167 568 903	139
167 568 904	139
167 568 905	139
167 568 906	139
167 568 907	139
167 568 908	139
167 568 922	139
167 568 923	139
167 568 924	139
167 568 925	139
167 568 926	139
167 568 927	139
167 568 928	139
168 315 532	173
168 315 533	173
168 315 534	173
168 315 535	173
168 315 536	173
168 315 537	173
168 317 025	173
168 317 324	173
168 317 325	173
168 319 401	174
168 319 403	174
168 319 404	174
168 319 407	174
168 319 408	174
168 319 409	174
168 319 412	174
168 319 418	174
168 319 419	174
168 319 420	174
168 319 425	174
168 319 426	174
168 319 427	174
168 319 441	174
168 319 442	174
168 319 443	174
168 319 445	174
168 319 446	174
168 319 451	174
168 319 452	174
168 319 453	174
168 319 455	174
168 319 456	174
168 319 501	175
168 319 503	175
168 319 504	175
168 319 507	175
168 319 508	175
168 319 509	175
168 319 512	175
168 319 513	175
168 319 514	175
168 319 515	175
168 319 518	175
168 319 519	175
168 319 520	175
168 319 525	175
168 319 526	175
168 319 527	175
168 319 541	175

Code	Page
168 319 542	175
168 319 543	175
168 319 545	175
168 319 546	175
168 319 551	175
168 319 552	175
168 319 553	175
168 319 555	175
168 319 556	175
168 480 151	162
168 480 152	162
168 480 153	162
168 480 154	162
168 480 155	162
168 480 156	162
168 480 177	129
168 480 179	129
168 480 180	129
168 480 182	129
168 480 183	129
168 480 184	129
168 480 186	129
168 480 191	130
168 480 192	130
168 480 193	130
168 480 197	130
168 480 198	130
168 480 199	130
168 480 260	172
168 480 261	172
168 480 262	172
168 480 263	172
168 480 264	172
168 480 265	172
168 480 282	162
168 480 283	162
168 480 284	162
173 061 003	220
173 061 004	220
173 061 005	220
173 061 006	220
173 061 007	220
173 061 008	220
173 061 009	220
173 061 010	220
173 061 011	220
173 061 012	220
173 061 013	220
173 061 014	220
173 061 015	220
173 061 016	220
173 061 017	220
173 061 153	221
173 061 155	221
173 061 156	221
173 061 157	221
173 061 158	221
173 061 159	221
173 061 160	221
173 061 161	221
173 061 162	221
173 061 163	221
173 061 164	221
173 061 165	221
173 061 166	221
173 061 167	221
173 480 000	104

CODE NUMBER

Code	Page
173 480 001	104
173 480 002	116
173 480 003	116
173 480 004	116
173 480 005	116
173 480 006	116
193 480 014	116
193 480 015	116
193 480 016	116
193 480 017	116
193 480 018	116
193 480 026	116
193 480 027	116
193 480 028	116
193 480 029	116
193 480 030	116
193 480 031	116
193 480 032	116
193 480 086	99
193 480 087	99
193 480 088	99
193 480 102	99
193 480 103	99
193 480 104	99
193 480 105	99
193 480 106	99
193 480 107	99
193 480 127	116
193 480 128	116
193 480 129	116
193 480 130	116
193 480 131	116
193 480 132	116
193 480 152	99
193 480 153	99
193 480 154	99
193 480 155	99
193 480 156	99
193 480 157	99
193 480 158	102
193 480 159	102
193 480 160	102
193 480 168	102
193 480 169	102
193 480 170	102
193 480 175	99
193 480 176	99
193 480 177	99
193 480 178	99
193 480 179	99
193 480 180	99
193 480 181	99
197 480 905	104
720 630 605	76
720 630 606	76
720 630 607	76
720 630 608	76
720 630 609	76
720 630 610	76
720 630 611	76
720 630 612	76
720 630 613	76
720 630 905	76
720 630 906	76
720 630 907	76
720 630 908	76
720 630 909	76

Code	Page
720 630 910	76
720 630 911	76
720 630 912	76
720 630 913	76
720 690 005	78
720 690 006	78
720 690 007	78
720 690 008	78
720 690 009	78
720 690 010	78
720 690 011	78
720 690 012	78
720 690 013	78
720 690 405	78
724 600 655	74
724 600 656	74
724 600 657	74
724 600 658	74
724 600 659	74
724 600 660	74
724 600 661	74
724 600 705	74
724 600 706	74
724 600 707	74
724 600 708	74
724 600 709	74
724 600 710	74
724 600 711	74
724 605 505	74
724 605 506	74
724 605 507	74
724 605 508	74
724 605 509	74
724 605 510	74
724 605 511	74
724 630 608	75
724 630 609	75
724 630 610	75
724 630 611	75
724 630 612	75
724 630 613	75
724 630 906	75
724 630 907	75
724 630 908	75
724 630 909	75
724 630 910	75
724 630 911	75
724 630 912	75
724 630 913	75
724 690 006	77
724 690 007	77
724 690 008	77
724 690 009	77
724 690 010	77
724 690 011	77
724 690 105	78
724 690 106	78
724 690 107	78
724 690 108	78
724 690 109	78
724 690 110	78
724 690 111	78
724 700 014	206
724 700 319	212
724 700 320	212
724 700 321	212
724 700 322	212

Code	Page
724 700 323	212
724 700 324	212
724 700 325	212
724 700 424	211
724 700 425	211
724 700 426	211
724 700 427	211
724 700 428	211
724 700 429	211
724 700 914	208
724 700 915	208
724 700 916	208
724 700 917	208
724 700 918	208
724 700 919	208
724 700 920	208
724 700 921	208
724 700 922	208
724 700 923	208
724 700 924	208
724 700 925	208
724 701 406	206
724 701 407	206
724 701 408	206
724 701 409	206
724 701 410	206
724 701 411	206
724 701 412	206
724 701 413	206
724 701 415	206
724 701 416	206
724 701 417	206
724 701 419	206
724 701 606	206
724 701 607	206
724 701 608	206
724 701 609	206
724 701 610	206
724 701 611	206
724 701 612	206
724 701 613	206
724 701 615	206
724 701 616	206
724 701 617	206
724 701 620	206
724 701 720	206
724 701 806	207
724 701 807	207
724 701 808	207
724 701 809	207
724 701 810	207
724 701 811	207
724 701 812	207
724 701 813	207
724 701 815	207
724 701 816	207
724 701 817	207
724 701 820	207
724 701 914	209
724 701 915	209
724 701 916	209
724 701 917	209
724 701 919	209
724 701 920	209
724 701 922	209
724 701 923	209
724 703 414	206

CODE NUMBER

Code	Page
724 703 814	207
724 703 914	208
724 703 916	208
724 703 917	208
724 703 919	208
724 703 920	208
724 703 921	208
724 703 922	208
724 703 923	208
727 018 421	55
727 018 422	55
727 018 423	55
727 018 435	55
727 018 436	55
727 018 440	55
727 018 441	55
727 018 442	55
727 018 443	55
727 018 444	55
727 018 445	55
727 018 466	179
727 018 467	179
727 018 468	179
727 018 469	179
727 018 470	179
727 018 471	179
727 018 475	179
727 018 476	179
727 018 477	179
727 018 478	179
727 018 479	179
727 018 480	179
727 018 481	54
727 018 482	54
727 018 483	54
727 018 484	54
727 018 485	54
727 018 486	54
727 018 490	54
727 018 491	54
727 018 492	54
727 018 493	54
727 018 494	54
727 018 495	54
727 018 521	54
727 018 522	54
727 018 523	54
727 018 549	55
727 018 550	55
727 018 574	54
727 018 575	54
727 018 612	54
727 018 613	54
727 018 614	54
727 018 637	55
727 018 638	55
727 018 639	55
727 018 662	179
727 018 663	179
727 018 664	179
727 100 105	44
727 100 106	44
727 100 107	44
727 100 108	44
727 100 109	44
727 100 110	44
727 100 111	44

Code	Page
727 100 112	44
727 100 113	44
727 100 114	44
727 100 206	51
727 100 207	51
727 100 208	51
727 100 209	51
727 108 506	55
727 108 507	55
727 108 508	55
727 108 509	55
727 108 510	55
727 108 511	55
727 108 581	179
727 108 582	179
727 108 583	179
727 108 584	179
727 108 585	179
727 108 586	179
727 150 105	44
727 150 106	44
727 150 107	44
727 150 108	44
727 150 109	44
727 150 110	44
727 150 111	44
727 150 112	44
727 150 113	44
727 150 114	44
727 158 506	56
727 158 507	56
727 158 508	56
727 158 509	56
727 158 510	56
727 158 511	56
727 158 512	56
727 158 513	56
727 158 514	56
727 158 515	56
727 158 516	56
727 158 517	56
727 158 519	56
727 158 520	56
727 158 535	56
727 158 536	56
727 158 537	56
727 158 538	56
727 158 539	56
727 158 540	56
727 158 541	56
727 158 542	56
727 158 544	56
727 158 545	56
727 158 581	180
727 158 582	180
727 158 583	180
727 158 584	180
727 158 585	180
727 158 586	180
727 158 587	180
727 158 588	180
727 158 589	180
727 158 590	180
727 158 591	180
727 158 592	180
727 158 594	180
727 158 595	180

Code	Page
727 200 105	45
727 200 106	45
727 200 107	45
727 200 108	45
727 200 109	45
727 200 110	45
727 200 111	45
727 200 112	45
727 200 113	45
727 200 114	45
727 200 206	51
727 200 207	51
727 200 208	51
727 200 209	51
727 208 251	183
727 208 252	183
727 208 253	183
727 208 254	183
727 208 255	183
727 208 257	183
727 208 258	183
727 208 259	183
727 208 260	183
727 208 261	183
727 208 262	183
727 208 263	183
727 208 264	183
727 208 271	183
727 208 272	183
727 208 273	183
727 208 274	183
727 208 288	183
727 208 289	183
727 208 291	183
727 208 301	58
727 208 302	58
727 208 303	58
727 208 304	58
727 208 305	58
727 208 307	58
727 208 308	58
727 208 309	58
727 208 310	58
727 208 311	58
727 208 312	58
727 208 313	58
727 208 314	58
727 208 321	58
727 208 322	58
727 208 323	58
727 208 324	58
727 208 338	58
727 208 339	58
727 208 341	58
727 208 351	58
727 208 352	58
727 208 353	58
727 208 354	58
727 208 355	58
727 208 357	58
727 208 358	58
727 208 359	58
727 208 360	58
727 208 361	58
727 208 362	58
727 208 363	58
727 208 364	58

CODE NUMBER

Code	Page
727 208 371	58
727 208 372	58
727 208 373	58
727 208 374	58
727 208 388	58
727 208 389	58
727 208 391	58
727 208 506	57
727 208 507	57
727 208 508	57
727 208 509	57
727 208 510	57
727 208 511	57
727 208 512	57
727 208 513	57
727 208 514	57
727 208 515	57
727 208 516	57
727 208 517	57
727 208 519	57
727 208 520	57
727 208 535	57
727 208 536	57
727 208 537	57
727 208 538	57
727 208 539	57
727 208 540	57
727 208 541	57
727 208 542	57
727 208 543	57
727 208 544	57
727 208 545	57
727 208 546	57
727 208 547	57
727 208 548	57
727 208 549	57
727 208 550	57
727 208 568	57
727 208 571	57
727 208 572	57
727 208 573	57
727 208 574	57
727 208 575	57
727 208 581	180
727 208 582	180
727 208 583	180
727 208 584	180
727 208 585	180
727 208 586	180
727 208 587	180
727 208 588	180
727 208 589	180
727 208 590	180
727 208 591	180
727 208 592	180
727 208 593	180
727 208 594	180
727 208 595	180
727 510 155	53
727 510 156	53
727 510 157	53
727 510 158	53
727 510 159	53
727 510 160	53
727 510 161	53
727 510 172	53
727 510 173	53

Code	Page
727 510 174	53
727 510 255	184
727 510 256	184
727 510 257	184
727 510 258	184
727 510 259	184
727 510 260	184
727 510 261	184
727 510 272	184
727 510 273	184
727 510 274	184
727 513 006	53
727 513 007	53
727 513 008	53
727 513 009	53
727 513 010	53
727 513 011	53
727 518 412	68
727 518 413	68
727 518 414	68
727 518 506	68
727 518 507	68
727 518 508	68
727 518 509	68
727 518 510	68
727 518 511	68
727 518 512	68
727 518 513	68
727 518 514	68
727 518 606	185
727 518 607	185
727 518 608	185
727 518 609	185
727 518 610	185
727 518 611	185
727 518 612	185
727 518 613	185
727 518 614	185
727 520 155	53
727 520 156	53
727 520 157	53
727 520 158	53
727 520 159	53
727 520 160	53
727 520 161	53
727 520 172	53
727 520 173	53
727 520 174	53
727 520 255	184
727 520 256	184
727 520 257	184
727 520 258	184
727 520 259	184
727 520 260	184
727 520 261	184
727 520 272	184
727 520 273	184
727 520 274	184
727 528 412	68
727 528 413	68
727 528 414	68
727 528 506	68
727 528 507	68
727 528 508	68
727 528 509	68
727 528 510	68
727 528 511	68

Code	Page
727 528 512	68
727 528 513	68
727 528 514	68
727 528 606	185
727 528 607	185
727 528 608	185
727 528 609	185
727 528 610	185
727 528 611	185
727 528 612	185
727 528 613	185
727 528 614	185
727 530 206	71
727 530 207	71
727 530 208	71
727 530 209	71
727 530 210	71
727 530 211	71
727 530 706	71
727 530 707	71
727 530 708	71
727 530 709	71
727 530 710	71
727 530 711	71
727 550 205	72
727 550 206	72
727 550 207	72
727 550 208	72
727 550 209	72
727 550 210	72
727 550 211	72
727 550 705	71
727 550 706	71
727 550 707	71
727 550 708	71
727 550 709	71
727 550 710	71
727 550 711	71
727 600 105	73
727 600 106	73
727 600 107	73
727 600 108	73
727 600 109	73
727 600 110	73
727 600 111	73
727 600 112	73
727 600 113	73
727 600 114	73
727 608 412	69
727 608 413	69
727 608 414	69
727 608 506	69
727 608 507	69
727 608 508	69
727 608 509	69
727 608 510	69
727 608 511	69
727 608 512	69
727 608 513	69
727 608 514	69
727 608 516	69
727 608 517	69
727 608 518	69
727 608 519	69
727 608 520	69
727 608 521	69
727 640 155	75

CODE NUMBER

Code	Page
727 640 156	75
727 640 157	75
727 640 158	75
727 640 159	75
727 640 160	75
727 640 161	75
727 640 172	75
727 640 173	75
727 640 174	75
727 648 506	70
727 648 507	70
727 648 508	70
727 648 509	70
727 648 510	70
727 648 511	70
727 648 512	70
727 648 513	70
727 648 514	70
727 690 405	77
727 690 406	77
727 690 407	77
727 690 408	77
727 690 409	77
727 690 410	77
727 690 411	77
727 690 422	77
727 690 423	77
727 690 424	77
727 700 021	211
727 700 206	210
727 700 207	210
727 700 208	210
727 700 209	210
727 700 210	210
727 700 211	210
727 700 212	210
727 700 213	211
727 700 214	211
727 700 215	211
727 700 216	211
727 700 217	211
727 700 219	211
727 700 220	211
727 700 221	211
727 700 222	211
727 700 223	211
727 700 224	211
727 700 225	211
727 700 313	210
727 700 314	210
727 700 315	210
727 700 316	210
727 700 317	210
727 700 318	210
727 700 319	210
727 700 320	210
727 700 321	210
727 700 322	210
727 700 323	210
727 700 324	210
727 700 325	210
727 700 406	202
727 700 407	202
727 700 408	202
727 700 409	202
727 700 410	202
727 700 411	202

Code	Page
727 700 412	202
727 700 413	203
727 700 414	203
727 700 416	203
727 700 417	203
727 700 419	203
727 700 420	203
727 700 421	203
727 700 422	203
727 700 423	203
727 700 513	202
727 700 514	202
727 700 515	202
727 700 516	202
727 700 517	202
727 700 518	202
727 700 519	202
727 700 520	202
727 700 521	202
727 700 522	202
727 700 523	202
727 701 206	212
727 701 207	212
727 701 208	212
727 701 209	212
727 701 210	212
727 701 211	212
727 701 212	212
727 701 213	212
727 701 214	212
727 701 217	212
727 701 220	212
727 701 406	204
727 701 407	204
727 701 408	204
727 701 409	204
727 701 410	204
727 701 411	204
727 701 412	204
727 701 413	205
727 701 414	205
727 701 422	205
727 701 423	205
727 701 513	204
727 701 514	204
727 701 521	204
727 701 522	204
727 701 523	204
727 730 106	213
727 730 107	213
727 730 108	213
727 730 109	213
727 730 110	213
727 730 111	213
727 740 106	151
727 740 107	151
727 740 108	151
727 740 109	151
727 740 110	151
727 740 111	151
727 790 206	47
727 790 207	47
727 790 208	47
727 790 209	47
727 790 210	47
727 790 211	47
727 790 212	47

Code	Page
727 790 213	47
727 790 214	47
727 790 257	47
727 790 258	47
727 790 259	47
727 790 260	47
727 790 263	47
727 798 412	64
727 798 413	64
727 798 414	64
727 798 506	62
727 798 507	62
727 798 508	62
727 798 509	62
727 798 510	62
727 798 511	62
727 798 512	62
727 798 513	62
727 798 514	62
727 798 515	62
727 798 516	62
727 798 517	62
727 798 519	62
727 798 520	62
727 798 535	63
727 798 536	63
727 798 540	63
727 798 541	63
727 798 542	63
727 798 543	63
727 798 544	63
727 798 545	63
727 798 546	63
727 798 547	63
727 798 548	63
727 798 549	63
727 798 550	63
727 798 568	62
727 798 571	62
727 798 572	62
727 798 573	62
727 798 574	62
727 798 575	62
727 798 581	181
727 798 582	181
727 798 583	181
727 798 584	181
727 798 585	181
727 798 586	181
727 798 587	181
727 798 588	181
727 798 589	181
727 798 590	181
727 798 591	181
727 798 592	181
727 798 593	181
727 798 594	181
727 798 595	181
727 798 657	63
727 798 658	63
727 798 659	63
727 798 660	63
727 798 663	63
727 798 812	64
727 798 813	64
727 798 814	64
727 798 816	64

CODE NUMBER

Code	Page
727 798 817	64
727 798 818	64
727 798 819	64
727 798 820	64
727 798 821	64
727 798 822	64
727 798 823	64
727 798 824	64
727 798 825	64
727 798 842	64
727 798 844	64
727 798 845	64
727 798 846	64
727 798 847	64
727 798 848	64
727 798 849	64
727 798 850	64
727 798 887	181
727 798 888	181
727 798 889	181
727 798 891	181
727 798 892	181
727 798 893	181
727 798 894	181
727 798 895	181
727 800 009	48
727 800 010	48
727 800 011	48
727 800 012	48
727 800 013	48
727 800 014	48
727 808 009	65
727 808 010	65
727 808 011	65
727 808 012	65
727 808 013	65
727 808 014	65
727 808 016	65
727 808 017	65
727 808 020	65
727 808 022	65
727 808 023	65
727 808 034	65
727 808 035	65
727 808 036	65
727 808 037	65
727 808 038	65
727 808 039	65
727 808 041	65
727 808 042	65
727 808 045	65
727 808 047	65
727 808 048	65
727 810 106	48
727 810 107	48
727 810 108	48
727 810 109	48
727 810 110	48
727 810 111	48
727 810 112	48
727 810 113	48
727 810 114	48
727 900 006	42
727 900 007	42
727 908 537	59
727 908 541	59
727 908 542	59

Code	Page
727 908 546	59
727 908 547	59
727 908 548	59
727 908 552	59
727 908 553	59
727 908 554	59
727 908 558	59
727 908 559	59
727 908 560	59
727 908 564	59
727 908 565	59
727 908 566	59
727 908 570	59
727 908 571	59
727 908 576	59
727 908 577	59
727 908 580	59
727 908 584	59
727 908 585	59
727 908 588	59
727 908 590	59
727 908 592	59
727 908 595	59
727 908 596	59
727 908 597	59
727 908 637	182
727 908 641	182
727 908 642	182
727 908 646	182
727 908 647	182
727 908 648	182
727 908 652	182
727 908 653	182
727 908 654	182
727 908 658	182
727 908 659	182
727 908 660	182
727 908 664	182
727 908 665	182
727 908 666	182
727 908 670	182
727 908 671	182
727 908 676	182
727 908 677	182
727 908 680	182
727 908 684	182
727 908 685	182
727 908 688	182
727 908 690	182
727 908 692	182
727 908 693	182
727 908 695	182
727 908 696	182
727 908 697	182
727 908 900	60
727 908 901	60
727 908 902	60
727 908 903	60
727 908 904	60
727 908 905	60
727 908 906	60
727 908 908	60
727 908 909	60
727 908 912	60
727 908 916	60
727 908 917	60
727 908 920	60

Code	Page
727 908 922	60
727 908 924	60
727 908 925	60
727 908 926	60
727 908 927	60
727 908 928	60
727 908 929	60
727 908 930	60
727 908 932	60
727 908 933	60
727 908 934	60
727 908 936	60
727 908 937	60
727 908 940	60
727 908 941	60
727 908 942	60
727 908 945	60
727 908 946	60
727 908 947	60
727 908 949	60
727 908 952	182
727 908 955	182
727 908 957	60
727 908 958	60
727 908 959	60
727 908 961	59
727 908 962	59
727 908 963	59
727 908 965	59
727 908 966	59
727 908 971	60
727 908 972	60
727 908 974	59
727 908 975	59
727 908 976	59
727 908 977	59
727 908 978	59
727 908 979	59
727 908 983	59
727 908 987	59
727 908 990	59
727 908 991	59
727 908 992	59
727 908 995	59
727 908 996	59
727 908 997	59
727 910 105	45
727 910 106	45
727 910 107	45
727 910 108	45
727 910 109	45
727 910 110	45
727 910 111	45
727 910 112	45
727 910 113	45
727 910 114	45
727 910 205	49
727 910 206	49
727 910 207	49
727 910 208	49
727 910 209	49
727 910 210	49
727 910 211	49
727 910 266	66
727 910 267	66
727 910 268	66
727 910 269	66

CODE NUMBER

Code	Page
727 910 270	66
727 910 271	66
727 910 334	46
727 910 337	46
727 910 338	46
727 910 341	46
727 910 342	46
727 910 346	46
727 910 347	46
727 910 348	46
727 910 352	46
727 910 353	46
727 910 354	46
727 910 355	46
727 910 358	46
727 910 359	46
727 910 360	46
727 910 361	46
727 910 364	46
727 910 370	46
727 910 371	46
727 910 376	46
727 910 433	51
727 910 434	51
727 910 437	51
727 910 441	51
727 910 446	51
727 910 452	51
727 910 505	49
727 910 506	49
727 910 507	49
727 910 508	49
727 910 509	49
727 910 510	49
727 910 511	49
727 910 556	66
727 910 557	66
727 910 558	66
727 910 559	66
727 910 560	66
727 910 561	66
727 910 906	45
727 910 907	45
727 910 908	45
727 910 909	45
727 910 910	45
727 910 911	45
727 910 912	45
727 910 913	45
727 910 914	45
727 913 006	49
727 913 007	49
727 913 008	49
727 913 009	49
727 913 010	49
727 913 011	49
727 913 013	49
727 913 014	49
727 914 266	50
727 914 267	50
727 914 268	50
727 914 269	50
727 914 270	50
727 914 271	50
727 914 356	66
727 914 357	66
727 914 358	66

Code	Page
727 914 359	66
727 914 360	66
727 914 361	66
727 914 555	50
727 914 556	50
727 914 557	50
727 914 558	50
727 914 559	50
727 914 560	50
727 914 561	50
727 914 656	67
727 914 657	67
727 914 658	67
727 914 659	67
727 914 660	67
727 914 661	67
727 960 105	46
727 960 106	46
727 960 107	46
727 960 108	46
727 960 109	46
727 960 110	46
727 960 111	46
727 960 112	46
727 960 113	46
727 960 114	46
727 960 406	52
727 960 407	52
727 960 408	52
727 960 409	52
727 960 410	52
727 960 411	52
727 968 606	67
727 968 607	67
727 968 608	67
727 968 609	67
727 968 610	67
727 968 611	67
727 968 910	61
727 968 911	61
727 968 912	61
727 968 913	61
727 968 914	61
727 968 915	61
727 968 916	61
727 968 917	61
727 968 918	61
727 968 919	61
727 968 920	61
727 968 921	61
727 968 922	61
727 968 923	61
727 968 924	61
727 968 925	61
727 968 931	61
727 968 932	61
727 968 933	61
727 968 934	61
727 968 935	61
727 968 936	61
727 968 937	61
727 968 938	61
727 968 939	61
727 968 940	61
727 968 941	61
727 968 942	61
727 968 943	61

Code	Page
727 968 944	61
727 968 945	61
727 968 946	61
727 968 947	61
727 968 948	61
727 968 949	61
727 968 950	61
727 968 981	183
727 968 982	183
727 968 983	183
727 968 984	183
727 968 985	183
727 968 986	183
727 968 987	183
727 968 988	183
727 968 989	183
727 968 990	183
727 968 991	183
727 968 992	183
727 968 993	183
727 968 994	183
727 968 995	183
728 018 412	163
728 018 413	163
728 018 414	163
728 108 506	163
728 108 507	163
728 108 508	163
728 108 509	163
728 108 510	163
728 108 511	163
728 158 412	164
728 158 413	164
728 158 414	164
728 158 506	164
728 158 507	164
728 158 508	164
728 158 509	164
728 158 510	164
728 158 511	164
728 208 412	165
728 208 413	165
728 208 414	165
728 208 506	165
728 208 507	165
728 208 508	165
728 208 509	165
728 208 510	165
728 208 511	165
728 518 526	172
728 518 527	172
728 518 528	172
728 518 529	172
728 518 530	172
728 518 531	172
728 528 526	172
728 528 527	172
728 528 528	172
728 528 529	172
728 528 530	172
728 528 531	172
728 598 006	169
728 598 008	169
728 598 009	169
728 598 010	169
728 598 014	169
728 598 016	169

CODE NUMBER

Code	Page
728 598 018	169
728 598 056	169
728 598 057	169
728 598 059	169
728 598 062	169
728 598 065	169
728 598 067	169
728 598 207	171
728 598 209	171
728 598 213	171
728 598 215	171
728 598 217	171
728 598 219	171
728 598 259	170
728 598 262	170
728 598 265	170
728 598 267	170
728 598 269	170
728 598 309	170
728 598 312	170
728 598 315	170
728 598 317	170
728 598 319	170
728 598 357	170
728 598 359	170
728 598 365	170
728 598 367	170
728 598 369	170
728 598 406	171
728 598 408	171
728 598 410	171
728 598 414	171
728 598 416	171
728 598 418	171
728 598 516	171
728 598 518	171
728 598 520	171
728 608 506	172
728 608 507	172
728 608 508	172
728 608 509	172
728 608 510	172
728 608 511	172
728 798 412	167
728 798 413	167
728 798 414	167
728 798 506	167
728 798 507	167
728 798 508	167
728 798 509	167
728 798 510	167
728 798 511	167
728 908 464	166
728 908 465	166
728 908 466	166
728 908 470	166
728 908 471	166
728 908 476	166
728 908 477	166
728 908 537	166
728 908 541	166
728 908 542	166
728 908 546	166
728 908 547	166
728 908 548	166
728 908 552	166
728 908 553	166

Code	Page
728 908 554	166
728 908 558	166
728 908 559	166
728 908 560	166
728 914 056	168
728 914 057	168
728 914 058	168
728 914 059	168
728 914 060	168
728 914 061	168
728 914 106	169
728 914 107	169
728 914 108	169
728 914 109	169
728 914 110	169
728 914 111	169
728 918 056	168
728 918 057	168
728 918 058	168
728 918 059	168
728 918 060	168
728 918 061	168
728 918 106	168
728 918 107	168
728 918 108	168
728 918 109	168
728 918 110	168
728 918 111	168
734 600 106	73
734 600 107	73
734 600 108	73
734 600 109	73
734 600 110	73
734 600 111	73
745 410 107	127
748 400 004	216
748 400 005	216
748 400 006	216
748 400 007	216
748 400 008	216
748 400 009	216
748 400 010	216
748 400 011	216
748 400 012	216
748 400 013	216
748 400 014	217
748 400 015	217
748 400 016	217
748 400 017	217
748 400 018	217
748 400 019	217
748 400 020	217
748 400 021	217
748 400 022	217
748 400 023	217
748 400 024	217
748 400 025	217
748 400 026	217
748 400 027	217
748 400 031	217
748 400 032	217
748 400 033	217
748 410 000	214
748 410 001	214
748 410 002	214
748 410 003	99
748 410 004	214

Code	Page
748 410 005	214
748 410 006	120
748 410 007	120
748 410 008	120
748 410 009	120
748 410 010	116
748 410 011	116
748 410 012	214
748 410 013	214
748 410 014	214
748 410 015	214
748 410 016	214
748 410 017	214
748 410 018	214
748 410 019	214
748 410 022	214
748 410 023	102
748 410 027	116
748 410 042	104
748 410 059	99
748 410 062	99
748 410 103	116
748 410 106	99
748 410 116	116
748 410 119	102
748 410 151	99
748 410 163	214
748 410 173	214
748 410 174	214
748 410 182	214
748 410 212	127
748 410 231	99
748 410 254	102
748 413 001	199
748 413 002	199
748 413 003	199
748 413 007	199
748 413 012	199
748 413 013	199
748 413 014	199
748 413 015	199
748 413 016	199
748 413 017	199
748 413 018	199
748 413 019	199
748 413 022	199
748 413 163	199
748 413 173	199
748 413 182	199
748 440 100	216
748 440 101	215
748 440 102	216
748 440 103	216
748 440 104	216
748 440 105	216
748 440 106	216
748 440 107	216
748 440 108	216
748 440 109	216
748 440 110	216
748 440 111	216
748 440 112	216
748 440 114	216
748 440 115	216
748 440 117	216
748 440 118	216
748 440 119	216

CODE NUMBER

Code	Page
748 440 120	216
748 440 302	215
748 440 303	215
748 440 304	215
748 440 305	215
748 440 306	215
748 440 307	215
748 440 308	215
748 440 309	215
748 440 310	215
748 440 311	215
748 440 312	215
748 440 313	215
748 440 314	215
748 440 315	215
748 440 316	215
748 440 317	215
748 440 318	215
748 440 319	215
748 440 320	215
748 441 302	199
748 441 303	199
748 441 304	199
748 441 305	199
748 441 306	199
748 441 307	199
748 441 308	199
748 441 309	199
748 441 310	199
748 441 311	199
748 441 312	199
748 441 313	199
748 441 314	199
748 441 315	199
749 400 005	216
749 400 006	216
749 400 007	216
749 400 008	216
749 400 009	216
749 400 010	216
749 400 011	216
749 400 012	216
749 400 013	216
749 400 015	217
749 400 016	217
749 400 017	217
749 400 018	217
749 400 019	217
749 400 020	217
749 400 021	217
749 400 022	217
749 400 023	217
749 400 024	217
749 400 025	217
749 400 026	217
749 400 027	217
749 401 315	200
749 401 316	200
749 401 317	200
749 401 318	200
749 401 319	200
749 401 320	200
749 401 321	200
749 401 322	200
749 401 323	200
749 401 324	200
749 401 325	200

Code	Page
749 401 326	200
749 401 327	200
749 410 000	214
749 410 001	214
749 410 002	214
749 410 003	99
749 410 004	214
749 410 005	214
749 410 006	120
749 410 007	120
749 410 008	120
749 410 009	120
749 410 010	116
749 410 011	116
749 410 012	214
749 410 013	214
749 410 014	214
749 410 015	214
749 410 016	214
749 410 017	214
749 410 018	214
749 410 019	214
749 410 022	214
749 410 023	102
749 410 027	116
749 410 042	104
749 410 059	99
749 410 062	99
749 410 103	116
749 410 106	99
749 410 116	116
749 410 119	102
749 410 151	99
749 410 163	214
749 410 173	214
749 410 174	214
749 410 182	214
749 410 231	99
749 410 254	102
749 413 001	199
749 413 002	199
749 413 003	199
749 413 007	199
749 413 012	199
749 413 013	199
749 413 014	199
749 413 015	199
749 413 016	199
749 413 017	199
749 413 018	199
749 413 019	199
749 413 022	199
749 413 163	199
749 413 173	199
749 413 182	199
749 440 100	216
749 440 101	215
749 440 102	216
749 440 103	216
749 440 104	216
749 440 105	216
749 440 106	216
749 440 107	216
749 440 108	216
749 440 109	216
749 440 110	216
749 440 111	216

Code	Page
749 440 112	216
749 440 114	216
749 440 115	216
749 440 117	216
749 440 118	216
749 440 119	216
749 440 120	216
749 440 302	215
749 440 303	215
749 440 304	215
749 440 305	215
749 440 306	215
749 440 307	215
749 440 308	215
749 440 309	215
749 440 310	215
749 440 311	215
749 440 312	215
749 440 313	215
749 440 314	215
749 440 315	215
749 440 316	215
749 440 317	215
749 440 318	215
749 440 319	215
749 440 320	215
749 441 302	199
749 441 303	199
749 441 304	199
749 441 305	199
749 441 306	199
749 441 307	199
749 441 308	199
749 441 309	199
749 441 310	199
749 441 311	199
749 441 312	199
749 441 313	199
749 441 315	199
749 441 316	199
749 441 317	199
749 441 318	199
749 441 319	199
749 441 320	199
753 608 606	120
753 608 607	120
753 608 608	120
753 608 609	120
753 608 610	120
753 608 611	120
753 608 616	120
753 608 617	120
753 608 618	120
753 608 619	120
753 608 620	120
753 608 621	120
790 103 031	226
790 103 033	226
790 130 001	227
790 130 002	227
790 131 005	224
790 133 009	225
799 298 023	223
799 350 015	228
799 350 019	228

GEORGE FISCHER SALES LIMITED (“George Fischer”) CONDITIONS OF SALE (FOR GOODS AND SERVICES)

GEORGE FISCHER SALES LIMITED (“George Fischer”) CONDITIONS OF SALE (FOR GOODS AND SERVICES)

1 INTERPRETATION

- 1.1 In these conditions of sale the following words will (unless the context otherwise requires) have the following meanings: “Conditions” means the conditions set out below and overleaf. “Contract” means any contract between George Fischer and the Customer for the sale of any Works. “Customer” means the company, firm, body or person purchasing the Works. “Customer’s Property” means any dies, tools, patterns, drawings, specifications, designs, packagings and any other equipment, goods, materials, instructions or information supplied by or on behalf of the Customer to George Fischer in connection with the Works. “Goods” means any goods agreed in the Contract to be provided by George Fischer to the Customer (including but not limited to the whole or any part or parts of them, any raw materials, finished or semi-finished materials, machinery, parts, spares, commodities and any materials, articles and commodities supplied in connection with the Services). “Services” means any services agreed in the Contract to be provided by George Fischer to the Customer (including but not limited to the whole or any part or parts of them). “Works” means the Goods and/or the Services (as appropriate).
- 1.2 Any reference in these Conditions to any statute or statutory provision will (unless the context otherwise requires) be construed as a reference to that statute or statutory provision as may be amended, consolidated, modified, extended, re-enacted or replaced from time to time.
- 1.3 The headings in these Conditions are for reference only and will not affect the interpretation of these Conditions.
- 1.4 In these Conditions the words “unless otherwise agreed in writing” will mean unless otherwise agreed in writing and signed by a director or commercial manager of George Fischer.
- 1.5 George Fischer reserves the right at any time to correct any clerical, typographical or other similar errors made by its employees.

2 QUOTATIONS

- 2.1 Any quotation (whether written or oral) is given on the basis that no contract will come into existence otherwise than in accordance with the provisions of clauses REF_Ref488760478 \r \h 3.5 and REF_Ref488760491 \r \h 3.6.
- 2.2 Unless otherwise agreed in writing any quotation is valid only for a period of 45 days from its date of issue provided that George Fischer has not previously withdrawn it by written or oral notice to the Customer.
- 2.3 Any quotation is based on the instructions and information provided by the Customer and George Fischer reserves the right to amend the quotation at any time to cover any increase in price which may arise as a result of additional or incomplete instructions or information.

3 APPLICATION OF TERMS

- 3.1 (Subject to clause REF_Ref515266224 \r \h 3.4) these Conditions are the only conditions on which George Fischer is prepared to deal with the Customer and they will apply to all Contracts to the exclusion of any other terms and conditions including but not limited to those which the Customer purports to apply.
- 3.2 No terms or conditions endorsed upon, delivered with, referred to or stipulated or contained in any purchase order or other similar document delivered or sent by the Customer to George Fischer will form part of the Contract.
- 3.3 Any reference overleaf to the Customer’s purchase order or other similar document will not be deemed to imply that any terms or conditions endorsed upon, delivered with, referred to or stipulated or contained in such purchase order or other similar document will have effect to the exclusion or amendment of these Conditions.
- 3.4 Any variation to these Conditions and any representation about the Works will only be effective if it is agreed in writing, contains a specific reference to these Conditions and is signed by a director or commercial manager of both parties.
- 3.5 Each purchase order for Works issued by the Customer will be deemed to be an offer by the Customer to purchase Works subject to these Conditions.
- 3.6 No purchase order placed by the Customer will be deemed to be accepted by George Fischer until a written acknowledgement of order is issued by George Fischer or (if earlier) George Fischer commences the Works or supplies the Works to the Customer.
- 3.7 The Customer must ensure that the content of its order and any applicable specification are complete and accurate.
- 3.8 Unless otherwise agreed in writing all drawings, illustrations, descriptions, specifications, technical data, advertising and other similar information issued by George Fischer or contained in George Fischer’s catalogues, brochures, trade literature, price lists or other similar published materials are issued or published only for the purpose of giving an approximate idea of the Works described in them and will not form part of the Contract.
- 3.9 Any purchase order which has been accepted by George Fischer in accordance with clause REF_Ref488760478 \r \h 3.5 and REF_Ref488760491 \r \h 3.6 may only be amended, cancelled, postponed or varied by the Customer with the prior written consent of George Fischer and on terms that the Customer will indemnify George Fischer in full against all losses (including but not limited to loss of profit), costs, damages, charges and expenses incurred (directly or indirectly) by George Fischer as a result of such amendment, cancellation, postponement or variation.

4 DELIVERY

- 4.1 Any times specified or agreed by George Fischer for the delivery of the Works are given in good faith but are an estimate only. If no time is specified or agreed by George Fischer delivery will take place within a reasonable time. Unless otherwise agreed in writing time for the delivery of the Works will not be of the essence of the Contract.
- 4.2 George Fischer will use its reasonable endeavours to deliver the Works within the times set out in clause 4.1 but George Fischer will not be liable for the consequences of any delay or failure to deliver if the duration of the delay is not substantial or if the delay or failure is due to any circumstances beyond George Fischer’s reasonable control or of an unexpected or exceptional nature.
- 4.3 (Subject to the provisions of clause REF_Ref488825221 \r \h 4.4) delivery will be deemed to take place when the Works are delivered to the Customer at such place as the parties may agree except that delivery to a carrier for the purpose of transmission to the Customer will be deemed to be delivery to the Customer and sections 32(2) and (3) of the Sale of Goods Act 1979 will not apply.
- 4.4 If George Fischer agrees to permit the Customer to collect the Works from George Fischer’s place of business then delivery will be deemed to take place when George Fischer notifies the Customer that the Works are ready for collection and unless otherwise agreed in writing the Customer will collect the Works within 3 working days of the issue of such notice.
- 4.5 George Fischer will use its reasonable endeavours to ensure where necessary that the Works will be packed so as to be adequately protected against damage in normal conditions of transit of usual duration. George Fischer will make such arrangements for the carriage and insurance of the Works as it agrees with the Customer.
- 4.6 George Fischer may deliver the Works in instalments. Deliveries of further instalments may be withheld until the Works comprised in earlier instalments have been paid for in full. Default by George Fischer (howsoever caused) in respect of one or more instalments will not entitle the Customer to terminate the relevant Contract as a whole.
- 4.7 In the event of any delay in the delivery of any Goods and/or the performance of any Services which are attributable to the Customer’s acts or omissions then:
(a) delivery of the Goods and/or performance of the Services will be deemed to have taken place at the time at which but for such delay or delays such delivery or performance would have taken place and any extra costs incurred as a result of such delay or delays will be added to the Contract price and will be payable by the Customer; and
(b) George Fischer may sell such Goods 28 days after such delay and deduct any monies payable to George Fischer by the Customer from the sale proceeds and account to the Customer for any excess or charge the Customer for any shortfall.
- 4.8 Where the Works are to be supplied from stock such supply is subject to the availability of the stock at the date of delivery.
- 4.9 On delivery to the Customer all Works should be examined. (Subject to clause 8.2) George Fischer will not be liable for any shortages in or non-delivery of the Works (even if caused by George Fischer’s negligence) unless the same is notified in writing by the Customer to George Fischer (together with all relevant details) within 14 days of the actual or anticipated date of delivery (as appropriate). Subject to such notice being provided George Fischer will, if it is reasonably satisfied that any Works have not been delivered as a result of George Fischer’s fault (in its sole discretion) either arrange for delivery as soon as reasonably possible or give credit (at the pro rata Contract price) to the Customer for such Works. Any shortages in or non-delivery of part of the Works will not affect the Contract in respect of the other parts of the Works.
- 4.10 If George Fischer complies with clause REF_Ref519060038 \r \h 4.9 it will (subject to clause REF_Ref515268830 \r \h 8.2) have no further liability (in contract, tort (including but not limited to negligence) or otherwise) for such shortages or non-delivery.

- 4.11 Whilst George Fischer will use reasonable endeavours to supply the exact quantity of the Works ordered by the Customer, George Fischer may supply and the Customer will accept up to 10% more or less than the exact quantity ordered. A pro rata charge or allowance at the Contract price will be made to cover any such variation.
- 4.12 The Customer (at its own expense) will ensure that the place where delivery of the Goods or performance of the Services is to take place is adequate and appropriate for such delivery or performance and will provide such access, equipment, facilities, protection, manual labour and information as may be required to enable George Fischer to perform its obligations under the Contract.

5 RISK AND OWNERSHIP

- 5.1 Unless otherwise agreed in writing the Works are at the risk of the Customer from the time of delivery or deemed delivery to the Customer (as appropriate) and loading and off loading (as appropriate) will be at the Customer’s risk. Section 20(2) of the Sale of Goods Act 1979 will not apply.
- 5.2 (Notwithstanding that risk in the Works will pass to the Customer in accordance with the provisions of clause REF_Ref488762748 \r \h 5.1) ownership of the Works (both legal and equitable) will only pass to the Customer (other than when ownership is properly vested in some other person by the operation of any statute) when George Fischer has received in full (in cash or cleared funds) all monies due to it from the Customer:
(a) in respect of the Works; and
(b) all other sums which are or which become due to George Fischer from the Customer on any account.
- 5.3 Until ownership of the Works has passed to the Customer under clause REF_Ref488762831 \r \h 5.2, the Customer will:
(a) hold the Works on a fiduciary basis as George Fischer’s bailee;
(b) keep the Works free from any charge, lien or other encumbrance;
(c) store the Works (at no cost to George Fischer) separately from all other materials of the Customer or any third party in such a way that they remain readily identifiable as George Fischer’s property;
(d) not destroy, deface or obscure any identifying mark on the Works or their packaging;
(e) maintain the Works in a satisfactory condition, insured on George Fischer’s behalf for their full price against all risks to the reasonable satisfaction of George Fischer and on request produce such policy of insurance to George Fischer;
(f) hold all proceeds of the insurance referred to in clause 5.3 REF_Ref515267181 \r \h (e) on trust for George Fischer and not mix it with any other money or pay the proceeds into any overdraft bank account; and
(g) not attach the Works to any real property without George Fischer’s consent.
- 5.4 The Customer may resell, use or otherwise dispose of the Works before ownership has passed to it only if any such sale, use or disposition will be effected in the ordinary course of the Customer’s business and will be a sale, use or disposition of George Fischer’s property on the Customer’s own behalf and the Customer will deal as principal.
- 5.5 George Fischer may while the owner of the Works (and without prejudice to any other rights it may have under or by virtue of these Conditions) demand the immediate return of the Works at any time and the Customer will forthwith comply with such demand and bear the expenses for such return.
- 5.6 The Customer grants to George Fischer (or its successors in title for the Works) and their respective employees and agents an irrevocable licence to enter at any time any premises where the Works are or may be situated for the purpose of inspecting or removing any such Works the ownership in which has remained with George Fischer. George Fischer will be entitled to recover payment for the Works notwithstanding that ownership of any of the Works has not passed from George Fischer.
- 5.8 The Works will be deemed sold or used in the order delivered to the Customer.

6 PRICE AND PAYMENT

- 6.1 The price stated in the Contract is based on the cost to George Fischer of materials, fuel, power, transport, taxes, duties, services, labour and all other costs at the date of George Fischer’s quotation, acknowledgement of order or supply (whichever is earlier). If at the date of delivery or deemed delivery of the Works there has been any increase in all or any of such costs, the price payable for the Works may be increased by George Fischer accordingly.
- 6.2 Quotations given in a currency other than sterling are based on the rate of exchange at the time of quoting and (unless otherwise agreed in writing between the parties) the price may be subject to revision if any different rate of exchange is ruling at the date of invoice.
- 6.3 (Unless otherwise agreed) the price for the Works is exclusive of any value added tax (and any other tax or duty relating to the manufacture, transportation, sale or delivery of the Works) and any costs or charges in relation to export and/or import, packaging, loading, unloading, carriage and insurance. Such costs and expenses will be paid by the Customer in addition to the price for the Works at the same time that it is due to pay for the Works.
- 6.4 Where George Fischer agrees (in its discretion) to bring forward the date of delivery of the Works at the Customer’s request any overtime or other additional costs reasonably incurred by George Fischer shall be charged to the Customer in addition to the Contract price.
- 6.5 George Fischer may invoice the Customer for the Works at any time after the delivery of the Works or the delivery of any instalment (as appropriate). If any delivery is postponed at the request or by the default of the Customer then George Fischer may submit its invoice at any time after the Works are ready for delivery or would have been ready in the ordinary course but for the request or default on the part of the Customer.
- 6.6 Customers who have been granted by George Fischer (in its sole discretion) a credit account facility will pay the price within 30 days of the end of the month in which the Works are despatched. George Fischer may (in its sole discretion) amend the terms of or withdraw such credit account facility at any time without notice with immediate effect and on such withdrawal all amounts due or accruing to George Fischer under the Contract will become immediately payable despite any other provision of these Conditions.
- 6.7 Customers who have not been granted a credit account facility will pay the price 5 working days prior to delivery of the Works.
- 6.8 No payment will be deemed to have been received until George Fischer has received cleared funds.
- 6.9 Time for payment will be of the essence of the Contract and the Customer will indemnify George Fischer against all expenses and legal costs incurred by George Fischer in recovering overdue amounts.
- 6.10 All payments payable to George Fischer under the Contract will become due immediately on termination of this Contract despite any other provision of these Conditions.
- 6.11 The Customer will make all payments due under the Contract without any deduction whether by way of set-off, counterclaim, discount, abatement or otherwise unless the Customer has a valid court order requiring an amount equal to such deduction to be paid by George Fischer to the Customer.
- 6.12 If the Customer fails to pay George Fischer any sum due pursuant to the Contract the Customer will be liable to pay interest to George Fischer on such sum from the due date for payment at an annual rate of 4% above the base lending rate of HSBC Bank plc from time to time accruing on a daily basis until payment is made in full (whether before or after any judgement). In the alternative, George Fischer in its absolute discretion, reserves the right to claim interest and compensation payments under the Late Payment of Commercial Debts (Interest) Act 1998.
- 6.13 Without prejudice to the provisions of clause REF_Ref515268302 \r \h 6.12 if the Customer fails or George Fischer reasonably believes that the Customer will fail to pay for the Work when due George Fischer may demand payment of all outstanding balances whether due or not, treat the Contract as repudiated by the Customer or suspend any future performance of the Contract or any other contract with the Customer until all overdue sums have been paid.

7 QUALITY

- 7.1 George Fischer warrants (subject to the provisions of this clause REF_Ref515268367 \r \h 7) that:
(a) on delivery of the Goods and for a period of 12 months from the date of delivery, the Goods will:
(i) be of satisfactory quality, within the meaning of the Sale of Goods Act 1979 (as amended); and
(ii) be reasonably fit for any particular purpose for which the Works are commonly supplied or are being bought (if the Customer has made known that purpose to George Fischer in writing and George Fischer has confirmed in writing that it is reasonable for the Customer to rely on the skill and judgement of George Fischer);
(b) and the Services will be performed with reasonable skill and care by properly qualified and experienced persons.

The above Terms of Business effective from 19th July 2006

GEORGE FISCHER SALES LIMITED ("George Fischer")

CONDITIONS OF SALE (FOR GOODS AND SERVICES) (Continued)

- 7.2 George Fischer will not be liable for any breach of any of the warranties in clause REF_Ref515268792 \r \h 7.1 unless:
- (a) the Customer gives written notice of the defect to George Fischer within 28 days of the date when the Customer discovers or ought reasonably to have discovered the defect;
 - (b) (if the defect is as a result of damage in transit) the Customer gives written notice of the defect to the carrier in the manner and within the appropriate time limit as set out in the carrier's terms of business; and George Fischer is given a reasonable opportunity after receiving such notice to examine such Works and the Customer (if requested to do so by George Fischer) returns such Works to George Fischer's place of business [at the Customer's cost] for the examination to take place there.
- 7.3 George Fischer will not be liable for a breach of any of the warranties in clause 7.1 where and to the extent that:
- (a) the defect arises from the Customer's Property or as a result of the Customer's negligence;
 - (b) the defect arises as a result of fair wear and tear, misuse, wilful damage, or abnormal working conditions;
 - (c) the defect arises as a result of any parts, materials or equipment not manufactured or workmanship not performed by George Fischer;
 - (d) the Customer makes any further use of such Works after giving written notice of the defect;
 - (e) the defect arises because the Customer has failed to follow George Fischer's instructions (whether oral or in writing) as to the storage, assembly, installation, commissioning, use, processing, handling or maintenance of the Works or (if there are none) good trade practice;
 - (f) the defect arises as a result of any installation, testing or commissioning of the Works performed by the Customer or any third party; or
 - (g) the defect arises as a result of any alteration, servicing or repair of the Works not made by George Fischer and without the written consent of George Fischer.
- 7.4 [Subject to clauses REF_Ref80676410 \r \h 7.2 and REF_Ref80676434 \r \h 7.3] if any of the Works do not conform with any of the warranties set out in clause REF_Ref515268792 \r \h 7.1 George Fischer will at its option and cost repair or replace such Goods [or the defective part], re-perform such Services or refund the price of such Works at the pro rata Contract rate.
- 7.5 If George Fischer complies with clause REF_Ref515268814 \r \h 7.4 it will [subject to clause REF_Ref515268830 \r \h 8.2] have no further liability (in contract, tort (including but not limited to negligence) or otherwise) for breach of any of the warranties in clause REF_Ref515268792 \r \h 7.1 in respect of such Works.
- 7.6 Any Goods replaced by George Fischer in accordance with the provisions of clause REF_Ref515268814 \r \h 7.4 will belong to George Fischer and any repaired or replacement Goods will be guaranteed on these terms for the unexpired portion of the original 12 month warranty period.
- ### 8 LIMITATION OF LIABILITY
- THE PRICES CHARGED FOR THE WORKS ARE BASED STRICTLY ON THE UNDERSTANDING OF ACCEPTANCE BY THE CUSTOMER OF THE PROVISIONS IN THE CONTRACT FOR THE LIMITATION OF GEORGE FISCHER'S LIABILITY. SHOULD THE CUSTOMER WISH GEORGE FISCHER TO ACCEPT ADDITIONAL LIABILITY THIS MAY BE DISCUSSED BETWEEN THE PARTIES AND THE PRICE MAY BE INCREASED ACCORDINGLY.
- 8.1 All warranties, conditions and other terms implied by statute or common law [except for the conditions implied by section 12 of the Sale of Goods Act 1979 and section 2 of the Supply of Goods and Services Act 1982] are, to the fullest extent permitted by law, excluded from the Contract.
- 8.2 Nothing in these Conditions excludes or limits the liability of George Fischer for fraudulent misrepresentation or for any death or personal injury caused by George Fischer's negligence or for any breach of the conditions implied by section 12 of the Sale of Goods Act 1979 and section 2 of the Supply of Goods and Services Act 1982.
- THE CUSTOMER'S ATTENTION IS IN PARTICULAR DRAWN TO THE PROVISIONS OF CLAUSES REF_Ref515268901 \r \h 8.3 AND REF_Ref515268903 \r \h 8.4
- 8.3 [Subject to clause REF_Ref515268930 \r \h 8.1 and REF_Ref515268830 \r \h 8.2] George Fischer will not be liable to the Customer in contract, tort (including but not limited to negligence), misrepresentation or otherwise for any:
- (a) economic loss of any kind (including but not limited to direct or indirect loss of profit, business, contracts, revenue or anticipated savings);
 - (b) damage to the Customer's reputation or goodwill;
 - (c) product recall costs; or
 - (d) any special, indirect or consequential loss or damage (even if George Fischer has been advised of such loss or damage) arising out of or in connection with the Contract.
- 8.4 [Subject to the provisions of clause REF_Ref515268830 \r \h 8.2 and REF_Ref515268901 \r \h 8.3] George Fischer's total liability in contract, tort (including but not limited to negligence), misrepresentation or otherwise arising out of or in connection with the Contract will be limited to the Contract price.
- ### 9 THE CUSTOMER'S PROPERTY
- 9.1 While George Fischer will take reasonable care of the Customer's Property whilst it is in George Fischer's possession, control or custody the Customer's Property will (unless otherwise agreed in writing) remain at the Customer's risk and all replacements and alterations of and repairs to the Customer's Property will be the Customer's responsibility.
- 9.2 George Fischer will not be liable for any loss or damage to the Customer's Property unless such loss or damage arises as a direct result of George Fischer's negligence. Where George Fischer is liable under this clause REF_Ref515269116 \r \h 9.2 George Fischer's liability to the Customer will be limited to the actual cost of the replacement or repair of the loss or damage to the Customer's Property.
- 9.3 The Customer will ensure that the Customer's Property is in good condition and suitable for use by George Fischer in the performance of the Contract and while George Fischer will use reasonable endeavours to verify any relevant aspects of the Customer's Property no responsibility is accepted by George Fischer for its accuracy.
- 9.4 Any defect in the Works which is due in whole or in part to the Customer's Property will not entitle the Customer to terminate the Contract, reject the Works, make any deductions from the Contract price or claim damages in respect of such defect.
- 9.5 The Customer will keep George Fischer indemnified in full against all liability, loss, damage, injury, claim, action, demand, expense or proceeding awarded against or incurred by George Fischer as a result of or in connection with the use by George Fischer of the Customer's Property unless such liability, loss, damage, injury, claim, action, demand, expense or proceeding is the result of George Fischer's negligent acts or omissions.
- ### 10 TOLERANCES AND TESTS
- 10.1 Unless otherwise agreed in writing gauges, weights, chemical composition and analysis, quantities and sizes will, so far as possible, be adhered to but reasonable excesses and deficiencies will be accepted by the Customer, who will not be entitled to reject any Works on the ground that they are not precisely as specified.
- 10.2 Unless otherwise agreed in writing, all tests, test pieces and inspections required by the Customer and agreed by George Fischer will be charged extra. All tests and inspections will take place under George Fischer's standard testing arrangements, and such tests will be final (except in the case of manifest error). All tests are subject to analytical tolerances.
- 10.3 The Customer may attend [at its own cost] all tests provided that it notifies George Fischer in writing of its intention to do so. The Customer will then be given not less than 5 working day's prior notice of the proposed date and time of any test and, if the Customer fails to attend, the test will proceed in its absence although it will be deemed to have been made in its presence.
- ### 11 OWNERSHIP OF TOOLING
- 11.1 Where patterns, dies, tools, drawings and equipment are not supplied by the Customer, only those which are specially made by George Fischer and separately charged to the Customer in full, will, when paid for by the Customer, become the property of the Customer.
- 11.2 George Fischer reserves the right to destroy or otherwise dispose of patterns, dies, tools, drawings and equipment in its possession, control or custody (whether or not the property of the Customer) from which the Customer has not required any Works to be made for a period of 12 months or more.
- ### 12 PACKING CASES AND PACKING MATERIALS
- 12.1 Unless otherwise agreed in writing packing cases and packing materials will not be charged extra but, where stated to be returnable, will be returned to George Fischer in good condition, within one month of receipt by the Customer. Where not returnable, the Customer will dispose of all packing in accordance with all regulations (whether statutory or otherwise) relating to the protection of the environment.
- ### 13 CONFIDENTIALITY
- 13.1 The Customer will keep confidential all technical data, commercial information, know how, specifications, inventions, processes, initiatives and other information which is of a confidential nature and which has been disclosed to the Customer by George Fischer and/or any member of the George Fischer group and/or its agents and any other confidential information concerning the business of George Fischer and/or any member of the George Fischer group or its products which the Customer may obtain ("Confidential Information").
- 13.2 The Customer will restrict disclosure of the Confidential Information to such of its employees, agents or subcontractors as need to know the same and will ensure that such employees, agents or subcontractors are subject to equivalent obligations of confidentiality as bind the Customer.
- 13.3 The Customer will not without the prior written consent of George Fischer publish or disclose the Confidential Information to any third party or make any use of the Confidential Information except to the extent necessary to implement the Contract.
- ### 14 INTELLECTUAL PROPERTY
- 14.1 The Customer will keep George Fischer indemnified in full against all liability, loss, damage, injury, claim, action, demand, expense or proceeding in respect of any infringement or alleged infringement of any patent, registered design, unregistered design, design copyright, trademark or other industrial or intellectual property rights resulting from any use by George Fischer of the Customer's Property or any compliance by George Fischer with the Customer's instructions, whether express or implied.
- 14.2 [Unless otherwise agreed in writing] ownership in all intellectual property rights subsisting in, resulting from or relating to the Works or any associated plans, descriptions, blue prints, designs, technical information, drawings, documents or specifications [except where these relate solely to the Customer's Property] will vest in or be assigned to George Fischer. If the Customer in any way acquires any such rights it will promptly inform George Fischer and take such steps as George Fischer may reasonably require to assign such rights or vest such title in George Fischer.
- 14.3 Nothing in these Conditions will be construed as any representation or warranty by George Fischer that the design, manufacture, use or sale of the Works is not an infringement of any third party intellectual property rights.
- ### 15 TERMINATION
- 15.1 George Fischer may terminate the Contract [and all other contracts between George Fischer and the Customer] immediately if:
- (a) the Customer fails to pay the price on the due date;
 - (b) the Customer is in breach of any term of the Contract and has failed to remedy such breach within 28 days of receipt of written notice specifying the breach and requiring it to be remedied;
 - (c) there is a material change in the ownership or control of the Customer; or
 - (d) the Customer is wound up or becomes insolvent or has a receiver or administrative receiver appointed or suffers the appointment or the presentation of a petition for the appointment of an administration or any equivalent or analogous event occurs in any relevant jurisdiction.
- 15.2 The termination of the Contract [howsoever arising] will be without prejudice to any rights and remedies which may have accrued to either party.
- 15.3 Any Conditions which impliedly have effect after termination or expiry will continue to be enforceable notwithstanding termination or expiry.
- ### 16 EXPORT SALES
- 16.1 Where the Works are supplied for export from the United Kingdom the provisions of this clause REF_Ref515269501 \r \h 16 will [subject to any special terms agreed in writing between the parties] apply despite any other provision of these Conditions.
- 16.2 The Uniform Laws on International Sales Act 1967 will not apply.
- 16.3 Unless otherwise agreed in writing the currency will be pounds sterling. The Customer will establish and maintain in favour of George Fischer an irrevocable and confirmed letter of credit in English with a UK clearing bank payable on drafts drawn at sight on presentation to the bank by George Fischer of a certified copy of George Fischer's invoice. All bank charges and other expenses in relation to the letter of credit will be borne by the Customer.
- 16.4 Unless otherwise agreed in writing Works will be sold C.I.F [as defined in INCOTERMS 2000 Edition].
- 16.5 The Customer will be responsible for complying with and shall comply with any legislation or regulation governing the export of the Works:
- (a) from the United Kingdom; and/or
 - (b) [where the Works are sourced from a country other than the United Kingdom] from such country and the importation of the Works into the country of destination and for payment of any relevant duties or taxes whether payable by the Customer or George Fischer.
- 16.6 Unless otherwise agreed in writing packing cases and packing materials will be charged extra but, where stated to be returnable, will be credited in full on return to George Fischer's place of business [carriage paid] in good condition, within one month of receipt by the Customer. Where not returnable, the Customer will dispose of all packing in accordance with all regulations (whether statutory or otherwise) relating to the protection of the environment.
- ### 17 LIEN
- George Fischer will have in respect of unpaid debts due to it from the Customer a general lien on all property of the Customer which is in George Fischer's possession for whatever reason and whether worked upon or not.
- ### 18 ASSIGNMENT AND SUBCONTRACTING
- 18.1 The Customer will not without the prior written consent of George Fischer assign or transfer the Contract or any part of it to any other person. George Fischer may without the prior written consent of the Customer assign, transfer or subcontract the Contract or any part of it to any other person.
- ### 19 GENERAL
- 19.1 Each right or remedy of George Fischer under these Conditions is without prejudice to any other right or remedy which George Fischer may have under these Conditions or otherwise.
- 19.2 Any notice or document shall be deemed served, if delivered by hand, at the time of delivery, if posted, 48 hours after posting and if sent by facsimile transmission, at the time of transmission. George Fischer may also send a notice or document by electronic communication in an e-mail address notified to George Fischer by the Customer. Such notice or document shall be deemed served if sent by e-mail transmission 48 hours after the time of transmission.
- 19.3 The illegality, invalidity or unenforceability of any provision of these Conditions will not affect the legality, validity or unenforceability of any other provisions of these Conditions.
- 19.4 Failure or delay by either party in exercising any right or remedy provided by the Contract or by law will not be construed as a waiver of such right or remedy or a waiver of any other right or remedy.
- 19.5 A person who is not a party to the Contract will have no right under the Contracts [Rights of Third Parties] Act 1999 to enforce any term of the Contract. This clause REF_Ref515269598 \r \h 19.5 does not affect any right or remedy of any person which exists or is available otherwise than pursuant to that Act.
- 19.6 The Customer agrees that it will have no remedy in respect of any untrue statement innocently or negligently made by or on behalf of George Fischer prior to the Contract upon which the Customer relied in entering into the Contract whether such statement was made orally or in writing unless the statement has been expressly agreed in writing by a director of George Fischer and/or the statement has been expressly incorporated in writing into the Contract.
- 19.7 George Fischer shall not be in breach of these Conditions or otherwise liable to the Customer by reason of any delay in performance or non-performance of any of its obligations due to any circumstances outside George Fischer's reasonable control.
- 19.8 The Contract will be governed by English law and the parties submit to the non-exclusive jurisdiction of the English courts.

GF Piping Systems > worldwide at home

www.georgfischer.co.uk

Our sales companies and representatives ensure local customer support in over 100 countries.

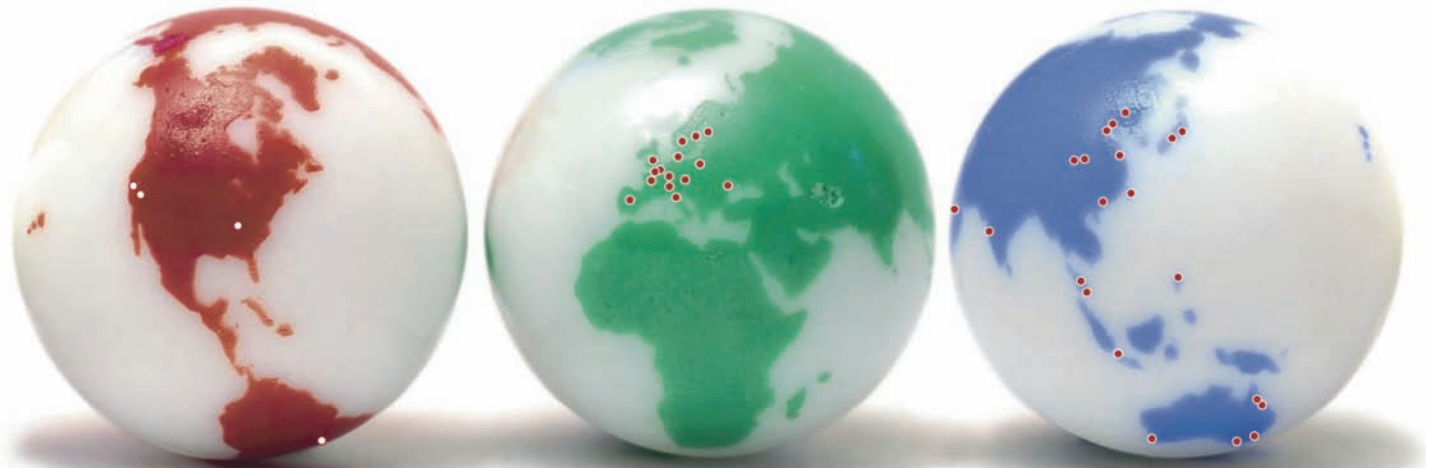

Australia
George Fischer Pty Ltd
Kingsgrove NSW 2008
Phone +61(0)2/95 54 39 77
australia.ps@georgfischer.com
www.georgfischer.com.au

Austria
Georg Fischer
Rohrleitungssysteme GmbH
3130 Herzogenburg
Phone +43(0)2782/856 43-0
austria.ps@georgfischer.com
www.georgfischer.at

Belgium/Luxembourg
Georg Fischer NV/SA
1070 Bruxelles/Brüssel
Phone +32(0)2/556 40 20
be.ps@georgfischer.com
www.georgfischer.be

Brazil
George Fischer Ltda
04795-100 São Paulo
Phone +55(0)11/5687 1311
br.ps@georgfischer.com

China
Georg Fischer
Piping Systems Ltd Shanghai
Pudong, Shanghai 201319
Phone +86(0)21/58 13 33 33
china.ps@georgfischer.com
www.cn.piping.georgfischer.com

Denmark/Iceland
Georg Fischer A/S
2630 Taastrup
Phone +45 (0)70 22 19 75
info.dk.ps@georgfischer.com
www.georgfischer.dk

France
George Fischer S.A.S.
93208 Saint-Denis Cedex 1
Phone +33(0)1/492 21 34 1
fr.ps@georgfischer.com
www.georgfischer.fr

Germany
Georg Fischer GmbH
73095 Albershausen
Phone +49(0)7161/302-0
info.de.ps@georgfischer.com
www.vgd.georgfischer.de

Georg Fischer DEKA GmbH
35232 Dautphetal-Mornshausen
Phone +49(0)6468/915-0
deka.ps@georgfischer.com
www.dekapipe.de

India
George Fischer Piping Systems Ltd
400 093 Mumbai
Phone +91(0)22/2820 2362
in.ps@georgfischer.com

Italy
Georg Fischer S.p.A.
20063 Cernusco S/N (MI)
Phone +3902/921 861
it.ps@georgfischer.com
www.georgfischer.it

Japan
Georg Fischer Ltd
556-0011 Osaka,
Phone +81(0)6/6635 2691
jp.ps@georgfischer.com
www.georgfischer.jp

Malaysia
George Fischer (M) Sdn. Bhd.
47500 Subang Jaya
Phone +60 (0)3-8024 7879
conne.kong@georgfischer.com.my

Middle East
George Fischer Piping Systems
Dubai, United Arab Emirates
Phone +971 4 289 41 20
gfdubai@emirates.net.ae
www.piping.georgfischer.com

Netherlands
Georg Fischer N.V.
8161 PA Epe
Phone +31(0)578/678 222
nl.ps@georgfischer.com
www.georgfischer.nl

Norway
Georg Fischer AS
1351 Rud
Phone +47(0)67 18 29 00
no.ps@georgfischer.com
www.georgfischer.no

Poland
Georg Fischer Sp. z o.o.
02-226 Warszawa
Phone +48(0)22/313 10 50
poland.ps@georgfischer.com
www.georgfischer.pl

Romania
Georg Fischer
Rohrleitungssysteme AG
70000 Bucharest - Sector 1
Phone +40(0)1/222 91 36
ro.ps@georgfischer.com

Singapore
George Fischer Pte Ltd
528 872 Singapore
Phone +65(0)67 47 06 11
sgp.ps@georgfischer.com
www.georgfischer.com.sg

Spain/Portugal
Georg Fischer S.A.
28046 Madrid
Phone +34(0)91/781 98 90
es.ps@georgfischer.com
www.georgfischer.es

Sweden/Finland
Georg Fischer AB
12523 Älvsjö-Stockholm
Phone +46(0)8/506 775 00
info.se.ps@georgfischer.com
www.georgfischer.se

Switzerland
Georg Fischer
Rohrleitungssysteme (Schweiz) AG
8201 Schaffhausen
Phone +41(0)52 631 30 26
ch.ps@georgfischer.com
www.piping.georgfischer.ch

Taiwan
Georg Fischer Ltd.
2F, No. 88, Hsing Te Road
San Chung City
Taipei Hsien, Taiwan (R.O.C.)
Phone +886 2 8512 2822
Fax +886 2 8512 2823

United Kingdom/Ireland
George Fischer Sales Limited
Coventry, CV2 2ST
Phone +44(0)2476 535 535
uk.ps@georgfischer.com
www.georgfischer.co.uk

USA/Canada/Latin America/Caribbean
George Fischer Inc.
Tustin, CA 92780-7258
Phone +1(714) 731 88 00
Toll Free 800/854 40 90
us.ps@georgfischer.com
www.us.piping.georgfischer.com

Export
Georg Fischer
Rohrleitungssysteme (Schweiz) AG
8201 Schaffhausen
Phone +41(0)52 631 11 11
export.ps@georgfischer.com
www.piping.georgfischer.com