

MASS SPECTROMETERS FOR  
CATALYSIS & THERMAL ANALYSIS



**HIDEN**  
ANALYTICAL

# MASS SPECTROMETERS

## for Catalysis and Thermal Applications

Hiden Analytical have been designing and developing the highest quality quadrupole mass spectrometer based gas analysis systems for over 25 years. We have built a reputation for delivering instruments with superior sensitivity, accuracy and reproducibility together with a first class global service and applications support network. From dedicated triple filter UHV TPD quadrupoles to fully integrated catalysis microreactor and mass spectrometer systems, Hiden have developed a range of analytical mass spectrometers that address the most advanced and demanding applications.



# CATLAB

## Automated Microreactor/MS System



CATLAB Microreactor Module

The Hiden CATLAB is a bench-top microreactor and combined mass spectrometer system for rapid and reproducible catalyst characterisation and reaction studies. The microreactor and mass spectrometer are delivered as a complete system from a single manufacturer, unique to the industry, ensuring optimum analysis via seamless hardware and software integration. The modular design further allows both instruments to operate as stand-alone components so that they may be interfaced with existing laboratory equipment such as TGAs or TCDs.

The Hiden CATLAB delivers a range of completely automated, dynamic, temperature programmed, pulse chemisorption and isothermal techniques. Recipe driven CATLAB software provides automatic control of gas composition and delivery, temperature ramp and set-point as well as full mass spectrometer parameter controls - a true first for the catalyst researcher. The standard system has 0-200 amu capability with options extending this to 1000 amu.

### APPLICATIONS:

temperature programmed desorption (TPD)

temperature programmed reduction/oxidation (TPR/O)

temperature programmed reaction (TPRx)

pulse chemisorption

pulse calibration

dispersion measurements

adsorption isotherms

reaction studies

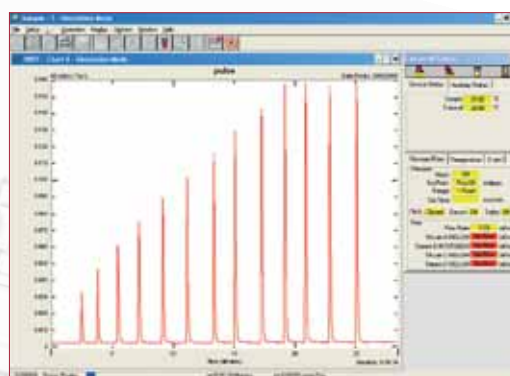

Pulse Adsorption Profile

# QIC SERIES

## Evolved Gas Analysers

The Hiden *QIC* Series Evolved Gas Analysers are a range of real time bench-top mass spectrometers for monitoring evolved gases and vapours across the pressure range 100 mbar to 2 bar. Mass range options are 200 amu, 300 amu, 510 amu and 1000 amu with an ultimate detection limit of 5 ppb.

They are offered with a wide range of interfaces for connection to thermal analysis equipment such as TGAs or tube furnaces and all components are designed to be user serviceable.

Each analyser is configured with Hiden's heated Quartz Inert Capillary (*QIC*) inlet for continuous sampling of permanent gases and vapours with a response time of less than 300 ms.

Independent bypass pumping allows the inlet flow rate to be chosen over the range 1 sccm to 20 sccm for matching to specific outlets. This unique design virtually eliminates the incidence of blockages compared with other inlet types. The fast response and recovery of the *QIC* inlet to vapour species far exceeds conventional capillary inlets making these analysers ideal for TPD, TPR/O and TPRx studies as well as continuous monitoring of reaction processes.



QIC-20



MID Trace



HPR-20 QICplus

[www.HidenAnalytical.com](http://www.HidenAnalytical.com)

#### FEATURES/OPTIONS:

- quantitative data output**
- simultaneous detection of more than 100 species from internal library**
- soft ionisation mode for reducing fragmentation**
- TPD/R/O analysis routines**
- analogue inputs for logging external signals, e.g. temperature and pressure**
- I/O subsystem enables synchronisation of data acquisition with external events**
- control of external devices such as MFCs for gas delivery and/or calibration**
- heated inlet particulate filter**
- multiport gas sampling valves**

# SPACI-MS

## Spatially Resolved Capillary Inlet MS

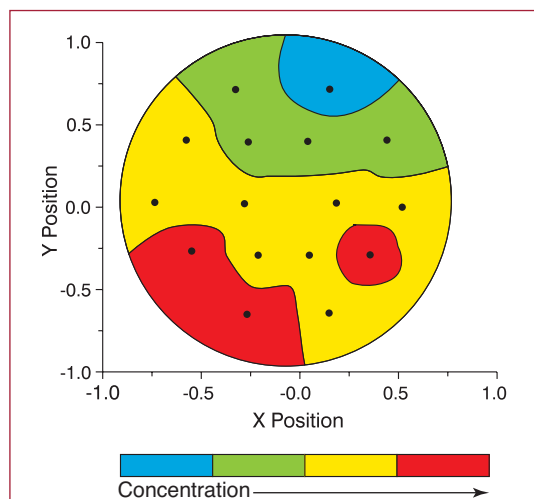

2D Concentration Plot

The Hiden Analytical spatially resolved capillary inlet MS (Spaci-MS) is the first commercially available instrument of its kind. The Spaci-MS inlet was originally conceived and developed by researchers at the Oak Ridge National Laboratory and Cummins, Inc. to study diesel catalysis <sup>(1)</sup> and has been further developed for a whole range of applications.

Spaci-MS allows both radial and axial species determination and temperature profiles, with high spatial and temporal resolution and with negligible interference in flow or temperature. The 16 channel multi-inlet is coupled to Hiden's fast transient MS to provide automatic and rapid mapping of temperature and species distributions.

The 16 capillary sampling probes and thermocouples are arranged in an X-Y array. A Z-shift provides movement and accurate positioning of the array in the Z plane. In usual practice, the 16 capillary sampling probes are sequentially analysed by the MS. The Z-shift is then actuated to move the sampling probe array to the next incremental Z position and the analysis sequence is repeated. On completion the analytical data provides a spatial representation of temperature and sample gas composition of the volume enclosed within the X-Y array over the total incremental Z distance moved.

### FEATURES:

**quantifies intra-catalyst-channel species transients and distributions**

**high temporal resolution**

**minimally invasive**

### APPLICATIONS:

**fuel cell studies**

**diesel engine catalysts**

**air exhaust mixing systems**

**non-thermal plasma reactors**

Ref: 1 Partridge, W.P. *et al.*  
Journal of Fuels & Lubricants, 2000, **109**, 2992-2999

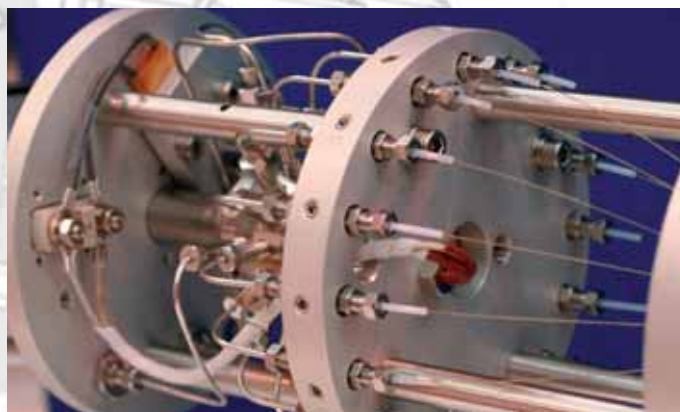

SPACI-MS Inlet

# TRANSIENT MS

## for Fast Event Studies

Hiden's transient MS is designed specifically for fast transient gas analysis making it ideal for analysis techniques such as SSITKA (Steady State Isotopic Transient Kinetic Analysis) where a very fast response is desired. Based on the HPR-20 QIC the system features a 1 m fast response capillary inlet (<150 msec response time) coupled directly to Hiden's pulse ion counting digital MS which is capable of measurement speeds of up to 500 data points/sec over the entire 7 decade dynamic range.

Data acquisition is triggered and synchronised by the gas pulse signal via the on-board and comprehensive range of I/O facilities of the MS.

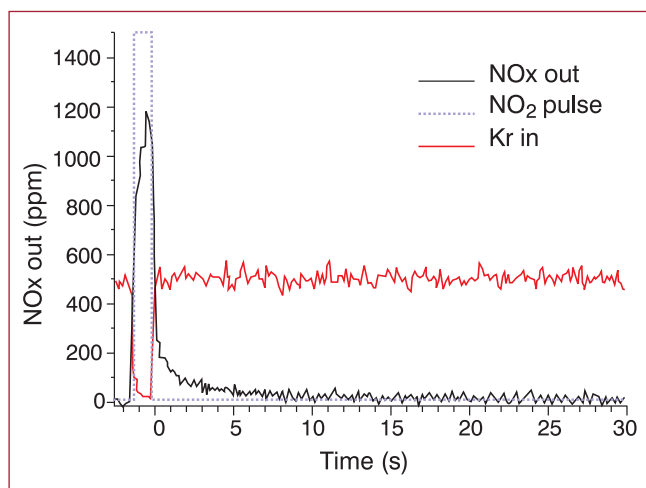

Diffusion of an  $\text{NO}_2$  Pulse through  $\text{Ba}/\gamma\text{Al}_2\text{O}_3$  <sup>(2)</sup>

#### FEATURES:

**fast response inlet <150 ms**

**fast data acquisition,  
500 data points/sec**

**wide dynamic range, 7 decade  
continuous log scale**

**synchronised data acquisition  
via TTL inputs**

Ref: 2 J.P. Breen, C. Rioche, R. Burch, C. Hardacre, F.C. Meunier  
Applied Catalysis B: Environmental, 2006, 72, 176-186  
© Elsevier

# TGA-MS

## Mass Spectrometer Inlets

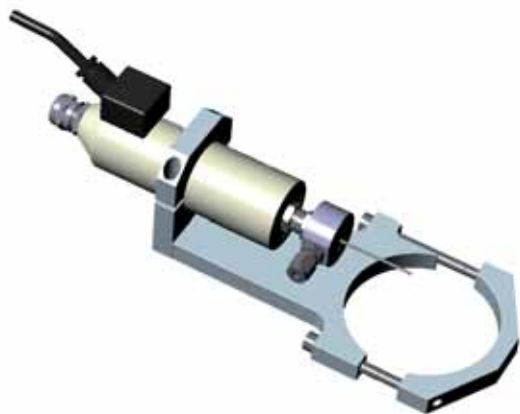

All of Hiden's capillary inlet gas analysers may additionally be equipped with fast response, low dead volume interfaces for the most popular TGA equipment.

Each interface has been custom engineered in collaboration with TGA manufacturers and includes, where necessary, robust clamping arrangements and in-line heated filter assembly between the outlet of the TGA and the MS capillary inlet.

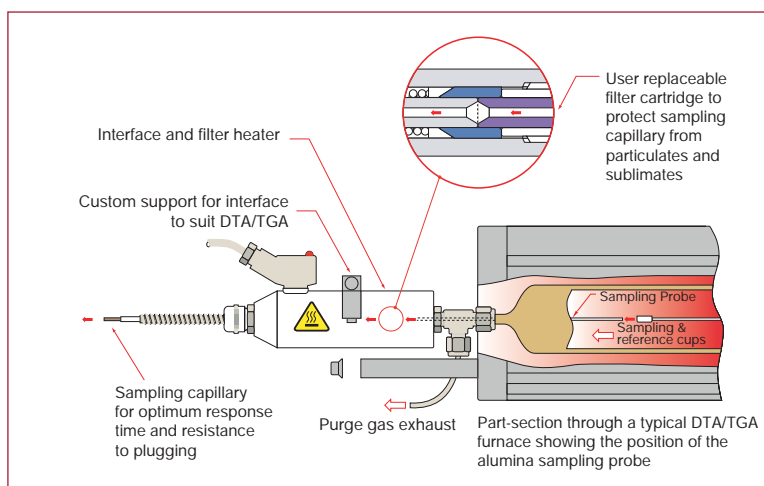

Typical TGA Inlet

### FEATURES:

**minimum dead volume**

**controllably heated sample inlet - no cold spots**

**inert materials**

**high performance gas handling for operation with low molecular weight gas components ( $H_2$ , He) and for flow matching with the TGA**

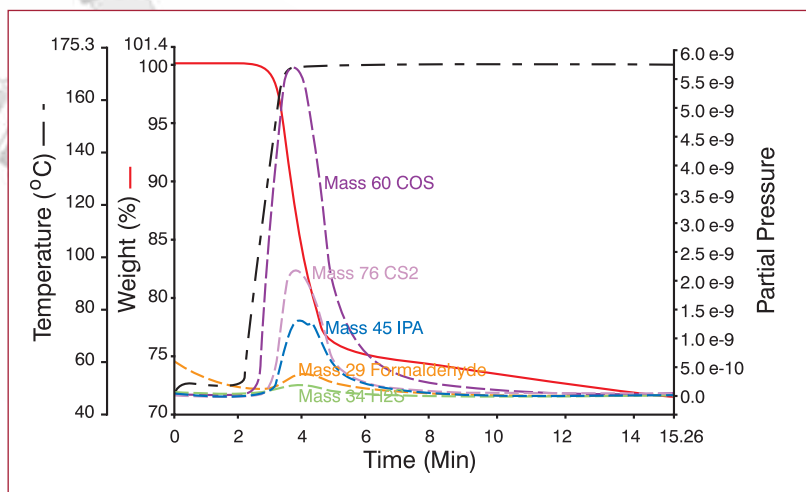

TGA-MS Plot

# UHV TPD

## for Fast Event UHV Studies

Hiden's 3F PIC Series Quadrupoles are high precision triple filter analysers with digital detectors for ultimate sensitivity and time resolution in UHV TPD applications.

3F Series analysers include a UHV compatible mass filter shroud and low profile ion source for close positioning to the desorption surface.

Both analogue and digital inputs are provided for synchronous acquisition start and sample temperature data display alongside mass channel data.

Multiple ion detection mode allows more than 100 channels to be monitored simultaneously, each with a unique set of MS parameters. Choose species from the internal library or via NIST MS database with direct import/export to MASsoft Professional.



3F PIC

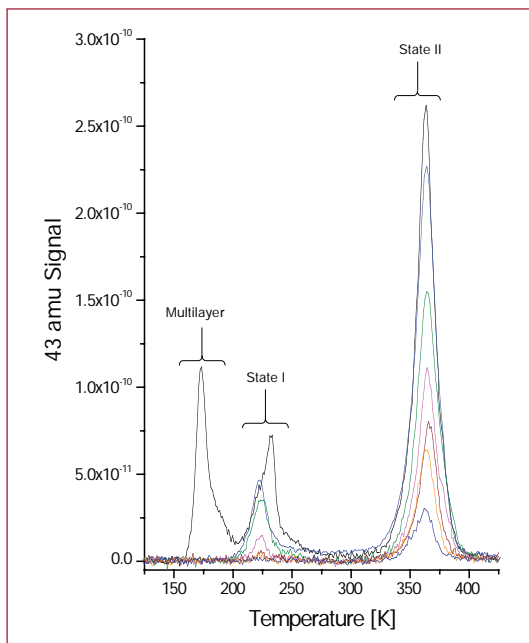

TPD Plot courtesy of M. Kadodwala (University of Glasgow, UK)

### FEATURES:

**low profile ion source**

**fast data acquisition**

**500 data points per second**

**wide dynamic range**

**7 decade continuous log scale**

**gating input for pulsed gas studies down to 100 nsec gating resolution**



# HPR-60 SKIMMER INLET MS

## Molecular Beam Inlet

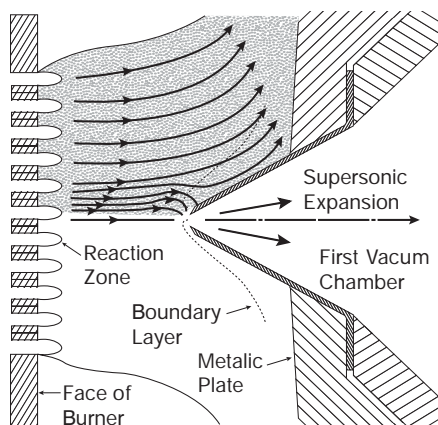

HPR-60 Schematic

The Hiden HPR-60 molecular beam mass spectrometer is a compact skimmer inlet MS for the analysis of reactive gas phase intermediates. Radicals are sampled via a multistage differentially pumped skimmer inlet and transferred to the MS ion source with minimal interaction with other species and without wall collisions. Customisable inlets allow connection to many different reactor systems.

The skimmer system, combined with a Hiden triple filter precision mass spectrometer, offers a sampling system with ultra fast response and high accuracy.

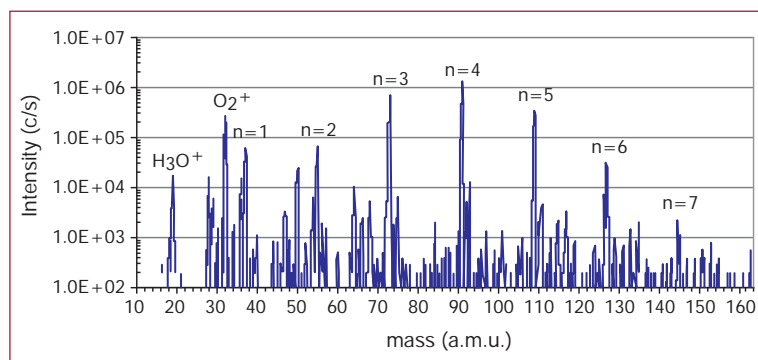

Hydrated Cluster Ions from Atmospheric Dielectric Barrier Discharge

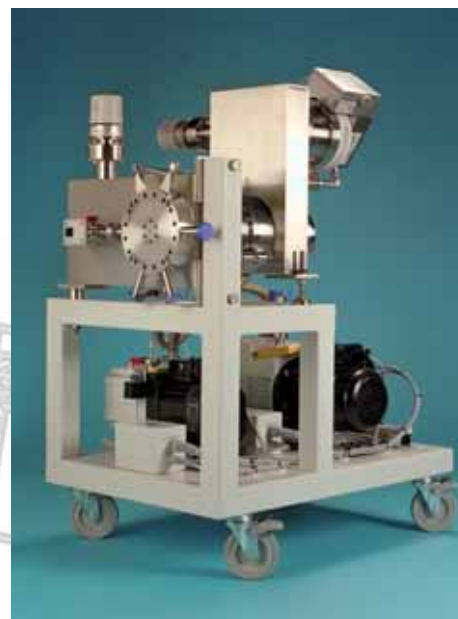

HPR-60

APPLICATIONS INCLUDE:

- catalytic reactors
- reaction kinetics
- study of transients
- plasma chemistry

# MASsoft PROFESSIONAL

## Control Software

All Hiden instruments are supplied with MASsoft Professional mass spectrometer control software. MASsoft Professional is a multilevel software package allowing both simple control of mass spectrometer parameters and complex manipulation of data and control of external devices.

Quick start tabs with user configurable single key start functions means novice users can start collecting data within seconds.

Scan templates allow fast set up of scans from previous similar experiments.

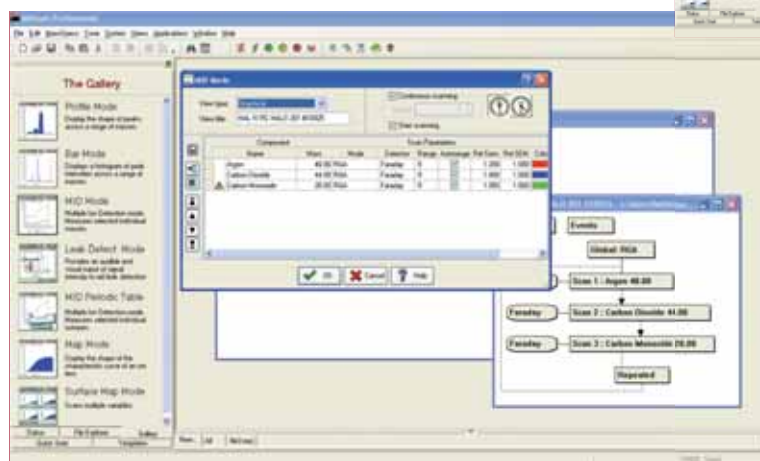
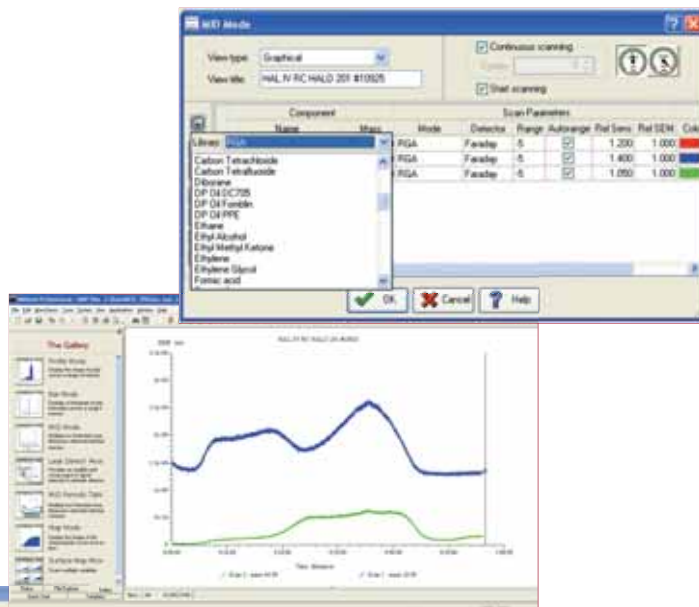

### FEATURES:

full control of the mass spectrometer ion source enables soft ionisation of complex organics, and appearance potential mass spectrometry for simplification of complex spectra

export data to NIST mass spectral database for comprehensive analysis of unknowns

export to external data analysis software, e.g. Excel, Origin or Hiden's TPD Analysis Software

control of external devices, e.g. mass flow controllers, gas switching/sampling valves and furnace temperature controllers

output data as percentage or ppm files

real time subtraction of overlapping peaks for quantitative measurements

# HIDEN APPLICATIONS

Hidden's quadrupole mass spectrometer systems address a broad application range in:



## Gas Analysis

- dynamic measurement of reaction gas streams
- molecular beam studies
- dissolved species probes



## Surface Science

- UHV TPD
- SIMS
- end point detection in ion beam etch
- elemental imaging - surface mapping



## Plasma Diagnostics

- plasma source characterisation
- etch and deposition process reaction kinetic studies
- analysis of neutral and radical species



## Vacuum Analysis

- partial pressure measurement and control of process gases
- reactive sputter process control
- vacuum diagnostics
- vacuum coating process monitoring



quadrupoles for advanced science



Hiden Analytical Ltd.  
420 Europa Boulevard  
Warrington  
WA5 7UN  
England

Tel: +44(0)1925 445225  
Fax: +44(0)1925 416518  
Email: [info@hiden.co.uk](mailto:info@hiden.co.uk)  
Web: [www.HidenAnalytical.com](http://www.HidenAnalytical.com)