



Standard Stock Range





United Alloys have an extensive inventory of aluminium, stainless steel, copper, brass and bronze in all semi-finished forms. It covers a wide range of grades/alloys, shapes and sizes - both industry standards and special or bespoke items for particular applications or individual customers.

We provide customers with a cost-effective single source for all their metals requirements, together with a comprehensive processing service which includes polishing, coating, blanking and 'cut to length'

No order is too large or too small and we offer a responsive and competitive service for supplying anything from single item orders to major JIT contracts, tailoring this service to the individual needs of every customer from small local businesses to major multinational corporations.

Whatever your requirement, in whatever quantity, United Alloys is ready and willing to satisfy your needs.

If you don't see what you want within these pages, give us a call - our range is continually expanding!

ISSUE 1a November 2011

Disclaimer

The information contained herein is based on our present knowledge and experience and is given in good faith. However no liability will be accepted by the Company in respect of any action taken by any third party in reliance thereon.

As the products used herein may be used for a wide variety of purposes and as the Company has no control over their use, the Company specifically excludes all conditions and warranties expressed or implied by statute or otherwise as to dimensions, properties and/or their fitness for any particular purpose. Any advice given by the Company to any third party is given for that party's assistance only and without any liability on the part of the Company.

Any contract between the Company and a customer will be subject to the Company's Conditions of Sale. The extent of the Company's liabilities to any customer is clearly set out in these Conditions; a copy of which is available on request.

Weights

All weights shown in this publication are for guidance only. They are calculated using nominal dimensions and scientifically recognised densities. Please note that in practice, the actual weight can vary significantly from theoretical weight due to variations in manufacturing tolerances and compositions.

United Alloys is a division of Aalco Metals Ltd

Aluminium

Aluminium	
Shate.....	4
Plate.....	4
Sheet.....	5
Painted Sheet.....	7
Stucco Sheet.....	7
Treadplate.....	7
Round Bar.....	8
Flat Bar.....	10
Square Bar.....	11
Equal Angle.....	12
Unequal Angle.....	13
Channel.....	14
Tee Section.....	14
Round Tube.....	15
Scaffold Tube.....	16
Box Section - Rectangular.....	17
Box Section - Square.....	17
Mouldings.....	18

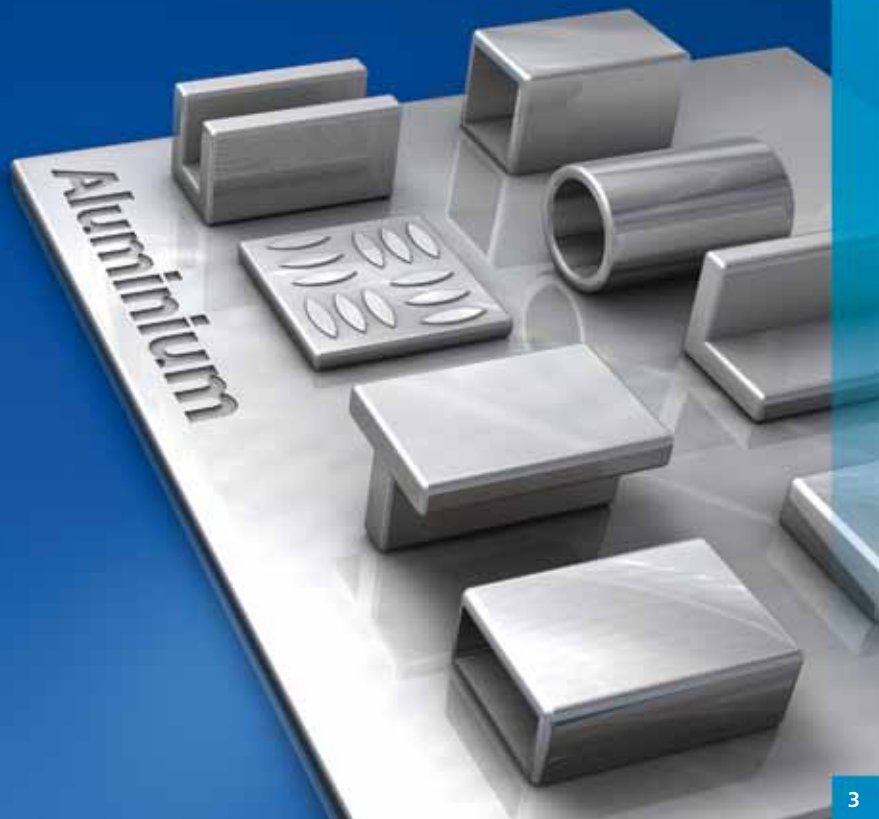

Aluminium Shate

Aluminium Shate Alloy 1050A H14

Size	KG/Sheet
2500mm X 1250mm X 4.0mm	34.21
2500mm X 1250mm X 5.0mm	42.77
2500mm X 1250mm X 6.0mm	51.32
2000mm X 1000mm X 6.0mm	32.85

Aluminium Shate Alloy 5083 O/H111

Size	KG/Sheet
2500mm X 1250mm X 4.0mm	33.71
2500mm X 1250mm X 5.0mm	42.14
2500mm X 1250mm X 6.0mm	50.56
2500mm X 1250mm X 8.0mm	67.42

Aluminium Shate Alloy 5251 H22

Size	KG/Sheet
2000mm X 1000mm X 4.0mm	21.7
2500mm X 1250mm X 4.0mm	34.0
3000mm X 1500mm X 4.0mm	48.9
2000mm X 1000mm X 5.0mm	27.2
2500mm X 1250mm X 5.0mm	42.5
3000mm X 1500mm X 5.0mm	61.1
2000mm X 1000mm X 6.0mm	32.6
2500mm X 1250mm X 6.0mm	50.9
3000mm X 1500mm X 6.0mm	73.4



Aluminium Shate Alloy 6082 T6/T651

Size	KG/Sheet
2500mm X 1250mm X 4.0mm	34.09
2500mm X 1250mm X 5.0mm	42.61
2500mm X 1250mm X 6.0mm	51.13
2500mm X 1250mm X 8.0mm	68.18

Aluminium Shate Alloy 5454

Size/Temper	KG/Sheet	
3048mm X 2032mm X 4.76mm (10ft X 6ft 8in)	0	80
3600mm X 2000mm X 4.76mm	H34	93
2515mm X 1829mm X 6mm (8ft 3in X 6ft)	H111	71
2595mm X 1874mm X 6mm	H24	79
2489mm X 1524mm X 6.2mm (8ft 2in X 5ft)	H22	64
2489mm X 1524mm X 6.2mm (8ft 2in X 5ft)	H34	64

Plate



Aluminium Plate Alloy 5083 O/H111

Size	KG/Plate
2500mm X 1250mm X 10.0mm	85
2500mm X 1250mm X 12.0mm	102
2500mm X 1250mm X 15.0mm	127
2500mm X 1250mm X 20.0mm	170
2500mm X 1250mm X 25.0mm	212

Aluminium Plate Alloy 6082 T651

Size	KG/Plate
2500mm X 1250mm X 10.0mm	85
2500mm X 1250mm X 12.0mm	102

Aluminium Sheet

Aluminium Sheet Alloy 1050A H14/H24



Size	KG/Sheet
2000mm X 1000mm X 0.5mm	2.74
2500mm X 1250mm X 0.5mm	4.28
2000mm X 1000mm X 0.6mm	3.28
2500mm X 1250mm X 0.6mm	5.13
2000mm X 1000mm X 0.7mm	3.83
2500mm X 1250mm X 0.7mm	5.99
2000mm X 1000mm X 0.8mm	4.38
2500mm X 1250mm X 0.8mm	6.84
2438mm X 1219mm X 0.9mm	7.32
2000mm X 1000mm X 1.0mm	5.47
2500mm X 1250mm X 1.0mm	8.55
3000mm X 1250mm X 1.0mm	10.26
2000mm X 1000mm X 1.2mm	6.57
2438mm X 1219mm X 1.2mm	9.76
2500mm X 1250mm X 1.2mm	10.26
3000mm X 1250mm X 1.2mm	12.32
3000mm X 1500mm X 1.2mm	14.78
2000mm X 1000mm X 1.5mm	8.21
2500mm X 1000mm X 1.5mm	10.26
3000mm X 1000mm X 1.5mm	12.32
3100mm X 1000mm X 1.5mm	12.73
2500mm X 1250mm X 1.5mm	12.83
3000mm X 1250mm X 1.5mm	15.40
3250mm X 1250mm X 1.5mm	16.68
3500mm X 1250mm X 1.5mm	17.96
3750mm X 1250mm X 1.5mm	19.25
4000mm X 1250mm X 1.5mm	20.53
2500mm X 1500mm X 1.5mm	15.40

continued...

Size	KG/Sheet
3000mm X 1500mm X 1.5mm	18.48
4000mm X 1500mm X 1.5mm	24.63
2438mm x 1219mm x 1.9mm	15.46
2500mm x 1250mm x 1.9mm	16.25
3100mm x 1250mm x 1.9mm	20.15
3000mm x 1500mm x 1.9mm	23.40
2000mm X 1000mm X 2.0mm	10.95
2500mm X 1000mm X 2.0mm	13.69
3000mm X 1000mm X 2.0mm	16.42
4000mm X 1000mm X 2.0mm	21.90
2500mm X 1250mm X 2.0mm	17.11
3000mm X 1250mm X 2.0mm	20.53
3100mm X 1250mm X 2.0mm	21.21
3250mm X 1250mm X 2.0mm	22.24
3500mm X 1250mm X 2.0mm	23.95
3750mm X 1250mm X 2.0mm	25.66
4000mm X 1250mm X 2.0mm	27.37
3000mm X 1400mm X 2.0mm	22.99
4000mm X 1400mm X 2.0mm	30.66
2500mm X 1500mm X 2.0mm	20.53
3000mm X 1500mm X 2.0mm	24.63
3100mm X 1500mm X 2.0mm	25.46
3250mm X 1500mm X 2.0mm	26.69
3500mm X 1500mm X 2.0mm	28.74
3750mm X 1500mm X 2.0mm	30.79
4000mm X 1500mm X 2.0mm	32.85
4000mm X 2000mm X 2.0mm	43.79
2438mm x 1219mm x 2.48mm	20.17

continued...

Size	KG/Sheet
2000mm X 1000mm X 2.5mm	13.69
2500mm X 1250mm X 2.5mm	21.38
3000mm X 1500mm X 2.5mm	30.79
2438mm x 1219mm x 2.79mm	22.70
2438mm x 1219mm x 2.9mm	23.59
2500mm x 1250mm x 2.9mm	24.80
3100mm x 1250mm x 2.9mm	30.76
3000mm x 1500mm x 2.9mm	35.72
4000mm x 2000mm x 2.9mm	63.50
2000mm X 1000mm X 3.0mm	16.42
2500mm X 1000mm X 3.0mm	20.53
3000mm X 1000mm X 3.0mm	24.63
2500mm X 1250mm X 3.0mm	25.66
3000mm X 1250mm X 3.0mm	30.79
3100mm X 1250mm X 3.0mm	31.82
3250mm X 1250mm X 3.0mm	33.36
3500mm X 1250mm X 3.0mm	35.92
3750mm X 1250mm X 3.0mm	38.49
4000mm X 1250mm X 3.0mm	41.06
3000mm X 1400mm X 3.0mm	34.49
4000mm X 1400mm X 3.0mm	45.98
2500mm X 1500mm X 3.0mm	30.79
3250mm X 1500mm X 3.0mm	40.03
3000mm X 1500mm X 3.0mm	36.95
3100mm X 1500mm X 3.0mm	38.18
3500mm X 1500mm X 3.0mm	43.11
3750mm X 1500mm X 3.0mm	46.19
4000mm X 2000mm X 3.0mm	65.69

Aluminium Sheet

Aluminium Sheet Alloy 3103 H14

Size	KG/Sheet
2500mm X 1250mm X 1.5mm	12.92
2500mm X 1250mm X 2.0mm	17.23
2500mm X 1250mm X 3.0mm	25.85
3000mm X 1250mm X 3.0mm	31.02

Aluminium Sheet Alloy 5083 H111

Size	KG/Sheet
2500mm X 1250mm X 1.5mm	12.64
2500mm X 1250mm X 2.0mm	16.85
2500mm X 1250mm X 3.0mm	25.28

Aluminium Sheet Alloy 6082 T6

Size	KG/Sheet
2500mm X 1250mm X 2.0mm	17.04
2500mm X 1250mm X 3.0mm	25.57

Aluminium Architectural Sheet Alloy 1050A H14/H24 PVC Coated one side

Size	KG/Sheet
2500mm X 1600mm X 2.0mm	21.90
3000mm X 1600mm X 2.0mm	26.28
2500mm X 1750mm X 2.0mm	23.95
3000mm X 1750mm X 2.0mm	28.74
4000mm X 1750mm X 2.0mm	38.32
3000mm X 2000mm X 2.0mm	32.85
2500mm X 1600mm X 3.0mm	32.85
3000mm X 1600mm X 3.0mm	39.41
4000mm X 1600mm X 2.0mm	35.03
4000mm X 1600mm X 3.0mm	52.55
2500mm X 1750mm X 3.0mm	35.92
3000mm X 1750mm X 3.0mm	43.11
4000mm X 1750mm X 3.0mm	57.48
3000mm X 2000mm X 3.0mm	49.27

Aluminium Sheet Alloy 5251 H22

Size	KG/Sheet
2000mm X 1000mm X 1.0mm	5.43
2500mm X 1250mm X 1.0mm	8.49
2000mm X 1000mm X 1.2mm	6.52
2500mm X 1250mm X 1.2mm	10.19
2000mm X 1000mm X 1.5mm	8.15
2500mm X 1250mm X 1.5mm	12.74
3000mm X 1500mm X 1.5mm	18.34
2000mm X 1000mm X 2.0mm	10.87
2500mm X 1250mm X 2.0mm	16.98
3000mm X 1500mm X 2.0mm	24.45
2000mm X 1000mm X 2.5mm	13.58
2500mm X 1250mm X 2.5mm	21.23
2000mm X 1000mm X 3.0mm	16.30
2500mm X 1250mm X 3.0mm	25.47
3000mm X 1500mm X 3.0mm	36.68



Aluminium Painted Sheet



Aluminium Painted Sheet, Alloy 3105/3003 H44 VC1 - White Painted and Vinyl Coated One Side

Size	KG/Sheet
2000mm X 1000mm X 0.5mm	2.80
2500mm X 1250mm X 0.5mm	4.30
2000mm X 1000mm X 0.6mm	3.30
2500mm X 1250mm X 0.6mm	5.20
2500mm X 1250mm X 0.9mm	7.62
2500mm X 1250mm X 1.2mm	10.20
2500mm X 1250mm X 1.5mm	12.80
2500mm X 1250mm X 2.0mm	15.50

Stucco Sheet



Aluminium Stucco Sheet Alloy 1050A H14

Size	KG/Sheet
2000mm X 1000mm X 0.5mm	2.74
2500mm X 1250mm X 0.5mm	4.28
2000mm X 1000mm X 0.6mm	3.29
2500mm X 1250mm X 0.6mm	5.13
2000mm X 1000mm X 0.7mm	3.83
2500mm X 1250mm X 0.7mm	5.99
2000mm X 1000mm X 0.8mm	4.38
2500mm X 1250mm X 0.8mm	6.84
3000mm X 1250mm X 0.9mm	9.24
3000mm X 1500mm X 0.9mm	11.1
2500mm X 1250mm X 1.0mm	8.55
2500mm X 1250mm X 1.2mm	10.3
3000mm X 1250mm X 1.2mm	12.3
3000mm X 1500mm X 1.2mm	14.8

Treadplate



Alco TripleGrip Aluminium Treadplate Alloy 5052 H32

Size	KG/Plate
2500 X 1250 X 1.5mm	13.9
2500 X 1250 X 2.0mm	18.1
2500 X 1250 X 3.0mm	26.6



Aluminium 5-Bar Treadplate Alloy 5754 H114

Size	KG/Plate
2438mm x 1219mm x 1.95mm	16.5
2438mm X 1219mm X 2.0mm	17.8
2500mm X 1250mm X 2.0mm	18.7
3000mm X 1500mm X 2.0mm	26.8
2438mm x 1219mm x 2.95mm	24.9
2000mm X 1000mm X 3.0mm	17.3
2438mm X 1219mm X 3.0mm	25.7
2500mm X 1250mm X 3.0mm	27.0
3000mm X 1500mm X 3.0mm	38.9
2438mm x 1219mm x 4.4mm	37.2
2000mm X 1000mm X 4.5mm	25.0
2438mm X 1219mm X 4.5mm	37.2
2500mm X 1250mm X 4.5mm	39.2
3000mm X 1500mm X 4.5mm	56.3
2438mm X 1219mm X 6.0mm	49.2
2500mm X 1250mm X 6.0mm	51.7
3000mm X 1500mm X 6.0mm	74.3

Aluminium

Round Bar

Aluminium Round Bar Alloy 6026 T9

Size	KG/Metre
3/8" DIA (9.525mm)	0.19
7/16" DIA (11.112mm)	0.26
1/2" DIA (12.7mm)	0.34
16mm DIA	0.54
3/4" DIA (19.05mm)	0.77
20mm DIA	0.85
7/8" DIA (22.225mm)	1.05
1" DIA (25.4mm)	1.37
1 1/8" DIA (28.58mm)	1.73
1 1/4" DIA (31.75mm)	2.14
35mm DIA	2.60
1 1/2" DIA (38.1mm)	3.08
40mm DIA	3.52
15/8" DIA (41.28mm)	3.61
1 3/4" DIA (44.45mm)	4.19
2" DIA (50.8mm)	5.47
2 1/4" DIA (57.15mm)	6.93
23/8" DIA (60.33)	7.72
2 1/2" DIA (63.5mm)	8.55
3" DIA (76.2mm)	12.31
3 1/2" DIA (88.9mm)	16.76
4" DIA (101.6mm)	21.89

Aluminium Round Bar Alloy 2011 T3

Size	KG/Metre
7/16" DIA (11.112mm)	0.28
1/2" DIA (12.7mm)	0.36
9/16" DIA (14.287mm)	0.46
5/8" DIA (15.875mm)	0.56
3/4" DIA (19.05mm)	0.81
7/8" DIA (22.225mm)	1.10
11/16" DIA (17.462mm)	0.68
13/16" DIA (20.637mm)	0.95
1" DIA (25.4mm)	1.44
1 1/8" DIA (28.58mm)	1.82
1 1/4" DIA (31.75mm)	2.25
15/16" DIA (33.337mm)	2.48
13/8" DIA (34.93mm)	2.72
1 1/2" DIA (38.1mm)	3.24
15/8" DIA (41.28mm)	3.80
1 3/4" DIA (44.45mm)	4.41
17/8" DIA (47.65mm)	5.06
2" DIA (50.8mm)	5.76
2 1/4" DIA (57.15mm)	7.29
2 1/2" DIA (63.5mm)	8.99
25/8" DIA (66.67mm)	9.92
2 3/4" DIA (69.85mm)	10.88
3" DIA (76.2mm)	12.95
3 1/4" DIA (82.55mm)	15.20
3 1/2" DIA (88.9mm)	17.63
4" DIA (101.6mm)	23.02
4 1/2" DIA (114.3mm)	29.14



Aluminium

Round Bar

Aluminium Round Bar Alloy 6082 T6



Size	KG/Metre
¼" DIA (6.35mm)	0.09
5/16" DIA (7.937mm)	0.13
3/8" DIA (9.525mm)	0.19
½" DIA (12.7mm)	0.34
5/8" DIA (15.875mm)	0.53
¾" DIA (19.05mm)	0.77
7/8" DIA (22.225mm)	1.05
1" DIA (25.4mm)	1.37
1 1/8" DIA (28.58mm)	1.73
1 ¼" DIA (31.75mm)	2.14
1 3/8" DIA (34.93mm)	2.59
1 ½" DIA (38.1mm)	3.08
1 5/8" DIA (41.28mm)	3.61
1 ¾" DIA (44.45mm)	4.19
1 7/8" DIA (47.65mm)	4.81
2" DIA (50.8mm)	5.47
2 1/8" DIA (53.975mm)	6.18
2 ¼" DIA (57.15mm)	6.93
2 3/8" DIA (60.33mm)	7.72
2 ½" DIA (63.5mm)	8.55
2 5/8" DIA (66.67mm)	9.43
2 ¾" DIA (69.85mm)	10.35
3" DIA (76.2mm)	12.31
3 ¼" DIA (82.55mm)	14.45
3 ½" DIA (88.9mm)	16.76

Size	KG/Metre
3 ¾" DIA (95.25mm)	19.24
4" DIA (101.6mm)	21.89
4 ¼" DIA (107.95mm)	24.71
4 ½" DIA (114.3mm)	27.70
4 ¾" DIA (120.65mm)	30.87
5" DIA (127.0mm)	34.20
5 ¼" DIA (133.35mm)	37.71
5 ½" DIA (139.7mm)	41.39
5 ¾" DIA (146.05mm)	45.23
6" DIA (152.4mm)	49.25
6 ½" DIA (165.1mm)	57.80
7" DIA (177.8mm)	67.04
7 ¼" DIA (184.15mm)	71.91
7 ½" DIA (190.5mm)	76.96
8" DIA (203.2mm)	87.56
8 ½" DIA (215.9mm)	98.85
9" DIA (228.6mm)	110.82
9 ½" DIA (241.3mm)	123.47
10" DIA (254.0mm)	136.81
12" DIA (304.8mm)	197.01
13" DIA (330.20mm)	231.21
14" DIA (355.60mm)	268.15
15" DIA (381.0mm)	307.83
16" DIA (406.40mm)	350.24

continued...

Aluminium

Flat Bar

Aluminium Flat Bar Alloy 6082 T6



Size	KG/Metre
3/8" X 1/4"	0.16
1/2" X 1/4"	0.22
1/2" X 3/8"	0.33
5/8" X 1/8"	0.14
5/8" X 3/16"	0.20
5/8" X 1/4"	0.27
5/8" X 3/8"	0.41
5/8" X 1/2"	0.54
3/4" X 1/8"	0.16
3/4" X 3/16"	0.24
3/4" X 1/4"	0.33
3/4" X 3/8"	0.49
3/4" X 1/2"	0.65
3/4" X 5/8"	0.82
1" X 1/8"	0.22
1" X 3/16"	0.33
1" X 1/4"	0.44
1" X 5/16"	0.54
1" X 3/8"	0.65
1" X 1/2"	0.87
1" X 5/8"	1.09
1" X 3/4"	1.31
1 1/4" X 1/8"	0.27
1 1/4" X 3/16"	0.41
1 1/4" X 1/4"	0.54
1 1/4" X 3/8"	0.82

continued...

Size	KG/Metre
1 1/4" X 1/2"	1.09
1 1/4" X 5/8"	1.36
1 1/4" X 3/4"	1.63
1 1/4" X 1"	2.18
1 1/2" X 1/8"	0.33
1 1/2" X 3/16"	0.49
1 1/2" X 1/4"	0.65
1 1/2" X 3/8"	0.98
1 1/2" X 1/2"	1.31
1 1/2" X 5/8"	1.63
1 1/2" X 3/4"	1.96
1 1/2" X 1"	2.61
1 1/2" X 1 1/4"	3.27
1 3/4" X 1/4"	0.76
1 3/4" X 3/8"	1.14
1 3/4" X 1/2"	1.52
1 3/4" X 3/4"	2.29
1 3/4" X 1"	3.05
1 3/4" X 1 1/4"	3.81
2" X 1/8"	0.44
2" X 3/16"	0.65
2" X 1/4"	0.87
2" X 3/8"	1.31
2" X 1/2"	1.74
2" X 5/8"	2.18
2" X 3/4"	2.61

continued...

Size	KG/Metre
2" X 1"	3.48
2" X 1 1/4"	4.35
2" X 1 1/2"	5.23
2 1/2" X 3/16"	0.82
2 1/2" X 1/4"	1.09
2 1/2" X 3/8"	1.63
2 1/2" X 1/2"	2.18
2 1/2" X 3/4"	3.27
2 1/2" X 1"	4.35
2 1/2" X 1 1/2"	6.53
2 1/2" X 2"	8.71
3" X 3/16"	0.98
3" X 1/4"	1.31
3" X 3/8"	1.96
3" X 1/2"	2.61
3" X 5/8"	3.27
3" X 1"	5.23
3" X 2"	10.45
3 1/2" X 1/4"	1.52
3 1/2" X 1/2"	3.05
4" X 1/8"	0.87
4" X 3/16"	1.31
4" X 1/4"	1.74
4" X 3/8"	2.61
4" X 1/2"	3.48
4" X 5/8"	4.36

continued...

Aluminium

Flat Bar



Aluminium Flat Bar Alloy 6082 T6 (continued)

Size	KG/Metre
4" X 3/4"	5.23
4" X 1"	6.97
4" X 1 1/4"	8.71
4" X 2"	13.94
5" X 1/2"	4.35
5" X 3/4"	2.18
6" X 1/4"	2.61
6" X 3/8"	3.92
6" X 1/2"	5.23
6" X 1"	10.45

Aluminium Flat Bar Alloy 6063A T6

Size	KG/Metre
1/2" X 1/8"	0.11
1/2" X 3/16"	0.16
7/8" X 1/8"	0.19
1" X 1/16"	0.11
1" X 1/8"	0.22
1" X 3/16"	0.33
1 1/2" X 1/8"	0.33
2" X 1/8"	0.44
3" X 1/8"	0.65
4" X 1/8"	0.87

Square Bar



Aluminium Square Bar Alloy 6082 T6

Size	KG/Metre
1/4" SQUARE	0.11
5/16" SQUARE	0.17
3/8" SQUARE	0.25
1/2" SQUARE	0.44
5/8" SQUARE	0.68
3/4" SQUARE	0.98
7/8" SQUARE	1.34
1" SQUARE	1.74
1 1/4" SQUARE	2.72
1 1/2" SQUARE	3.92
1 3/4" SQUARE	5.34
2" SQUARE	6.97
2 1/2" SQUARE	10.90
3" SQUARE	15.80
3 1/2" SQUARE	21.40
4" SQUARE	27.90

Aluminium

Equal Angle

Aluminium Equal Angle Alloy 6082 T6

Size	KG/Metre
½" X ½" X 1/8"	0.19
¾" X ¾" X 1/8"	0.30
1" X 1" X 1/8"	0.41
1" X 1" X 3/16"	0.59
1" X 1" X ¼"	0.76
1¼" X 1¼" X 1/8"	0.52
1¼" X 1¼" X 3/16"	0.75
1¼" X 1¼" X ¼"	0.98
1½" X 1½" X 1/8"	0.63
1½" X 1½" X 3/16"	0.92
1½" X 1½" X ¼"	1.20
1¾" X 1¾" X 3/16"	1.08
1¾" X 1¾" X ¼"	1.42
2" X 2" X 1/8"	0.85
2" X 2" X 3/16"	1.24
2" X 2" X ¼"	1.63
2" X 2" X 3/8"	2.37
2½" X 2½" X 3/16"	1.57
2½" X 2½" X ¼"	2.07
3" X 3" X 1/8"	1.28
3" X 3" X 3/16"	1.90
3" X 3" X ¼"	2.50
3" X 3" X 3/8"	3.68
4" X 4" X ¼"	3.37
4" X 4" X 3/8"	4.98
6" X 6" X ½"	10.02

Aluminium Equal Angle Alloy 6063A T6

Size	KG/Metre
½" X ½" X 1/16"	0.10
5/8" X 5/8" X 1/16"	0.13
5/8" X 5/8" X 1/8"	0.25
¾" X ¾" X 1/16"	0.16
¾" X ¾" X 1/8"	0.30
7/8" X 7/8" X 1/8"	0.35
25mm X 25mm X 3mm	0.38
1" X 1" X 1/16"	0.21
1" X 1" X 1/8"	0.41
1¼" X 1¼" X 1/16"	0.27
1¼" X 1¼" X 1/8"	0.52
1½" X 1½" X 1/16"	0.32
1½" X 1½" X 1/8"	0.63
1¾" X 1¾" X 1/8"	0.74
50mm X 50mm X 3mm	0.79
2" X 2" X 1/16"	0.43
2" X 2" X 1/8"	0.85
2" X 2" X 3/16"	1.24
2½" X 2½" X 1/8"	1.06



Aluminium

Unequal Angle

Aluminium UN-Equal Angle Alloy 6063A T6

Size	KG/Metre
¾" X ½" X 1/16"	0.13
¾" X ½" X 1/8"	0.25
1" X ½" X 1/16"	0.16
1" X 1/2" X 1/8"	0.30
1" X 5/8" X 1/8"	0.33
1" X ¾" X 1/16"	0.18
1" X ¾" X 1/8"	0.35
1¼" X ½" X 1/8"	0.35
1¼" X ¾" X 1/8"	0.41
1¼" X 1" X 1/8"	0.46
1½" X ¾" X 1/8"	0.46
1½" X 1" X 1/8"	0.52
1¾" X 1" X 1/8"	0.57
2" X ½" X 1/8"	0.52
2" X ¾" X 1/8"	0.57
50mm X 25mm X 3.0mm	0.58
2" X 1" X 1/8"	0.63
2" X 1½" X 1/8"	0.74
2½" X 1" X 1/8"	0.74
3" X 2" X 1/8"	1.06
4" X 1" X 1/8"	1.06
4" X 2" X 1/8"	1.28

Aluminium UN-Equal Angle Alloy 6082 T6

Size	KG/Metre
1½" X 1" X 1/8"	0.52
2" X 1" X 1/8"	0.63
2" X 1" X 3/16"	0.92
2" X 1" X ¼"	1.20
2" X 1½" X 1/8"	0.74
2" X 1½" X 3/16"	1.08
2" X 1½" X ¼"	1.41
2½" X 1½" X 3/16"	1.24
2½" X 1½" X ¼"	1.63
3" X 1" X 1/8"	0.85
3" X 1" X ¼"	1.64
3" X 1½" X 1/8"	0.95
3" X 1½" X 3/16"	1.41
3" X 1½" X ¼"	1.85
3" X 2" X 1/8"	1.06
3" X 2" X 3/16"	1.57
3" X 2" X ¼"	2.07
4" X 2" X ¼"	2.50
4" X 3" X ¼"	2.94
6" X 3" X 3/8"	5.64



Aluminium Channel



Aluminium Channel Alloy 6063/6063A T6

Size	KG/Metre
3/8" X 3/8" X 1/16" X 1/16"	0.11
1/2" X 1/2" X 1/16" X 1/16"	0.15
1/2" X 1/2" X 1/8" X 1/8"	0.27
5/8" X 5/8" X 1/16" X 1/16"	0.19
5/8" X 5/8" X 1/8" X 1/8"	0.35
3/4" X 3/4" X 1/16" X 1/16"	0.23
3/4" X 3/4" X 1/8" X 1/8"	0.44
7/8" X 7/8" X 1/8" X 1/8"	0.52
1" X 1/2" X 1/8" X 1/8"	0.38
1" X 3/4" X 1/8" X 1/8"	0.49
1" X 1" X 1/16" X 1/16"	0.31
1" X 1" X 1/8" X 1/8"	0.60
1 1/4" X 3/4" X 1/8" X 1/8"	0.55
1 1/4" X 1" X 1/8" X 1/8"	0.65
1 1/4" X 1 1/4" X 1/8" X 1/8"	0.76
1 1/2" X 3/4" X 1/8" X 1/8"	0.60
1 1/2" X 1 1/2" X 1/8" X 1/8"	0.93
1 3/4" X 1" X 1/8" X 1/8"	0.76
2" X 1/2" X 1/8" X 1/8"	0.60
2" X 3/4" X 1/8" X 1/8"	0.71
2" X 1" X 1/8" X 1/8"	0.82
2" X 1" X 3/16" X 3/16"	1.18
2" X 1 1/2" X 1/8" X 1/8"	1.04
2" X 2" X 1/8" X 1/8"	1.25
2 1/2" X 1" X 1/8" X 1/8"	0.93
4" X 2" X 1/8" X 1/8"	1.69



Aluminium Channel Alloy 6082 T6

Size	KG/Metre
1 1/4" X 1 1/4" X 1/8" X 1/8"	0.76
1 1/2" X 1 1/2" X 1/8" X 1/8"	0.49
1 1/2" X 1" X 1/8" X 1/8"	0.71
1 1/2" X 1 1/2" X 1/8" X 1/8"	0.93
1 1/2" X 1 1/2" X 3/16" X 3/16"	1.35
1 1/2" X 1 1/2" X 1/4" X 1/4"	1.74
2" X 1" X 1/8" X 1/8"	0.82
2" X 1" X 1/4" X 1/4"	1.52
2" X 1 1/2" X 1/4" X 1/4"	1.96
2" X 2" X 3/16" X 3/16"	1.84
2" X 2" X 1/4" X 1/4"	2.40
2 1/4" X 1 1/4" X 3/16" X 3/16"	1.43
2 1/2" X 1 1/4" X 3/16" X 3/16"	1.51
3" X 1" X 1/8" X 1/8"	1.04
3" X 1 1/2" X 1/8" X 1/8"	1.25
3" X 1 1/2" X 3/16" X 3/16"	1.84
3" X 1 1/2" X 1/4" X 5/16"	2.67
3" X 2" X 1/8" X 1/8"	1.47
3" X 2" X 3/16" X 3/16"	2.16
3" X 2" X 1/4" X 1/4"	2.83
3 1/2" X 1 1/2" X 1/4" X 5/16"	2.95
4" X 2" X 1/4" X 5/16"	3.65
5" X 2" X 1/4" X 5/16"	4.08
6" X 2" X 1/4" X 5/16"	4.52
6" X 3" X 1/4" X 3/8"	6.21
6" X 3" X 3/8" X 1/2"	8.49
8" X 3" X 3/8" X 1/2"	9.80
10" X 3" X 3/8" X 1/2"	11.10

Tee Section



Aluminium Tee Alloy 6063A T6

Size	KG/Metre
3/4" X 3/4" X 1/8"	0.30
1" X 1" X 1/8"	0.41
1 1/4" X 1 1/4" X 1/8"	0.52
1 1/2" X 1 1/2" X 1/8"	0.63
2" X 1" X 1/8"	0.63
2" X 2" X 1/8"	0.85

Aluminium Tee Alloy 6082 T6

Size	KG/Metre
1 1/2" X 1 1/2" X 3/16"	0.92
1 1/2" X 1 1/2" X 1/4"	1.20
2" X 2" X 3/16"	1.25
2" X 2" X 1/4"	1.63
3" X 3" X 1/4"	2.51

Aluminium

Round Tube

Aluminium Tube Alloy 6082 T6

Size	KG/Metre
½" O/D X 10SWG	0.26
5/8" O/D X 10SWG	0.35
¾" O/D X 10SWG	0.44
7/8" O/D X 10SWG	0.52
1" O/D X 16SWG	0.33
1" O/D X 10SWG	0.61
1" O/D X 3/16"	0.83
1" O/D X ¼"	1.03
1 1/8" O/D X 10SWG	0.70
1 ¼" O/D X 16SWG	0.40
1 ¼" O/D X 3/16"	1.10
1 ¼" O/D X 10SWG	0.80
1 3/8" O/D X 10SWG	0.87
1 ½" O/D X 10SWG	0.96
1 ½" O/D X 3/16"	1.35
1 ½" O/D X ¼"	1.71
1 5/8" O/D X 10SWG	1.00
1 5/8" O/D X 3/16"	1.50
1 ¾" O/D X 16SWG	0.59
1 ¾" O/D X 10SWG	1.14
1 7/8" O/D X 10SWG	1.22
2" O/D X 16SWG	0.70
2" O/D X 10SWG	1.30
2" O/D X 3/16"	1.90
2" O/D X ¼"	2.40
2 ¼" O/D X 16SWG	0.77

continued...

Aluminium Tube Alloy 6082 T6 (continued)

Size	KG/Metre
2 ¼" O/D X 10SWG	1.49
2 ½" O/D X 16SWG	0.90
2 ½" O/D X 10SWG	1.60
2 ½" O/D X 3/16"	2.40
2 ½" O/D X ¼"	3.10
2 ½" O/D X 3/8"	4.40
3 ½" O/D X ¼"	4.45
2 ¾" O/D X 10SWG	1.80
3" O/D X 16SWG	1.00
3" O/D X 10SWG	2.00
3" O/D X 3/16"	2.90
3" O/D X ¼"	3.80
3 ½" O/D X 16SWG	1.21
3 ½" O/D X 10SWG	2.36
4" O/D X 10SWG	2.71
4" O/D X ¼"	5.13
4 ½" O/D X 10SWG	3.00
4 ½" O/D X ¼"	5.80
5" O/D X 10SWG	3.30
5" O/D X ¼"	6.50
6" O/D X 10SWG	4.03
6" O/D X ¼"	7.90
6 ½" O/D X ¼"	8.55

Aluminium Tube Alloy 6063 T6

Size	KG/Metre
3/8" O/D X 16SWG	0.11
½" O/D X 18SWG	0.12
½" O/D X 16SWG	0.15
5/8" O/D X 18SWG	0.15
5/8" O/D X 16SWG	0.20
¾" O/D X 18SWG	0.18
¾" O/D X 16SWG	0.24
¾" O/D X 10SWG	0.44
7/8" O/D X 18SWG	0.22
7/8" O/D X 16SWG	0.28
7/8" O/D X 10SWG	0.52
1" O/D X 18SWG	0.25
1" O/D X 10SWG	0.61
1 ¼" O/D X 18SWG	0.32
1 1/8" O/D X 16SWG	0.37
1 ½" O/D X 18SWG	0.38
1 ¼" O/D X 16SWG	0.40
1 ¼" O/D X 10SWG	0.80
1 3/8" O/D X 16SWG	0.46
1 5/8" O/D X 16SWG	0.50
1 ½" O/D X 16SWG	0.50
1 ½" O/D X 10SWG	0.96
2" O/D X 16SWG	0.70
2" O/D X 10SWG	1.30
2 ¼" O/D X 10SWG	1.49
3" O/D X 10SWG	2.00
4" O/D X 16SWG	1.38
4" O/D X 16SWG	1.38



Aluminium

Round Tube



Aluminium Tube Alloy 6082 T6 (BS1474)

Size	KG/Metre
1 3/4" OD X 10SWG	1.14
2" OD X 1/4"	2.39
2" OD X 3/16"	1.86
3.1/2" OD X 1/4"	4.45

Scaffold Tube



Scaffold tube is drift tested to BS 1139

Size	KG/Metre
129/32 o/d x 7swg (0.176"/4.47mm)	1.53

Aluminium

Box Section - Rectangular



Aluminium Rectangular Tube Alloy 6063 T6

Size	KG/Metre
1½" X ¾" X 1/16"	0.46
1½" X 1" X 16SWG	0.53
1½" X 1" X 10SWG	1.00
50mm X 25mm X 3.0mm	1.18
2" X 1" X 10SWG	1.22
2" X 1½" X 10SWG	1.45
3" X 1" X 10SWG	1.67
3" X 1½" X 10SWG	1.89
3" X 2" X 10SWG	2.11
4" X 1" X 10SWG	2.11
4" X 1¾" X 10SWG	2.45
4" X 2" X 10SWG	2.56
6" X 2" X 10SWG	3.45
6" X 3" X 3/8"	10.80

Box Section - Square



Aluminium Square Tube Alloy 6082 T6

Size	KG/Metre
½" SQ X 16SWG	0.20
¾" SQ X 16SWG	0.31
1" SQ X 16SWG	0.42
1" SQ X 10SWG	0.78
1¼" SQ X 16SWG	0.53
1¼" SQ X 10SWG	1.00
1½" SQ X 16SWG	0.64
1½" SQ X 10SWG	1.22
1¾" SQ X 10SWG	1.45
2" SQ X 16SWG	0.87
2" SQ X 10SWG	1.67
50mm SQ X 3.0mm	1.52
2½" SQ X 10SWG	2.12
3" SQ X 10SWG	2.56



Aluminium Square Tube Alloy 6063 T6

Size	KG/Metre
1" SQ X 10SWG	0.78
1¼" SQ X 16SWG	0.53
1½" SQ X 10SWG	1.22
2" SQ X 10SWG	1.67
2" SQ X ¼"	3.05
4" SQ X 10SWG	3.45
4" SQ X ¼"	6.53

Aluminium Mouldings



These are a selection of the many shapes available and may not be shown at actual size

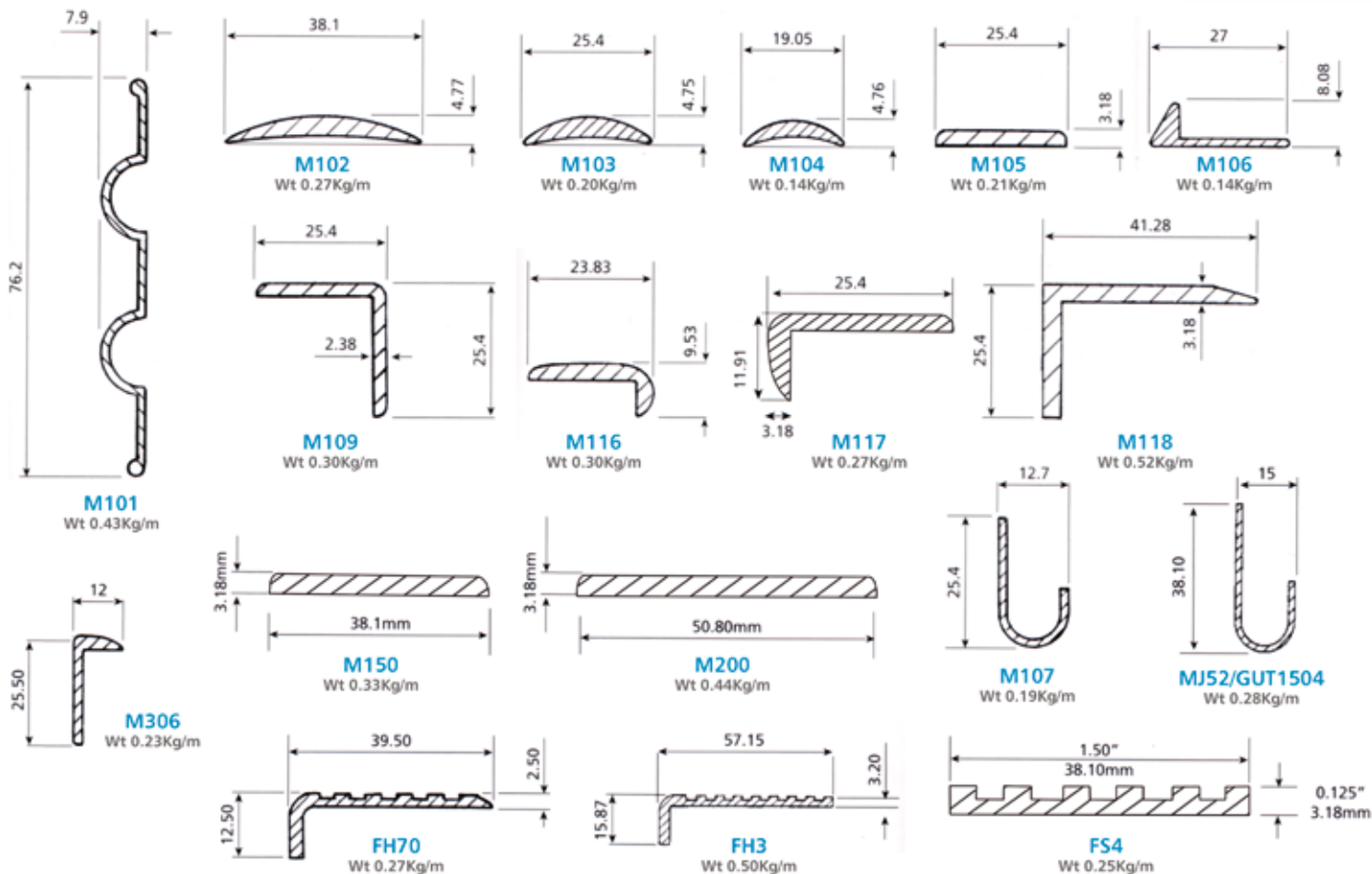

Stainless Steel

Contents

Plate	20
Sheet	21
Circle Polished Stainless Steel Sheet	23
Equal Angle.....	23
Round Bar	24
Hexagon Bar.....	26
Square Bar.....	26
Flat Bar - Hot Rolled	27
Flat Bar - Rolled Edge	28
Structural & Decorative Tube - Round.....	29
Structural & Decorative Tube - Square.....	30
Structural & Decorative Tube - Rectangular	32
Pipe	34
Butt Weld Fittings	36
Flanges.....	40
Metric Tube and Fittings.....	42
Seamless Tube	43
BSP Fittings	45
Hygienic Tube and Fittings	46
Handrail Tube and Fittings.....	47
Slotted Tube system and fittings	49
Accessories - Adhesive & Cleaners	50



Stainless Steel

Plate



Stainless Steel Hot Rolled Plate Grade 1.4003

Size	KG/Plate
2000mm X 1000mm X 3.0mm	48
2500mm X 1250mm X 3.0mm	75
3000mm X 1500mm X 3.0mm	108
2000mm X 1000mm X 4.0mm	64
2500mm X 1250mm X 4.0mm	100
3000mm X 1500mm X 4.0mm	144
2000mm X 1000mm X 5.0mm	80
2500mm X 1250mm X 5.0mm	125
2500mm X 1250mm X 6.0mm	150
3000mm X 1500mm X 6.0mm	216
2500mm X 1250mm X 8.0mm	200
3000mm X 1500mm X 8.0mm	288
2500mm X 1250mm X 10.0mm	250
3000mm X 1500mm X 10.0mm	360
2500mm X 1250mm X 12.0mm	300
3000mm X 1500mm X 12.0mm	432

Stainless Steel Cold Rolled Plate Grades 1.4307 (304L) & 1.4404 (316L) PVC Coated 1 Side

Size	KG/Plate
4000mm X 2000mm X 4.0mm	256
4000mm X 2000mm X 5.0mm	320
4000mm X 2000mm X 6.0mm	384

Stainless Steel Hot Rolled Plate Grades 1.4307 (304L) & 1.4404 (316L)

Size	KG/Plate
2000mm X 1000mm X 3.0mm	48
2500mm X 1250mm X 3.0mm	75
3000mm X 1500mm X 3.0mm	108
2000mm X 1000mm X 4.0mm	64
2500mm X 1250mm X 4.0mm	100
3000mm X 1500mm X 4.0mm	144
2000mm X 1000mm X 5.0mm	80
2500mm X 1250mm X 5.0mm	125
3000mm X 1500mm X 5.0mm	180
4000mm X 2000mm X 5.0mm	320
2000mm X 1000mm X 6.0mm	96
2500mm X 1250mm X 6.0mm	150
3000mm X 1500mm X 6.0mm	216
4000mm X 2000mm X 6.0mm	384
6000mm X 2000mm X 6.0mm	576
2000mm X 1000mm X 8.0mm	128
2500mm X 1250mm X 8.0mm	200
3000mm X 1500mm X 8.0mm	288
4000mm X 2000mm X 8.0mm	512
2000mm X 1000mm X 10.0mm	160
2500mm X 1250mm X 10.0mm	250
3000mm X 1500mm X 10.0mm	360
4000mm X 2000mm X 10.0mm	640
6000mm X 2000mm X 10.0mm	960
2500mm X 1250mm X 12.0mm	300
3000mm X 1500mm X 12.0mm	432

Size	KG/Plate
4000mm X 2000mm X 12.0mm	768
2500mm X 1250mm X 15.0mm	375
3000mm X 1500mm X 15.0mm	557
2500mm X 1250mm X 20.0mm	500
3000mm X 1500mm X 20.0mm	720

Stainless Steel Cold Rolled Plate Grades 1.4307 (304L) & 1.4404 (316L)

Size	KG/Plate
2000mm X 1000mm X 4.0mm	64
2500mm X 1250mm X 4.0mm	100
3000mm X 1500mm X 4.0mm	144
2000mm X 1000mm X 5.0mm	80
2500mm X 1250mm X 5.0mm	125
3000mm X 1500mm X 5.0mm	180
2000mm X 1000mm X 6.0mm	96
2500mm X 1250mm X 6.0mm	150
3000mm X 1500mm X 6.0mm	216

Stainless Steel Treadplate BSEN 10088: Part 3 / ASTM A793 / DIN 59220 (T) Pattern 1 Grade AISI 304

Size	KG/Plate
3000mm X 1000mm X 3.0mm	78
3000mm X 1250mm X 3.0mm	98
3000mm X 1250mm X 4.5mm	143
3000mm X 1250mm X 6.0mm	180

continued...

Stainless Steel

Sheet



Stainless Steel Sheet Grade 1.4003 - Cold Rolled
except where shown

Size	KG/Sheet
2500mm X 1250mm X 1.0mm	25.0
2000mm X 1000mm X 1.2mm	19.2
2500mm X 1250mm X 1.2mm	30.0
2000mm X 1000mm X 1.5mm	24.0
2500mm X 1250mm X 1.5mm	37.5
3000mm X 1500mm X 1.5mm	54.0
2000mm X 1000mm X 2.0mm	32.0
2500mm X 1250mm X 2.0mm	50.0
3000mm X 1500mm X 2.0mm	72.0
2500mm X 1250mm X 2.5mm	62.5
2000mm X 1000mm X 3.0mm (HR)	48.0
2500mm X 1250mm X 3.0mm (HR)	75.0
3000mm X 1500mm X 3.0mm (HR)	108.0

Stainless Steel Sheet Grade 1.4016 (430) - Polished
240 Grit and PVC Coated 1 Side

Size	KG/Sheet
2500mm X 1250mm X 0.7mm	17.9
2000mm X 1000mm X 0.9mm	14.7
2500mm X 1250mm X 0.9mm	23.0
2000mm X 1000mm X 1.2mm	19.6
2500mm X 1250mm X 1.2mm	30.7
2000mm X 1000mm X 1.5mm	24.6
2500mm X 1250mm X 1.5mm	38.4

Stainless Steel Sheet Grade 1.4016 (430) - Bright
Annealed

Size	KG/Sheet
2000mm X 1000mm X 0.5mm	8.2
2500mm X 1250mm X 0.5mm	12.8
2000mm X 1000mm X 0.7mm	11.5
2500mm X 1250mm X 0.7mm	17.9
2000mm X 1000mm X 0.9mm	14.7
2500mm X 1250mm X 0.9mm	23.0
2000mm X 1000mm X 1.0mm	16.4
2500mm X 1250mm X 1.0mm	25.6
2000mm X 1000mm X 1.2mm	19.6
2500mm X 1250mm X 1.2mm	30.7
2000mm X 1000mm X 1.5mm	24.6
2500mm X 1250mm X 1.5mm	38.4
2000mm X 1000mm X 2.0mm	32.7
2500mm X 1250mm X 2.0mm	51.2

Stainless Steel Sheet Grade 1.4404 (316L) - Polished
240 Grit and PVC Coated 1 Side

Size	KG/Sheet
2500mm X 1250mm X 0.9mm	23.0
2500mm X 1250mm X 1.2mm	31.2
2500mm X 1250mm X 1.5mm	38.4
3000mm X 1500mm X 1.5mm	55.3
2500mm X 1250mm X 2.0mm	51.2
2500mm X 1250mm X 3.0mm	77.5

Stainless Steel Sheet Grade 1.4301 (304) - Polished
240 Grit and PVC Coated 1 Side

Size	KG/Sheet
2000mm X 1000mm X 0.7mm	11.5
2500mm X 1250mm X 0.7mm	17.9
2000mm X 1000mm X 0.9mm	14.7
2500mm X 1250mm X 0.9mm	23.0
3000mm X 1500mm X 0.9mm	33.2
2000mm X 1000mm X 1.0mm	16.4
2500mm X 1250mm X 1.0mm	25.6
2000mm X 1000mm X 1.2mm	19.6
2500mm X 1250mm X 1.2mm	30.7
3000mm X 1500mm X 1.2mm	44.2
2000mm X 1000mm X 1.5mm	24.6
2500mm X 1250mm X 1.5mm	38.4
3000mm X 1500mm X 1.5mm	55.3
2000mm X 1000mm X 2.0mm	32.7
2500mm X 1250mm X 2.0mm	51.2
3000mm X 1500mm X 2.0mm	73.7
2000mm X 1000mm X 2.5mm	40.9
2500mm X 1250mm X 2.5mm	63.9
3000mm X 1500mm X 2.5mm	92.1
2000mm X 1000mm X 3.0mm	49.6
2500mm X 1250mm X 3.0mm	77.5
3000mm X 1500mm X 3.0mm	111.6

Stainless Steel

Sheet

Stainless Steel Sheet Grade 1.4301 (304) - 2B

Size	KG/Sheet
2000mm X 1000mm X 0.5mm	8.2
2500mm X 1250mm X 0.5mm	12.8
2000mm X 1000mm X 0.7mm	11.5
2500mm X 1250mm X 0.7mm	17.9
2500mm X 1250mm X 0.8mm	20.5
2000mm X 1000mm X 0.9mm	14.7
2500mm X 1250mm X 0.9mm	23.0
3000mm X 1500mm X 0.9mm	33.2
2000mm X 1000mm X 1.0mm	16.4
2500mm X 1250mm X 1.0mm	25.6
2000mm X 1000mm X 1.2mm	19.6
2500mm X 1250mm X 1.2mm	30.7
3000mm X 1500mm X 1.2mm	44.2
2000mm X 1000mm X 1.5mm	24.6
2500mm X 1250mm X 1.5mm	38.4
3000mm X 1500mm X 1.5mm	55.3
2000mm X 1000mm X 2.0mm	32.7
2500mm X 1250mm X 2.0mm	51.2
3000mm X 1500mm X 2.0mm	73.7
4000mm X 2000mm X 2.0mm	128.0
2000mm X 1000mm X 2.5mm	40.9
2500mm X 1250mm X 2.5mm	63.9
3000mm X 1500mm X 2.5mm	92.1
2000mm X 1000mm X 3.0mm	49.6
2500mm X 1250mm X 3.0mm	77.5
3000mm X 1500mm X 3.0mm	111.6
4000mm X 2000mm X 3.0mm	192.0

Stainless Steel Sheet Grade 1.4404 (316L) - 2B

Size	KG/Sheet
2000mm X 1000mm X 0.7mm	11.5
2500mm X 1250mm X 0.7mm	17.9
2000mm X 1000mm X 0.9mm	14.7
2500mm X 1250mm X 0.9mm	23.0
2000mm X 1000mm X 1.2mm	19.6
2500mm X 1250mm X 1.2mm	30.7
3000mm X 1500mm X 1.2mm	44.2
2000mm X 1000mm X 1.5mm	24.6
2500mm X 1250mm X 1.5mm	38.4
3000mm X 1500mm X 1.5mm	55.3
2000mm X 1000mm X 2.0mm	32.7
2500mm X 1250mm X 2.0mm	51.2
3000mm X 1500mm X 2.0mm	73.7
4000mm X 2000mm X 2.0mm	128.0
2000mm X 1000mm X 2.5mm	40.9
2500mm X 1250mm X 2.5mm	63.9
3000mm X 1500mm X 2.5mm	92.1
2000mm X 1000mm X 3.0mm	49.6
2500mm X 1250mm X 3.0mm	77.5
3000mm X 1500mm X 3.0mm	111.6
4000mm X 2000mm X 3.0mm	192.0



Stainless Steel Sheet Grade 1.4301 (304) - OPTISHEEN™ Polished and PVC Coated 1 Side

Size	KG/Sheet
2000mm X 1000mm X 0.9mm	14.7
2500mm X 1250mm X 0.9mm	23.0
2000mm X 1000mm X 1.2mm	19.6
2500mm X 1250mm X 1.2mm	30.7
2000mm X 1000mm X 1.5mm	24.6
2500mm X 1250mm X 1.5mm	38.4
3000mm X 1500mm X 1.5mm	55.3
2500mm X 1250mm X 2.0mm	51.2

Stainless Steel Sheet Grade 1.4301 (304) - 240 Grit Silicon Polished and PVC Coated 1 Side

Size	KG/Sheet
2000mm X 1000mm X 0.9mm	14.7
2500mm X 1250mm X 0.9mm	23.0
2000mm X 1000mm X 1.2mm	19.6
2500mm X 1250mm X 1.2mm	30.7
2000mm X 1000mm X 1.5mm	24.6
2500mm X 1250mm X 1.5mm	38.4
2000mm X 1000mm X 2.0mm	32.7
2500mm X 1250mm X 2.0mm	51.2

Stainless Steel Sheet



Stainless Steel Sheet
Grade 1.4301 (304) - Bright Annealed

Size	KG/Sheet
2500mm X 1250mm X 0.5mm	12.8
2000mm X 1000mm X 0.5mm	8.2
2000mm X 1000mm X 0.6mm	9.8
2500mm X 1250mm X 0.6mm	15.3
2000mm X 1000mm X 0.7mm	11.5
2500mm X 1250mm X 0.7mm	17.9
2500mm X 1250mm X 0.8mm	20.5
2000mm X 1000mm X 0.9mm	14.7
2500mm X 1250mm X 0.9mm	23.0
2000mm X 1000mm X 1.0mm	16.4
2500mm X 1250mm X 1.0mm	25.6
2000mm X 1000mm X 1.2mm	19.6
2500mm X 1250mm X 1.2mm	30.7
2000mm X 1000mm X 1.5mm	24.6
2500mm X 1250mm X 1.5mm	38.4
2000mm X 1000mm X 2.0mm	32.7
2500mm X 1250mm X 2.0mm	51.2

Circle Polished Sheet



Circle Polished Stainless Steel Sheet
Grade 1.4301 (304) - 50mm Circles

Size	KG/Sheet
2500mm x 1250mm x 0.9mm	23.0
2500mm x 1250mm x 1.2mm	30.7
2500mm x 1250mm x 1.5mm	38.4
2500mm x 1250mm x 2.0mm	51.2

Circle Polished Stainless Steel Sheet
Grade 1.4016 (430) - 50mm Circles

Size	KG/Sheet
2500mm x 1250mm x 0.9mm	23.0

Equal Angle



Stainless Steel Angle Grades 1.4307 (304L) & 1.4404 (316L)

Size	KG/Metre
20.0mm X 20.0mm X 3.0mm	0.95
25.0mm X 25.0mm X 3.0mm	1.20
25.0mm X 25.0mm X 5.0mm	1.92
25.0mm X 25.0mm X 6.0mm	2.25
30.0mm X 30.0mm X 3.0mm	1.46
30.0mm X 30.0mm X 5.0mm	2.35
30.0mm X 30.0mm X 6.0mm	2.76
40.0mm X 40.0mm X 3.0mm	1.97
40.0mm X 40.0mm X 5.0mm	3.20
40.0mm X 40.0mm X 6.0mm	3.79
50.0mm X 50.0mm X 3.0mm	2.48
50.0mm X 50.0mm X 5.0mm	4.05
50.0mm X 50.0mm X 6.0mm	4.81
50.0mm X 50.0mm X 10.0mm	7.68
60.0mm X 60.0mm X 5.0mm	4.91
60.0mm X 60.0mm X 6.0mm	5.84
60.0mm X 60.0mm X 10.0mm	9.39
70.0mm X 70.0mm X 6.0mm	6.86
70.0mm X 70.0mm X 10.0mm	11.10
75.0mm X 75.0mm X 6.0mm	7.37
75.0mm X 75.0mm X 10.0mm	11.95
80.0mm X 80.0mm X 6.0mm	7.88
80.0mm X 80.0mm X 10.0mm	12.80
100.0mm X 100.0mm X 6.0mm	9.93
100.0mm X 100.0mm X 10.0mm	16.21

Stainless Steel

Round Bar

Stainless Steel Round Bar Grade 1.4305 (303)



Size	KG/Metre
3.0mm DIA	0.06
1/8" DIA (3.175mm)	0.06
4.0mm DIA	0.10
3/16" DIA (4.762mm)	0.14
5.0mm DIA	0.16
6.0mm DIA	0.22
1/4" DIA (6.35mm)	0.25
7.0mm DIA	0.30
5/16" DIA (7.937mm)	0.39
8.0mm DIA	0.40
3/8" DIA (9.525mm)	0.56
10.0mm DIA	0.62
7/16" DIA (11.112mm)	0.77
12.0mm DIA	0.89
1/2" DIA (12.7mm)	1.00
14.0mm DIA	1.22
9/16" DIA (14.287mm)	1.27
15.0mm DIA	1.40
5/8" DIA (15.875mm)	1.56
16.0mm DIA	1.59
11/16" DIA (17.462mm)	1.89
18.0mm DIA	2.01
3/4" DIA (19.05mm)	2.25
20.0mm DIA	2.48
22.0mm DIA	3.00
7/8" DIA (22.225mm)	3.07

continued...

Size	KG/Metre
24.0mm DIA	3.57
25.0mm DIA	3.88
1" DIA (25.4mm)	4.00
11/8" DIA (28.575mm)	5.07
30.0mm DIA	5.58
1 1/4" DIA (31.75mm)	6.25
13/8" DIA (34.925mm)	7.57
35.0mm DIA	7.60
1 1/2" DIA (38.1mm)	9.01
40.0mm DIA	9.93
15/8" DIA (41.275mm)	10.6
1 3/4" DIA (44.45mm)	12.3
45.0mm DIA	12.6
17/8" DIA (47.625mm)	14.1
50.0mm DIA	15.5
2" DIA (50.8mm)	16.0
21/8" DIA (53.975mm)	18.1
2 1/4" DIA (57.15mm)	20.3
60.0mm DIA	22.3
23/8" DIA (60.325mm)	22.6
2 1/2" DIA (63.5mm)	25.0
25/8" DIA (66.67mm)	27.6
2 3/4" DIA (69.85mm)	30.3
3" DIA (76.2mm)	36.0
3 1/4" DIA (82.55mm)	42.9
3 1/2" DIA (88.9mm)	49.8

continued...

Size	KG/Metre
3 3/4" DIA (95.25mm)	57.1
4" DIA (101.6mm)	65.0
4 1/4" DIA (107.95mm)	73.4
4 1/2" DIA (114.3mm)	82.3
5" DIA (127.0mm)	102
5 3/4" DIA (146.05mm)	134
6" DIA (152.4mm)	146
7" DIA (177.8mm)	199

Stainless Steel

Round Bar

Stainless Steel Round Bar Grades 1.4307 (304L) & 1.4404 (316L)



Size	KG/Metre
3.0mm DIA	0.06
1/8" DIA (3.175mm)	0.06
4.0mm DIA	0.10
3/16" DIA (4.762mm)	0.14
5.0mm DIA	0.16
6.0mm DIA	0.22
1/4" DIA (6.35mm)	0.25
5/16" DIA (7.937mm)	0.39
8.0mm DIA	0.40
3/8" DIA (9.525mm)	0.56
10.0mm DIA	0.62
7/16" DIA (11.112mm)	0.77
12.0mm DIA	0.89
1/2" DIA (12.7mm)	1.00
14.0mm DIA	1.23
9/16" DIA (14.287mm)	1.27
15.0mm DIA	1.40
5/8" DIA (15.875mm)	1.56
16.0mm DIA	1.59
11/16" DIA (17.462mm)	1.91
18.0mm DIA	2.03
3/4" DIA (19.05mm)	2.25
20.0mm DIA	2.48
7/8" DIA (22.225mm)	3.07
24.0mm DIA	3.60
25.0mm DIA	3.88
1" DIA (25.4mm)	4.00

continued...

Size	KG/Metre
11/8" DIA (28.575mm)	5.07
30.0mm DIA	5.58
1 1/4" DIA (31.75mm)	6.25
32.0mm DIA	6.40
13/8" DIA (34.925mm)	7.57
35.0mm DIA	7.60
1 1/2" DIA (38.1mm)	9.01
40.0mm DIA	9.93
15/8" DIA (41.275mm)	10.6
1 3/4" DIA (44.45mm)	12.3
17/8" DIA (47.625mm)	14.2
45.0mm DIA	12.7
50.0mm DIA	15.5
2" DIA (50.8mm)	16.0
21/8" DIA (53.975mm)	18.2
2 1/4" DIA (57.15mm)	20.3
60.0mm DIA	22.3
23/8" DIA (60.325mm)	22.8
2 1/2" DIA (63.5mm)	25.0
25/8" DIA (66.67mm)	27.8
2 3/4" DIA (69.85mm)	30.3
3" DIA (76.2mm)	36.0
3 1/4" DIA (82.55mm)	42.9
3 1/2" DIA (88.9mm)	49.8
3 3/4" DIA (95.25mm)	57.1
4" DIA (101.6mm)	65.0
4 1/4" DIA (107.95mm)	73.4

continued...

Size	KG/Metre
4 1/2" DIA (114.3mm)	82.3
4 3/4" DIA (120.65mm)	92.4
5" DIA (127.0mm)	102
5 1/4" DIA (133.35mm)	112
5 1/2" DIA (139.7mm)	123
5 3/4" DIA (146.05mm)	134
6" DIA (152.4mm)	146
6 1/4" DIA (158.75mm)	159
6 1/2" DIA (165.1mm)	172
7" DIA (177.8mm)	199
185.0mm DIA	217
7 1/2" DIA (190.5mm)	229
8" DIA (203.2mm)	260
8 1/2" DIA (215.9mm)	294
9" DIA (228.6mm)	329
9 1/2" DIA (241.3mm)	369
10" DIA (254.0mm)	406
10 1/2" DIA (266.7mm)	451
11" DIA (279.4mm)	492
12" DIA (304.8mm)	585
340.0mm DIA	728
14" DIA (355.6mm)	802
16" DIA (406.4mm)	1040

Stainless Steel

Hexagon Bar

Stainless Steel Hexagon Bar Grade 1.4305 (303)

Size	KG/Metre
0.3125" A/F	0.43
0.437" A/F	0.84
0.500" A/F	1.10
0.562" A/F	1.39
0.625" A/F	1.73
0.750" A/F	2.48
0.820" A/F	2.97
0.875" A/F	3.38
0.937" A/F	3.88
1.010" A/F	4.50
1.125" A/F	5.59
1.250" A/F	6.90



Stainless Steel Hexagon Bar Grade 1.4404 (316L)

Size	KG/Metre
0.500" A/F	1.11
0.562" A/F	1.40
0.625" A/F	1.74
17.0mm A/F	1.99
0.750" A/F	2.50
0.820" A/F	2.99
0.875" A/F	3.41
0.920" A/F	3.76
1.010" A/F	4.54
1.101" A/F	5.39
1.125" A/F	5.63
1.200" A/F	6.40
1.250" A/F	6.95
1.300" A/F	7.52
1.375" A/F	8.41
1.480" A/F	9.74
1.500" A/F	10.0
1.670" A/F	12.4
1.860" A/F	15.4
2.500" A/F	27.8

Square Bar

Stainless Steel Hot Rolled Square Bar Grade 1.4307/304L

Size	KG/Metre
12.0mm SQ	1.14
16.0mm SQ	2.02
20.0mm SQ	3.16
25.0mm SQ	4.94
30.0mm SQ	7.11
40.0mm SQ	12.64
50.0mm SQ	19.75



Stainless Steel Hot Rolled Square Bar Grade 1.4404/316L

Size	KG/Metre
12.0mm SQ	1.15
16.0mm SQ	2.04
20.0mm SQ	3.18
25.0mm SQ	4.98
30.0mm SQ	7.16
1½" SQ	11.55
40.0mm SQ	12.74
50.0mm SQ	19.90

Stainless Steel

Flat Bar - Hot Rolled



Stainless Steel Hot Rolled Flat Bar Grade 1.4307
(304L)

Size	KG/Metre
20.0mm X 10.0mm	1.58
20.0mm X 12.0mm	1.90
25.0mm X 10.0mm	1.98
25.0mm X 12.0mm	2.37
25.0mm X 15.0mm	2.96
25.0mm X 20.0mm	3.95
30.0mm X 12.0mm	2.84
30.0mm X 15.0mm	3.56
30.0mm X 25.0mm	5.93
40.0mm X 15.0mm	4.74
40.0mm X 20.0mm	6.32
40.0mm X 25.0mm	7.90
50.0mm X 15.0mm	5.93
50.0mm X 20.0mm	7.90
50.0mm X 25.0mm	9.88
60.0mm X 15.0mm	7.11
60.0mm X 20.0mm	9.48
60.0mm X 25.0mm	11.9
75.0mm X 15.0mm	8.89
75.0mm X 20.0mm	11.9
75.0mm X 25.0mm	14.8
100.0mm X 15.0mm	11.9
100.0mm X 20.0mm	15.8
100.0mm X 25.0mm	19.8

Stainless Steel Hot Rolled Flat Bar Grade 1.4404
(316L)

Size	KG/Metre
20.0mm X 10.0mm	1.59
20.0mm X 12.0mm	1.91
25.0mm X 10.0mm	1.99
25.0mm X 12.0mm	2.39
25.0mm X 15.0mm	2.99
30.0mm X 12.0mm	2.87
30.0mm X 20.0mm	4.78
30.0mm X 25.0mm	5.97
40.0mm X 15.0mm	4.78
40.0mm X 20.0mm	6.37
40.0mm X 25.0mm	7.96
50.0mm X 15.0mm	5.97
50.0mm X 20.0mm	7.96
50.0mm X 25.0mm	9.95
60.0mm X 15.0mm	7.16
60.0mm X 20.0mm	9.55
75.0mm X 20.0mm	11.94
100.0mm X 15.0mm	11.94

Stainless Steel

Flat Bar - Rolled Edge

Stainless Steel Rolled Edge Flat Bar Grades 1.4307 (304L) & 1.4404 (316L)



Size	KG/Metre
12.0mm X 3.0mm	0.28
12.0mm X 5.0mm	0.47
12.0mm X 6.0mm	0.57
20.0mm X 3.0mm	0.47
20.0mm X 5.0mm	0.79
20.0mm X 6.0mm	0.95
25.0mm X 3.0mm	0.59
25.0mm X 5.0mm	0.99
25.0mm X 6.0mm	1.19
25.0mm X 8.0mm	1.58
25.0mm X 10.0mm	1.98
30.0mm X 3.0mm	0.71
30.0mm X 5.0mm	1.19
30.0mm X 6.0mm	1.42
30.0mm X 8.0mm	1.90
30.0mm X 10.0mm	2.37
35.0mm X 6.0mm	1.66
40.0mm X 3.0mm	0.95
40.0mm X 5.0mm	1.58
40.0mm X 6.0mm	1.90
40.0mm X 8.0mm	2.53
40.0mm X 10.0mm	3.16
40.0mm X 12.0mm	3.79
45.0mm X 6.0mm	2.13
50.0mm X 3.0mm	1.19
50.0mm X 5.0mm	1.98
50.0mm X 6.0mm	2.37

continued...

Size	KG/Metre
50.0mm X 8.0mm	3.16
50.0mm X 10.0mm	3.95
50.0mm X 12.0mm	4.74
60.0mm X 3.0mm	1.42
60.0mm X 5.0mm	2.37
60.0mm X 6.0mm	2.84
60.0mm X 8.0mm	3.79
60.0mm X 10.0mm	4.74
60.0mm X 12.0mm	5.69
65.0mm X 6.0mm	3.08
65.0mm X 10.0mm	5.14
75.0mm X 3.0mm	1.78
75.0mm X 5.0mm	2.96
75.0mm X 6.0mm	3.56
75.0mm X 8.0mm	4.74
75.0mm X 10.0mm	5.93
75.0mm X 12.0mm	7.11
80.0mm X 6.0mm	3.79
80.0mm X 10.0mm	6.32
100.0mm X 3.0mm	2.37
100.0mm X 5.0mm	3.95
100.0mm X 6.0mm	4.74
100.0mm X 8.0mm	6.32
100.0mm X 10.0mm	7.90
100.0mm X 12.0mm	9.48
125.0mm X 6.0mm	5.93
125.0mm X 10.0mm	9.88

continued...

Size	KG/Metre
125.0mm X 12.0mm	11.85
150.0mm X 6.0mm	7.11
150.0mm X 8.0mm	9.48
150.0mm X 10.0mm	11.85
150.0mm X 12.0mm	14.33
200.0mm X 6.0mm	9.48
200.0mm X 8.0mm	12.64
200.0mm X 10.0mm	15.80

Stainless Steel

Structural & Decorative Tube - Round

Stainless Steel Welded Structural & Decorative Tube
Grades 304 & 316 - Mirror Polish O/D

Size	KG/Metre
5/8" OD X 1.2mm	0.44
5/8" OD X 1.5mm	0.54
1/2" OD X 1.5mm	0.42
3/4" OD X 18SWG	0.54
3/4" OD X 1.5mm	0.65
7/8" OD X 1.2mm	0.63
7/8" OD X 1.5mm	0.77
7/8" OD X 2.0mm	1.00
19mm OD X 1.2mm	0.53
1" OD X 1.2mm	0.72
1" OD X 1.5mm	0.89
1" OD X 2.0mm	1.17
1 1/4" OD X 1.2mm	0.91
1 1/4" OD X 1.5mm	1.13
1 1/2" OD X 1.2mm	1.10
1 1/2" OD X 1.5mm	1.40
1 1/2" OD X 2.0mm	1.80
1 3/4" OD X 1.5mm	1.60
2" OD X 1.2mm	1.48
2" OD X 1.5mm	1.84
2" OD X 2.0mm	2.44
2" OD X 3.0mm	3.56
2 1/2" OD X 1.5mm	2.31
3" OD X 1.5mm	2.78

Stainless Steel Welded Structural & Decorative Tube
Grades 304 & 316 - Brushed Finish O/D

Size	KG/Metre
3/4" OD X 1.5mm	0.65
1" OD X 1.5mm	0.89
1 1/2" OD X 1.5mm	1.36
1 1/2" OD X 2.0mm	1.79
1 1/2" OD X 3.0mm	2.61
2" OD X 1.5mm	1.84
2" OD X 2.0mm	2.42
2" OD X 3.0mm	3.56
3" OD X 3.0mm	5.45
4" OD X 3.0mm	7.34

Stainless Steel Welded Structural & Decorative Tube
ASTM A554 Grades 304 & 316 - Satin Polish O/D

Size	KG/Metre
1 1/2" OD X 3.0mm SATIN	2.63
2" OD X 3.0mm SATIN	3.59
3" OD X 3.0mm SATIN	5.49
4" OD X 3.0mm SATIN	7.40

Stainless Steel Welded Structural & Decorative Tube
Grades 304 & 316 - Dull Polish O/D

Size	KG/Metre
3/4" OD X 1.5mm	0.65
1" OD X 1.5mm	0.89
1 1/2" OD X 1.5mm	1.36
1 1/2" OD X 2.0mm	1.79
1 1/2" OD X 3.0mm	2.61
2" OD X 1.5mm	1.84
2" OD X 2.0mm	2.42
2" OD X 3.0mm	3.56
3" OD X 3.0mm	5.45
4" OD X 3.0mm	7.34

Stainless Steel Welded Structural & Decorative Tube
Grade 304 - Descaled Finish

Size	KG/Metre
25mm OD X 1.5mm	0.90
25mm OD X 2.0mm	1.14



Stainless Steel

Structural & Decorative Tube - Square

Stainless Steel Welded Structural & Decorative Tube
Grade 1.4301 (304) - Dull Polish O/D

Size	KG/Metre
12.7mm X 12.7mm X 1.2mm	0.45
12.7mm X 12.7mm X 1.5mm	0.55
15mm X 15mm X 1.2mm	0.53
15mm X 15mm X 1.5mm	0.66
20mm X 20mm X 1.2mm	0.72
20mm X 20mm X 1.5mm	0.88
20mm X 20mm X 2.0mm	1.19
25mm X 25mm X 1.2mm	0.93
25mm X 25mm X 1.5mm	1.15
25mm X 25mm X 2.0mm	1.50
25mm X 25mm X 3.0mm	2.21
30mm X 30mm X 1.2mm	1.11
30mm X 30mm X 1.5mm	1.37
30mm X 30mm X 2.0mm	1.84
30mm X 30mm X 3.0mm	2.72
40mm X 40mm X 1.2mm	1.50
40mm X 40mm X 1.5mm	1.86
40mm X 40mm X 2.0mm	2.45
40mm X 40mm X 3.0mm	3.76
50mm X 50mm X 1.5mm	2.33
50mm X 50mm X 2.0mm	3.08
50mm X 50mm X 3.0mm	4.65
60mm X 60mm X 2.0mm	3.71
60mm X 60mm X 3.0mm	5.49
70mm X 70mm X 3.0mm	6.53
80mm X 80mm X 2.0mm	4.99

Size	KG/Metre
80mm X 80mm X 3.0mm	7.53
100mm X 100mm X 2.0mm	6.40
100mm X 100mm X 3.0mm	9.53

Stainless Steel Welded Structural & Decorative Tube
Grade 1.4301 (304) - Descaled Finish

Size	KG/Metre
12.7mm X 12.7mm X 1.2mm	0.45
12.7mm X 12.7mm X 1.5mm	0.55
40mm X 40mm X 4.0mm	4.81
50mm X 50mm X 4.0mm	5.96
50mm X 50mm X 5.0mm	7.41
60mm X 60mm X 4.0mm	7.22
60mm X 60mm X 5.0mm	8.90
80mm X 80mm X 4.0mm	9.82
80mm X 80mm X 5.0mm	12.40
100mm X 100mm X 4.0mm	12.40
100mm X 100mm X 5.0mm	15.38
100mm X 100mm X 6.0mm	17.50
100mm X 100mm X 8.0mm	23.26
120mm X 120mm X 3.0mm	11.80
120mm X 120mm X 4.0mm	15.00
120mm X 120mm X 5.0mm	18.66
120mm X 120mm X 6.0mm	21.20
150mm X 150mm X 3.0mm	14.06



Stainless Steel Welded Structural & Decorative Tube
Grade 1.4301 (304) - Brushed Finish O/D

Size	KG/Metre
150mm X 150mm X 4.0mm	18.62
150mm X 150mm X 5.0mm	22.40
150mm X 150mm X 6.0mm	27.36
150mm X 150mm X 8.0mm	34.30
150mm X 150mm X 10.0mm	41.65
200mm X 200mm X 3.0mm	18.62
200mm X 200mm X 5.0mm	30.40
200mm X 200mm X 6.0mm	36.09
200mm X 200mm X 8.0mm	47.10
200mm X 200mm X 10.0mm	57.60

Stainless Steel Welded Structural & Decorative Tube
Grade 1.4404 (316) - Descaled Finish

Size	KG/Metre
80mm X 80mm X 4.0mm	9.82
100mm X 100mm X 4.0mm	12.40
100mm X 100mm X 5.0mm	15.38
100mm X 100mm X 6.0mm	17.50
100mm X 100mm X 8.0mm	21.60
120mm X 120mm X 4.0mm	14.77
120mm X 120mm X 5.0mm	18.66
120mm X 120mm X 6.0mm	21.20
150mm X 150mm X 4.0mm	18.60
150mm X 150mm X 5.0mm	23.08
150mm X 150mm X 6.0mm	27.51

continued...

Stainless Steel

Structural & Decorative Tube - Square

Stainless Steel Welded Structural & Decorative Tube
Grade 1.4016 (316) - Dull Polish O/D

Size	KG/Metre
20mm X 20mm X 1.5mm	0.88
25mm X 25mm X 1.5mm	1.15
25mm X 25mm X 2.0mm	1.50
30mm X 30mm X 1.5mm	1.37
30mm X 30mm X 2.0mm	1.84
30mm X 30mm X 3.0mm	2.72
40mm X 40mm X 1.5mm	1.86
40mm X 40mm X 2.0mm	2.45
40mm X 40mm X 3.0mm	3.76
50mm X 50mm X 1.5mm	2.33
50mm X 50mm X 2.0mm	3.08
50mm X 50mm X 3.0mm	4.65
60mm X 60mm X 3.0mm	5.44
80mm X 80mm X 3.0mm	7.36
100mm X 100mm X 3.0mm	9.53
100mm X 100mm X 4.0mm	12.40

Stainless Steel Welded Structural & Decorative Tube
Grade 1.4016 (430) - Dull Polish O/D

Size	KG/Metre
25mm X 25mm X 1.2mm	0.93
30mm X 30mm X 1.2mm	1.11
30mm X 30mm X 1.5mm	1.37
40mm X 40mm X 1.5mm	1.86

Stainless Steel Welded Structural & Decorative Tube
Grade 1.4301 (304) - Brushed Finish O/D

Size	KG/Metre
20mm X 20mm X 1.5mm	0.88



Stainless Steel Welded Structural & Decorative Tube
to EN/ISO 1127 Grade 1.4509 (441) - Dull Polish O/D

Size	KG/Metre
25mm X 25mm X 1.2mm	0.93
30mm X 30mm X 1.2mm	1.11
30mm X 30mm X 1.5mm	1.37
40mm X 40mm X 1.5mm	1.86

Stainless Steel

Structural & Decorative Tube - Rectangular



Stainless Steel Welded Structural & Decorative Tube
Grade 304 - Descaled Finish

Size	KG/Metre
80mm X 40mm X 4.0mm	7.22
80mm X 40mm X 5.0mm	8.90
100mm X 50mm X 4.0mm	9.09
100mm X 50mm X 5.0mm	11.2
120mm X 60mm X 3.0mm	8.39
120mm X 60mm X 4.0mm	11.1
120mm X 60mm X 5.0mm	13.8
120mm X 80mm X 3.0mm	9.53
120mm X 80mm X 4.0mm	12.4
120mm X 80mm X 5.0mm	15.4
150mm X 50mm X 3.0mm	9.53
150mm X 50mm X 5.0mm	15.4
150mm X 100mm X 3.0mm	11.7
150mm X 100mm X 4.0mm	15.4
150mm X 100mm X 5.0mm	18.8
150mm X 100mm X 6.0mm	22.6
150mm X 100mm X 8.0mm	27.9
200mm X 100mm X 3.0mm	14.1
200mm X 100mm X 4.0mm	18.6
200mm X 100mm X 5.0mm	22.4
200mm X 100mm X 6.0mm	27.4
200mm X 100mm X 8.0mm	35.9
200mm X 100mm X 10.0mm	41.6
250mm X 150mm X 6.0mm	36.8
250mm X 150mm X 8.0mm	47.3

Stainless Steel Welded Structural & Decorative Tube
Grade 304 - Dull Polish O/D

Size	KG/Metre
20mm X 10mm X 1.5mm	0.66
30mm X 10mm X 1.2mm	0.73
30mm X 10mm X 1.5mm	0.90
30mm X 15mm X 1.5mm	1.00
30mm X 20mm X 1.5mm	1.15
40mm X 15mm X 1.5mm	1.26
40mm X 20mm X 1.2mm	1.11
40mm X 20mm X 1.5mm	1.37
40mm X 20mm X 2.0mm	1.84
50mm X 25mm X 1.2mm	1.42
50mm X 25mm X 1.5mm	1.76
50mm X 25mm X 2.0mm	2.32
50mm X 25mm X 3.0mm	3.46
50mm X 30mm X 1.5mm	1.86
50mm X 30mm X 2.0mm	2.45
50mm X 30mm X 3.0mm	3.76
60mm X 20mm X 1.5mm	1.86
60mm X 30mm X 1.5mm	2.12
60mm X 30mm X 2.0mm	2.80
60mm X 30mm X 3.0mm	4.13
60mm X 40mm X 1.5mm	2.33
60mm X 40mm X 2.0mm	3.08
60mm X 40mm X 3.0mm	4.65
80mm X 40mm X 1.5mm	2.80
80mm X 40mm X 2.0mm	3.71
80mm X 40mm X 3.0mm	5.49

Size	KG/Metre
80mm X 60mm X 3.0mm	6.53
100mm X 50mm X 2.0mm	4.68
100mm X 40mm X 3.0mm	6.53
100mm X 50mm X 3.0mm	6.95
100mm X 60mm X 3.0mm	7.53
120mm X 60mm X 3.0mm	8.39

continued...

Stainless Steel

Structural & Decorative Tube - Rectangular

Stainless Steel Welded Structural & Decorative Tube
Grade 316 - Descaled finish

Size	KG/Metre
80mm X 40mm X 4.0mm	7.2
80mm X 40mm X 5.0mm	8.9
100mm X 50mm X 5.0mm	11.1
120mm X 80mm X 3.0mm	9.5
120mm X 80mm X 5.0mm	15.4
150mm X 100mm X 3.0mm	11.7
150mm X 100mm X 4.0mm	15.4
150mm X 100mm X 5.0mm	19.1
150mm X 100mm X 6.0mm	22.6
150mm X 100mm X 8.0mm	29.8
200mm X 100mm X 4.0mm	18.6
200mm X 100mm X 5.0mm	23.1
200mm X 100mm X 6.0mm	27.5
200mm X 100mm X 8.0mm	34.3

Stainless Steel Welded Structural & Decorative Tube
Grade 316 - Dull Polish O/D

Size	KG/Metre
40mm X 20mm X 1.5mm	1.37
50mm X 25mm X 1.5mm	1.76
60mm X 40mm X 2.0mm	3.06
80mm X 40mm X 2.0mm	3.71
80mm X 40mm X 3.0mm	5.49
100mm X 50mm X 2.0mm	4.68
100mm X 50mm X 3.0mm	6.95



Stainless Steel

Pipe

SEAMLESS TO ASTM A312 / ANSI B36.19

Size	304L	316L
1/8" SCH10S		0.28
1/8" SCH40S		0.37
1/4" SCH10S		0.50
1/4" SCH40S	0.64	0.64
1/4" SCH80S	0.81	0.81
3/8" SCH10S	0.64	0.64
3/8" SCH40S	0.86	0.86
3/8" SCH80S		1.12
1/2" SCH10S	1.02	1.02
1/2" SCH40S	1.29	1.29
1/2" SCH80S	1.65	1.65
3/4" SCH10S		1.30
3/4" SCH40S	1.72	1.72
3/4" SCH80S	2.24	2.24
1" SCH10S	2.13	2.13
1" SCH40S	2.55	2.55
1" SCH80S	3.30	3.30
1 1/4" SCH40S	3.45	
1 1/4" SCH80S	4.55	4.55
1 1/2" SCH5S	1.93	
1 1/2" SCH10S	3.16	3.16
1 1/2" SCH40S	4.12	4.12
1 1/2" SCH80S	5.51	5.51
2" SCH10S	4.00	4.00
2" SCH40S	5.54	5.54
2" SCH80S	7.62	7.62

continued...

Size	304L	316L
2 1/2" SCH10S	5.36	5.36
2 1/2" SCH40S	8.79	8.79
2 1/2" SCH80S		11.60
3" SCH10S	6.57	6.57
3" SCH40S	11.50	11.50
3" SCH80S	15.60	15.60
4" SCH10S	8.52	8.52
4" SCH40S	16.40	16.40
4" SCH80S	22.70	22.70
5" SCH40S		22.20
6" SCH10S	14.10	
6" SCH40S	28.80	
6" SCH80S	43.40	43.40
8" SCH10S		20.30
8" SCH40S	43.30	43.30

SEAMLESS TO ASTM A312 / ANSI B36.10 Grade 316L



Size	KG/Metre
1/2" SCH160	1.99
3/4" SCH160	2.95
1" SCH160	4.32
1 1/2" SCH160	7.37
2" SCH160	11.30
3" SCH160	21.70
6" SCH10S	14.10
6" SCH40S	28.80
8" SCH80S	65.90

Stainless Steel

Pipe

WELDED TO ASTM A312 / ANSI B36.19



Size	304L	316L
½" SCH5S	0.82	0.82
½" SCH10S	1.02	1.02
½" SCH40S	1.29	1.29
¾" SCH5S	1.04	1.04
¾" SCH10S	1.30	1.30
¾" SCH40S	1.72	1.72
1" SCH5S	1.32	1.32
1" SCH10S	2.13	2.13
1" SCH40S	2.55	2.55
1¼" SCH5S	1.68	
1¼" SCH10S	2.74	2.74
1¼" SCH40S	3.45	3.45
1½" SCH5S		1.93
1½" SCH10S	3.16	3.16
1½" SCH40S	4.11	4.11
2" SCH5S	2.43	2.43
2" SCH10S	4.00	4.00
2" SCH40S	5.54	5.54
2½" SCH5S	3.76	3.76
2½" SCH10S	5.36	5.36
2½" SCH40S	8.79	8.79
3" SCH5S	4.60	4.60
3" SCH10S	6.57	6.57
3" SCH40S	11.50	11.50
3½" SCH10S	7.55	7.55
3½" SCH40S	13.80	13.80

Size	304L	316L
4" SCH5S	5.94	5.94
4" SCH10S	8.52	8.52
4" SCH40S	16.40	16.40
5" SCH10S	11.80	11.80
5" SCH40S	22.20	22.20
6" SCH5S	11.50	11.50
6" SCH10S	14.10	14.10
6" SCH40S	28.80	28.80
8" SCH5S	15.10	15.10
8" SCH10S	20.30	20.30
8" SCH40S	43.30	43.30
10" SCH5S		23.10
10" SCH10S	28.30	28.30
10" SCH40S	61.40	61.40
12" SCH5S		31.90
12" SCH10S	36.70	36.70
12" SCH40S	75.20	75.20
14" SCH10S	42.10	42.10
16" SCH10S	48.20	48.20
18" SCH10S	54.30	54.30
20" SCH10S	69.90	69.90
24" SCH10S	96.20	96.20

continued...

Stainless Steel

Butt Weld Fittings



Stainless Steel Equal Tees - Seamless

Size	304L	316L
½" SCH10S EQUAL TEE		0.06
½" SCH40S EQUAL TEE	0.07	0.07
1" SCH10S EQUAL TEE	0.18	0.18
1" SCH40S EQUAL TEE	0.21	0.21
1½" SCH10S EQUAL TEE	0.40	0.40
1½" SCH40S EQUAL TEE		0.52
2" SCH10S EQUAL TEE	0.56	0.56
2" SCH40S EQUAL TEE	0.77	0.77
3" SCH10S EQUAL TEE		1.24
3" SCH40S EQUAL TEE		2.17
4" SCH10S EQUAL TEE	1.96	1.96
4" SCH80S EQUAL TEE		5.24
6" SCH10S EQUAL TEE	4.43	4.43

Stainless Steel Reducing Tees - Seamless

Size	304L	316L
1"-½" SCH10S RED TEE	0.18	0.18
1½"-1" SCH40S RED TEE		0.52
2"-1" SCH10S RED TEE		0.56
2"-1" SCH40S RED TEE		0.77
1½"-½" SCH10S RED TEE		0.65
1½"-¾" SCH10S RED TEE		0.14
3"-2" SCH10S RED TEE		1.24
4"-2" SCH10S RED TEE	1.96	

Stainless Steel Long Radius Elbows - 90 Degree - Seamless

Size	304L	316L
½" SCH10S 90 LR ELBOW	0.06	0.06
½" SCH40S 90 LR ELBOW	0.08	0.08
1" SCH80S 90 LR ELBOW		0.10
¾" SCH10S 90 LR ELBOW	0.06	0.06
¾" SCH40S 90 LR ELBOW		0.08
¾" SCH80S 90 LR ELBOW		0.10
1" SCH10S 90 LR ELBOW	0.13	0.13
1" SCH40S 90 LR ELBOW	0.15	0.15
1" SCH80S 90 LR ELBOW		0.20
1½" SCH10S 90 LR ELBOW	0.28	0.28
1½" SCH40S 90 LR ELBOW	0.37	0.37
1½" SCH80S 90 LR ELBOW		0.49
2" SCH10S 90 LR ELBOW	0.48	0.48
2" SCH40S 90 LR ELBOW	0.66	0.66
2" SCH80S 90 LR ELBOW		0.91
2½" SCH10S 90 LR ELBOW	0.80	0.80
3" SCH10S 90 LR ELBOW	1.18	1.18
3" SCH40S 90 LR ELBOW	2.07	2.07
4" SCH10S 90 LR ELBOW	2.04	2.04
4" SCH40S 90 LR ELBOW	3.92	3.92
6" SCH10S 90 LR ELBOW	5.06	5.06
6" SCH40S 90 LR ELBOW		10.35
8" SCH10S 90 LR ELBOW	9.74	

Stainless Steel Long Radius 45 Degree Elbows - Seamless

Size	304L	316L
½" SCH40S 45 LR ELBOW		0.04
1" SCH10S 45 LR ELBOW		0.06
1½" SCH10S 45 LR ELBOW		0.14
1½" SCH40S 45 LR ELBOW		0.18
2" SCH10S 45 LR ELBOW		0.24
2" SCH40S 45 LR ELBOW		0.33



Stainless Steel End Caps - Seamless

Size	304L	316L
½" SCH10S END CAP		0.03
1" SCH10S END CAP	0.07	0.07
1" SCH40S END CAP		0.10
1¼" SCH10S END CAP		0.10
1½" SCH10S END CAP	0.13	0.13
2" SCH10S END CAP	0.19	0.19
2½" SCH40S END CAP	0.37	
3" SCH10S END CAP	0.38	0.38
3" SCH40S END CAP		0.64
4" SCH10S END CAP	0.57	0.57
6" SCH10S END CAP		1.41
8" SCH40S END CAP		5.08
12" SCH10S END CAP		6.68

Stainless Steel

Butt Weld Fittings



Stainless Steel Concentric Reducers - Seamless

Size	304L	316L
1"-½" 40S CON-RED		0.13
1"-½" 10S CON-RED		0.11
1½"-1" 10S CON-RED	0.20	0.20
1½"-1" 40S CON-RED		0.26
1½"-1¼" 40S CON-RED		0.26
2"-1" 10S CON-RED	0.30	0.30
2"-1" 40S CON-RED	0.42	0.42
2"-1½" 10S CON-RED		0.30
2"-1½" 40S CON-RED		0.42
3"-1½" 40S CON-RED		1.02
3"-2" 10S CON-RED		0.58
3"-2" 40S CON-RED		1.02
4"-2" 10S CON-RED	0.87	0.87
4"-2" 40S CON-RED		1.66
4"-3" 10S CON-RED	0.87	0.87
6"-3" 10S CON-RED		1.97
6"-4" 10S CON-RED		1.97

Stainless Steel Eccentric Reducers - Seamless

Size	304L	316L
1¼"-1" 10S ECC-RED		0.18
4"-3" 10S ECC-RED		0.87



Stainless Steel Short Radius Elbows - 90 Degree-
Seamless (ANSI B16.28)

1½"SCH40S 90 SR ELBOW	0.25
2" SCH10S 90 SR ELBOW	0.32
2" SCH40S 90 SR ELBOW	0.44
3" SCH10S 90 SR ELBOW	0.79
3" SCH40S 90 SR ELBOW	1.38
4" SCH10S 90 SR ELBOW	1.36
4" SCH40S 90 SR ELBOW	
6" SCH10S 90 SR ELBOW	5.45



Stainless Steel Stub Ends Type A MSS SP43 Seamless

Size	304L	316L
1" 10S STUB TYPE A		0.14
1½" 10S STUB TYPE A		0.25
2" 10S STUB TYPE A	0.38	0.38
3" 10S STUB TYPE A		0.64
4" 10S STUB TYPE A		0.98
6" 10S STUB TYPE A		1.95

Stainless Steel

Butt Weld Fittings



Stainless Steel Equal Tees - Welded

Size	304L	316L
½" SCH10S EQUAL TEE	0.06	0.06
¾" SCH10S EQUAL TEE	0.08	0.08
1" SCH10S EQUAL TEE	0.18	0.18
1" SCH40S EQUAL TEE	0.21	0.21
1½" SCH10S EQUAL TEE	0.40	0.40
1½" SCH40S EQUAL TEE	0.52	0.52
2" SCH10S EQUAL TEE	0.56	0.56
2" SCH40S EQUAL TEE	0.77	0.77
3" SCH10S EQUAL TEE	1.24	1.24
4" SCH10S EQUAL TEE	1.96	1.96
6" SCH10S EQUAL TEE	4.43	

Stainless Steel Reducing Tees - Welded

Size	304L	316L
1"-½" SCH10S RED TEE		0.18
1½"-1" SCH10S RED TEE	0.40	0.40
2"-1" SCH10S RED TEE	0.56	0.56
2"-1½" SCH10S RED TEE	0.56	
3"-1½" SCH10S RED TEE	1.24	
3"-2" SCH10S RED TEE	1.24	1.24



Stainless Steel Long Radius 90 Degree Elbows - Welded

Size	304L	316L
½" SCH10S 90 LR ELBOW	0.06	0.06
½" SCH40S 90 LR ELBOW	0.08	0.08
¾" SCH10S 90 LR ELBOW	0.06	0.06
¾" SCH40S 90 LR ELBOW	0.08	0.08
1" SCH10S 90 LR ELBOW	0.13	0.13
1" SCH40S 90 LR ELBOW	0.15	0.15
1¼" SCH10S 90 LR ELBOW	0.21	0.21
1¼" SCH40S 90 LR ELBOW	0.26	
1½" SCH10S 90 LR ELBOW	0.28	0.28
1½" SCH40S 90 LR ELBOW		0.37
2" SCH10S 90 LR ELBOW	0.48	0.48
2" SCH40S 90 LR ELBOW	0.66	0.66
2½" SCH10S 90 LR ELBOW	0.80	0.80
3" SCH10S 90 LR ELBOW	1.18	1.18
3" SCH40S 90 LR ELBOW	2.07	2.07
4" SCH10S 90 LR ELBOW	2.04	2.04
4" SCH40S 90 LR ELBOW	3.92	3.92
6" SCH10S 90 LR ELBOW	5.06	5.06
6" SCH40S 90 LR ELBOW	10.35	10.35
8" SCH10S 90 LR ELBOW	9.74	9.74
8" SCH40S 90 LR ELBOW		20.76
10" SCH10S 90 LR ELBOW	16.95	16.95
12" SCH10S 90 LR ELBOW	26.35	26.35
12" SCH40S 90 LR ELBOW		54.04
14" SCH10S 90 LR ELBOW		35.28
16" SCH10S 90 LR ELBOW		46.10
20" SCH10S 90 LR ELBOW		83.70



Stainless Steel Long Radius 45 Degree Elbows - Welded

Size	304L	316L
¾" SCH40S 45 LR ELBOW	0.03	0.04
1" SCH10S 45 LR ELBOW		0.60
1" SCH40S 45 LR ELBOW		0.08
1½" SCH10S 45 LR ELBOW	0.14	0.14
1½" SCH40S 45 LR ELBOW		0.18
2" SCH10S 45 LR ELBOW	0.24	0.24
3" SCH10S 45 LR ELBOW	0.59	0.59
4" SCH10S 45 LR ELBOW	1.02	1.02
6" SCH10S 45 LR ELBOW	2.53	2.53
8" SCH10S 45 LR ELBOW		4.87
10" SCH10S 45 LR ELBOW		8.47

Stainless Steel

Butt Weld Fittings

Stainless Steel Concentric Reducers - Welded

Size	304L	316L
1"-½" 10S CON-RED	0.11	0.11
1"-½" 40S CON-RED		0.13
1"-¾" 10S CON-RED		0.11
1½"-1" 10S CON-RED	0.20	0.20
1½"-1" 40S CON-RED		0.26
2"-1" 10S CON-RED	0.30	0.30
2"-1½" 10S CON-RED	0.30	0.30
2"-1½" 40S CON-RED	0.42	0.42
2½"-2" 10S CON-RED		0.48
3"-1½" 10S CON-RED	0.58	0.58
3"-2" 10S CON-RED	0.58	0.58
3"-2" 40S CON-RED		1.02
3"-2½" 10S CON-RED		0.58
4"-2" 10S CON-RED	0.87	0.87
4"-3" 10S CON-RED	0.87	0.87
6"-3" 10S CON-RED	1.97	
6"-4" 10S CON-RED	1.97	1.97
8"-4" 10S CON-RED		3.10
8"-6" 10S CON-RED		3.10



Stainless Steel Eccentric Reducers - Welded

Size	304L	316L
1½"-1" 10S ECC-RED		0.20
1½"-1" 40S ECC-RED		0.26
2½"-2" 10S ECC-RED		0.48
3"-1½" 10S ECC-RED		0.58
3"-2" 10S ECC-RED	0.58	
4"-2" 10S ECC-RED		0.87
4"-3" 10S ECC-RED		0.87



Stainless Steel Stub Ends Type A MSS SP43 Welded

Size	304L	316L
½" 10S STUB TYPE A		0.08
1" 10S STUB TYPE A	0.14	0.14
1½" 10S STUB TYPE A	0.25	0.25
2" 10S STUB TYPE A	0.38	0.38
2½" 10S STUB TYPE A		0.47
3" 10S STUB TYPE A		0.64
4" 10S STUB TYPE A		0.98
6" 10S STUB TYPE A		1.95
8" 10S STUB TYPE A		3.11

Stainless Steel Flanges



Stainless Steel Raised Face Slip On Flanges ASTM A182/ANSI B16.5 150lb Grades 304L & 316L

Size	KG/Unit
½" 150lb RF BLIND	0.42
¾" 150lb RF BLIND	0.61
1" 150lb RF BLIND	0.86
1½" 150lb RF BLIND	1.53
2" 150lb RF BLIND	2.42
2½" 150lb RF BLIND	3.94
3" 150lb RF BLIND	4.93
4" 150lb RF BLIND	7.00
6" 150lb RF BLIND	11.3
8" 150lb RF BLIND	19.6
10" 150lb RF BLIND	28.8
12" 150lb RF BLIND	43.2

Stainless Steel Raised Face Blind Flanges ASTM A182/ANSI B16.5 300lb Grade 316

Size	KG/Unit
¾" 300lb RF BLIND	1.11
1" 300lb RF BLIND	1.39
2" 300lb RF BLIND	3.18
3" 300lb RF BLIND	6.81
4" 300lb RF BLIND	11.50

Size	KG/Unit
½" 150lb RF SLIP ON	0.39
¾" 150lb RF SLIP ON	0.56
1" 150lb RF SLIP ON	0.78
1¼" 150lb RF SLIP ON	1.03
1½" 150lb RF SLIP ON	1.32
2" 150lb RF SLIP ON	2.06
2½" 150lb RF SLIP ON	3.28
3" 150lb RF SLIP ON	3.85
4" 150lb RF SLIP ON	5.30
5" 150lb RF SLIP ON	6.01
6" 150lb RF SLIP ON	7.45
8" 150lb RF SLIP ON	12.1
10" 150lb RF SLIP ON	16.5
12" 150lb RF SLIP ON	26.2
14" 150lb RF SLIP ON	34.6
16" 150lb RF SLIP ON	44.8

Stainless Steel Raised Face Slip On Flanges ASTM A182/ANSI B16.5 300lb Grade 316

Size	KG/Unit
1" 300lb RF SLIP ON	1.36
1½" 300lb RF SLIP ON	2.49
2" 300lb RF SLIP ON	2.87
3" 300lb RF SLIP ON	5.85
4" 300lb RF SLIP ON	9.61

Size	KG/Unit
½" 150lb RFWN SCH10S	0.48
½" 150lb RFWN SCH40S	0.48
¾" 150lb RFWN SCH40S	0.71
1" 150lb RFWN SCH10S	1.01
1" 150lb RFWN SCH40S	1.01
1½" 150lb RFWN SCH10S	1.72
1½" 150lb RFWN SCH40S	1.72
2" 150lb RFWN SCH10S	2.58
2" 150lb RFWN SCH40S	2.58
2½" 150lb RFWN SCH10S	4.11
2½" 150lb RFWN SCH40S	4.11
3" 150lb RFWN SCH10S	4.92
3" 150lb RFWN SCH40S	4.92
4" 150lb RFWN SCH10S	6.84
4" 150lb RFWN SCH40S	6.84
6" 150lb RFWN SCH10S	10.6
6" 150lb RFWN SCH40S	10.6
8" 150lb RFWN SCH10S	17.6
10" 150lb RFWN SCH10S	24.0
12" 150lb RFWN SCH10S	24.0

Stainless Steel

Flanges

Stainless Steel Raised Face Weld Neck Flanges ASTM A182/ANSI B16.5 300lb Grade 316

Size	KG/Unit
¾" 300lb RFWN SCH40S	1.26
1" 300lb RFWN SCH10S	1.52
1" 300lb RFWN SCH40S	1.52
2" 300lb RFWN SCH10S	3.40
2" 300lb RFWN SCH40S	3.40
3" 300lb RFWN SCH10S	4.92
3" 300lb RFWN SCH40S	6.93
4" 300lb RFWN SCH40S	11.20

Stainless Steel Plate Flanges BS10 Table E - Blind Grade 316L

Size	KG/Unit
1" NB TABLE E BLIND	0.52
1½" TABLE E BLIND	0.88
2" TABLE E BLIND	1.26
3" TABLE E BLIND	2.23
4" TABLE E BLIND	3.45
6" TABLE E BLIND	5.14

Stainless Steel Plate Flanges BS10 Table E - Slip On Grade 316L

Size	KG/Unit
½" TABLE E SLIP ON	0.30
¾" TABLE E SLIP ON	0.33
1" TABLE E SLIP ON	0.47
1½" TABLE E SLIP ON	0.75
2" TABLE E SLIP ON	1.03
3" TABLE E SLIP ON	1.65
4" TABLE E SLIP ON	2.40
6" TABLE E SLIP ON	5.14
8" TABLE E SLIP ON	7.50

Stainless Steel BS4504/BSEN 1092 Flanges PN16/105 Raised Face Blind Grades 304L & 316L

Size	KG/Unit
1" PN 16/105 RF BLIND	1.30
1½" PN 16/105 RF BLIND	2.30
2" PN 16/105 RF BLIND	3.00
3" PN 16/105 RF BLIND	5.10
4" PN 16/105 RF BLIND	6.00
6" PN 16/105 RF BLIND	11.10

Stainless Steel BS4504/BSEN 1092 Flanges PN16/101 Raised Face Slip On Grades 304L & 316L

Size	KG/Unit
½" PN 16/101 RF S.O.	0.75
¾" PN 16/101 RF S.O.	0.90
1" PN 16/101 RF S.O.	1.10
1¼" PN 16/101 RF S.O.	1.70
1½" PN 16/101 RF S.O.	2.00
2" PN 16/101 RF S.O.	2.60
2½" PN 16/101 RF S.O.	3.20
3" PN 16/101 RF S.O.	4.10
4" PN 16/101 RF S.O.	4.40
6" PN 16/101 RF S.O.	7.20
8" PN 16/101 RF S.O.	9.90
10" PN 16/101 RF S.O.	14.30



Stainless Steel

Metric Tube and Fittings

Stainless Steel Metric Welded Tube EN10217-7-2006 TC1 Grades 304L & 316L

Size	KG/Metre
28mm O/D X 1.5MM WALL	0.99
38MM O/D X 1.5MM WALL	1.37
43MM O/D X 1.5MM WALL	1.56
44.5MM O/D X 2.0MM WALL	2.13
53MM O/D X 1.5MM WALL	1.93
54MM O/D X 2.0MM WALL	2.40
83MM O/D X 1.5MM WALL	3.06
84MM O/D X 2.0MM WALL	3.90
103MM O/D X 1.5MM WALL	3.81
104MM O/D X 2.0MM WALL	5.12
129 MM O/D 2.0MM WALL	6.35
153MM O/D X 1.5MM WALL	5.68
154MM O/D X 2.0MM WALL	7.60
204MM O/D X 2.0MM WALL	10.1
254MM O/D X 2.0MM WALL	15.8
304MM O/D X 2.0MM WALL	15.1

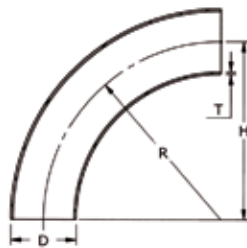

Welded 45° & 90° elbows
(radius $D+100$)

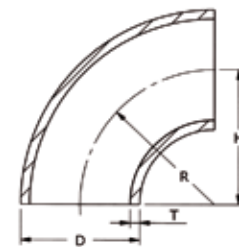

Welded 45° & 90° elbows
(radius $1.5D$)

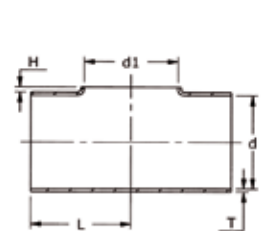

Pulled equal and reducing tees

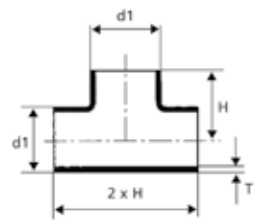

Equal tees with branch

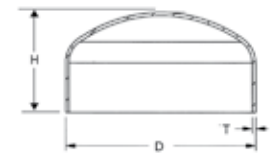

Pressed end caps

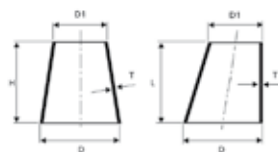

Concentric and eccentric reducers

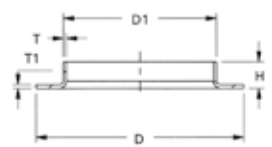

Pressed collars

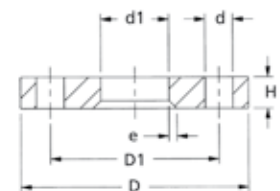

Flanges

Stainless Steel

Seamless Tube

Seamless Stainless Steel Tube ASTM A269/A213
Grade 316

Size	KG/Metre
1/8" OD X 0.022" (24swg)	0.04
1/8" OD X 0.028" (22swg)	0.04
1/8" OD X 0.036" (20swg)	0.05
3/16" OD X 0.022" (24swg)	0.06
3/16" OD X 0.028" (22swg)	0.07
3/16" OD X 0.036" (20swg)	0.09
3/16" OD X 0.048" (18swg)	0.11
1/4" OD X 0.028" (22swg)	0.10
1/4" OD X 0.036" (20swg)	0.12
1/4" OD X 0.048" (18swg)	0.16
1/4" OD X 0.064" (16swg)	0.19
5/16" OD X 0.028" (22swg)	0.13
5/16" OD X 0.036" (20swg)	0.16
5/16" OD X 0.064" (16swg)	0.26
3/8" OD X 0.028" (22swg)	0.16
3/8" OD X 0.036" (20swg)	0.20
3/8" OD X 0.048" (18swg)	0.25
3/8" OD X 0.064" (16swg)	0.32
3/8" OD X 0.080" (14swg)	0.38
1/2" OD X 0.028" (22swg)	0.21
1/2" OD X 0.036" (20swg)	0.26
1/2" OD X 0.048" (18swg)	0.35
1/2" OD X 0.064" (16swg)	0.45
1/2" OD X 0.080" (14swg)	0.54
1/2" OD X 0.125"	0.76
5/8" OD X 0.036" (20swg)	0.34

continued...

Size	KG/Metre
5/8" OD X 0.048" (18swg)	0.45
5/8" OD X 0.064" (16swg)	0.58
5/8" OD X 0.080" (14swg)	0.70
5/8" OD X 0.125"	1.01
3/4" OD X 0.036" (20swg)	0.41
3/4" OD X 0.048" (18swg)	0.54
3/4" OD X 0.064" (16swg)	0.71
3/4" OD X 0.080" (14swg)	0.86
3/4" OD X 0.104" (12swg)	1.08
3/4" OD X 0.128" (10swg)	1.26
7/8" OD X 0.064" (16swg)	0.84
1" OD X 0.036" (20swg)	0.56
1" OD X 0.048" (18swg)	0.74
1" OD X 0.064" (16swg)	0.97
1" OD X 0.080" (14swg)	1.19
1" OD X 0.104" (12swg)	1.50
1" OD X 0.128" (10swg)	1.77
1 1/4" OD X 0.064" (16swg)	1.20
1 1/4" OD X 0.080" (14swg)	1.50
1 1/4" OD X 0.125"	2.30
1 1/2" OD X 0.064" (16swg)	1.50
1 1/2" OD X 0.125"	2.80
2" OD X 0.125"	3.79
2" OD X 0.250"	7.06
2 1/2" OD X 0.25"	9.10
3" OD X 0.064" (16swg)	3.00

continued...

Size	KG/Metre
3" OD X 0.128" (10swg)	5.90
3" OD X 0.250"	11.09



Stainless Steel

Seamless Tube

Seamless Stainless Steel Tube ASTM A269/A213
Grade 316

Size	KG/Metre
6.0mm OD X 0.50mm	0.07
6.0mm OD X 1.0mm	0.13
6.0mm OD X 1.5mm	0.17
8.0mm OD X 1.0mm	0.18
8.0mm OD X 1.5mm	0.24
10.0mm OD X 1.0mm	0.23
10.0mm OD X 1.5mm	0.32
10.0mm OD X 2.0mm	0.40
12.0mm OD X 1.0mm	0.30
12.0mm OD X 1.5mm	0.39
12.0mm OD X 2.0mm	0.50
15.0mm OD X 1.5mm	0.50
16.0mm OD X 1.5mm	0.54
16.0mm OD X 2.0mm	0.70
18.0mm OD X 1.5mm	0.61
20.0mm OD X 1.5mm	0.69
20.0mm OD X 2.0mm	0.90
22.0mm OD X 1.5mm	0.77
25.0mm OD X 1.5mm	0.90
25.0mm OD X 2.0mm	1.20
25.0mm OD X 2.5mm	1.40
25.0mm OD X 3.0mm	1.70

Seamless Stainless Steel Tube ASTM A269/A213
Grade 304

Size	KG/Metre
6.0mm OD X 1.0mm	0.12
10.0mm OD X 1.0mm	0.22
12.0mm OD X 1.0mm	0.30
15.0mm OD X 1.5mm	0.50

Seamless Stainless Steel Tube ASTM A269/A213
Grade 304

Size	KG/Metre
¼" OD X 0.036" (20swg)	0.12
5/8" OD X 0.036" (20swg)	0.34
½" OD X 0.048" (18swg)	0.35
¾" OD X 0.036" (20swg)	0.41
5/8" OD X 0.048" (18swg)	0.44
5/8" OD X 0.064" (16swg)	0.58
¾" OD X 0.064" (16swg)	0.70
1" OD X 0.048" (18swg)	0.73



Stainless Steel

BSP Fittings

Sizes: 1/8", 1/4", 3/8", 1/2", 3/4", 1", 1 1/2", 2", 3"



90° Elbow



Equal Tee

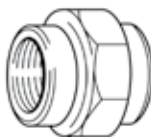

Union

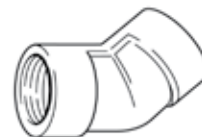

45° Elbow



Half Socket

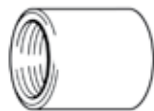

Socket



Round Nut



Reducing Socket

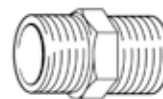

Hexagon Nipple

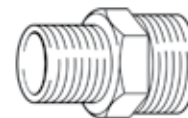

Reducing Nipple



Equal Nipple



Cap

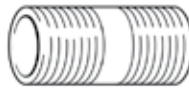

Barrel Nipple



Welding Nipple



Square Head Plug



Hexagon Head Plug



Hose Connector

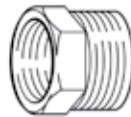

Reducing Bush



Hexagon Nut

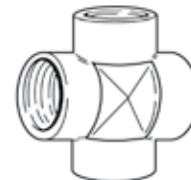

Cross

Stainless Steel

Hygienic Tube and Fittings

Stainless Steel Hygienic Tube to ASTM A270 Grades 304L & 316L. Available in Bright Annealed or with Satin Polished O/D

Size	KG/Metre
¾" O/D X 16SWG	0.72
1" O/D X 16SWG	0.97
1½" O/D X 16SWG	1.45
2" O/D X 16SWG	1.99
2½" O/D X 16SWG	2.51
3" O/D X 16SWG	3.02
4" O/D X 16SWG	4.04
4" O/D X 14SWG	5.02

Stainless Steel Hygienic Tube to DIN 11850 - UN-ANNEALED - Grade 316L. Available Descaled or with Satin Polished O/D

Size	KG/Metre
1" OD X 1.5mm	0.9
1½" OD X 1.5mm	1.37
2" OD X 1.5mm	1.85
2½" OD X 1.5mm	2.33
3" OD X 1.5mm	2.8
4" OD X 1.5mm	3.75
4" OD X 2.0mm	4.98
4" O/D X 14SWG	5.02

Stainless Steel Hygienic Tube to DIN 11850 - UN-ANNEALED - Grade 304. Available Descaled or with Satin Polished O/Dt

Size	KG/Metre
1" OD X 1.5mm	0.9
1½" OD x 1.5mm	1.37
2" OD X 1.5mm	1.85



Clamp Fittings



RJT Unions



IDF Unions



Hinged Pipe Clip



Hygienic Bends

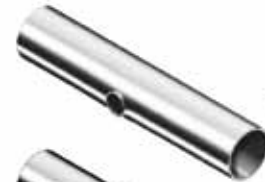

Pulled Tees



Full Tees



Reducing Tees



Concentric and Eccentric Reducers

Stainless Steel

Handrail Tube and Fittings

Stainless Steel Handrail Tube Grade 304 & 316 - Satin Polish O/D

Size	KG/Metre
1" OD X 3.0mm	1.68
2" OD X 3.0mm	3.57
3" OD X 3.0mm	5.46
4" OD X 3.0mm	7.40
42.4mm OD X 2.0mm	2.01
48.3mm OD x 2.0mm	2.32
60.3mm OD X 2.0mm	2.92
42.4mm OD X 2.5mm	2.49
48.3mm OD X 2.5mm	2.86
60.3mm OD X 2.5mm	3.61

Stainless Steel UN-ANNEALED Handrail Tube Grade 304 - Descaled Finish

Size	KG/Metre
42.2mm OD X 1.6mm 304	1.62
60.3mm OD X 1.6mm 304	2.33
76.1mm OD X 1.6mm 304	2.96
101.6mm OD X 2.0mm 304	4.94



Glass Clamps



Glass Clamp



Glass Clamp



Glass Clamp



Glass Clamp

Fittings



Adjustable Elbow



90 Degree Elbow



45 Degree Elbow



90 Degree Curved Elbow

Fittings



Flexible Elbow



Internal Connector



Crossbar Holder Intermediate



Flush Tee Connector

Fittings



4-way Corner Connector



Cross Connector



3-way Corner Connector



Adaptor

Stainless Steel

Handrail Tube and fittings



Mountings



Floor Base (indoor use)

Mountings



Floor Base (outdoor use)

Mountings



Elbow with Flange

End Caps



Flat Cap

Handrail Brackets



Straight Saddle

Handrail Brackets



Handrail Holder



Disc



Cover Plate



Elbow with Flange



End Caps



Adjustable Saddle



Handrail Holder



Wall Flange



Disc

End Caps



End Caps



End Caps with M8



End Caps



Wall Support



Handrail Holder



Side Mounted Base



Side Mounted Base



Wall Support

Stainless Steel

Slotted Tube system and fittings

Stainless Steel Slotted Handrail Tube
Grades 304 & 316

Size	KG/Metre
42.2MM X 1.5MM	1.83
48.3MM X 1.5MM	2.17



Slotted tube



End caps



90 degree angle - vertical



90 degree angle - horizontal



Connector



Rubber inserts

Stainless Steel

Accessories - Adhesive & Cleaners



Degreasing Spray



Protection Spray



Stainless Steel Cleaning & Passivation Kit



Stainless Steel Glue

The kit comprises a viscous deep cleaner that removes contamination such as oxides/rust/tea-stains plus a passivating agent that will also remove contamination loosened by the deep cleaner. An application sponge is also included.

Copper, Brass & Bronze

Copper	
Sheet.....	52
Rod	52
Flat Bar.....	53
Round Tube.....	54
Brass	
Sheet.....	55
Rod	56
Hexagon Bar.....	58
Flat Bar.....	59
Plate.....	60
Tube	60
Square Bar.....	60
Equal Angle.....	60
Bronze	
Rod	61



Copper Sheet



Copper Sheet Alloy CW024A/C106 Half Hard

Size	KG/Sheet
4' X 2' X 24SWG	3.70
4' X 2' X 22SWG	4.70
4' X 2' X 20SWG	6.02
4' X 2' X 18SWG	8.07
4' X 2' X 16SWG	10.8
4' X 2' X 14SWG	13.4
4' X 2' X 10SWG	21.5
8' X 4' X 18SWG	32.3
8' X 4' X 1.6mm	42.3
8' X 4' X 2.0mm	52.9
8' X 4' X 3.0mm	79.4
8' X 4' X 4.0mm	105.8
2000mm X 1000mm X 0.55mm	9.8
2000mm X 1000mm X 0.7mm	12.5
2000mm X 1000mm X 0.9mm	16.0
2000mm X 1000mm X 1.2mm	21.4
2000mm X 1000mm X 1.5mm	26.7
2000mm X 1000mm X 2.0mm	35.6
2000mm X 1000mm X 2.5mm	44.5
2000mm X 1000mm X 3.0mm	53.4
2000mm X 1000mm X 4.0mm	74.0
2000mm X 1000mm X 5.0mm	92.6
2000mm X 1000mm X 6.0mm	111



Copper Sheet Alloy CW004A/C101 Half Hard

Size	KG/Sheet
4' X 2' X 20SWG	6.02
4' X 2' X 10SWG	21.5
1200mm X 600mm X 1.6mm	10.3
1200mm X 600mm X 2.0mm	12.8
2000mm X 1000mm X 0.9mm	16.0
2000mm X 1000mm X 1.2mm	21.4
2000mm X 1000mm X 1.5mm	26.7
2000mm X 1000mm X 2.0mm	35.6
2000mm X 1000mm X 3.0mm	53.4
2000mm X 1000mm X 4.0mm	74.0
2000mm X 1000mm X 5.0mm	92.6
2000mm X 1000mm X 6.0mm	111

Copper Sheet Alloy CW024A/C106 - Soft - Spinning Quality

Size	KG/Sheet
4' X 2' X 24SWG	3.70
4' X 2' X 20SWG	6.02
4' X 2' X 18SWG	8.07
2000mm X 1000mm X 0.55mm	9.8
2000mm X 1000mm X 0.7mm	12.5
2000mm X 1000mm X 0.9mm	16.0
2000mm X 1000mm X 1.2mm	21.4
2000mm X 1000mm X 1.5mm	26.7

Rod



Copper Rod CW004A/C101 - Hard Drawn High Conductivity

Size	KG/Metre
¼" DIA	0.28
5/16" DIA	0.44
3/8" DIA	0.63
½" DIA	1.13
5/8" DIA	1.76
¾" DIA	2.54
7/8" DIA	3.45
1" DIA	4.51
1 1/8" DIA	5.71
1 ¼" DIA	7.05
1 3/8" DIA	8.53
1 ½" DIA	10.1
1 5/8" DIA	11.9
2" DIA	18.0
2 ¼" DIA	22.8
2 ½" DIA	28.2
4" DIA	72.2
10.0mm DIA	0.70
12.0mm DIA	1.01
16.0mm DIA	1.79
20.0mm DIA	2.80
25.0mm DIA	4.37
30.0mm DIA	6.29
40.0mm DIA	11.2
50.0mm DIA	17.5

Copper

Flat Bar

Copper Flat Bar - Radius Edge - Alloy CW004A/C101



Size	KG/Metre
½" X 1/8" Rad Edge	0.36
½" X 3/16" Rad Edge	0.54
5/8" X 1/8" Rad Edge	0.45
½" X ¼" Rad Edge	0.72
¾" X 1/8" Rad Edge	0.54
¾" X 3/16" Rad Edge	0.81
¾" X ¼" Rad Edge	1.08
1" X 1/8" Rad Edge	0.72
1" X 3/16" Rad Edge	1.07
1" X ¼" Rad Edge	1.44
1" X ½" Rad Edge	2.87
1¼" X 1/8" Rad Edge	0.90
1¼" X ¼" Rad Edge	1.79
1½" X 1/8" Rad Edge	1.08
1½" X 3/16" Rad Edge	1.61
1½" X ¼" Rad Edge	2.15
1½" X 3/8" Rad Edge	3.23
2" X 1/8" Rad Edge	1.44
2" X 3/16" Rad Edge	2.15
2" X ¼" Rad Edge	2.87
2" X 3/8" Rad Edge	4.31
2" X ½" Rad Edge	5.74
2" X ¾" Rad Edge	8.61
2½" X ¼" Rad Edge	3.59
2½" X 3/8" Rad Edge	5.39
2½" X ½" Rad Edge	7.18

continued...

Size	KG/Metre
3" X ¼" Rad Edge	4.31
3" X 3/8" Rad Edge	6.46
3" X ½" Rad Edge	8.61
4" X ¼" Rad Edge	5.74
4" X 3/8" Rad Edge	8.62
4" X ½" Rad Edge	11.48
5" X ¼" Rad Edge	7.18
5" X ½" Rad Edge	14.35
6" X ¼" Rad Edge	8.61
20mm X 5mm Rad Edge	0.89
20mm X 6mm Rad Edge	1.07
20mm X 10mm Rad Edge	1.78
25mm X 3mm Rad Edge	0.67
25mm X 5mm Rad Edge	1.11
25mm X 6mm Rad Edge	1.34
25mm X 10mm Rad Edge	2.23
30mm X 3mm Rad Edge	0.80
30mm X 5mm Rad Edge	1.34
30mm X 6mm Rad Edge	1.60
30mm X 10mm Rad Edge	2.67
40mm X 5mm Rad Edge	1.78
40mm X 6mm Rad Edge	2.14
40mm X 8mm Rad Edge	2.85
40mm X 10mm Rad Edge	3.56
50mm X 5mm Rad Edge	2.23

continued...

Size	KG/Metre
50mm X 6mm Rad Edge	2.67
50mm X 8mm Rad Edge	3.56
50mm X 10mm Rad Edge	4.45
50mm X 12mm Rad Edge	5.34
60mm X 6mm Rad Edge	3.20
60mm X 10mm Rad Edge	5.34
80mm X 10mm Rad Edge	7.12
100mm X 6mm Rad Edge	5.34
100mm X 10mm Rad Edge	8.90
120mm X 10mm Rad Edge	10.68
150mm X 6mm Rad Edge	8.01
150mm X 10mm Rad Edge	13.35
200mm X 10mm Rad Edge	17.80



Copper

Round Tube

Copper Tube Alloy CW024A/C106

Size	KG/Metre
¼ o / d X 20 swg	0.14
¼ o / d X 18 swg	0.17
3/8 o / d X 20 swg	0.22
3/8 o / d X 18 swg	0.29
½ o / d X 20 swg	0.30
½ o / d X 18 swg	0.39
½ o / d X 16 swg	0.50
5/8 o / d X 20 swg	0.38
¾ o / d X 20 swg	0.46
¾ o / d X 18 swg	0.61
¾ o / d X 16 swg	0.79
7/8 o / d X 20 swg	0.54
7/8 o / d X 18 swg	0.72
7/8 o / d X 16 swg	0.94
1 o / d X 20 swg	0.63
1 o / d X 18 swg	0.83
1 o / d X 16 swg	1.08
1¼ o / d X 16 swg	1.37
1½ o / d X 16 swg	1.66
2 o / d X 16 swg	2.24
2½ o / d X 16 swg	2.81

Brass

Sheet

Brass Sheet Alloy CW508L/CZ108 - In Half Hard Condition

Size	KG/Sheet
4' X 2' X 0.55mm	3.45
4' X 2' X 0.90mm	5.65
4' X 2' X 18SWG	7.66
4' X 2' X 16SWG	10.24
4' X 2' X 2.0mm	12.6
4' X 2' X 12SWG	16.7
4' X 2' X 10SWG	20.4
8' X 1000mm X 0.9mm	18.5
8' X 1000mm X 1.2mm	24.7
8' X 1000mm X 1.5mm	30.9
8' X 4' X 18SWG	30.6
8' X 4' X 1.6mm	40.2
8' X 4' X 14SWG	51.0
8' X 4' X 10SWG	81.6
2000mm X 1000mm X 0.45mm	7.61
2000mm X 1000mm X 0.55mm	9.30
2000mm X 1000mm X 0.7mm	11.83
2000mm X 1000mm X 0.9mm	15.21
2000mm X 1000mm X 1.2mm	20.28
2000mm X 1000mm X 1.5mm	25.35
2000mm X 1000mm X 2.0mm	33.80
2000mm X 1000mm X 2.5mm	42.25
2000mm X 1000mm X 3.0mm	50.70

Brass Sheet Alloy CW505L/CZ106 - In Soft (O) Condition

Size	KG/Sheet
4' X 2' X 24SWG	3.51
4' X 2' X 20SWG	5.70
4' X 2' X 18SWG	7.64
2000mm X 1000mm X 0.55mm	9.27
2000mm X 1000mm X 0.7mm	11.80
2000mm X 1000mm X 0.9mm	15.17
2000mm X 1000mm X 1.2mm	20.23
2000mm X 1000mm X 1.6mm	26.98
2000mm X 1000mm X 2.0mm	33.72

Polished Brass Sheet Alloy CW508L/CZ108 - In Half Hard Condition

Size	KG/Sheet
2000mm X 1000mm X 0.55mm	9.43
2000mm X 1000mm X 0.7mm	12.0
2000mm X 1000mm X 0.9mm	15.4
2000mm X 1000mm X 1.2mm	20.6
2000mm X 1000mm X 1.5mm	25.7
2000mm X 1000mm X 2.0mm	34.3
2000mm X 1000mm X 2.5mm	42.9
2000mm X 1000mm X 3.0mm	51.5
8' X 1000mm X 1.2mm	25.1
8' X 1000mm X 1.5mm	31.4





Brass Rod

Brass Rod Alloy CW614N/CZ121 - Free Machining Brass

Size	KG/Metre
1/8" DIA	0.07
5/32" DIA	0.11
4.0mm DIA	0.11
3/16" DIA	0.15
5.0mm DIA	0.17
7/32" DIA	0.21
6.0mm DIA	0.24
1/4" DIA	0.27
7.0mm DIA	0.33
9/32" DIA	0.34
5/16" DIA	0.42
8.0mm DIA	0.43
11/32" DIA	0.51
9.0mm DIA	0.54
3/8" DIA	0.61
10.0mm DIA	0.67
7/16" DIA	0.82
12.0mm DIA	0.96
1/2" DIA	1.08
13.0mm DIA	1.13
17/32" DIA	1.21
14.0mm DIA	1.31
9/16" DIA	1.36
15.0mm DIA	1.50
5/8" DIA	1.68
16.0mm DIA	1.71

continued...

Size	KG/Metre
17.0mm DIA	1.93
11/16" DIA	2.04
18.0mm DIA	2.16
3/4" DIA	2.42
20.0mm DIA	2.67
13/16" DIA	2.84
22.0mm DIA	3.23
7/8" DIA	3.30
15/16" DIA	3.78
24.0mm DIA	3.85
25.0mm DIA	4.17
1" DIA	4.31
26.0mm DIA	4.51
11/16" DIA	4.86
28.0mm DIA	5.23
11/8" DIA	5.45
30.0mm DIA	6.01
13/16" DIA	6.07
1 1/4" DIA	6.73
15/16" DIA	7.42
13/8" DIA	8.15
35.0mm DIA	8.18
1 1/2" DIA	9.69
40.0mm DIA	10.7
15/8" DIA	11.4
1 3/4" DIA	13.2

continued...

Size	KG/Metre
17/8" DIA	15.1
50.0mm DIA	16.7
2" DIA	17.2
21/8" DIA	19.4
2 1/4" DIA	21.8
60.0mm DIA	24.0
23/8" DIA	24.3
2 1/2" DIA	26.9
65.0mm DIA	28.2
25/8" DIA	29.7
2 3/4" DIA	32.6
3" DIA	38.8
3 1/4" DIA	45.5
3 1/2" DIA	52.8
3 3/4" DIA	60.6
4" DIA	68.9
4 1/4" DIA	77.8
4 1/2" DIA	87.2
130mm DIA	113
155mm DIA	160
180mm DIA	216
205mm DIA	281

Brass

Rod



Brass Rod Alloy CW721R & 722R / CZ114 - High Tensile Brass / Manganese Bronze

Size	KG/Metre
3/8" DIA	0.59
1/2" DIA	1.04
5/8" DIA	1.63
3/4" DIA	2.34
13/16" DIA	2.75
7/8" DIA	3.19
1" DIA	4.16
1 1/4" DIA	6.51
1 3/8" DIA	7.87
1 1/2" DIA	9.37
1 3/4" DIA	12.8
2" DIA	16.7
2 1/4" DIA	21.1
2 1/2" DIA	26.0
2 3/4" DIA	31.5
3" DIA	37.5
4" DIA	66.6

Brass Rod Alloy CW606N/CZ131 - Riveting Quality Brass

Size	KG/Metre
1/4" DIA	0.27
5/16" DIA	0.42
3/8" DIA	0.61
7/16" DIA	0.82
1/2" DIA	1.08
5/8" DIA	1.68
3/4" DIA	2.42

Brass Rod Alloy CW712R/CZ112 - Naval Brass

Size	KG/Metre
3/4" DIA	2.41
1" DIA	4.28
1 1/4" DIA	6.69
1 1/2" DIA	9.63
1 3/4" DIA	13.1
2" DIA	17.1
2 1/2" DIA	26.8
3" DIA	38.5



Brass

Hexagon Bar

Brass Hexagon Bar Alloy CW614N/CZ121

Size	KG/Metre
5.0mm A/F	0.18
6.0mm A/F	0.27
0.248" A/F	0.29
¼" A/F	0.30
5/16" A/F	0.46
8.0mm A/F	0.47
0.324" A/F	0.50
3/8" A/F	0.67
10.0mm A/F	0.74
11.0mm A/F	0.89
7/16" A/F	0.91
0.445" A/F	0.94
12.0mm A/F	1.06
½" A/F	1.19
13.0mm A/F	1.24
0.525" A/F	1.31
14.0mm A/F	1.44
9/16" A/F	1.50
15.0mm A/F	1.66
.600" A/F	1.71
5/8" A/F	1.71
16.0mm A/F	1.88
17.0mm A/F	2.13
11/16" A/F	2.24
18.0mm A/F	2.39
0.710" A/F	2.39

continued...

Size	KG/Metre
19.0mm A/F	2.66
¾" A/F	2.67
20.0mm A/F	2.94
13/16" A/F	3.14
0.820" A/F	3.19
22.0mm A/F	3.56
7/8" A/F	3.64
0.920" A/F	4.02
15/16" A/F	4.17
24.0mm A/F	4.24
1" A/F	4.75
1.010" A/F	4.84
11/16" A/F	5.36
1.100" A/F	5.75
11/8" A/F	6.01
30.0mm A/F	6.63
1.200" A/F	6.84
1¼" A/F	7.42
32.0mm A/F	7.54
1.300" A/F	8.03
15/16" A/F	8.18
13/8" A/F	8.98
36.0mm A/F	9.54
1.480" A/F	10.40
1½" A/F	10.69
41.0mm A/F	12.37

continued...

Size	KG/Metre
1.625" A/F	12.54
1.670" A/F	13.25
46.0mm A/F	15.58
1.860" A/F	16.43
50.0mm A/F	18.40
2.050" A/F	19.96
2.200" A/F	22.99
60.0mm A/F	26.50
2½" A/F	29.68
65.0mm A/F	31.10
2¾" A/F	35.92
3" A/F	42.74

Brass

Flat Bar



Brass Flat Bar CW614N/CZ121

Size	KG/Metre
3/8" X 1/8"	0.26
3/8" X 1/4"	0.51
1/2" X 1/8"	0.34
5/8" X 1/8"	0.43
5/8" X 1/4"	0.86
5/8" X 3/8"	1.29
1/2" X 1/4"	0.69
3/4" X 1/8"	0.51
3/4" X 3/16"	0.77
3/4" X 1/4"	1.03
3/4" X 3/8"	1.54
3/4" X 1/2"	2.06
1" X 1/8"	0.69
1" X 3/16"	1.03
1" X 1/4"	1.37
1" X 5/16"	1.71
1" X 3/8"	2.06
1" X 1/2"	2.74
1" X 5/8"	3.43
1" X 3/4"	4.11
1 1/4" X 1/8"	0.86
1 1/4" X 1/4"	1.71
1 1/4" X 3/8"	2.57
1 1/4" X 1/2"	3.43
1 1/4" X 3/4"	5.14
1 1/4" X 1"	6.85

continued...

Size	KG/Metre
1 1/2" X 1/8"	1.03
1 1/2" X 3/16"	1.54
1 1/2" X 1/4"	2.06
1 1/2" X 3/8"	3.09
1 1/2" X 1/2"	4.11
1 1/2" X 5/8"	5.14
1 1/2" X 3/4"	6.17
1 1/2" X 1"	8.23
1 3/4" X 1/2"	4.80
2" X 1/8"	1.37
2" X 3/16"	2.05
2" X 1/4"	2.74
2" X 3/8"	4.12
2" X 1/2"	5.48
2" X 5/8"	6.86
2" X 3/4"	8.23
2" X 1"	10.97
2" X 1 1/4"	13.71
2" X 1 1/2"	16.45
2 1/2" X 1/4"	3.43
2 1/2" X 3/8"	5.14
2 1/2" X 1/2"	6.85
2 1/2" X 3/4"	10.28
2 1/2" X 1"	13.71
2 1/2" X 1 1/4"	17.14
2 1/2" X 1 1/2"	20.56

continued...

Size	KG/Metre
3" X 1/8"	2.06
3" X 1/4"	4.11
3" X 3/8"	6.17
3" X 1/2"	8.23
3" X 1"	16.45
3" X 1 1/2"	24.68
3" X 2"	32.90
4" X 1/8"	2.75
4" X 1/4"	5.48
4" X 1/2"	10.97
4" X 3/4"	16.45
4" X 1 1/2"	32.90

Brass Plate



Brass Plate Alloy CW508L/CZ108 Half Hard

Size	KG/Plate
2000mm X 1000mm X 4.0mm	69
2000mm X 1000mm X 4.76mm	82
2000mm X 1000mm X 5.0mm	86
2000mm X 1000mm X 6.35mm	109



Tube

Brass Tube for Handrail/Bar-rail Alloy CW508L/CZ108

Size	KG/Metre
2" O/D X 16SWG	2.13

Square Bar



Brass Square Bar Alloy CW614N/CZ121

Size	KG/Metre
¼" SQ	0.34
5/16" SQ	0.54
3/8" SQ	0.77
7/16" SQ	1.05
½" SQ	1.37
5/8" SQ	2.14
¾" SQ	3.08
7/8" SQ	4.20
1" SQ	5.48
1¼" SQ	8.57
1½" SQ	12.3
1¾" SQ	16.8
2" SQ	21.9
2¼" SQ	27.8
2½" SQ	34.3
3" SQ	49.4

Equal Angle



Brass Angle Alloy CW624N/CZ130

Size	KG/Metre
½" X ½" X 1/8"	0.62
¾" X ¾" X 1/8"	0.97
1" X 1" X 1/8"	0.13
1¼" X 1¼" X 1/8"	1.68
1½" X 1½" X 1/8"	2.03
1½" X 1½" X 3/16"	2.98
2" X 2" X 1/8"	2.74
2" X 2" X ¼"	5.30
3" X 3" X ¼"	8.12

Bronze

Rod

Aluminium Bronze Rod CW307G/CA104

Size	KG/Metre
½"	0.96
5/8"	1.50
¾"	2.35
1"	3.85
1¼"	6.10
1½"	8.66
1¾"	12.00
2"	15.40
2¼"	21.00
2½"	24.90
2¾"	29.60
3"	34.70
3½"	47.20
4"	61.60
4½"	78.0
5"	96.3
5½"	116
6"	139
6½"	165
7"	189
7½"	249
8"	246
9"	312
10"	385
12"	556

Aluminium Bronze Rod DEF-STAN 833 (NES 833)
Grade 1

Size	KG/Metre
3/8"	0.54
½"	0.96
5/8"	1.50
¾"	2.17
7/8"	2.96
1"	3.85
1¼"	6.02
1½"	8.66
1¾"	11.8
2"	15.4
2½"	24.1
3"	34.7
3½"	47.2
4"	61.6
4½"	78.0
5"	96.3
5½"	116
6"	139
6½"	165
7"	189
8"	249

Phosphor Bronze Rod CW451K/PB102

Size	KG/Metre
½"	1.12
5/8"	1.75
¾"	2.52
7/8"	3.43
1"	4.48
1 1/8"	5.68
1¼"	7.01
1 3/8"	8.48
1½"	10.0
1¾"	13.7
2"	17.9
2¼"	22.7
2½"	28.0
2¾"	33.9
3"	40.4
3¼"	47.6
3 ½"	54.9
4"	71.7



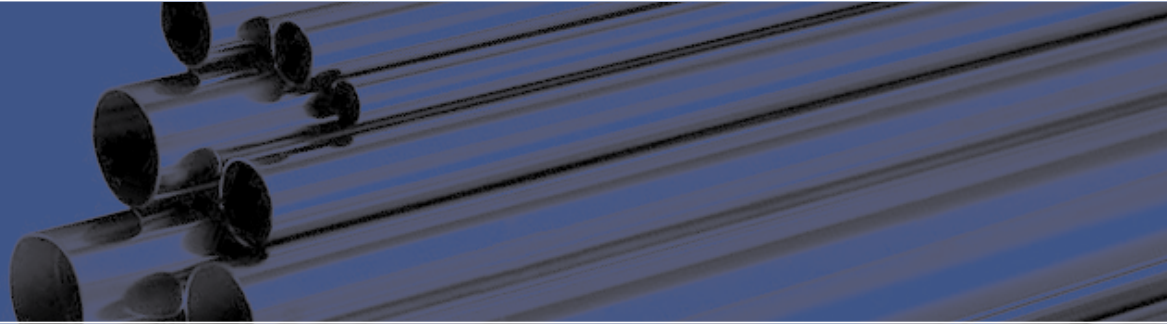

Sales Office

20D Horseshoe Park
Pangbourne
Reading
Berkshire
RG8 7JW

Tel: 0118 976 7140
Fax: 0118 976 7141
Email: sales@united-alloys.com

Collections and Deliveries

Upper Brook Street
Walsall
West Midlands
WS2 9PD

Tel: 01922 724732
Fax: 01922 616856