

Quality is more than a word

ESPEC

Electromigration Evaluation System

AEM Series



Electromigration evaluations at stresses of $1\mu\text{A}$ and 400°C

Today's more sophisticated, more highly integrated semiconductor devices are the result of ever more advanced microfabrication techniques and the use of new materials.

Since these techniques and materials determine device life, high-precision electromigration evaluations under more rigorous accelerated stress test conditions are becoming increasingly important to developers.

The Electromigration Evaluation System offers high-precision measurement under temperature (up to 400°C) and current stresses — the key conditions for accelerated stress testing.

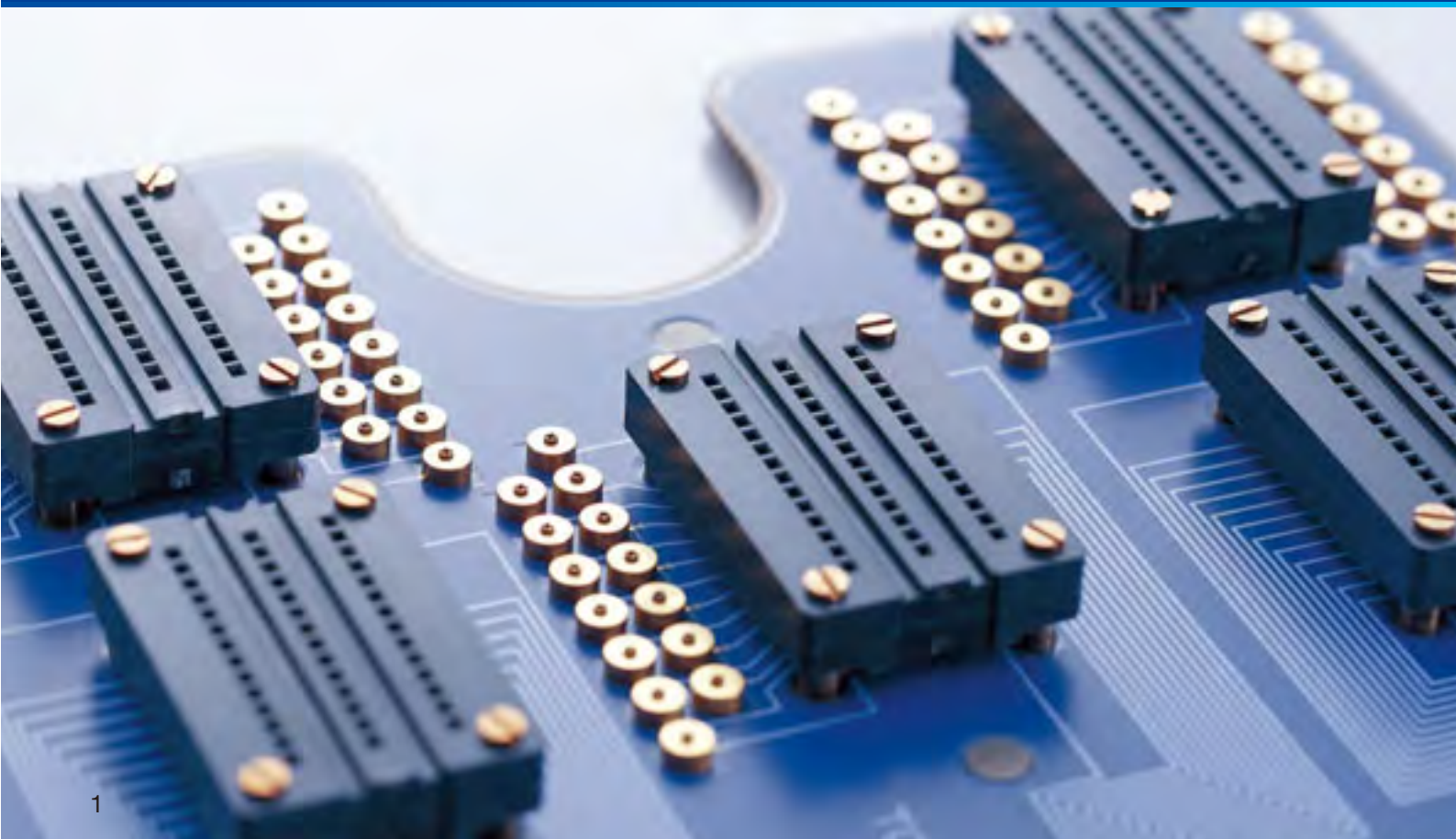

The analysis software provided enables calculations of the parameters needed to determine device life (based on Black's equation).

Offering better operation, reliability and data analysis, AEM can be used to meet evaluation needs in a wide range of applications, from cutting-edge evaluations to production management.



Performance



240ch type

- **Test up to 240 channels per cabinet**

Each oven can support up to 80 DUTs (8 DUT boards per oven × 5 sockets per DUT board × 1 or 2 DUTs per socket). Since test groups can have as few as five DUTs, each oven can have up to 16 sets of test conditions.

- **High-temperature (400°C max.), high-precision ovens**

AEM's ovens can create test temperatures of up to 400°C with outstanding precision ($\pm 2.5^\circ\text{C}$ distribution at 350°C setting). Up to three ovens can be mounted in each cabinet, and evaluations can use different temperature conditions in each oven.

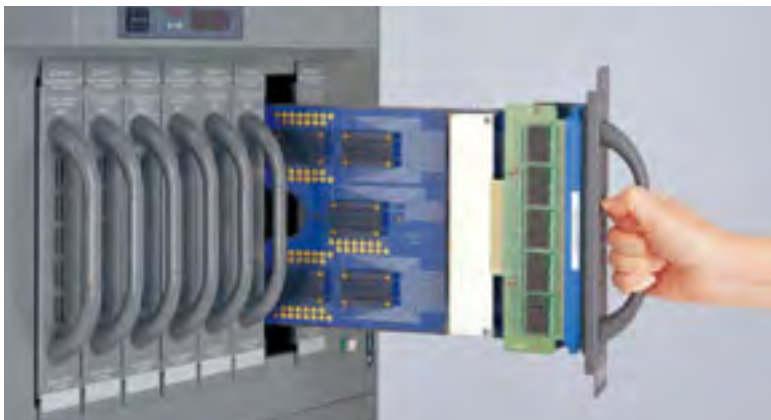

- **Low current stress (1 μA min.)**

To support future Copper interconnect evaluation requirements, AEM can apply stress currents of between 1 μA and 50 mA. Socket can be used for DIP 28-pin 600/300mil type.

- **New high-reliability DUT boards and sockets**

To ensure that components connect securely, DUT board-to-socket connections have been given a double contact structure (patent pending), and an original ESPEC design has been used for DUT-to-socket connections. These structural improvements dramatically reduce contact failure at high temperatures, enabling low-cost, high-cost-performance DUT boards that can withstand longer tests.

- **DUT board**

IC socket

Pin assignment scramble board

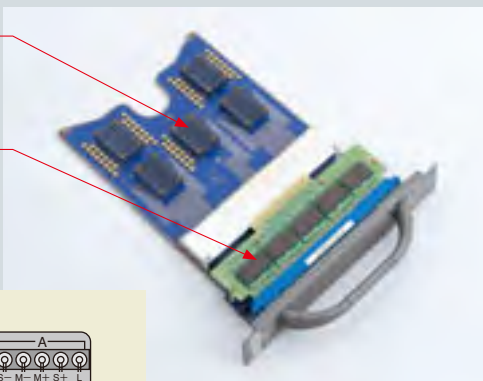

Scramble board

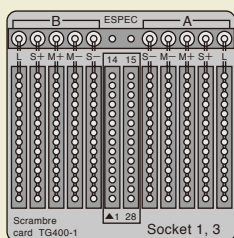

- **Pin assignment scrambling**

ESPEC DUT boards support pin assignment scrambling, enabling evaluations of DUTs with different pin assignments.

● PC-driven network

Up to five cabinets can be controlled from a single PC, enabling evaluations of up to 1,200 DUTs (1,200 channels). Evaluations can easily be monitored from a remote office.

● Four types of electromigration evaluation

AEM is a highly versatile system that supports four types of electromigration evaluation with temperature and current stresses applied: (1) constant-current stress testing (resistance measurement), (2) stress migration testing, (3) TCR (temperature characteristic testing for precise current resistance measurement) testing, and (4) extrusion testing (leak current measurement).

● Space-saving design

Since the ovens and tester have been combined into a single unit, up to three ovens can be stored in a single cabinet. Up to five cabinets can be controlled from a single PC, greatly reducing the space needed to evaluate large-volume specimens.

● System configuration (1200ch max)

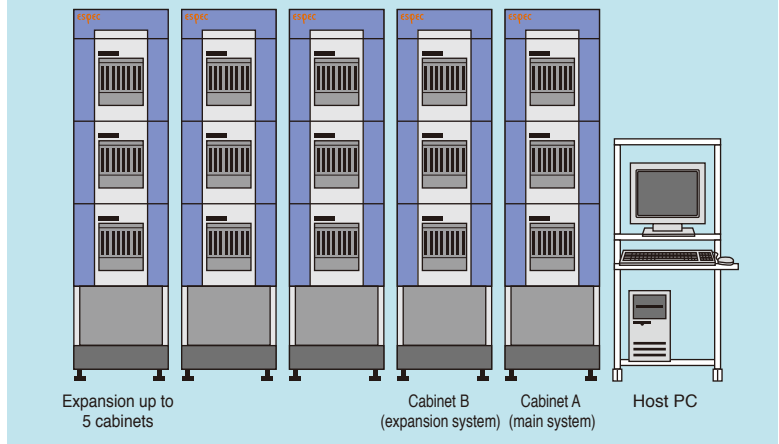

● Reliability concerns for Cu Damascene

Cu damascene offers the benefits of low resistance and high reliability, but a wide range of phenomena appear in via structures linking multi-layer wiring when subjected to thermal stress.

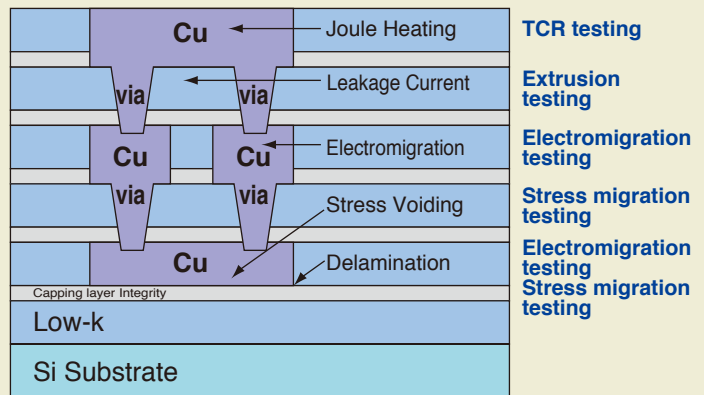

INSTRUMENTATION

● Monitor screen

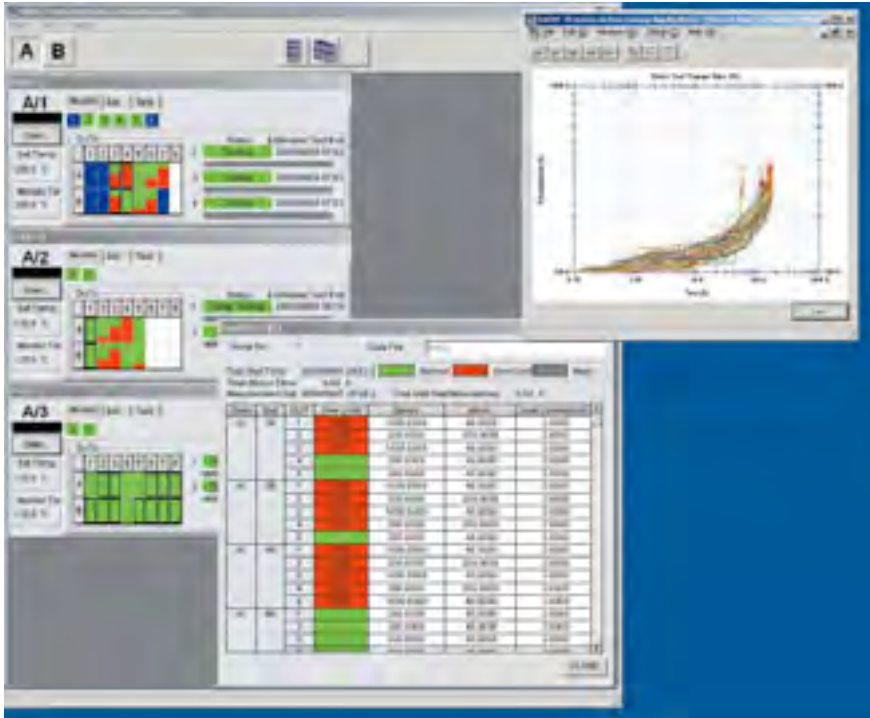

The monitor screen displays all the information needed at a glance, in a single screen in real-time. It contains multiple windows showing items such as the test progress (status) of each DUT, resistance values and rates of change (displayed graphically).

● Test condition/ Setup

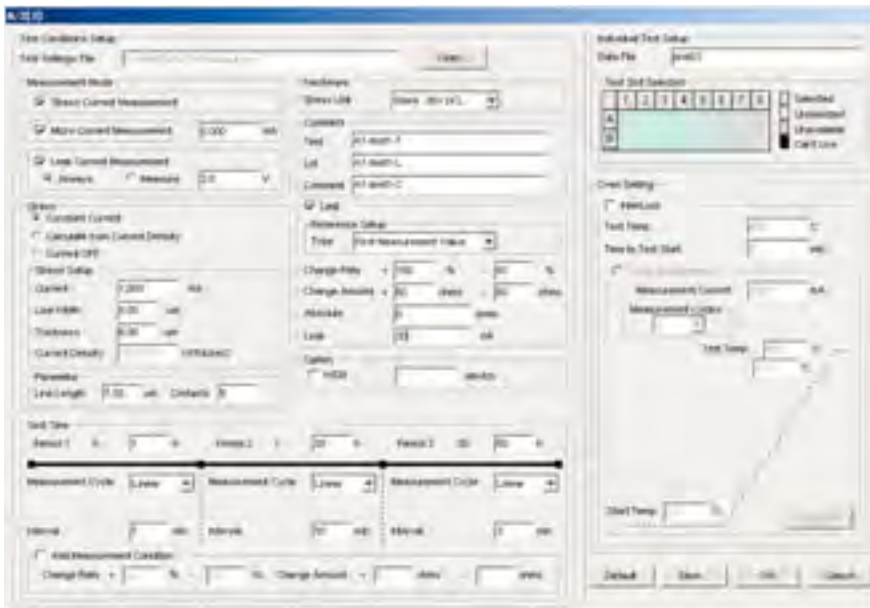

The 'Test Condition Set Up' window lets you enter and check all items in a single screen.

ANALYTICAL SOFTWARE

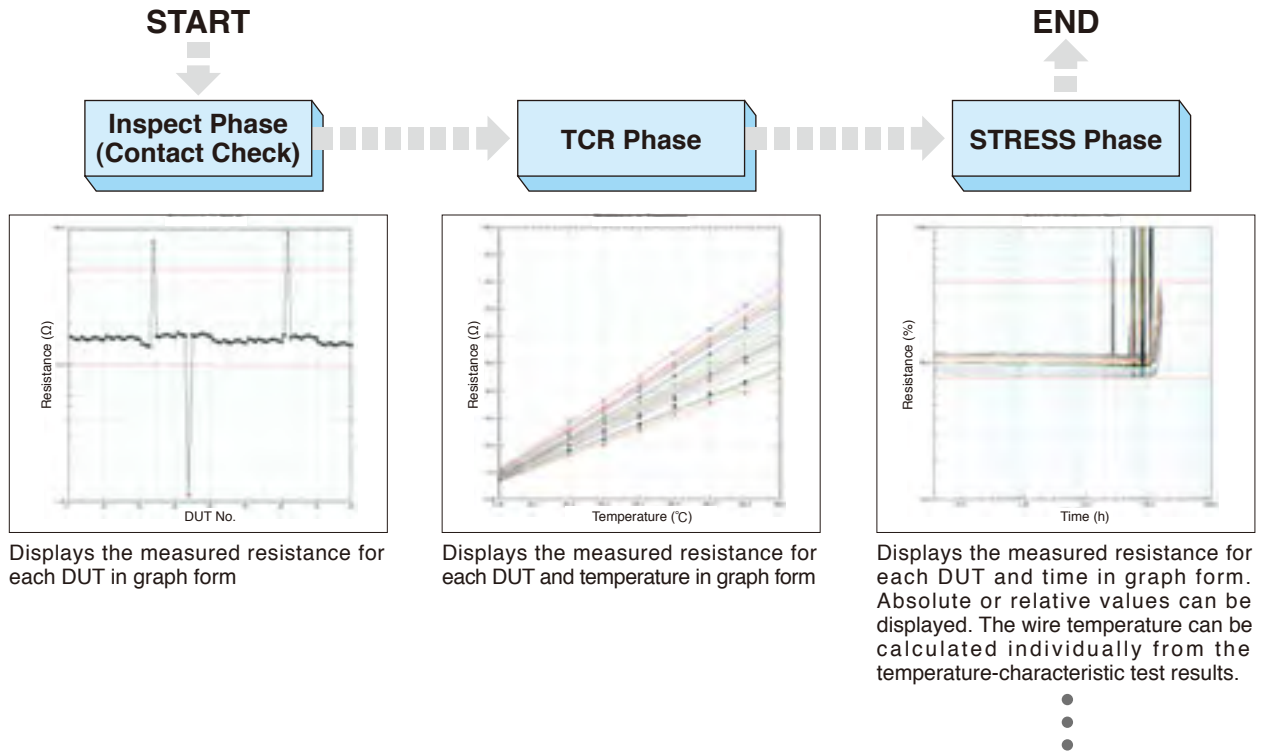

Distribution Plots (Normal/ Log Normal/ Weibull)

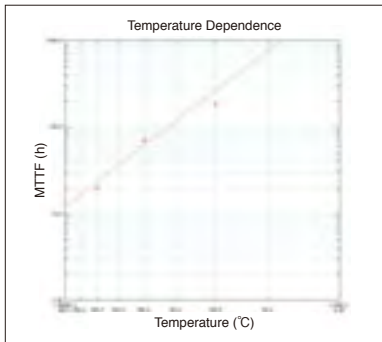
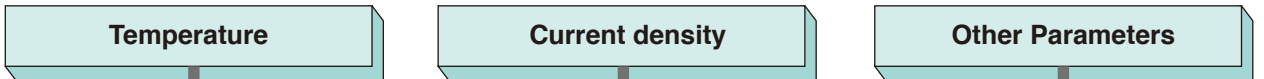

Displays the temperature-dependence in graph form based on the life (MTTF/median) calculated from the distribution plot. (Arrhenius plot)

Activation energy (Ea)

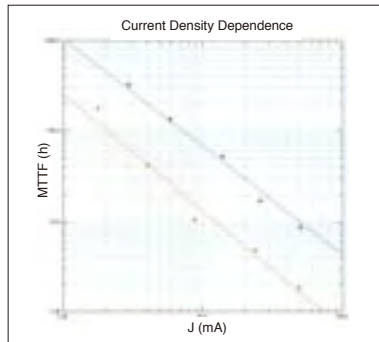

Displays the current density dependence in graph form based on the life (MTTF/median) calculated from the distribution plot.

Current density exponent

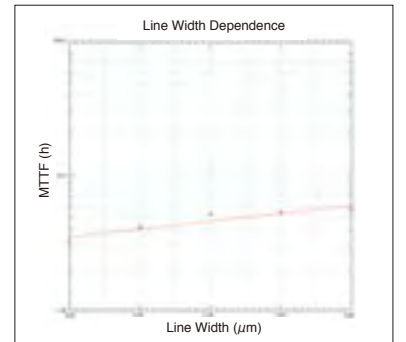

Displays in graph form the dependence on wire length, wire width, thickness and number of contacts.

Black's model

SPECIFICATIONS

Type of evaluation		<ul style="list-style-type: none"> • Electromigration (constant current) testing • Stress migration testing • Extrusion testing • TCR testing
Stress-current	Output range	+1 μ A to +50mA DC
	Accuracy	1 μ A to 1 mA: \pm (0.2% of S.V.+1 μ A) 1.01mA to 50mA: \pm (0.2% of S.V. +25 μ A)
	Follow voltage	Max. 35V
Extrusion test voltage	Output range	-10V to +20V
	Accuracy	\pm (2% of S.V. +20mV)
Oven	Temperature range	+65 to +400°C
	Temperature fluctuation	\pm 0.5°C (+65 to +350°C)
	Temperature uniformity	\pm 2.5°C (+65 to +350°C)
	Accessories	N ₂ gas inlet

SYSTEM VARIATION

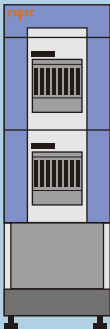
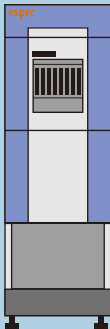
Model		AEM-240C3 AAA	AEM-160C2 0AA	AEM-080C1 00A
EM module output current	Oven 1	50mA	50mA	50mA
	Oven 2	50mA	50mA	—
	Oven 3	50mA	—	—
Number of test channels		240ch	160ch	80ch
DUT board	Number of board	24 (8×3 Ovens)	16 (8×2 Ovens)	8 (8×1 Oven)
	IC sockets	5 docket/ board (both DIP 28-pin 600 mil and DIP 28-pin 300 mil)		
Power supply	Cabinet	200V AC 3 ϕ 50/60Hz		
	PC unit	100V AC 3 ϕ 50/60Hz		
Power consumption	Cabinet	Max. 10kW	Max. 7kW	Max. 4kW
	PC unit	350W		
Cabinet dimensions (mm)		W580×D1220×H1945	W580×D1220×H1490	
PC-rack dimensions (mm)		W680×D640×H1260		
Oven configuration				



DANGER

Do not use specimens which are explosive or inflammable, or which contain such substances. To do so could be hazardous, as this may lead to fire or explosion.



CAUTION

Vapor from specimens that accumulates in tanks or exhaust ducts may ignite and cause fires, so the equipment must be cleaned periodically. Vapor that seeps into and accumulates in equipment insulating layers may cause more serious fires.

SYSTEM BLOCK DIAGRAM

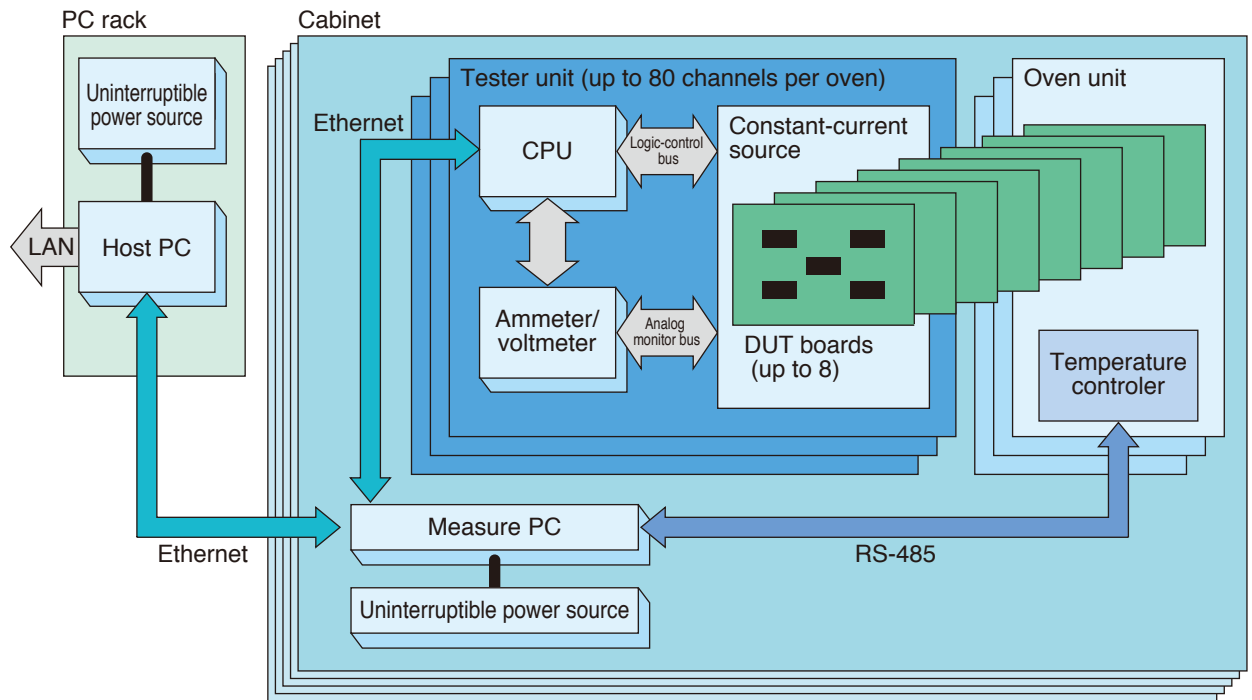

● PC rack

- Host PC
OS: Windows® XP
Test setting, test monitor control and data analysis
- Uninterruptible power source
Backup power supply for host PC

● Cabinet

- Tester unit
One constant-current-source supplies per channel which provided for the unit controlling the DUT power supply and DUT resistance measurement
- Measure PC
Collects measured data and controls measurements
- Uninterruptible power source
Backup power supply for measure PC
- Oven
Temperature control range: +65 to +400°C

ACCESSORIES

- DUT boards (8 per oven)
- Dummy DUT boards (4 per oven)
- Setup CD
- User's manual

SAFETY DEVICES

- Leakage breaker
- Upper and lower temperature limit alarms
- Sensor burn-out detection circuit
- Overheat protector (independent type)
- Overheat protector (built inside)
- Emergency stop switch

OPTIONS

- DUT board
 - for +400°C (DIP28-pin 600/300mil)
 - for +250°C (DIP28-pin 600mil)
 - for +250°C (DIP16-pin 300mil)
- Dumper board
- Dummy DUT board
- Resistance check board
- DUT boards safekeeping rack
- Additional statistical processing software licenses
- Spaire parts kit1
- Spaire parts kit2
- Host PC less
- Temperature recorder
- Paperless recorder (outside installation type)

ESPEC CORP. <http://www.espec.co.jp/english>

Head Office

3-5-6, Tenjinbashi, Kita-ku, Osaka 530-8550, Japan
Tel: 81-6-6358-4741 Fax: 81-6-6358-5500

ESPEC NORTH AMERICA, INC.

Tel: 1-616-896-6100 Fax: 1-616-896-6150

ESPEC EUROPE GmbH

Tel: 49-89-1893-9630 Fax: 49-89-1893-96379

ESPEC ENVIRONMENTAL EQUIPMENT (SHANGHAI) CO., LTD.

Head Office

Tel: 86-21-51036677 Fax: 86-21-63372237

BEIJING Branch

Tel: 86-10-64627025 Fax: 86-10-64627036

TIANJIN Branch

Tel: 86-22-26210366 Fax: 86-22-26282186

GUANGZHOU Branch

Tel: 86-20-83317826 Fax: 86-20-83317825

SHENZHEN Branch

Tel: 86-755-83674422 Fax: 86-755-83674228

SUZHOU Branch

Tel: 86-512-68028890 Fax: 86-512-68028860

ESPEC TEST TECHNOLOGY (SHANGHAI) CO., LTD.

Tel: 86-21-68798008 Fax: 86-21-68798088

ESPEC (MALAYSIA) SDN. BHD.

Tel: 60-3-8945-1377 Fax: 60-3-8945-1287



ISO 9001/JIS Q 9001
Quality Management System Assessed
and Registered

ESPEC CORP. has been assessed by and registered in the Quality Management System based on the International Standard ISO 9001:2008 (JIS Q 9001:2008) through the Japanese Standards Association (JSA).



ISO 14001 (JIS Q 14001)
Environmental Management System Assessed and Registered
ESPEC CORP.

●Specifications are subject to change without notice due to design improvements.

●Windows® is a trademark or registered trademark of Microsoft Corporation in the U.S.A. and other countries. Other corporate names and trade names mentioned in this catalog are trademarks or registered trademarks.