

"Overview of the Orion Vibroacoustic Test Capability at NASA Glenn Research Center"

In order to support the environmental test needs for our new Orion and Constellation program, NASA is developing unique world-class test facilities. To optimize this testing of spaceflight hardware while minimizing transportation issues, a one-stop, under one roof test capability is being developed at the Space Power Facility at the NASA Glenn Research Center's Plum Brook Station. This facility will provide the capability to perform the following environmental testing: (1) reverberation acoustic testing, (2) mechanical base-shake sine testing, (3) modal testing, (4) thermal-vacuum testing, and (5) EMI/EMC (electromagnetic interference and compatibility) testing. An overview of this test capability will be provided in this presentation, with special focus on the two new vibroacoustic test facilities currently being designed and built, the Reverberant Acoustic Test Facility (RATF) and the Mechanical Vibration Facility (MVF). Testing of the engineering developmental hardware and qualification hardware of the Orion (Crew Exploration Vehicle) will commence shortly after the facilities are commissioned.

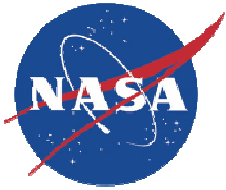

Overview of the Orion Vibroacoustic Test Capability at NASA Glenn Research Center

Presented by:

William O. Hughes, Aron D. Hozman,
Mark E. McNelis and Kim D. Otten

NASA Glenn Research Center

William.O.Hughes@nasa.gov



May 7, 2008



Components of NASA's Constellation Program

Earth Departure Stage

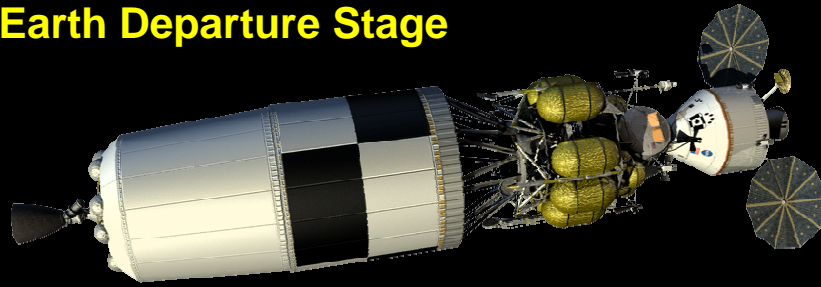

**Orion - Crew
Exploration Vehicle**

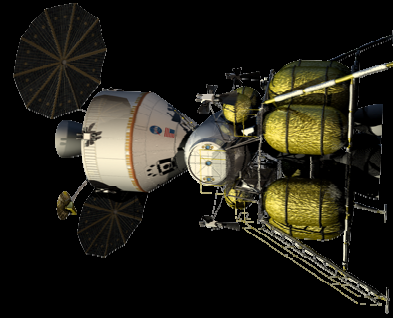

**Heavy Lift
Launch Vehicle**

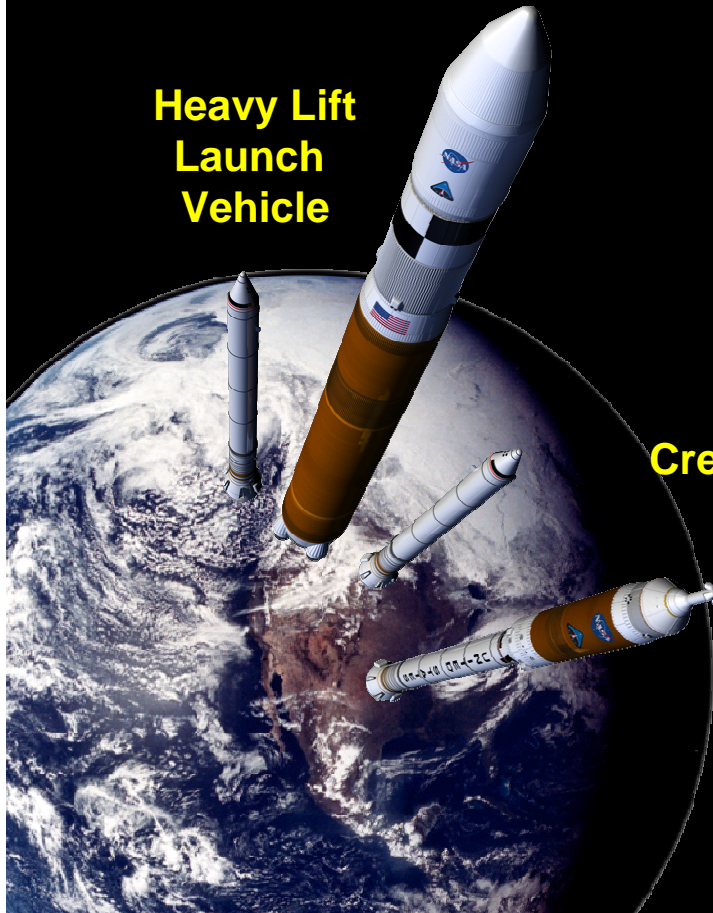

Crew Launch Vehicle

**Altair - Lunar
Lander**



Orion System Elements

Crew Exploration Vehicles (CEV) consists of four functional modules

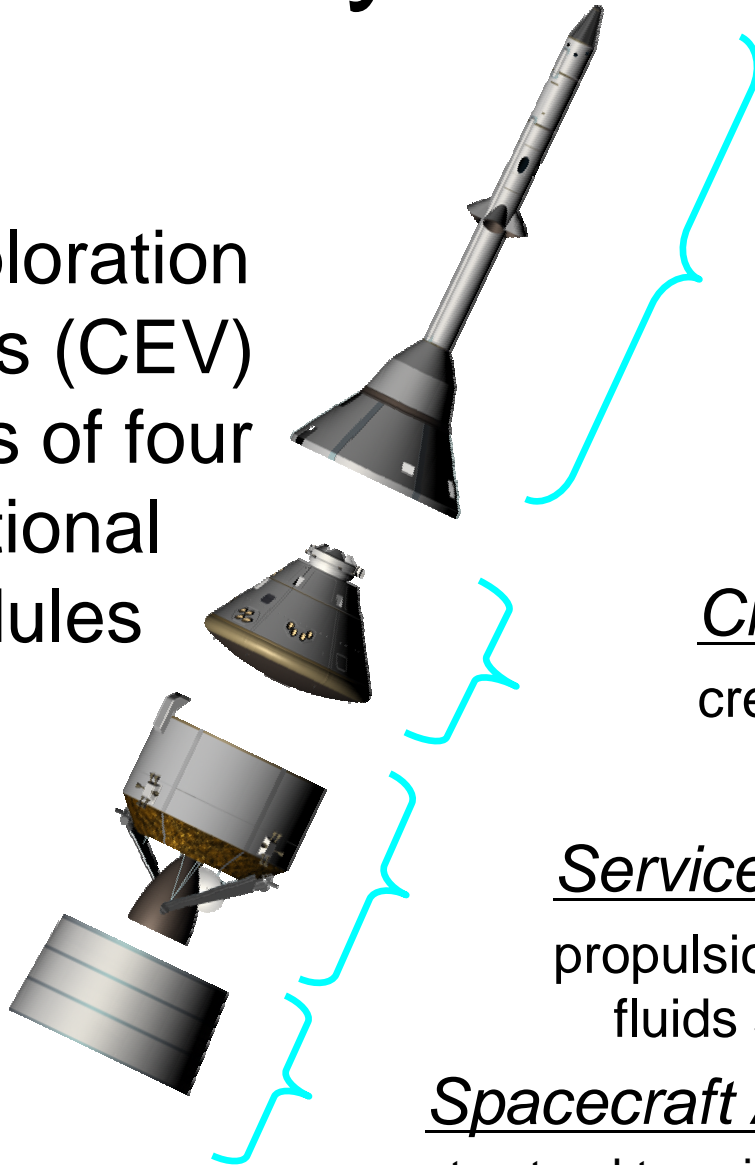

Launch Abort System

emergency escape during launch

Crew Module

crew and cargo transport

Service Module

propulsion, electrical power, fluids storage

Spacecraft Adapter

structural transition to launch vehicle

Test Facility Overview

- The Space Power Facility at the NASA Glenn Plum Brook Station in Sandusky, OH is developing an environmental test capability for the NASA Constellation Program, and the Orion Crew Exploration Vehicle (CEV).
- The CEV is part of the next generation of manned space flight vehicles being developed for return to the Moon and for Mars.
- Testing will be conducted on the Ground Test Article (GTA) and Qualification Test Article in a “test as you fly” configuration.

Environmental Facility Capability:

- Acoustic Vibration
- Mechanical Vibration
- Modal
- Thermal-Vacuum
- EMI/EMC

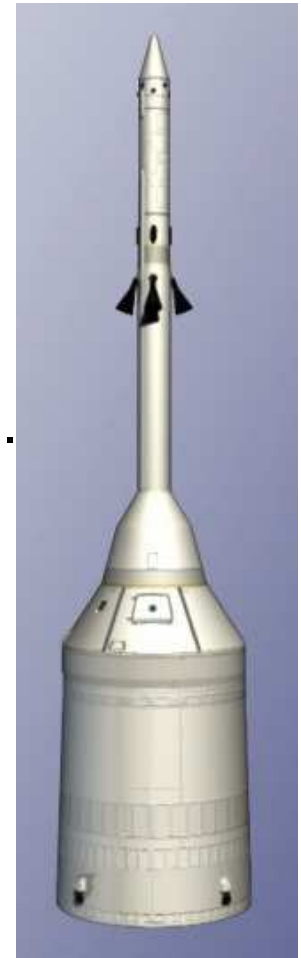

**Crew
Exploration
Vehicle**



Plum Brook Station

Sandusky, Ohio

NASA Glenn Research Center

Space Power Facility (SPF)

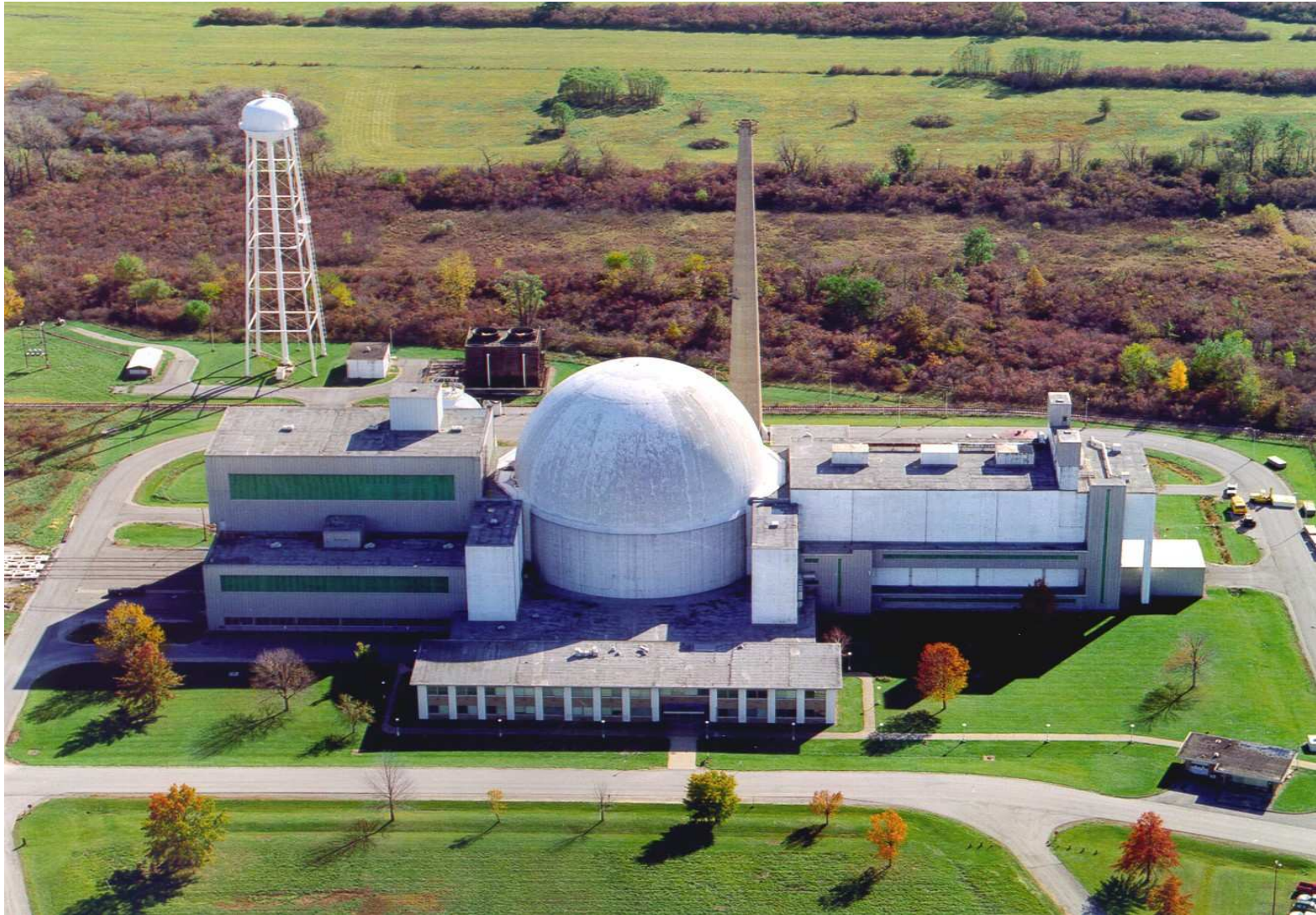

Space Environmental Testing Under One Roof

- Maintain thermal vacuum test capability of SPF.
- Incorporate EMI/EMC testing within vacuum test chamber.
- Design and build two new vibroacoustic test capabilities within disassembly (west) area of SPF Facility
 - Mechanical Vibration Facility (MVF) (sine and modal)
 - Reverberant Acoustic Test Facility (RATF)
- Vibroacoustic facilities required to be commissioned (verification testing successfully completed) by July 2009

Provide Orion Critical Path Testing and Support Future Constellation Testing

Perform modifications to the Space Power Facility for:

- Acoustic Vibration
- Mechanical Vibration
- Modal
- Thermal-Vacuum
- EMI/EMC

Ensure Mechanical and Acoustic Vibration Facilities capabilities meet CEV Testing requirements and do not preclude future Constellation element testing

Conceptual Drawing

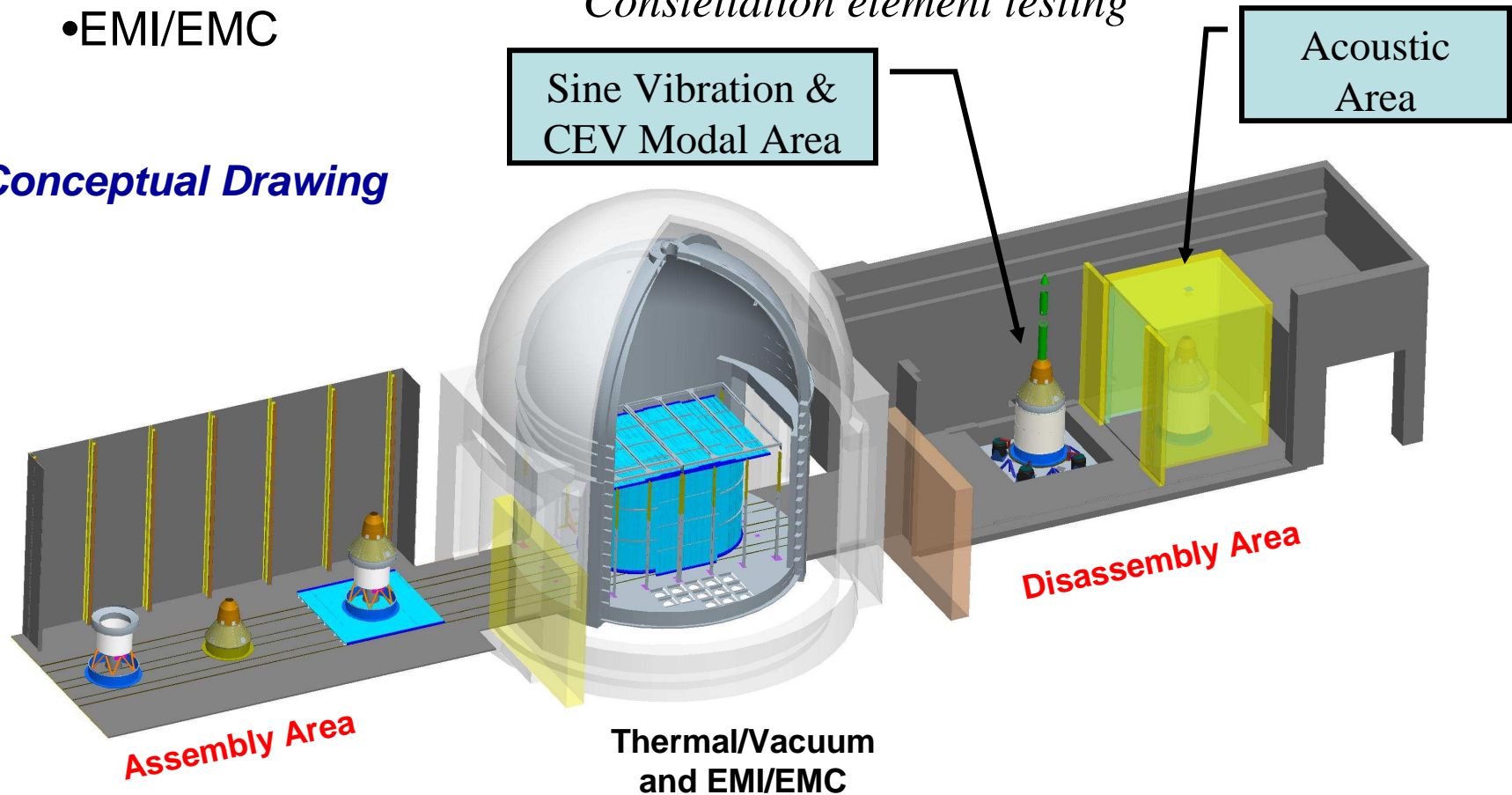

Thermal Vacuum & EMI/EMC

Thermal Vacuum

- Vacuum to 10⁻⁶ torr; 100 ft Diameter, 122 ft Height
- Thermal simulation: -200 F to 175 F
 - GN2-cooled Cryoshroud
 - 2 new ceiling cryogenic panels (1700 ft² total)
 - Modify cryoshroud suspension structure and refurbish existing cryoshroud panels.
 - Thermal heat flux simulation (14 zones, 480 V)
 - 1 sun thermal heat flux
 - Phase angle power supply controllers
 - 14 zones, 400 kW/zone

EMI/EMC

- All tests are performed inside the aluminum vacuum chamber using the chamber as an RF shield
 - Unwanted, external signals stay outside test chamber
 - Signals generated for tests remain inside test chamber
- Suspended, moveable equipment platforms provide direct, localized RF illumination of the vehicle
- Radiated susceptibility and shielding effectiveness testing at frequencies up to 35 GHz

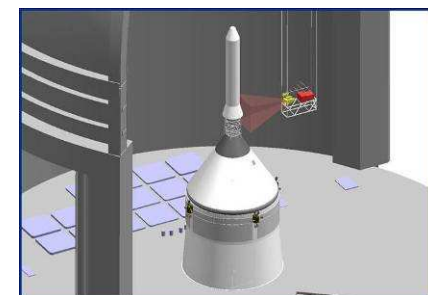
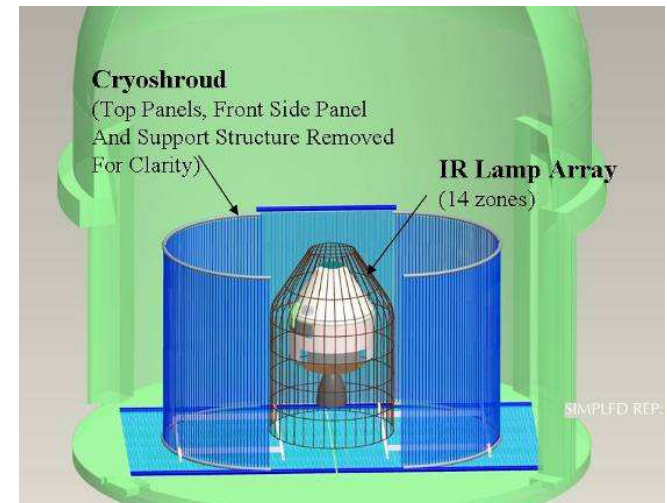
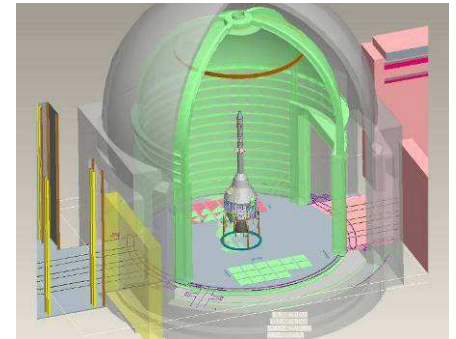

Major Area for Facility Upgrades

Vibration Test Area

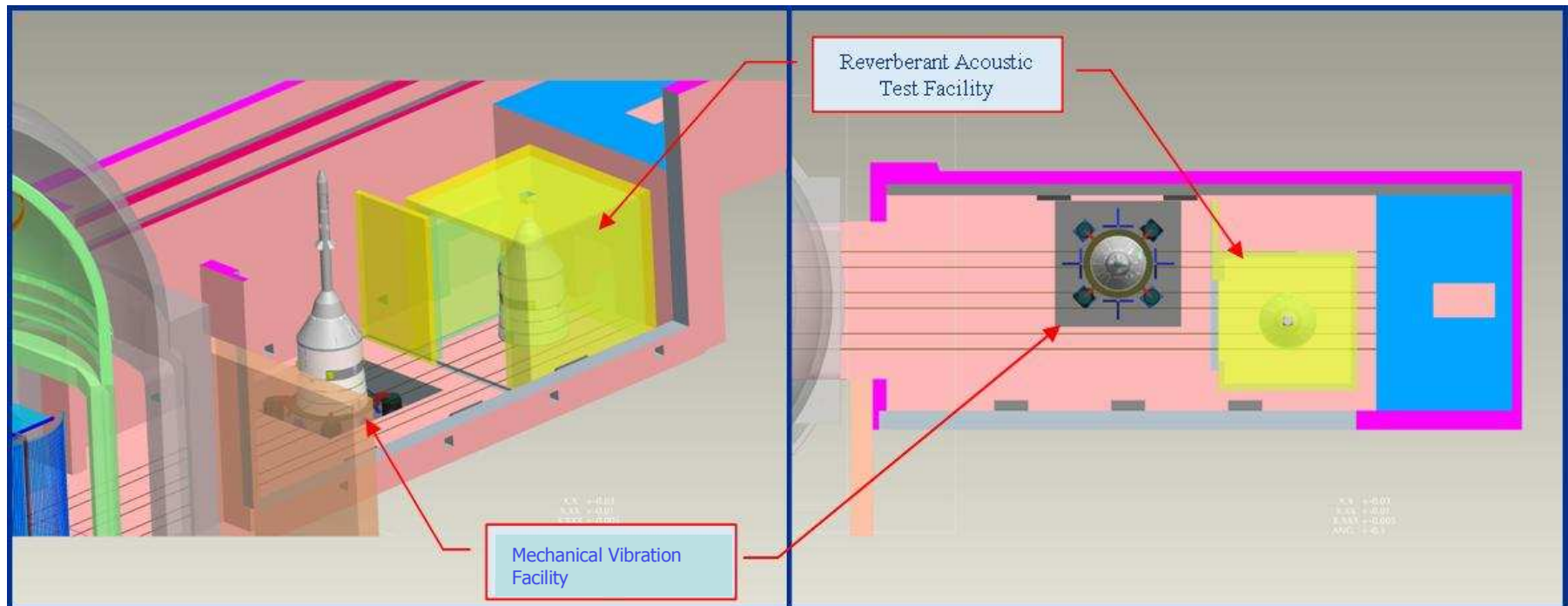

Conceptual Drawing

Vibro-Acoustic Test Capability (VTC)

Technical Requirements Highlights

- Mechanical Vibration Facility (MVF)
 - Single axis sine vibration (vertical, lateral)
 - CEV test article: 75,000 lb, 75 ft height, 18 ft diameter
 - Design for Overturning Moment of CEV
 - Change axis of input motion without removing the test article
 - Seismic mass to accommodate 120,000 lbm test article for modal
- Reverberant Acoustic Test Facility (RATF)
 - 163 dB OASPL (empty chamber)
 - 20 minute continuous run times
 - Designed for 47 ft tall x 20 ft diameter (CEV elements with margin)
 - Accommodates Altair - Lunar Lander (32.8 ft diameter)
- High-Speed Data Acquisition System (HSDAS)
 - 1024 channels dynamic data
 - Acceleration, pressure, strain, temperature
 - Support both MVF and RATF needs

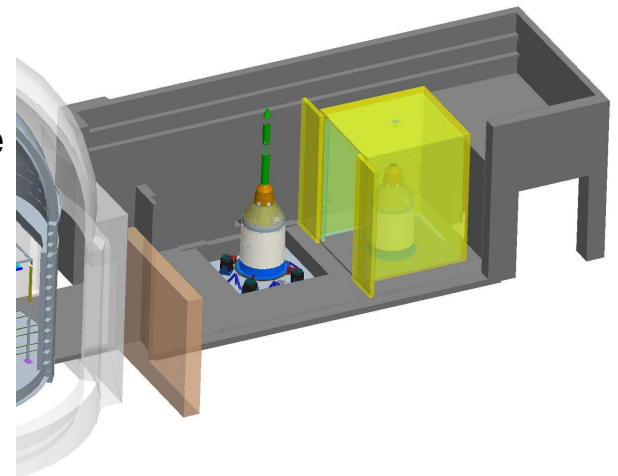

Conceptual Drawing

Reverberant Acoustic Test Facility (RATF)

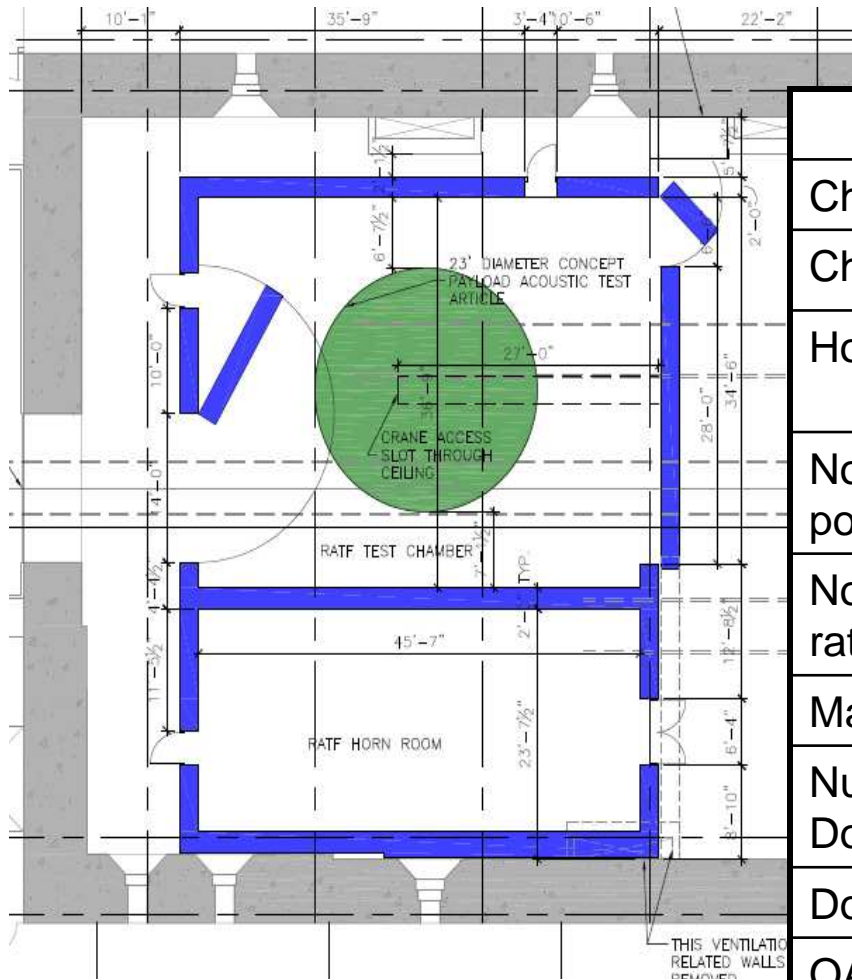

	Chamber Properties
Chamber Size	47.5 ft L x 37.5 ft W x 57 ft H
Chamber Volume	101,189 ft ³
Horns/Modulators	23 High Power Modulators and 23 Horns *
Nominal acoustic power installed	4,000 kW *
Nominal GN ₂ flow rate	84,000 scfm *
Main Door Opening	34.5 ft wide
Number of Main Doors	2
Door Type	Sliding and hinged
OASPL, empty	163 dB OASPL

* Subject to design changes

Reverberant Acoustic Test Facility (RATF)

RATF Proposed SOW Updates - Rev 6

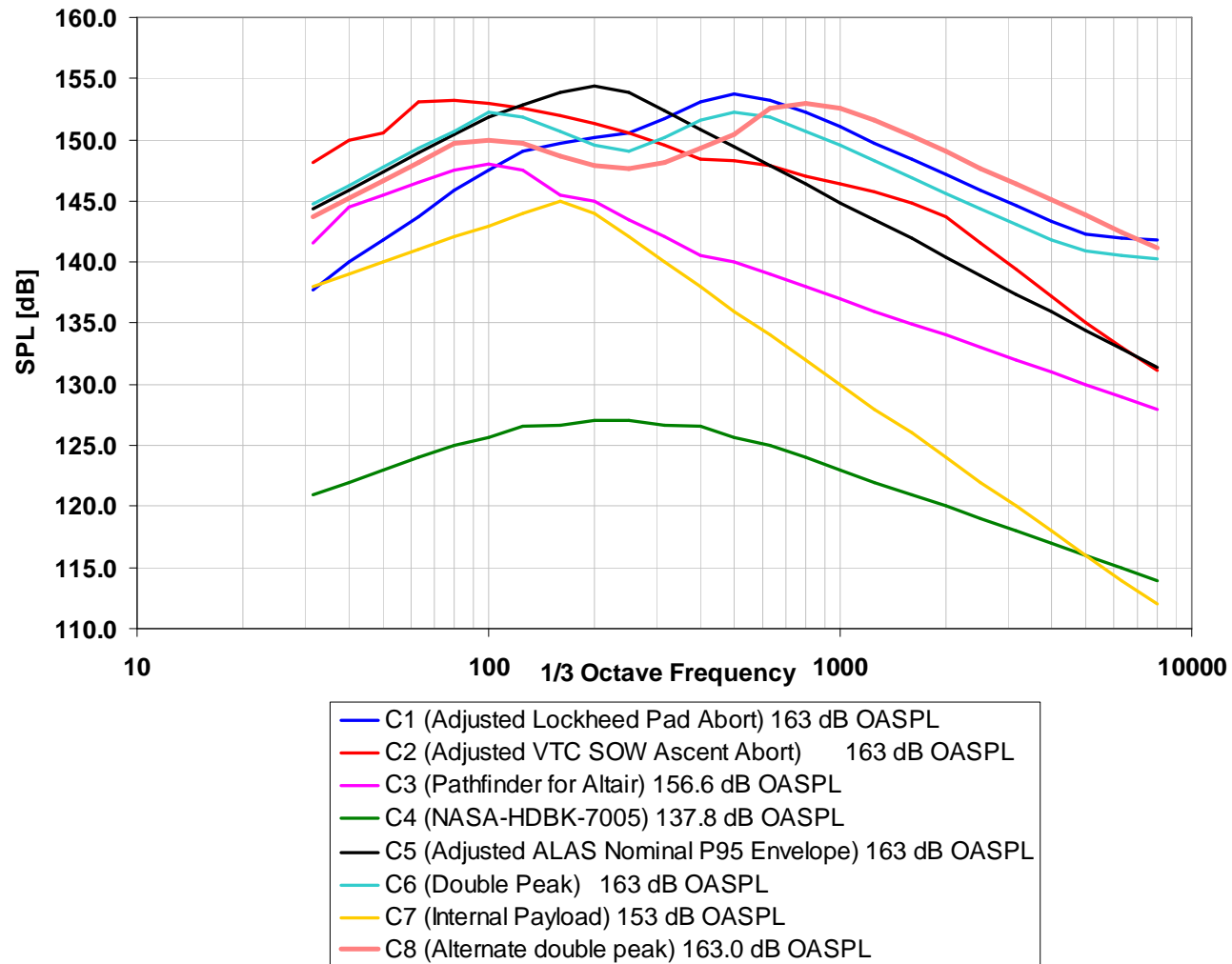

Mechanical Vibration Facility (MVF)

- Low-frequency (servo-hydraulic) sinusoidal vibration system

Vertical: 0 to 1.25-g's;
5 to 150-Hz;
Sine sweep up
to 4 octaves/min

Horizontal: 0 to 1.0-g's;
5 to 150-Hz;
Sine sweep
up to 4 octaves/min

- 3 single axis test capability of CEV Full Stack; Change axis of input motion without removing the test article
- Table surface below grade to accommodate test article height

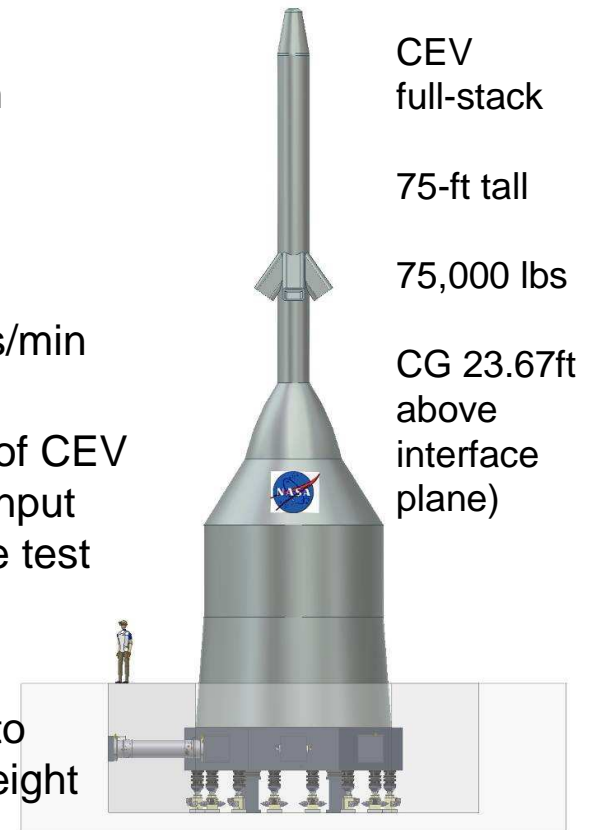
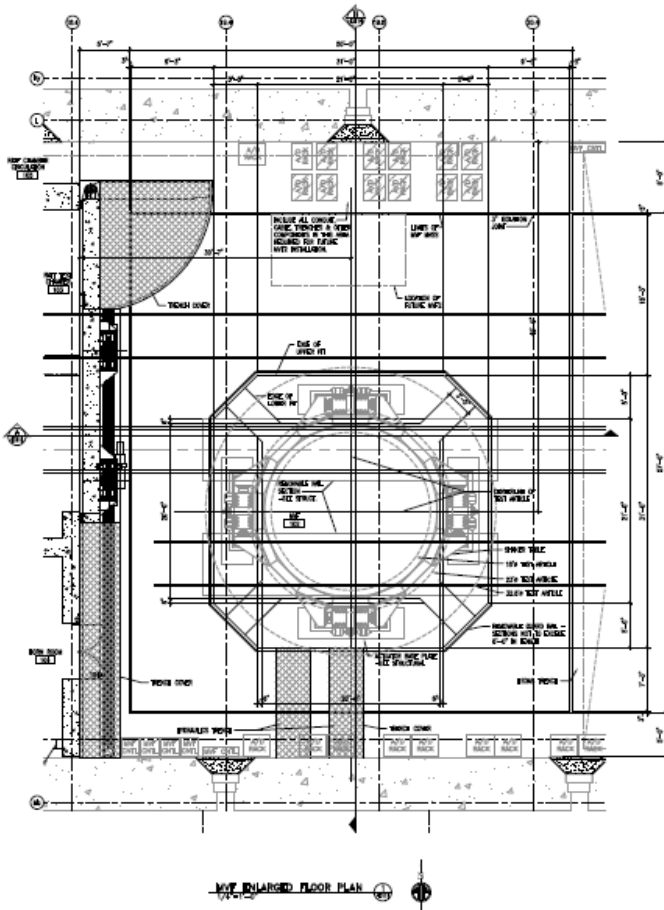

MVF Facility Layout

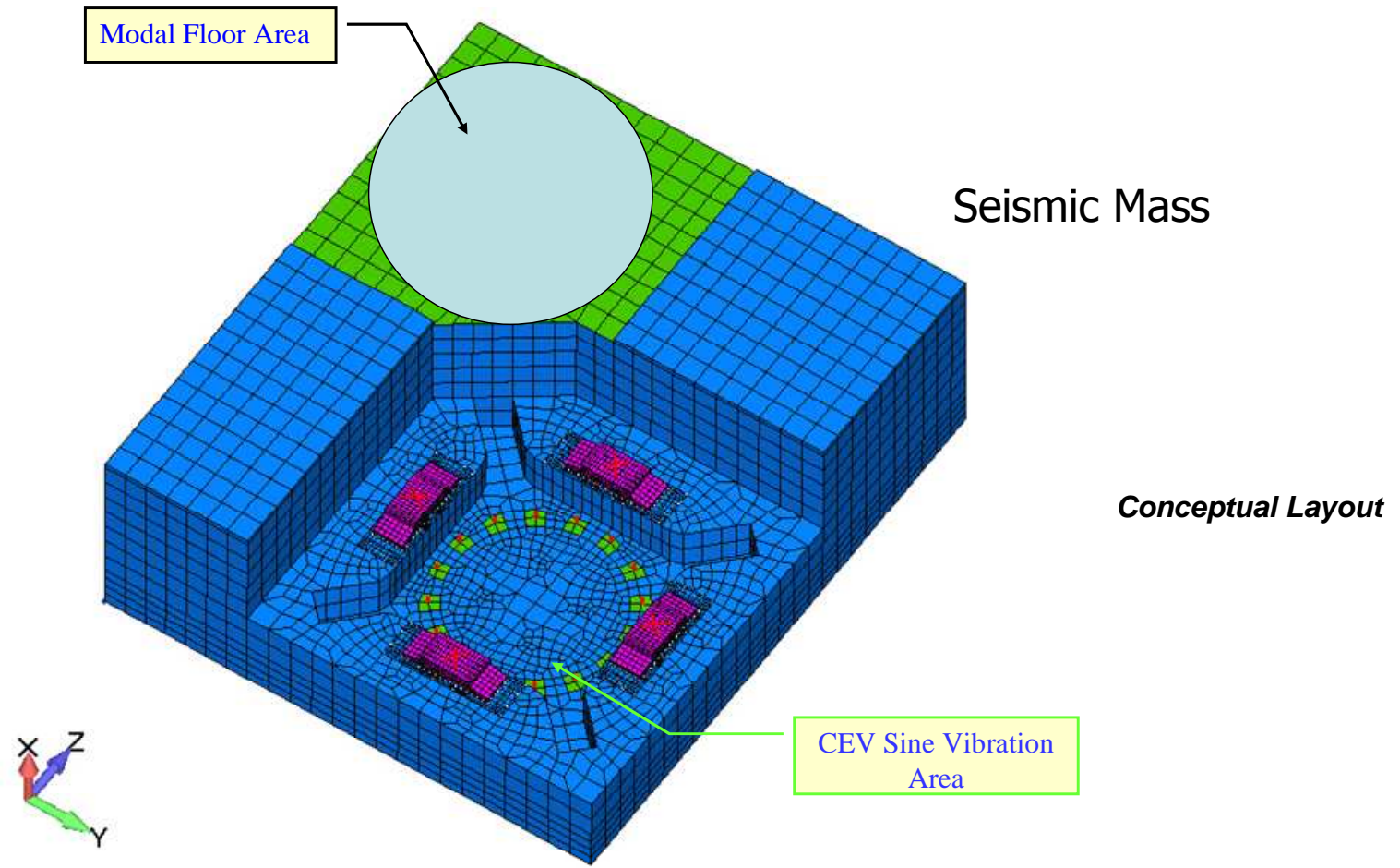

Vibration System

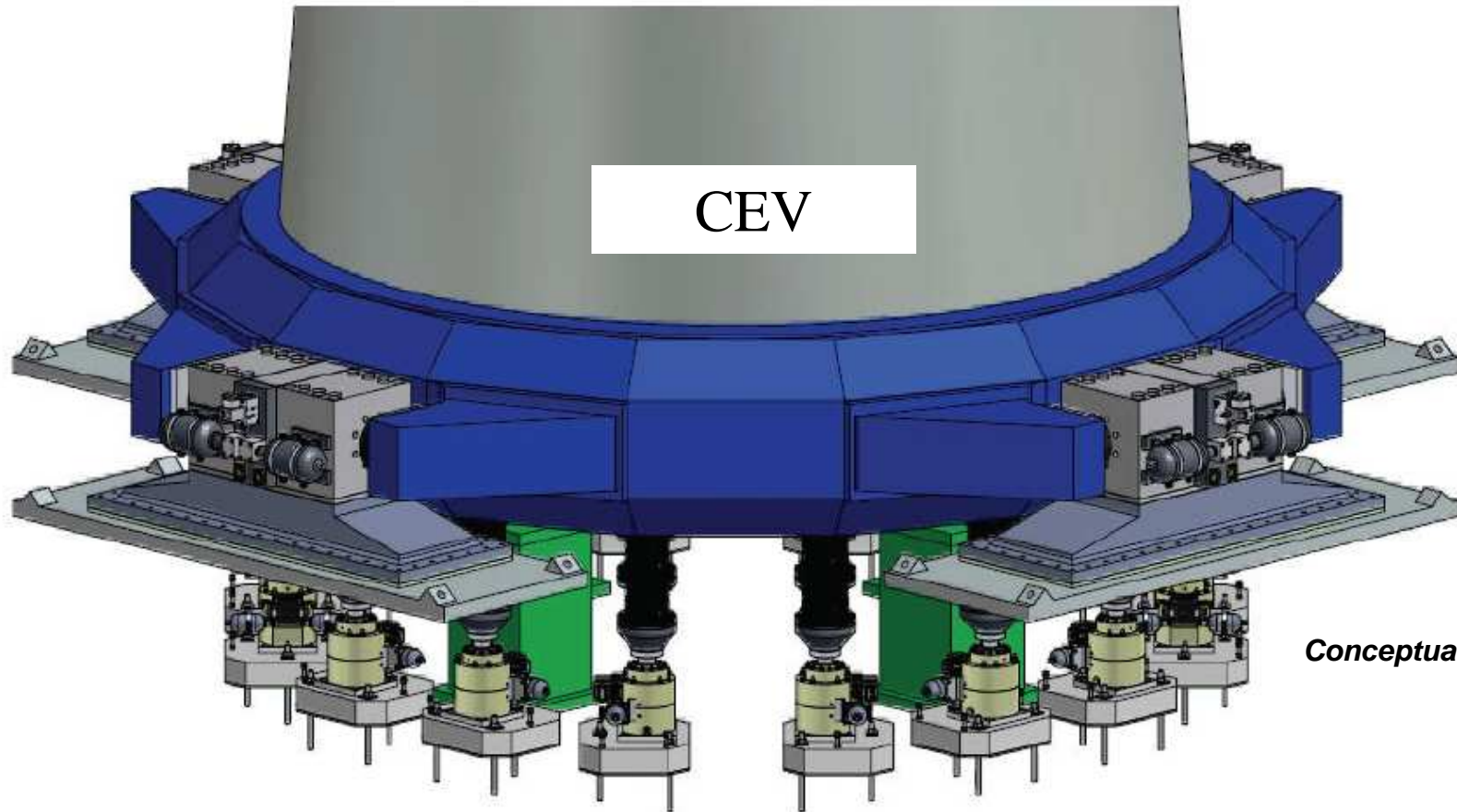

Conceptual Layout

16 Vertical, 4 Horizontal exciters give full 6 DOF Vibration Table

High Speed Data Acquisition System (HSDAS)

COTS Data Acquisition proposed

- Open hardware and software architecture
- Real-time displays
- Simultaneous data acquisition and access
- Scalable/Reconfigurable
 - 1024 Channels
 - Expansion to provide 1536 channels
- Supports MVF and RATF

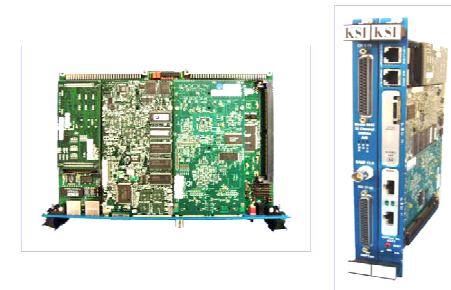
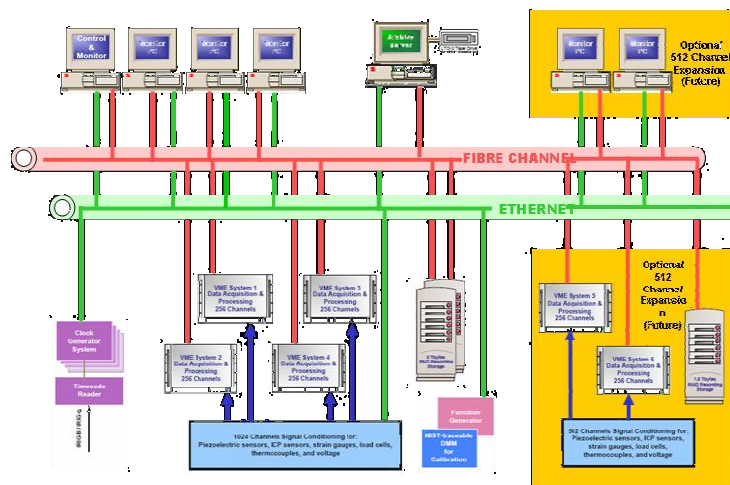

Construction Status

- Construction mobilization continues in parallel with demolition
- Installed Thermal/Vacuum Chamber barrier
- Completed geo-probe samples and analyses - received approval to remove soil
- Floor demolition complete
- Hot cell demolition completed by end of December 2007
- MVF excavation started January 2008 (19 ft deep; 56.6 ft by 49.5 ft)



Construction Status

- Current RATF Foundation Status:
 - RATF foundation excavation has been completed.
 - RATF foundation construction started April 2008.



CEV Test Schedule

Test Article	Test Begins	Test Completion
Ground Test Article (GTA)	September 2009	April 2010
Qualification	May 2011	June 2012

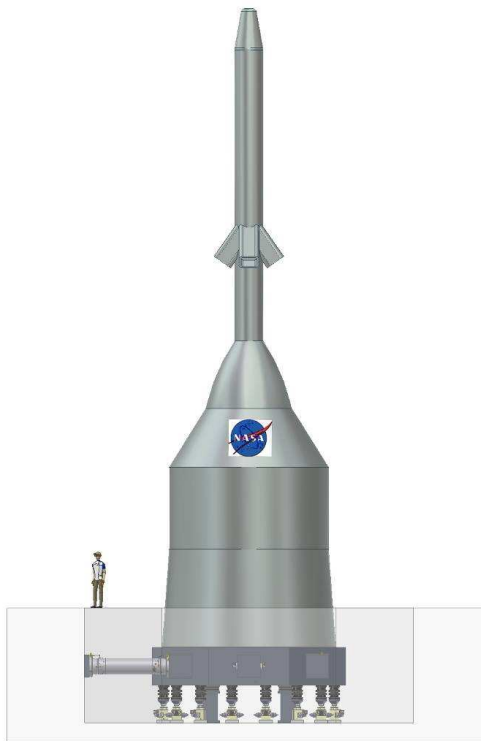

Summary

- Orion Integrated Environmental Testing Project provides one-stop testing under one roof at the NASA Glenn Plum Brook Station.
- NASA will have World Class Facilities available to support Constellation Architectural elements environmental testing needs:
 - Acoustic Vibration
 - Mechanical Vibration
 - Modal
 - Thermal Vacuum
 - EMI/EMC
- Facilities will support the spaceflight testing required for the development (GTA) and qualification of the Orion CEV hardware.

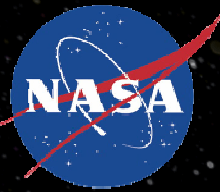

Contact Information:

William O. Hughes

NASA Glenn Research Center

William.O.Hughes@nasa.gov

