

SUN-IP  
**ELBAG**

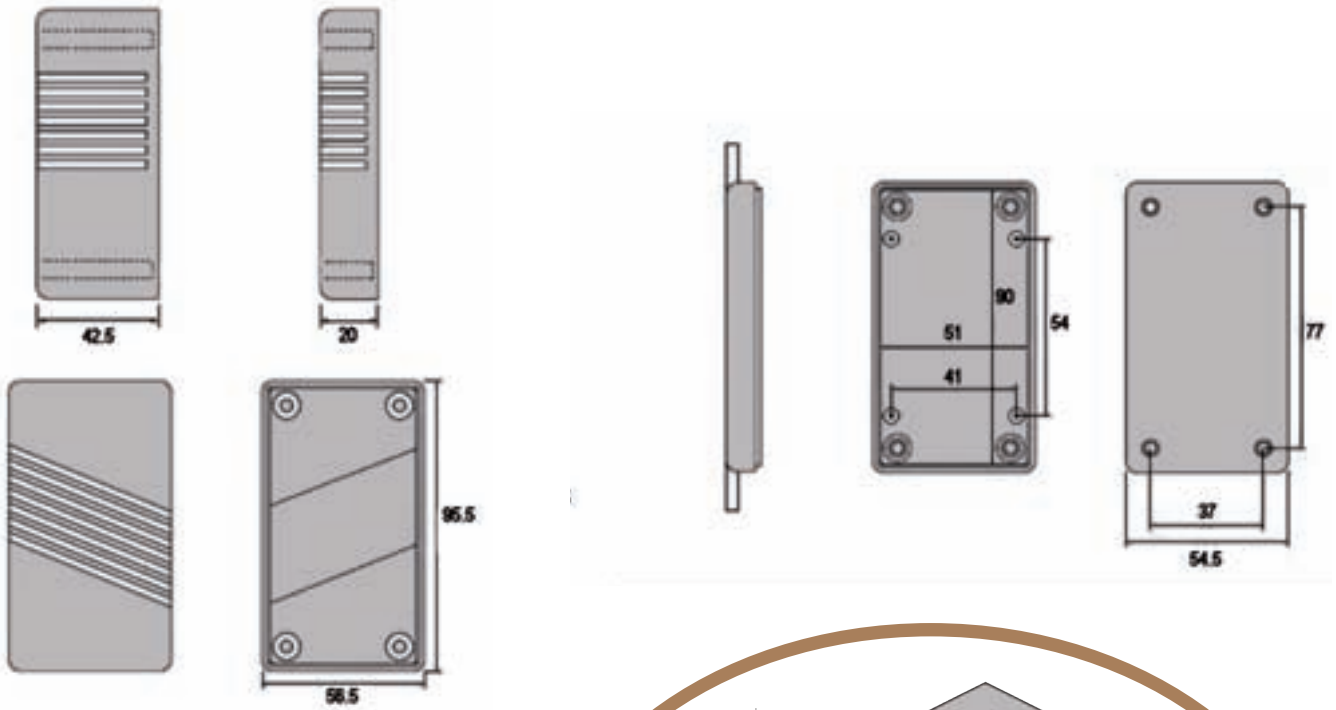

POWER BOX - ALIMENTATORI 57

96.56



DISEGNI TECNICI SU: [www.elbag.net](http://www.elbag.net)  
TECHNICAL DRAWINGS ON:

120.65

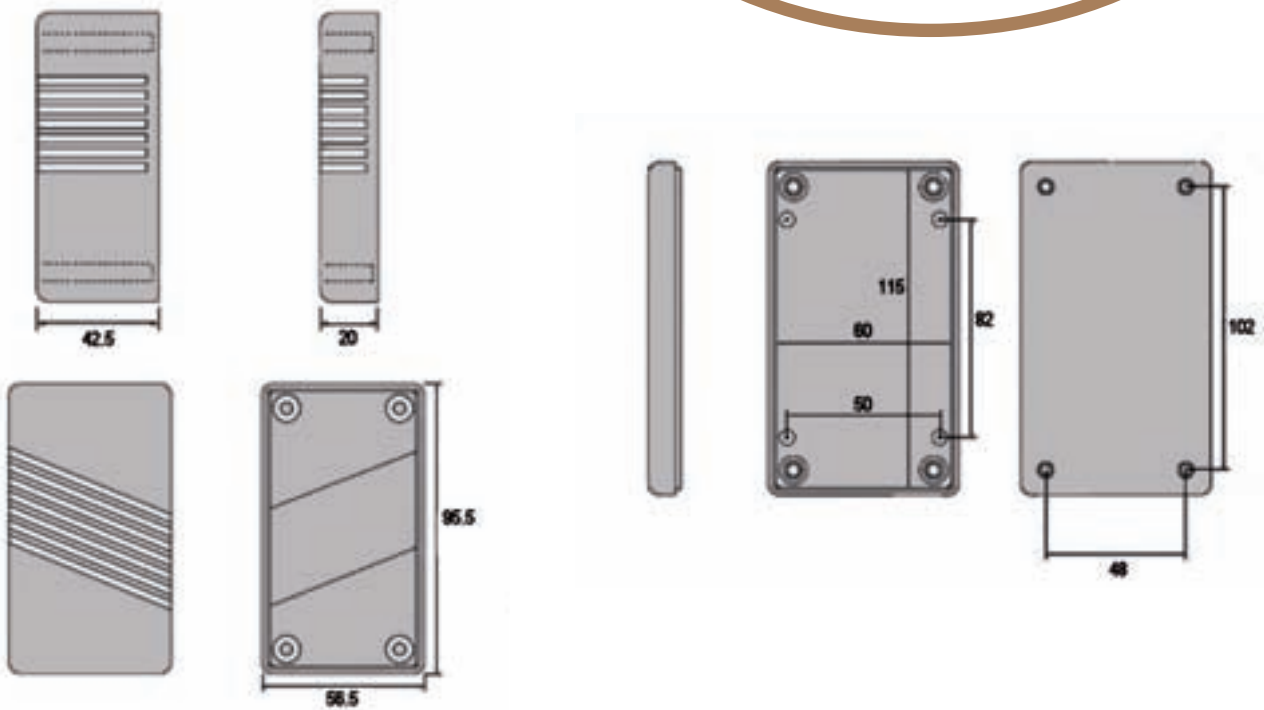

### SERIE 96.56 - COPERCHI

I coperchi serie 96.56 possono essere aerati, ventilati, forati per altoparlante/sensore, lisci, con alloggiamento per multipresa USA/EUROPA/SCHUKO, o lavorati a disegno.

### 96.56 SERIES - COVERS

The cover 96.56 can be vented, bored for loudspeaker/sensor, smooth, with multisolet USA/EURO/SCHUKO, or custom worked.

DISEGNI TECNICI SU: [www.elbag.net](http://www.elbag.net)  
TECHNICAL DRAWINGS ON:

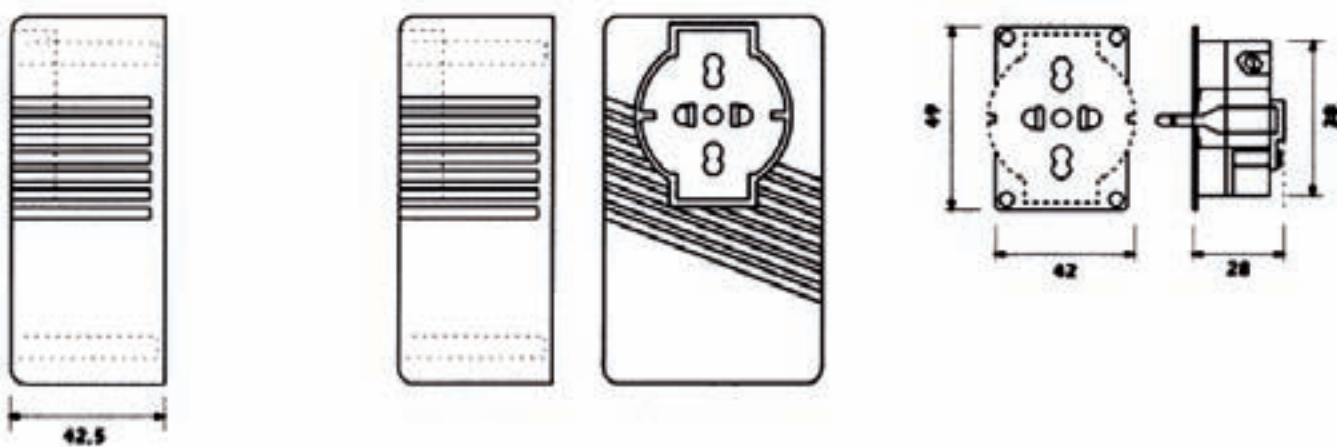
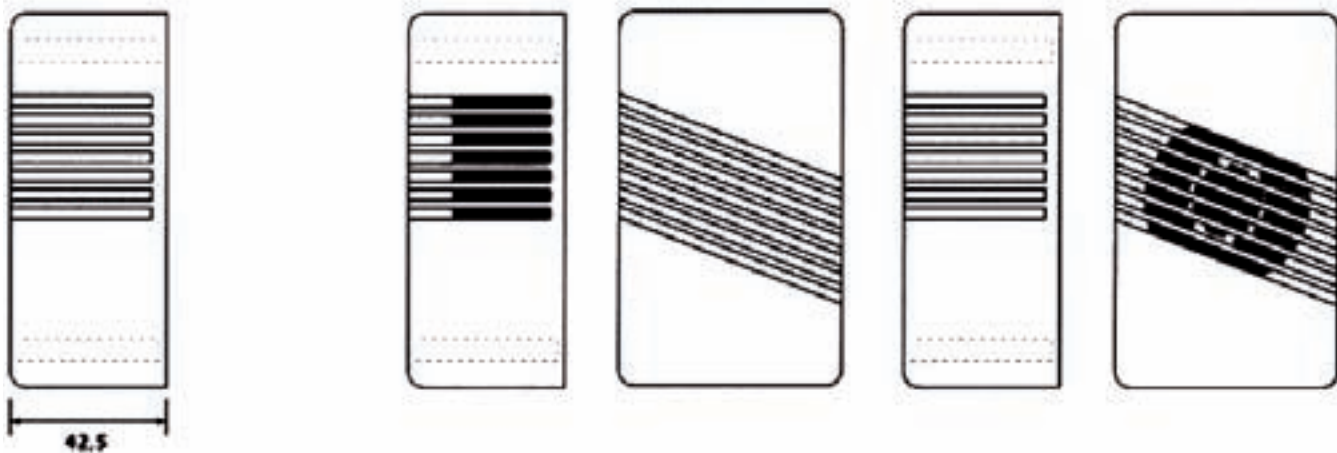
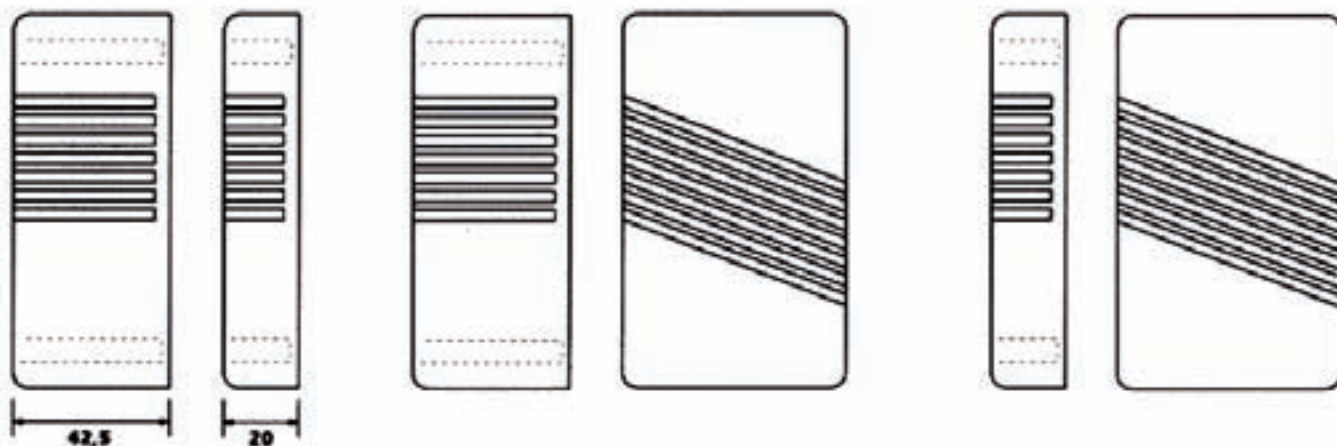



### SERIE 96.56 - BASI

Le basi 96.56 possono essere cieche o con un gran numero di spine con o senza terra, che coprono tutti gli standard più comuni in Europa. La base è dotata di quattro torrette di fissaggio per circuito stampato, di due fermacavi e di quattro fori per il fissaggio meccanico a vite.

### 96.56 SERIES - BASES

The bases 96.56 can be delivered blind or with plugs according to the most common standards in Europe. The bases are equipped with four towers for p.c. boards mounting, two cable fasteners and four holes for mechanical mounting.

DISEGNI TECNICI SU: [www.elbag.net](http://www.elbag.net)  
TECHNICAL DRAWINGS ON:

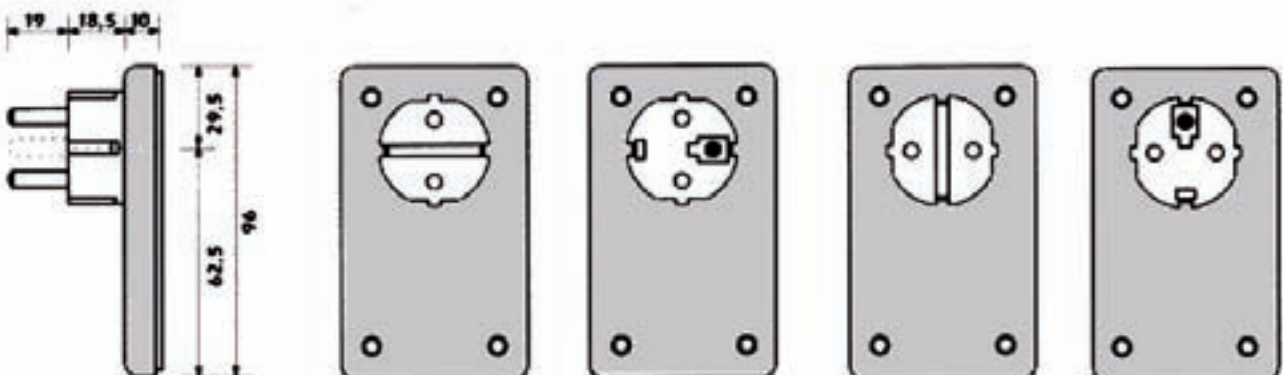
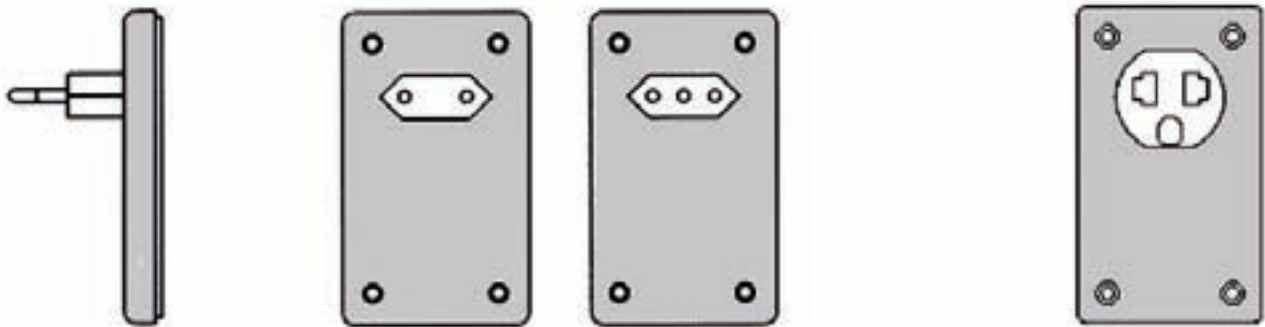
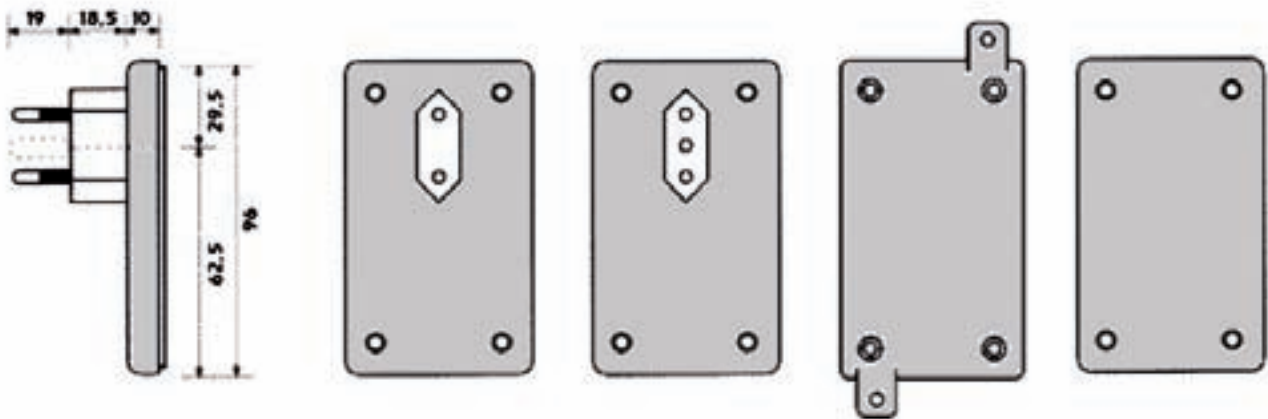

### SERIE 120.65 - COPERCHI

Le calotte 120.65 possono essere chiuse areate e ventilate, forate a disegno e con alloggiamento per multipresa: USA - EUROPA - SCHUKO.

### 120.65 SERIES - COVER

The cover 120.65 can be vented, with custom drilling and with a slot for a mains multi-socket: USA - EUROPE - SCHUKO

DISEGNI TECNICI SU: [www.elbag.net](http://www.elbag.net)  
 TECHNICAL DRAWINGS ON:

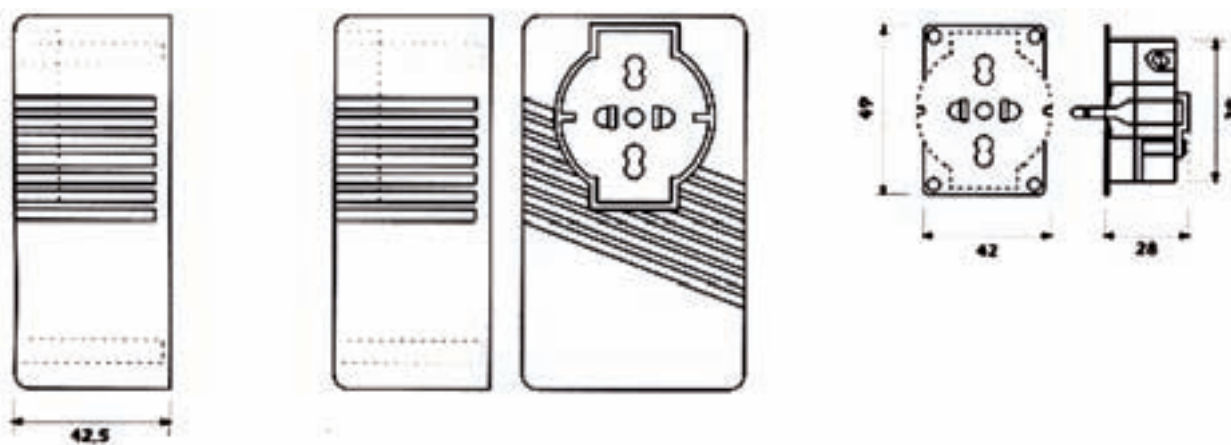
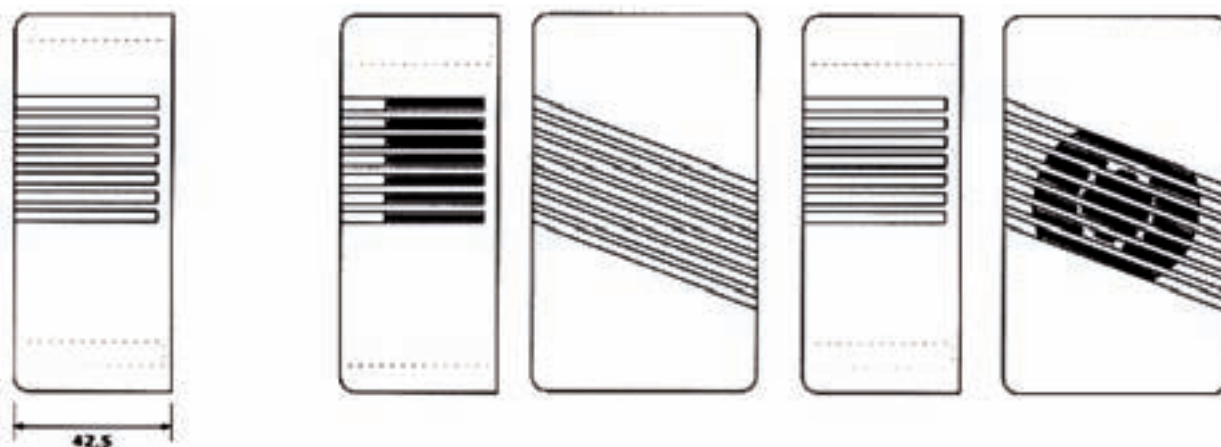
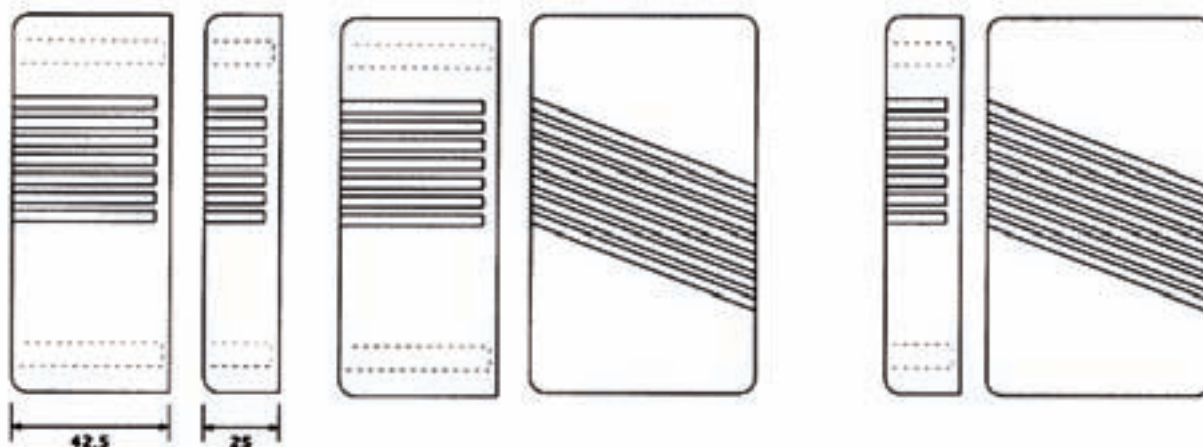



### SERIE 120.65 - BASI

Le basi 120.65 possono essere cieche o con un gran numero di spine, che coprono tutti gli standard più comuni in Europa. La base è dotata di quattro torrette di fissaggio per circuito stampato, di due fermacavi e di quattro fori per il fissaggio meccanico a vite.

### 120.65 SERIES - BASES

The bases 120.65 can be delivered blind or with plugs according to the most common standards in Europe. The bases are equipped with four towers for p.c. boards mounting, two cable fasteners and four holes for mechanical mounting.

DISEGNI TECNICI SU: [www.elbag.net](http://www.elbag.net)  
TECHNICAL DRAWINGS ON:

