

**Insulator material**  
PBT, UL94V-0

**Contact material**  
Phosphor bronze

**Plating**  
Ni, Sn

**Contact resistance**  
20mΩ max

**Insulation resistance**  
5000MΩ min

**Current rating**  
1A

**Operating temperature**  
-25°C - +85°C

**Operating voltage**  
60V AC

**Test voltage**  
1000V AC

**Packing**  
Tube packing

Dimensions			
No. of contacts	A	B	C
06	7.62	10.16	7.62
08	10.16	10.16	7.62
14	17.78	10.16	7.62
16	20.32	10.16	7.62
18	22.86	10.16	7.62
20	25.40	10.16	7.62
24*	30.48	17.78	15.24
24	30.48	10.16	7.62
28	35.56	17.78	15.24
28*	35.56	10.16	7.62
32	40.64	17.78	15.24
40	50.80	17.78	15.24

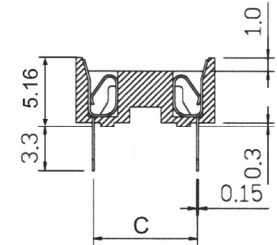
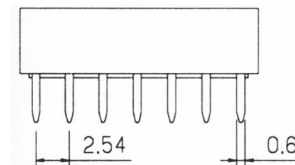
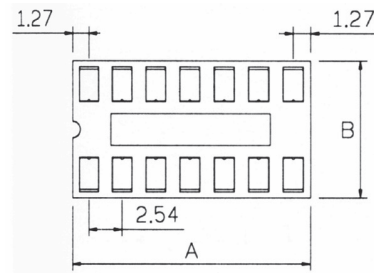

Ordercode

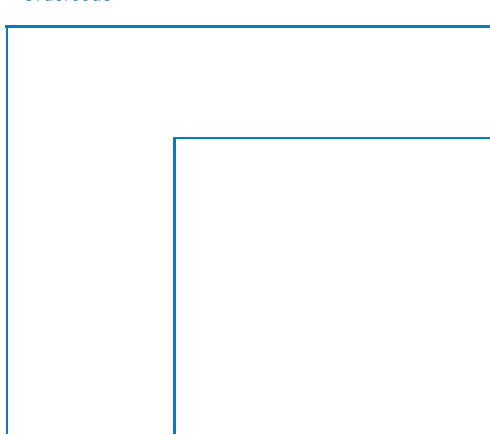

**A** **xx** **LC** **x**

**No. of contacts**

06 / 08 / 14 / 16 / 18 / 20 /  
24 / 28 / 32 / 40

**Version**

-TT - Standard  
/7-T - Pitch 2.54 x 7.62\*  
(only 24 and 28poles)

Please replace „x“ appropriate option

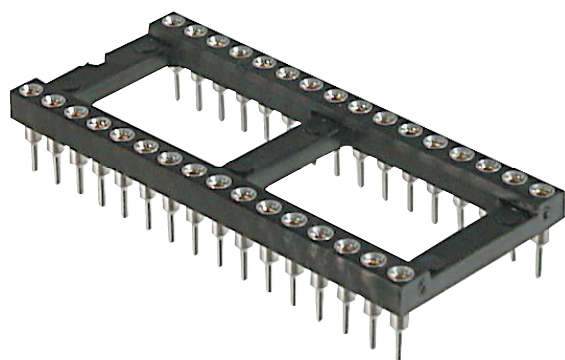

**Insulator material**  
PBT, UL94V-0

**Contact material**  
Sleeve - brass  
Clip - phosphor bronze

**Plating**  
Ni, Au / Sn

**Contact resistance**  
4mΩ max

**Insulation resistance**  
10000MΩ min

**Current rating**  
3A

**Operating temperature**  
-40°C - +105°C

**Operating voltage**  
100V AC

**Test voltage**  
500V AC

**Packing**  
Tube packing

Dimensions				
No. of contacts	A	B	C	D
6	7.62	5.08	7.62	10.16
8	10.16	7.62	7.62	10.16
10	12.70	10.16	7.62	10.16
14	17.78	15.24	7.62	10.16
16	20.32	17.78	7.62	10.16
18	22.86	20.32	7.62	10.16
20	25.40	22.86	7.62	10.16
24	30.48	27.94	15.24	17.78
24*	30.48	27.94	7.62	10.16
28	35.56	33.02	15.24	17.78
28*	35.56	33.02	7.62	10.16
32	40.64	38.1	15.24	17.78
40	50.8	48.26	15.24	17.78

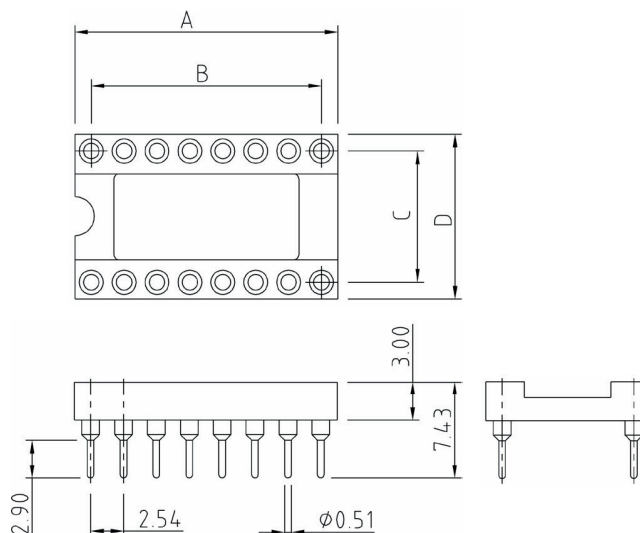

Ordercode

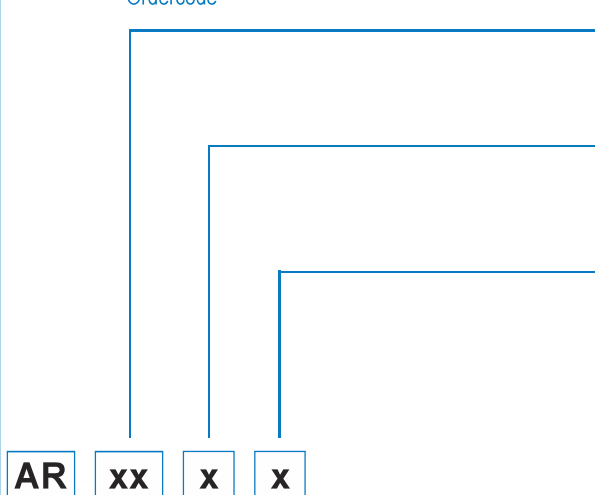

**No. of contacts**  
06 / 08 / 10 / 14 / 16 / 18 / 20 / 24 /  
28 / 32 / 40

**Plating sleeve**  
HZL - Tin\*  
HZL/07 - Tin/ clip 30µ" gold  
HZL/01 - Tin/ clip 10µ" gold

**Versions**  
-TT - Standard  
/7-TT - Only for 24+28-poles\*  
(DIM C: 7.62)

Please replace „x“ appropriate option

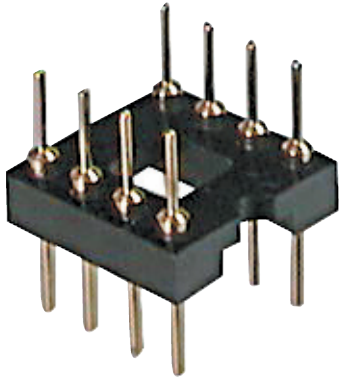

**Insulator material**  
PBT, UL94V-0

**Contact material**  
Brass

**Plating**  
Ni, Au

**Contact resistance**  
4mΩ max

**Insulation resistance**  
10000MΩ min

**Current rating**  
3A

**Operating temperature**  
-55°C - +125°C

**Operating voltage**  
100V AC

**Test voltage**  
500V AC

**Packing**  
Tube packing

Dimensions				
No. of contacts	A	B	C	D
06	7.62	5.08	7.62	10.16
08	10.16	7.62	7.62	10.16
10	12.70	10.16	7.62	10.16
14	17.78	15.24	7.62	10.16
16	20.32	17.78	7.62	10.16
18	22.86	20.32	7.62	10.16
20	25.40	22.86	7.62	10.16
24	30.48	27.94	15.24	17.78
28	35.56	33.02	15.24	17.78
40	50.80	48.26	15.24	17.78

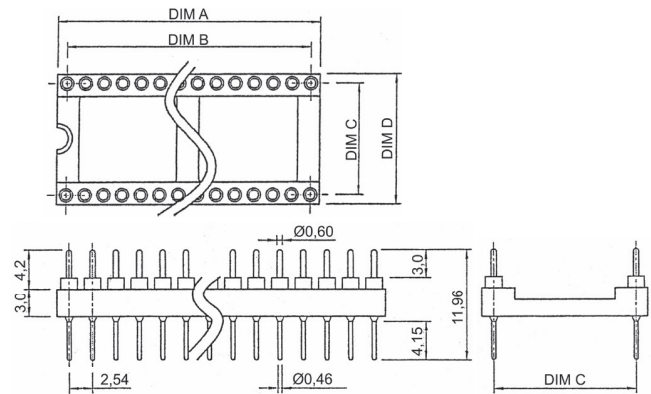
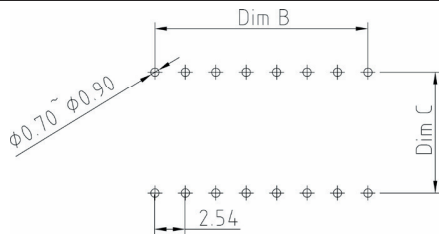

Ordercode

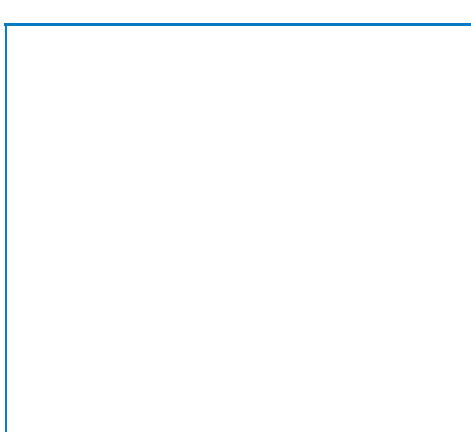

**AR** **xx** **ST** **T**

**No. of contacts**

06 / 08 / 10 / 14 / 16 / 18 / 20 /  
24 / 28 / 40

Please replace „x“ appropriate option

- Insulator material**  
PBT, UL94V-0
- Contact material**  
Phosphor bronze
- Plating**  
Ni, Sn
- Contact resistance**  
15mΩ max
- Insulation resistance**  
10000MΩ min
- Current rating**  
1A
- Operating temperature**  
-40°C - +105°C
- Operating voltage**  
100V AC
- Test voltage**  
500V AC
- Packing**  
Tube packing

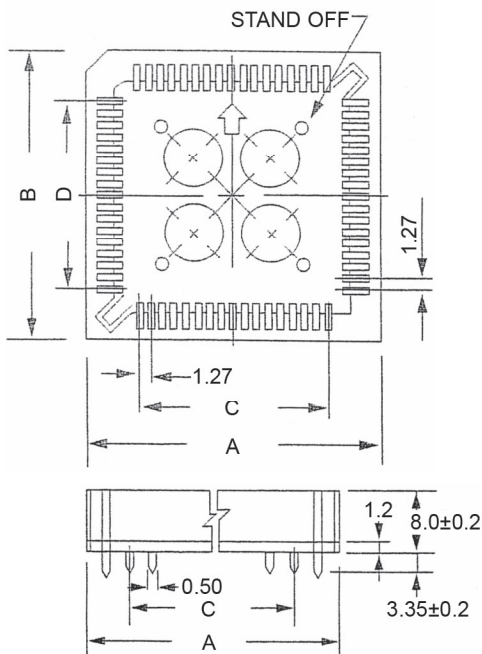
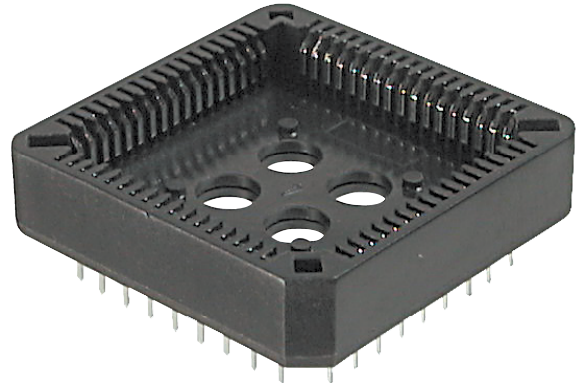

Dimensions			
No. of contacts	A	B	C
20	15.50	15.50	5.08
28	18.05	18.05	7.62
32	18.05	20.60	7.62
44	23.50	23.50	12.70
52	25.88	25.88	15.24
68	31.66	31.66	20.32
84	36.66	36.66	25.40

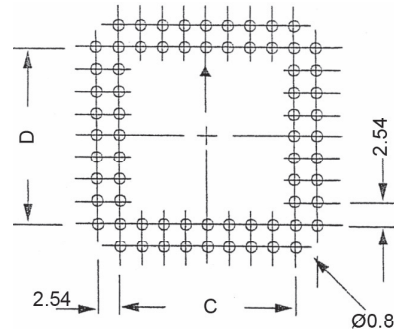

Ordercode

No. of contacts  
20 / 28 / 32 / 44 / 52 / 68 / 84

**A** **CCS** **0** **xx** **Z** **T**

Please replace „x“ appropriate option

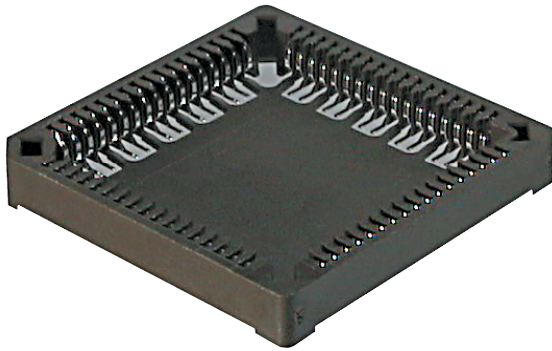

**Insulator material**  
Nylon 9T, UL94V-0

**Contact material**  
Phosphor bronze

**Plating**  
Ni, Sn

**Contact resistance**  
15mΩ max

**Insulation resistance**  
10000MΩ min

**Current rating**  
1A

**Operating temperature**  
-40°C - +105°C

**Operating voltage**  
100V AC

**Test voltage**  
500V AC

**Packing**  
Tube packing

**Dimensions**

No. of contacts	A	B	C	D	E	F
20	15.34	15.34	5.08	5.08	10.03	10.03
28	17.85	17.85	7.62	7.62	12.57	12.57
32	17.85	20.42	7.62	10.16	12.57	15.11
44	23.07	23.07	12.70	12.70	17.65	17.65
52	25.50	25.50	15.24	15.24	20.19	20.19
68	31.00	31.00	20.32	20.32	25.27	25.27
84	36.10	36.10	25.40	25.40	30.35	30.35

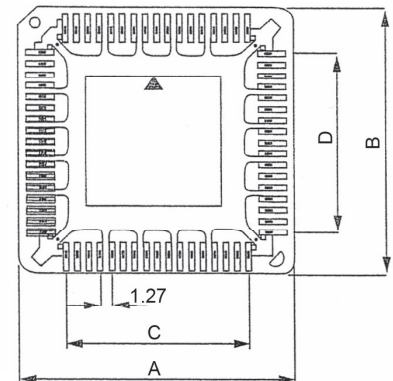
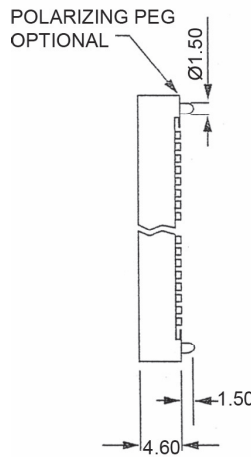
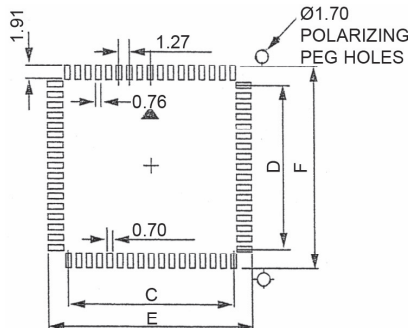

Ordercode

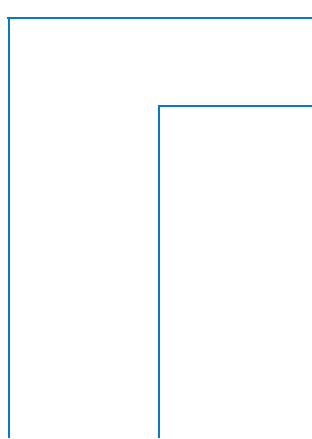

**No. of contacts**

20 / 28 / 32 / 44 / 52 / 68 / 84

**Version**

SM - without polarizing peg  
SM/P - with polarizing peg

**A** **CCS** **0** **xx** **Z** **x**

Please replace „x“ appropriate option

**Insulator material**  
PBT, UL94V-0

**Contact material**  
Sleeve - Brass  
Clip - Phosphor bronze

**Plating**  
Ni, Au / Sn

**Contact resistance**  
4mΩ max

**Insulation resistance**  
10000MΩ min

**Current rating**  
3A

**Operating temperature**  
-40°C - +105°C

**Operating voltage**  
100V AC

**Test voltage**  
500V AC

**Packing**  
Polybag packing

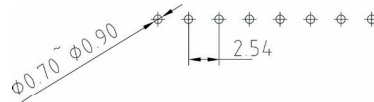
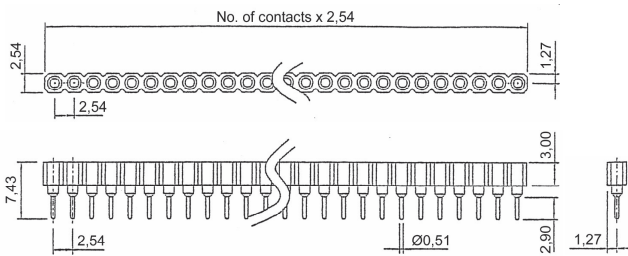
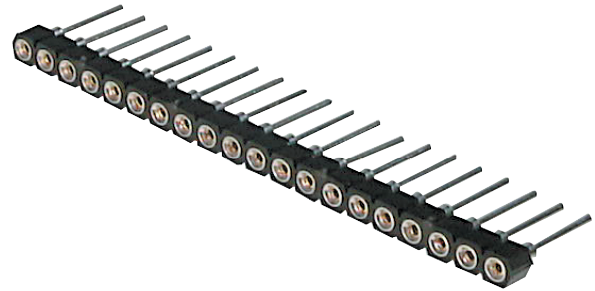

Ordercode

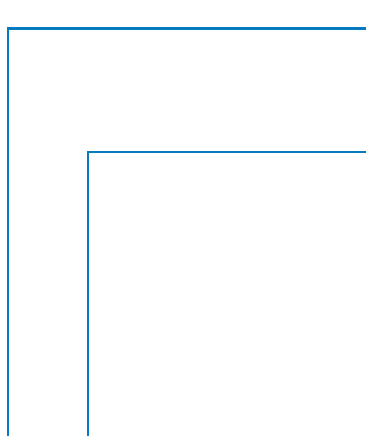

**No. of contacts**  
01 - 64  
(Standard = 20 , 32))

**Plating sleeve**  
G - Flash Gold  
Z - Tin

**AW** **127** **xx** **x** **T**

Please replace „x“ appropriate option

**Insulator material**  
PBT, UL94V-0

**Contact material**  
Brass

**Plating**  
Ni, Sn

**Contact resistance**  
4mΩ max

**Insulation resistance**  
10000MΩ min

**Current rating**  
3A

**Operating temperature**  
-55°C - +125°C

**Operating voltage**  
100V AC

**Test voltage**  
500V AC

**Packing**  
Polybag packing

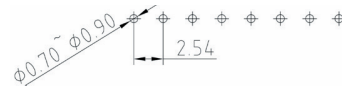
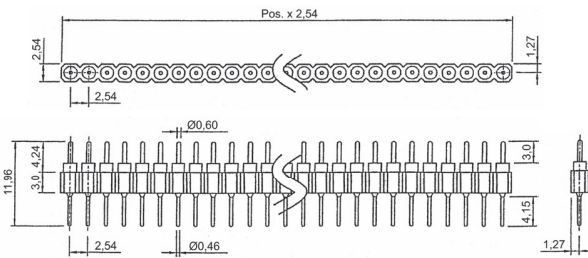
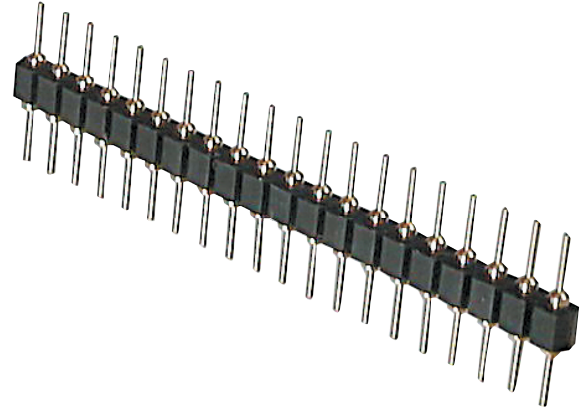

Ordercode

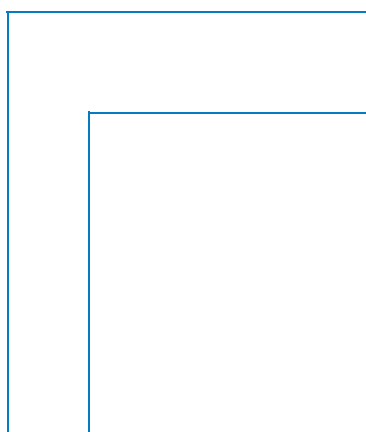

**No. of contacts**

01 - 64  
(Standard = 20 )

**Plating pin**

G - Flash gold

**AW 122 - xx / G - T**