



welcome



FG Workspace - a part of the Frem Group of companies.

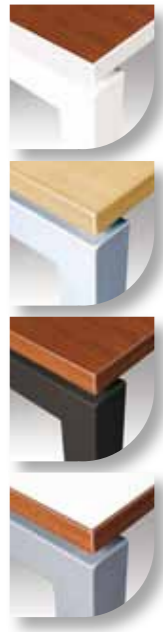
FG is a multi functional manufacturer with UK based production, specialising in wood, laminate and steel manufacture but with the capacity to handle specialist materials. Experienced craftsmen use traditional and contemporary methods to provide both standard and bespoke solutions.

Whatever the requirement, the FG support team can assist from concept to creation and will always deliver a quality service and product.

contents

bench systems	04
beam	10
cantilever	12
panel	14
contract	16
storage	18
meeting tables	20
technology	24
screens	26
cable management	28
seating	30
credentials	38
environment	39

Frame / Top Options



Bench Systems

The clean contemporary lines of the FG bench systems include recessed central legs to provide uninterrupted and flexible workspace.

This is complemented with the floating top design detail that brings a touch of style with functionality. All bench ranges are available with a wide variety of accessories including comprehensive wire management, system screens and storage.

A comprehensive selection of top and frame finishes allows FG bench to compliment any interior.



Bespoke Desking Service

If you cannot find what you require, or have awkward workspaces to accommodate, FG Workspace's bespoke desking service and **free six step design process** makes achieving your ideal bench system simple and hassle free. Contact your approved distributor for more details.

04

Frame Finishes

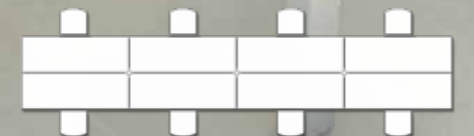


Top Finishes

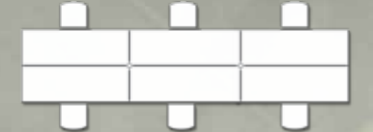


Table Configurations

Back to Back (8 person formation) ▶



Back to Back (6 person formation) ▶



Back to Back (4 person formation) ▶



Back to Back (2 person formation) ▶



All Bench systems are available in single and double sided configuration.



Cable Management
The demountable wire management system allows for easy cable access.

Design
Floating style top offers contemporary styling & clean lines.

Bench 50

Providing a perfect solution for today's workspace needs.

Cost effective benching that provides optimum use of space with ergonomic benefits. Ideal for highly populated office spaces where multiple work stations are required to suit collaborative working. Bench 50 ensures a pleasant working environment and clean minimalist styling.

shown:

Back to Back
(2 person pack)
1800x800x725
BN5/1808/B2

Double Sided
(8 person pack)
1800x800x725
BN5/1808/B8

3 Drawer Pedestal
430x600x610
SG/HDTMP3

2 Door Tambour
(side opening)
1020x522x725
SG/CDT07

2 Drawer Side Filer
1020x522x725
SG/SF2

Screens
1800
SC5/04185

Ibuki Operator Chair
4 options available

▶
**Sliding desk tops
(Standard)**
Enables top access to
cables. Lock in lock
out mechanism to
ensure user safety.

**Height adjust
(Optional)**
The robust
height adjustable
mechanism allows
for simple operation.
This unique feature
gives the option to
retro-fit individual
stations. This is a true
sit stand table that
can be elevated to
any point between
725mm & 1100mm.

08



Bench 80

Combining design excellence with ultimate functionality. Bench 80 sets the standard for others to follow with quality finishes and unique product features.

Bench 80 is a premium range offering a specification that is not normally expected as standard. An integrated package that excels with flexibility and performance. Bench 80 is a culmination of extensive market research and engineering development which surpasses all expectations.

shown:

Back to Back
(2 person pack)
1600x800x725
BN8/1608/B2

Back to Back add-on
(2 person pack)
1600x800x725
BN8/1608/B2A

3 Drawer Pedestal
430x600x610
SG/HDTMP3

Screens
1600
SC50416H

**Ibuki Operator
Chair**
4 options available

Storage Wall
standard or bespoke
solutions available



◀ **Metal work**
Metal to metal fixings ensure a rigid construction.

◀ **Formations**
The extensive range of top shapes allow for a variety of configurations.

Beam

A contemporary twist to a traditional desking solution. FG Beam offers true value for money without compromising on style and quality.

Dynamic work spaces can be achieved by combining a variety of desk configurations to gain a flexible and versatile workspace. FG Beam is a perfect solution where space is at a premium, cable management is a pre-requisite and budgets are low.

shown:

Double Desk Wave
1600x800x700x800
BM/DW16

120° Desk
1200x1200x725
BM/120

Screens
1200
SC50416H

Ibuki Operator Chair
4 options available

Slimline Pedestal
320x600x610
SHDTMP3SL

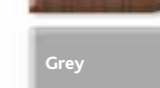
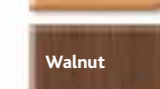
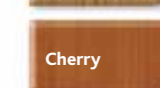
Storage Wall
standard or bespoke
solutions available



Frame Finishes



Top Finishes



► **Features**

High grade tooling enhances the look of legs.

System or contract screens can be specified for this versatile range.

Integral modesty panel to conceal cables and maximise stability.



12

Frame Finishes

Silver

Top Finishes

Maple

Oak

Cherry

Beech

Walnut

Grey

White

Cantilever

FG Cantilever is a traditional workstation with simple design lines.

Highly engineered to allow the regular 'churn' that is essential to a changing environment. An integral modesty panel allows for maximum rigidity whilst offering a concealed area for cable management.

shown:

Rectangular Desk
1600x800x725
CL/D1608

D Shaped Half Extension
1600x800x725
EXT1608

3 Drawer Pedestal
430x600x670
SG/HDTMP3

Ibuki Operator Chair
4 options available

Side Opening Tambour Cupboard
1020x522x725
SG/CDT07

Screens
1600
SC5/0316H

►
Features
Inherent strength
and solid appearance.



14

Finishes

Maple

Oak

Cherry

Beech

Walnut

Grey

White

Panel

FG panel has the aesthetics and symmetry to meet the demands of today's evolving working environment.

It provides a flexible solution when configured in clusters and a bold statement as an executive suite. Elegance and practicality at its best.

shown:

Bowfront Crescent
Desk
1800x1300x800x600
(right hand desk shown)
PA/BC18R

Executive Return
Unit
800x650x725
(right hand option shown)
SG/ERUR

3 Drawer Pedestal
430x600x610
SG/HDTMP3

Ibuki Operator Chair
4 options available

What we do

The complete work space solution

As part of the Frem Group, one of the UK's leading office furniture manufacturers, FG Workspace are able to offer the complete solution to all of your office furniture requirements.

Frem Group gives you the reassurance of:

- A proven track record of over 20 years successful trading worldwide
- A proven track record of working with major blue chip clients
- A proven track record of working on major publicly funded projects (schools, hospitals, local authorities)

quality

We pride ourselves in the quality of our workmanship, service and total commitment to the complete satisfaction of our customers. ISO 9001 accredited.

service

Service with attention to detail is at the forefront of every project we undertake. No matter how large or small the project, we approach it with the same level of dedication and professionalism, working with you and understanding your needs to ensure that our products exceed your expectations in every way.

sustainability

Wherever possible, Frem Group manufactures products using recyclable materials and takes its responsibility for the environment and sustainability seriously. This is reflected in the practices and processes that are consistent both internally and throughout our supply chain.

innovation

The Frem Group are continually seeking ways to innovate and develop our product offering to better suit the requirements of our customers. Ask us about how we can reduce carbon footprint, save energy costs and integrate technology into our entire product range.

design

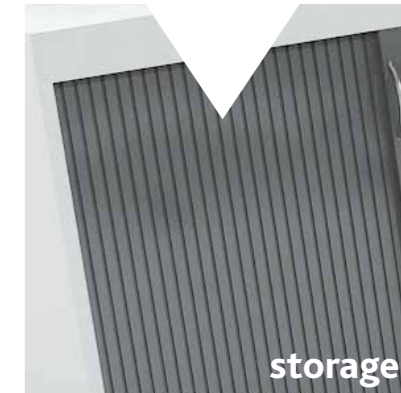
The entire workforce share a passion for design which is at the heart of every project we undertake. We consider our highly skilled design team, who are used to working with specifiers, architects and dealers alike, the backbone of the company.



workspace



seating



storage



technology



www.fgworkspace.co.uk

Feature
Simple leg design provides a cost effective solution.

A range of matching storage complements this range allowing for both individual and team based working solutions.

16

Frame Finishes

Silver

Top Finishes

Maple

Oak

Cherry

Beech

Walnut

Grey

White



Contract Desking

The FG contract range provides an excellent value cantilever desking solution that is both sturdy and durable, yet stylish and functional.

Manufactured to your specification, various top shapes allow for a cost effective use of space.

Products shown:

Crescent Desk
1600x1200x800x650
CT/C16R (right)
CT/C16L (left)

3 Drawer Pedestal
430x650x725
SG/6CTDHP3

2 Drawer Side Filer
1020x522x725
SG/SF2

Desk Height Pedestal
430x800x725
SG/8CTDHP3

Corner Unit
800x800x725
SG/CU90

Side Tambour Unit
1020x522x1600
SG/CDT16

Ibuki Operator Chair
Four options available



Features
 Ranges include stand alone items, although integrated and bespoke storage are our speciality.

If you cannot see what you are looking for or want to maximise your storage in any given area, our bespoke storage service will ensure that you gain optimum use of space.



Slimline Mobile Pedestal
 315x565x600
 (3 drawer)
 SG/STMP3SL

Heavy Duty Mobile Pedestal
 3 drawer with top
 390x565x618
 SG/STMP3TOP

Tall Slimline Under Desk Pedestal
 320x600x610
 SG/CTTMP3SL

Desk High Pedestal
 430x650x725
 (3 drawer)
 SG/6CTDHP3

Desk High Pedestal
 430x650x725
 (2 drawer)
 SG/6CTDHP2

Storage

Efficient storage solutions to suit your every need.

Combining stylish looks and a solid durable construction, FG Workspace can offer one of the widest ranges of storage giving you the flexibility to choose a suite of storage products to suit any office. So whatever your requirement FG Workspace will have the perfect storage solution for you.

Mobile shelving systems allow you to either halve the space required for your storage or double the storage capacity within the same footprint of traditional racking.



Side Opening Tambour Cupboard
 1020x522x1600
 SG/CDT16

2 Door Cupboard
 1020x522x1600
 SG/CDD16

Bookcase Open Front
 1020x380x1600
 (3 adjustable shelves)
 SG/CTTMP3SL

Side Filer Drawer
 1020x522x725
 (2 drawer)
 SG/SF2

Desk End Storage
 800x522x725
 SG/8DESO07

Side Opening Tambour Cupboard
 1020x522x2000
 SG/CDT20

2 Door Cupboard
 1020x522x2000
 SG/CDD20

18

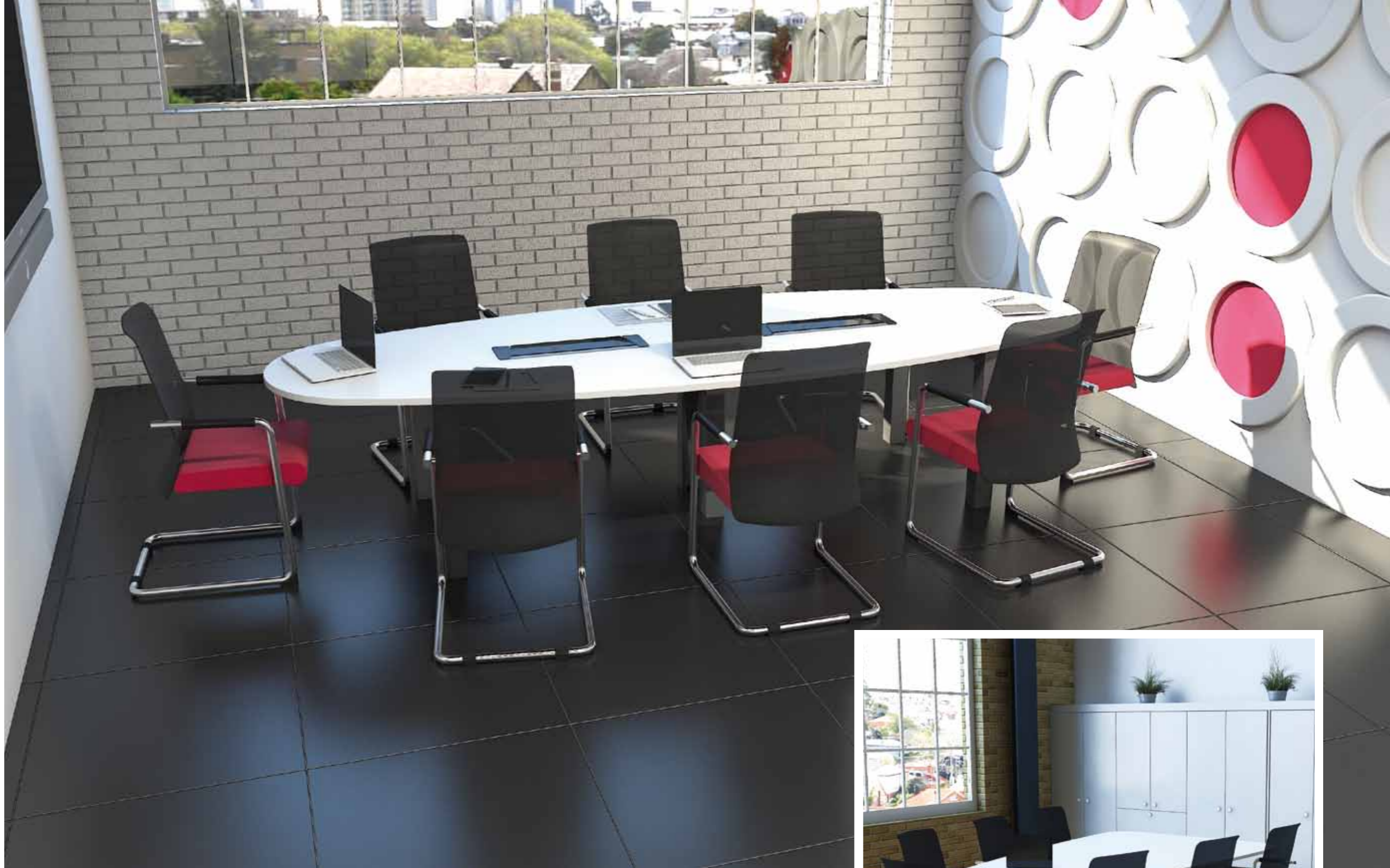
Finishes

- White
- Maple
- Oak
- Cherry
- Beech
- Walnut
- Grey
- Silver

► Features

Meeting Room tables are available with a wide range of top finishes including real wood veneer, laminate, mfc, solid surface and glass. These are complemented with either wooden or metal bases.

All FG tables can be supplied with power modules and full AV integration.



20

Frame Finishes

Silver

White

Graphite

Top Finishes

Maple

Oak

Cherry

Beech

Walnut

Grey

White

Meeting tables

FG workspace are able to offer complete meeting room solutions to include all of the elements that you may require, from meeting room tables, seating, audio visual walls, credenzas and lecterns.

With a huge range of standard shapes and sizes, available in your choice of finishes, we provide either contemporary or traditional options.

Products shown:

Conference Table (elipse)
3200x1200x725
BMT80

Conference Table (pear)
3000x1800x725
TB/PEARA3018

Rotating Power Module
CM/ROTATE

Storage Wall
Standard or bespoke solutions available



Features
 Circular, square
 and rectangular
 tops available as
 standard.

Wooden and
 metal bases in
 various styles.



Circular Table
 800 Diameter
 400 Height
 TB/CFTC1RD08



Coffee table
 Triangle with leaf
 FGL10667



Coffee table
 Two tier triangle
 FGL10196

Informal tables

FG workspace offer an unrivalled selection of informal tables that can be used in reception, break out and informal meeting areas.

The variety of tops, finishes and shapes make them an important accessory to complete any environment.



Coffee table
 Triangle with
 drop shelf
 FGL10197



Coffee table
 Circular with leaf
 FGL10666



Coffee table
 600x600x400
 TB/CFTSQ06



Coffee table
 Two tier rectangle
 FGL11101

Base Finishes

Silver

Top Finishes

Maple

Oak

Cherry

Beech

Walnut

Grey

White

► Features

Clean, aesthetic lines with no clutter or visible cables. Space-saving and difficult to damage or steal.

Fully and easily upgradeable, safe and ergonomic. Versatile and totally silent I.T.

Green – save up to 1 ton of carbon per PC per year.



24



Technology

The FG workspace offering is further enhanced by our ability to integrate technology into all of our furniture ranges in a contemporary and stylish way.

FG technology, specialises in integrating desktop technology into furniture using a patented remote controlled system. This solution is versatile and can be installed into desking, pedestals and bespoke furniture items. The CPU is stored up to 20 metres away and controlled remotely to ensure maximum security and minimum power wastage.



Acrylic Options
Broad range of
acrylic colours
available.



Screens

The extensive range of screens available will suit any office workspace situation. All standard desk size screens can be provided in any configuration, with a bespoke element being possible for non standard spaces.

Maximise productivity, reduce sound levels and create a relaxing and visually interesting work space. Screens can be floor mounted, desk mounted or free standing and used to create dynamic work spaces.

Bench mounted screen
with fabric infill panel
(top)
SC50616
(right)
SC1/3216

Desk mounted screen with
acrylic infill panel and
rail slatwall
(page 27)
SC5/0516H



26

Sample of Fabric
Options Available



Broad range of
screen fabric
colours, including
Camira & Kvadrat
are available.



Features

Possible cable routes highlighted with on desk power modules, screen and monitor options shown.



28

Cable management

Cable management is a major focus when considering desking solutions. FG workspace offers a complete range of products and accessories to solve your cable management problems.

FG workspace has considered cable management in the design of all of its products. Using modern engineering FG workspace can offer intuitive user friendly solutions.

Teemex power rail
UKA0403

Index power rail
UKEC0403

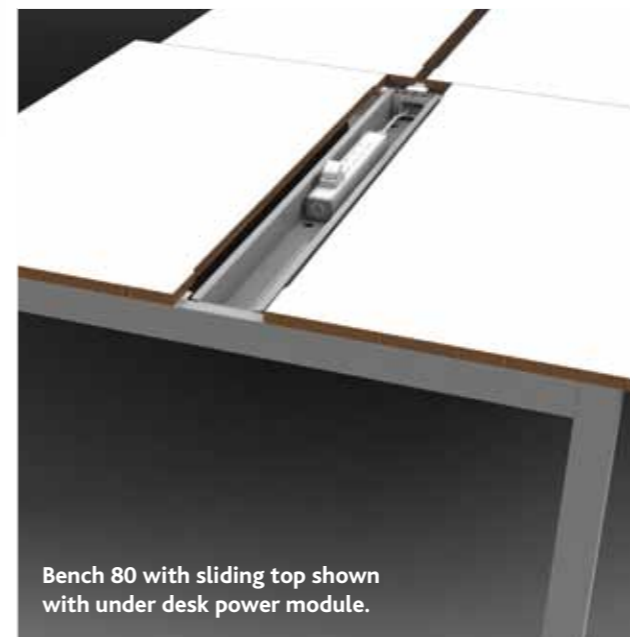
Vertra Xtra
AXX50WT

Meetex
EX10203SL

Vertra Xtra base
AXXB

Monitor Arm (left)
ELG3-202

Monitor Arm (right)
ELG-401



Bench 80 with sliding top shown with under desk power module.



Meeting table with integrated power and data module concealed beneath flap.

► **Features**

Height and twist
adjust arm rests,
lumbar support and
base options
available.

Memory foam for
comfort and support.

Executive Seating

With a number of carefully selected, high performance seating ranges, FG workspace offers solutions to any executive seating requirements.

These key products will compliment any executive office suite whilst offering comfort and ergonomic benefits.

Zircon – multiple
options available
Can be supplied in a
vast range of fabrics.



Ibuki – multiple
options available



30

**Ibuki Seating
Fabric Options**

R5

T5

Q5

M1

E6

**Ibuki Backrest
Mesh**

Black



Features
 Height and twist
 adjust arm rests,
 lumbar support
 and base options
 available.



Task seating

Designed for comfort and durability, the task seating range is affordable, practical and colourful.

Attention to detail and ergonomic consideration gives the task seating range broad appeal at every price point. Available with a full range of arm, base and control options, the range offers everything that is required from a task chair.

shown:

lolite

Lapis



Features
 Meeting chair
 options for these
 ranges shown.



lolite

A stylish range of Operator Chairs offering an extensive choice of options.

Features

- Choice of medium or high back.
- Choice of seat widths (standard or task).
- 2 lever back rake adjustment.
- Seat height adjustment.
- Wheel operated back height adjustment.
- Black 5 star base.

Lapis

Features

- 3-lever heavy duty asynchronous mechanism.
- Bodyweight tension control.
- Seat height adjustment.
- Ratchet back height adjustment.
- Suitable for users up to 150kg.
- Fold-down height adjustable arms.
- Seat slide.
- Inflatable lumbar support.
- Generous seat and back.





Soft Seating

FG Workspace blends great design with the best of British craftsmanship in delivering contemporary soft seating.

Producing quality products that meet the needs of modern commercial interiors, our philosophy and objectives are built upon four simple yet effective principles. Belief and dedication in the strength of British manufacturing, passion for design, belief in quality and a commitment to sustainability.

We also offer bespoke services.

Glacier Single Seater Base Unit
(angle arm)
o/a height: 430 o/a width: 670 o/a depth: 670
ICE001

Glacier Double Seater Base Unit
(single inset back)
o/a height: 430 o/a width: 1340 o/a depth: 670
ICE002

Glacier 4 Seater Base Unit
(double inset back)
o/a height: 430 o/a width: 1340 o/a depth: 1340
ICE004

Glacier
Glacier is a contemporary modular seating system - so flexible it can be configured from single units to complex arrangements. Designed to enhance any breakout or public environment, the units can be used individually or linked, depending on the space available.

Just order like building blocks! - pick your seat choice first, then add any back code/s and if arms are required add them at the end.

34

Fabric Options
Comes with a comprehensive range of fabric options and wooden or polished legs.



◀ **Agate**
 Agate is a versatile range of square modular reception/break-out seating. Available as a seat or pouffe. Each unit can be used individually or as part of a group dependant upon your requirements. Choose from a wide range of fabrics, with an option of contrasting seat and backs for a fun contemporary look.

Agate Chair
 o/a height: 820
 o/a width: 700
 o/a depth: 700
 GRA001

Agate Pouffe
 o/a height: 475
 o/a width: 700
 o/a depth: 700
 GRA002



▲ **Cornelian**
 A contemporary range of upholstered stools. Available as round and square shapes, with polished feet. Both have detailed stitching and the lower half of the square stool has concave detailing, ideal for any environment. The most modern fabrics and leathers complete the look for a fun contemporary feel.

Cornelian Square Stool
 o/a height: 455
 o/a width: 420
 FLA001

Cornelian Round Stool
 o/a height: 455
 o/a width: 410
 FLA002



▲ **Geo**
 Functional pebble shaped stools bring a new and modern seat for informal meeting spaces and breakout areas. Shown in a pebble effect fabric, they could be covered in vibrant fabrics and leathers to stimulate or pastel shades to calm the working environment.

Twist
 o/a height: 440 o/a width: 110 o/a depth: 900
 SUN001

Spark
 o/a height: 440 o/a width: 112 o/a depth: 760
 SUN002

▶ **Sphene**
 Contemporary design with stylish detailing, fully upholstered contemporary furniture with smooth lines and simplicity in mind. Single or twin available with either chrome or wooden feet or a polished skid frame.

Sphene Single
 o/a height: 700
 o/a width: 870
 o/a depth: 760
 MOR001

Sphene Twin
 o/a height: 700
 o/a width: 1425
 o/a depth: 760
 MOR002



◀ **Pearl**
 Pearl is a contemporary range ideal for open space environments. The simplistic design with straight lines enhance the overall appearance of this range.

Pearl Single
 o/a height: 740 o/a width: 970 o/a depth: 760
 MOO001

Pearl Twin
 o/a height: 740 o/a width: 1600 o/a depth: 760
 MOO002

Pearl Three Seater
 o/a height: 740 o/a width: 2210 o/a depth: 760
 MOO003

Pearl Pouffe
 o/a height: 460 o/a width: 760 o/a depth: 760
 MOO004

Pearl Table
 o/a height: 460 o/a width: 760 o/a depth: 760
 MOO005

Credentials

FG workspace is an innovative organisation with a clear policy of continual improvement in product and service. Constantly pushing the boundaries of design, FG workspace help to create unique solutions that are both stylish and functional.

In an ever changing world it is essential that the workplace adapts to new challenges and trends. FG Workspace are always at the forefront pioneering new concepts.

Environment

Wherever possible FG workspace manufactures products using recyclable materials and takes its responsibility for the environment and sustainability seriously. This is reflected in the practices and processes that are consistent both internally and throughout our supply chain. We only source wood from sustainable well managed forests and always obtain full chain of custody certification.

We have an established environmental policy which is regularly updated to incorporate our commitment to reducing our impact on the environment by managing waste effectively, reducing carbon footprint and pollution.

Wherever possible FG workspace will offer an alternative to new furniture, taking opportunities to reuse and recycle.

FG workspace seeks to align itself with partners whose environmental credentials and ethos are in line with our own.

storwell

■ ■ ■ S Y S T E M S



More storage in less space

Working with a specialist partner with over 28 years experience in the storage sector is just one reason why you can trust Storwell Systems with your enquiries.

We are **objective, non-tied, independent, and impartial** and continually researching all the leading UK manufacturers for product quality and innovation; only selecting those companies whose **integrity, design** and **product range** are the best in the industry so... you don't need to.

You can be sure you will get impartial advice, the best prices and delivery times and a dedicated project manager giving you all the technical support you need for complete peace of mind.



T: 01527 592444 F: 01527 592727

E: sales@storwellsystems.co.uk

W: www.storwellsystems.co.uk