



# COLOUR PORT

**DIRECT WATER LEVEL GAUGE**



**Levelstate**

***Solution at all levels***



## Levelstate

---

Levelstate provides SOLUTION AT ALL LEVELS for steam generating plants. Products manufactured are Colour Port Type Direct Water Level Gauges (DWLG), Electronic Drum Level Indicators (EDLI) and Electronic Level Switches (ELS).

The guiding philosophy of reliability and user friendly design has made Levelstate a successful business entity. The user base includes Power, Petrochemicals, Refinery, Fertiliser, Sugar, Paper, Cement, Metallurgical and Chemical industries in various countries across the globe.

Various international agencies have approved Levelstate products. The quality system has been accredited ISO 9001. All Levelstate products are also available with CE mark.

With professional marketing efficiency and on-time service delivery, Levelstate assures its customers “value for money”. Factory trained engineers are available on call to provide diagnostic assistance, pre-engineering support, installation and commissioning services.

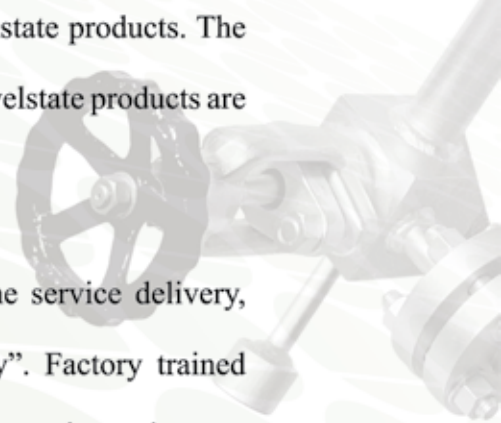

# COLOUR PORT TYPE LEVEL GAUGE

Levelstate Colour Port Type Direct Water Level Gauges (DWLG) provide a direct reading of the water level and are suitable for medium & high pressure steam/water applications. Levelstate gauges are reliable and maintenance free thereby minimising operating costs for the user.

## Operating Principle

Colour port type direct water level gauges operate on the principle of the differences in refractive index of different mediums (steam and water) for indication of the water level. The gauge consists of a vertically oriented metal body with a frosted glass to the front and the rear. The front and rear body surfaces are in non-parallel vertical planes. Behind the gauge body are light sources - red and green.

When light passes through the port (submerged in water), it gets refracted at an angle of approximately 10 deg. A Green indication is observed in the illuminator viewing panel. A Red indication is observed when there is no water in the port.

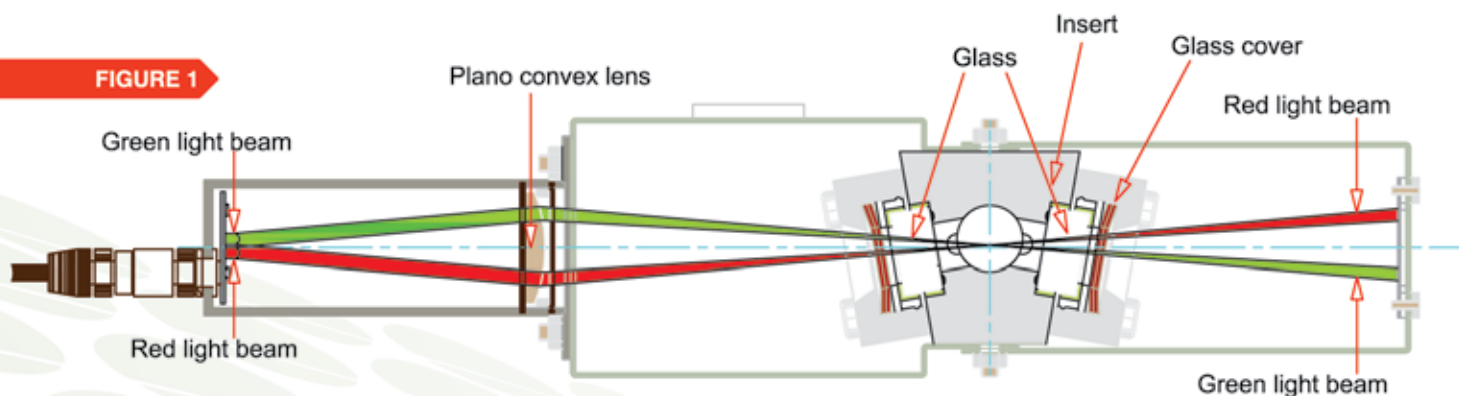

## Features

- Various levels of visibility and centre to centre distance depending on site requirement
- Stainless steel gauge body to prevent welding failure due to carbide precipitation thus ensuring long life
- High pressure block valves and medium pressure stuffing box valves
- Enhanced safety through orifice spacer in the steam side and ball check valve in the water side
- Internal components specially coated for corrosion protection
- Glass protected by high quality mica
- LED illuminator ensuring low power consumption and long life
- Suitable for harsh outdoor weather conditions
- Halogen illuminator (optional)
- Explosion proof (optional)

## Applications

- Boiler drum
- Feedwater heater
- Deaerated feedwater storage tank
- Condenser hotwell
- HP turbine bypass drain sump
- Cold reheat drain sump

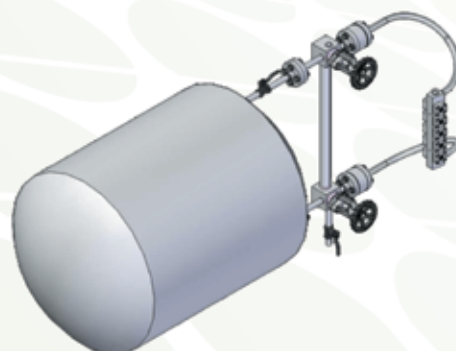



## Product Line

Levelstate DWLGs are available in various pressure ratings which used along with the high intensity illuminating device and accessories makes it one of the most reliable and user friendly systems available. Various configurations and options are available which are given below:



### High Pressure Gauge Type 300

The High Pressure Gauge Type 300 is suited upto 3000 psi and is available in various levels of visibilities to suit site requirement. The gauge is equipped with tie bar assembly fitted with high pressure block valves for compact installation and gauge isolation. Facility is available for installation of safety devices like orifice spacer and ball check valve.

### Medium Pressure Gauge Type 150

Levelstate Medium Pressure Gauges Type 150 is rated to 1500 psi and contains stuffing box valves allowing easy installation and maintenance at site. MP gauge is available in various visibilities and accessories can be supplied as per requirement.

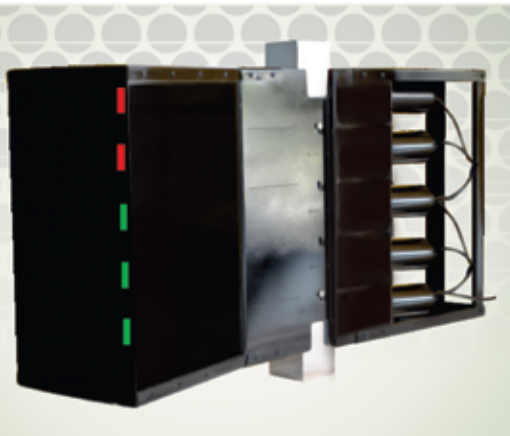

### Illuminator Type LED

The illuminator consists of high intensity LEDs providing Red/Green lighting indicating Steam/Water respectively. Usage of LED ensures low power consumption and long life thus reducing maintenance work. The illuminator is equipped with a viewing hood to provide correct reading during day time. Halogen illuminator and explosion proof options are available to suit requirement.

### Accessories

Various accessories are available to enhance system performance. Orifice spacer in the steam side and ball check valve in the water side can be installed to increase safety features of the system. Drain valve is also available for system blow down.

### Approvals

- Quality system accredited to ISO 9001
- Design approval of pressure parts, operational and field testing of the system
- Certification of explosion proof to international standard for use in hazardous area
- Third party inspection, testing and certification by approved international agencies

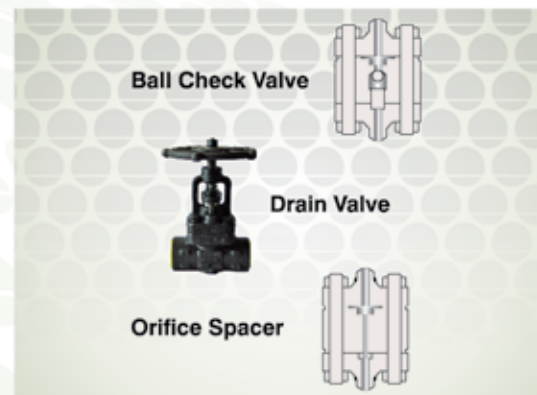

# HP GAUGE TYPE 300

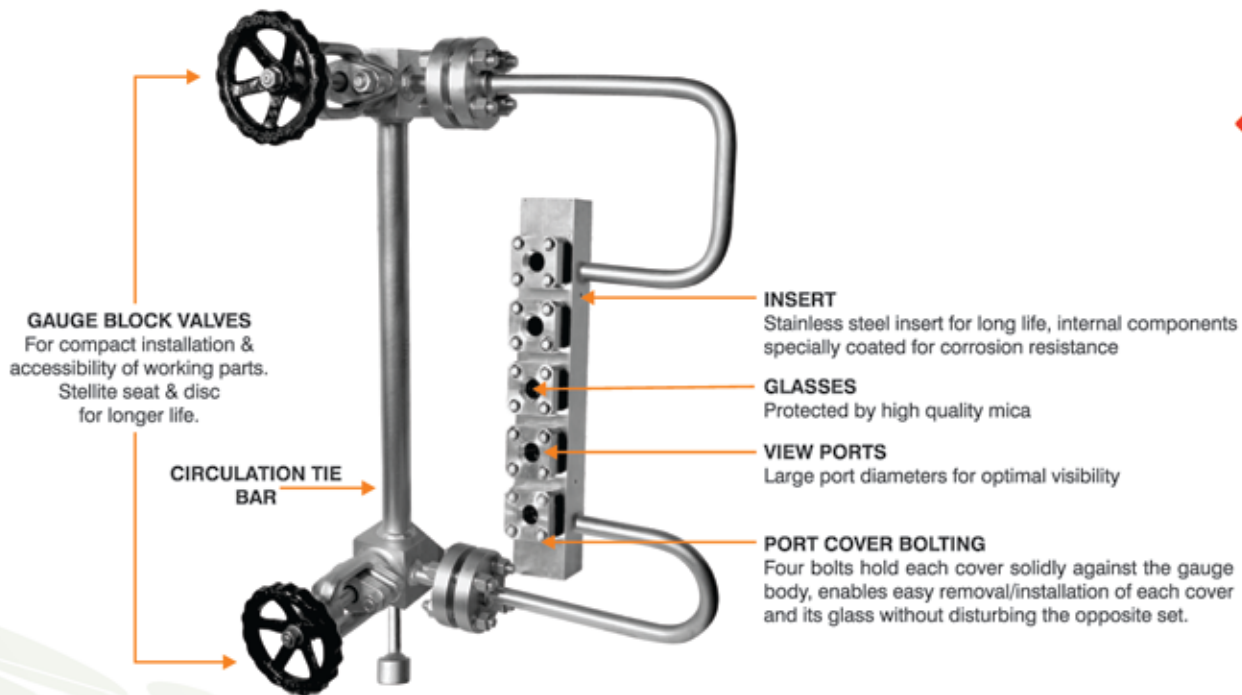
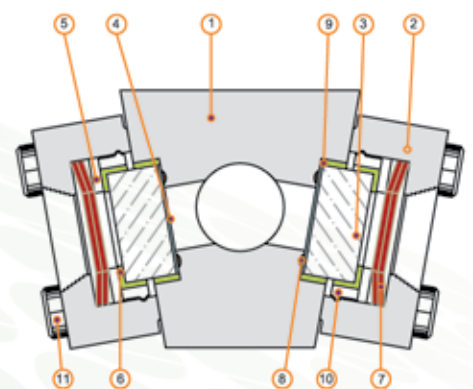

FIGURE 2

## HP Gauge Specifications

- Upto 3000 psi with service temperature upto 370°C
- Gauge block, piping, flanges manufactured from titanium stabilized SS321/SS316TT material to prevent weld failure due to carbide precipitation
- Visibility from 315mm to 1264mm
- No. of ports: 5 to 18
- Pitch options: 63.5mm or 73mm
- Single or double expansion loop to suit site requirement
- Process connections: BW/SW; options available to suit site requirement
- Drain connection: BW/SW; options available to suit site requirement
- Socket weld connections to ANSI B16.11
- Butt weld connections to B 16.25 or DIN 2559
- Flanged connections (optional)
- CE marking, if required
- HP block valve:
  - Body in forged A105 material
  - Solid stellite seat and disc
  - Naval brass yoke nuts to avoid ceasing at elevated temperature
  - Stems - grounds are nitrided to ensure long packing life
  - Available in universal configurations for fitment of gauge in any direction at site
- Accessories - ball check valve, orifice spacer, drain valve

## Port Assembly



ITEM	DESCRIPTION	MATERIAL
1	Gauge insert	SS-321/304
2	Cover	SS-304/A-105 (ENP)
3	Glass	Aluminium silicate
4	Mica	Indian ruby C & S.S.
5	Duco ring	AISI 420/1.4021
6	Cushioning ring	Asbestos free
7	Spring cones	X7Cr NiMoAl 15.7
8	Sealing gasket	Graphoil/Monel
9	Clip ring	AISI 302
10	Retaining ring	ARMCO 17.7
11	Bolts	A 193 Gr B7





## HP Gauge configuration options

(For ordering, please refer to the gauge codification sheet)



A

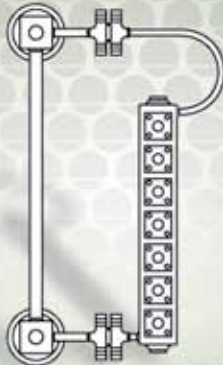

B

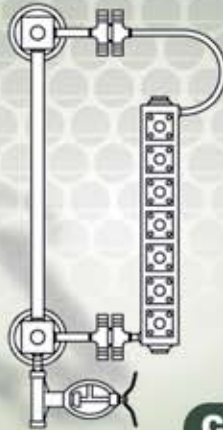

C

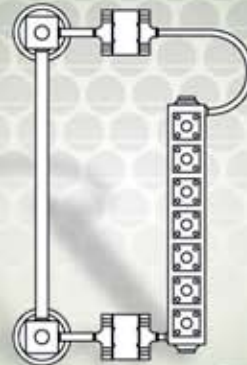

D

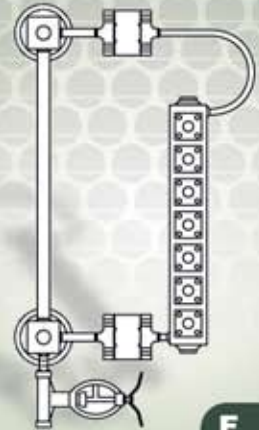

E



F

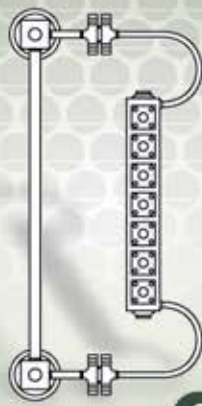

G

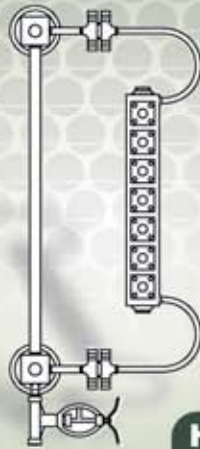

H

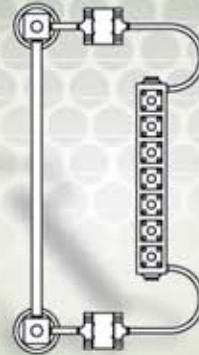

I

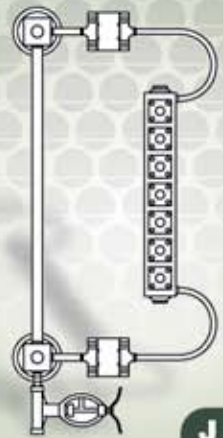

J

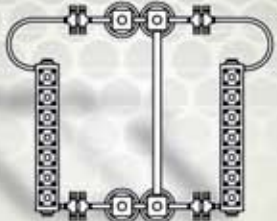

K



L

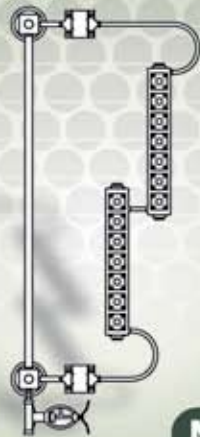

M

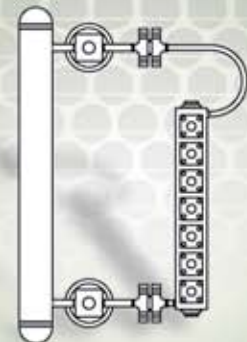

N

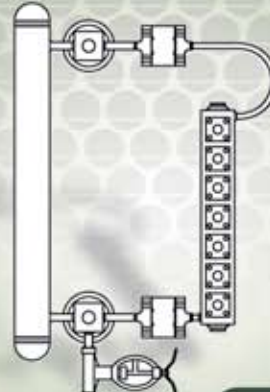

O

## Accessories



Ball Check Valve

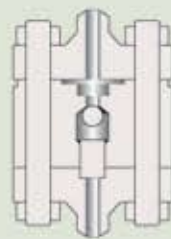

Orifice Spacer

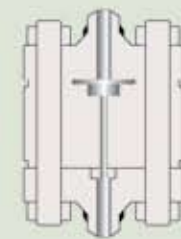

Drain Valve



Levelstate

[www.levelstate.com](http://www.levelstate.com)

*Solution at all levels*

# MP GAUGE TYPE 150

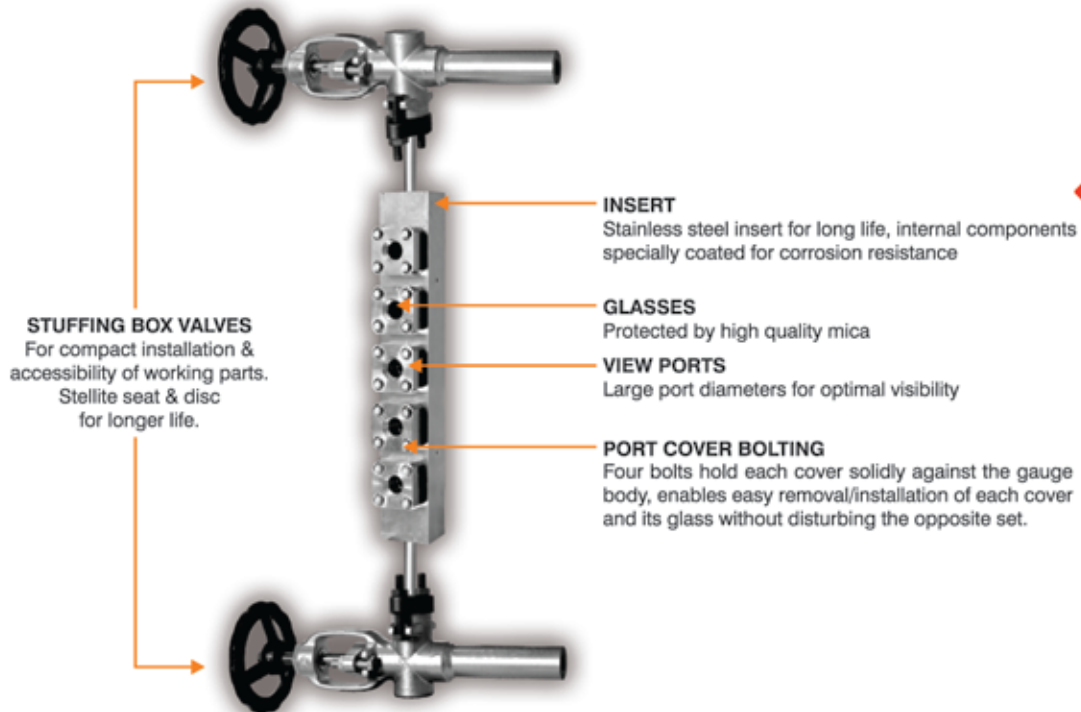

**FIGURE 3**

**STUFFING BOX VALVES**  
For compact installation & accessibility of working parts. Stellite seat & disc for longer life.

**INSERT**  
Stainless steel insert for long life, internal components specially coated for corrosion resistance

**GLASSES**  
Protected by high quality mica

**VIEW PORTS**  
Large port diameters for optimal visibility

**PORT COVER BOLTING**  
Four bolts hold each cover solidly against the gauge body, enables easy removal/installation of each cover and its glass without disturbing the opposite set.

## MP Gauge Specifications

- Upto 1500 psi with service temperature upto 313°C
- Visibility from 315 mm to 1264 mm
- No. of ports: 5 to 18
- Pitch options: 63.5mm or 73mm
- Process connections: BW/SW; options available to suit site requirement
- Drain connection: BW/SW; options available to suit site requirement
- Socket weld connections to ANSI B16.11
- Butt weld connections to B 16.25 or DIN 2559
- Flanged connections (optional)
- CE marking, if required
- Valve:
  - Body in ASTM A216WCB/A217WC6/WC9 high temperature investment casting
  - Solid stellite seat and disc
  - Naval brass yoke nuts to avoid ceasing at elevated temperature
  - Stems - grounds are nitrided to ensure long packing life
  - Available in universal configurations for fitment of gauge in any direction at site
- Accessories - ball check valve, orifice spacer, drain valve

## Port Assembly

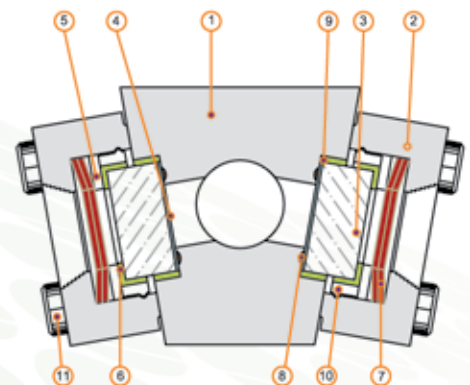

ITEM	DESCRIPTION	MATERIAL
1	Gauge insert	SS-321/304
2	Cover	SS-304/A-105 (ENP)
3	Glass	Aluminium silicate
4	Mica	Indian ruby C & S.S.
5	Duco ring	AISI 420/1.4021
6	Cushioning ring	Asbestos free
7	Spring cones	X7Cr NiMoAl 15.7
8	Sealing gasket	Graphoil/Monel
9	Clip ring	AISI 302
10	Retaining ring	ARMCO 17.7
11	Bolts	A 193 Gr B7





## MP Gauge configuration options

(For ordering, please refer to the gauge codification sheet)



A



B

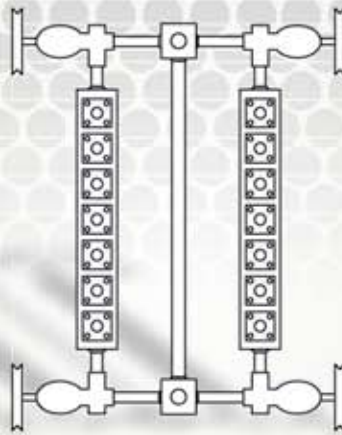

C



D

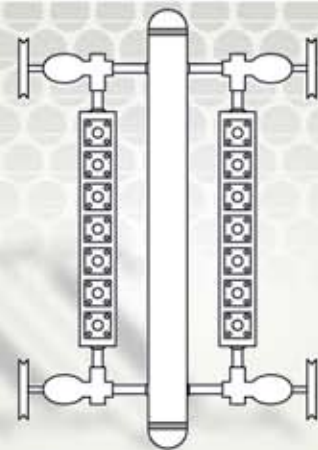

E

### Accessories



Ball Check Valve

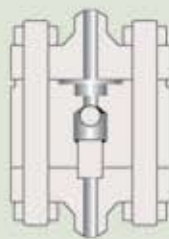

Orifice Spacer



Drain Valve



Levelstate

[www.levelstate.com](http://www.levelstate.com)

*Solution at all levels*



# ILLUMINATOR TYPE LED

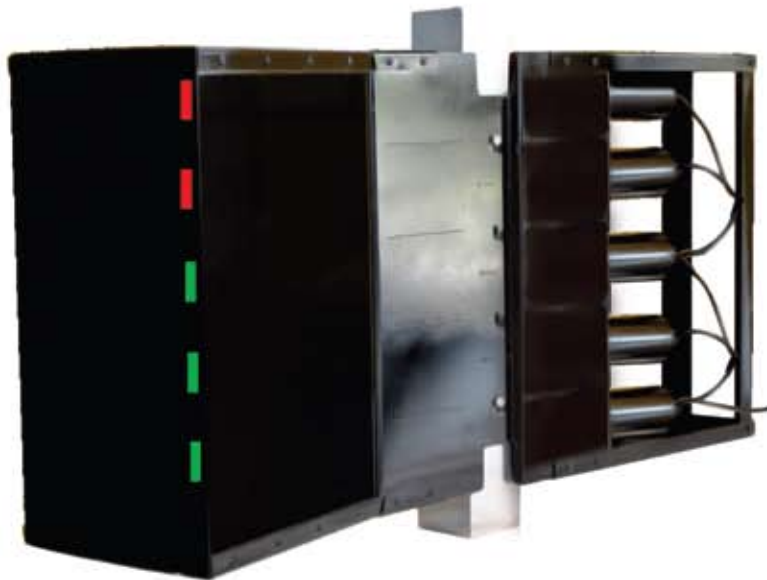

## Illuminator Specifications

- LED technology
- Modular version
- Indoor/outdoor application
- IP 65 protection
- No. of ports: 5 to 18
- High temperature powder coated MS body (Optional : Electro-polished SS body)
- Rating: 60mA per LED unit
- Power supply : 220V; optional - 110V
- Viewing hood available
- Earth connection available in standard configuration
- Explosion proof to suit site requirements (optional)
- Remote mounting of transformer/junction box (optional)

### Halogen illuminator (optional)

- Reflector type halogen spot lamp
- IP 44 protection
- High temperature powder coated MS body
- Rating: 20W/12V per lamp
- Power supply : 12V AC through 110V/230V AC to 12V AC step down transformer (200VA to 400VA, IP 65)

FIGURE 4

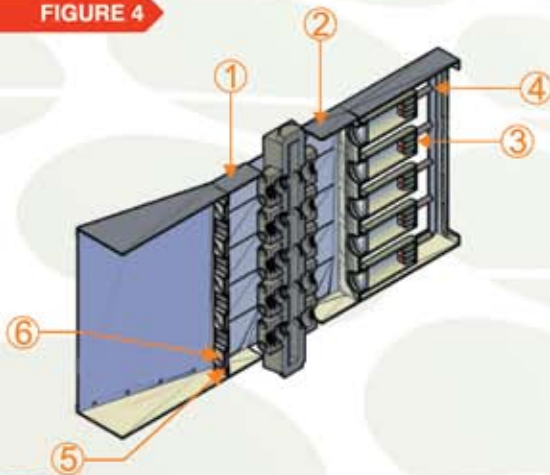

### Parts List

ITEM	DESCRIPTION	MATERIAL
1	Read - Out Housing	MS/SS
2	LED Unit Housing	MS/SS
3	LED Unit	MS/SS
4	T - connector and Cable	
5	Glass	Frosted Glass
6	Glass Holder	MS/SS

# Gauge Codification

1		Pressure Range
Options		
300	:	High Pressure - 3000 psi (Standard guage consists of body, circulation tie bar and block valves)
150	:	Medium Pressure - 1500 psi (Standard guage consists of body, tie bar and stuffing box valves)

2		Visibility
Options		
A0	:	5 Port - 315 mm
B0	:	7 Port - 404 mm
C0	:	7 Port - 461 mm
D0	:	9 Port - 531 mm
(Above 531mm visibility on request)		

3		Illuminator Type
Options		
LED	:	LED - IP 65
LEX	:	LED - Exed
(Illuminator consists of read-out housing, LED unit housing and transformer)		

4		Wing Type
Options		
SW	:	Single Wing
DW	:	Double Wing

5		Accessory
Options		
BOXX	:	Ball Check Valve & Orifice Spacer
XXDV	:	Drain Valve
BODV	:	Ball Check Valve, Orifice Spacer & Drain Valve

6		Special Option
Options		
SPL	:	Special Option - To be specified separately

Ordering Example						
Designator	1	2	3	4	5	6
Model No.*	300	- C0	- LED	- DW	- BOXX	- SPL

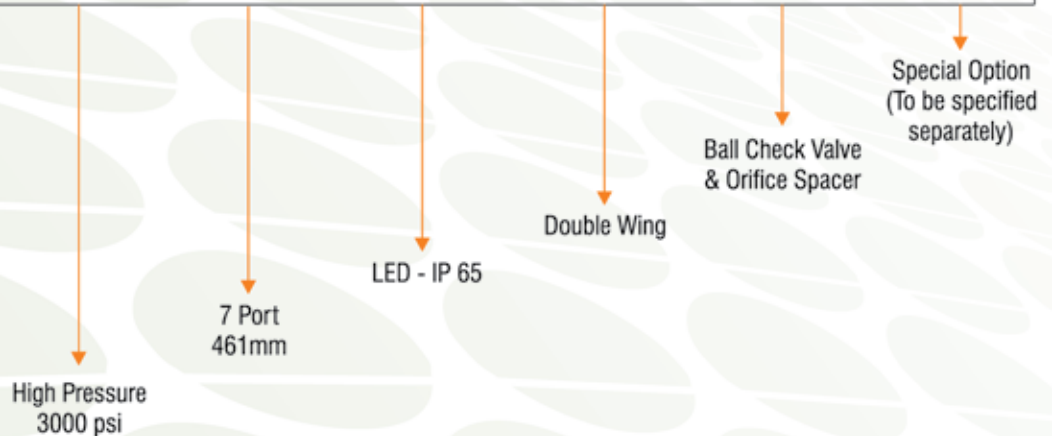

\*In case not applicable, please put XX





Levelstate pursues a policy of continuous technical innovation and product development. The information given in this document may change without notice. © 2012





# Levelstate

**Levelstate Systems Ltd.**

Little Kitfield, Gradwell Lane, Four Marks  
Hampshire GU34 5AS, England  
Tel : +44 (0) 1962 773829

Authorised Sales Partner

