



# UNIVERSAL

accessories

Simple and fast ventilation and dry fix solutions  
including NEW RidgeFast and HipFast

[www.marleyeternit.co.uk/universal](http://www.marleyeternit.co.uk/universal)

# The **UNIVERSAL** range – covering the whole roof

Marley Eternit Universal systems can be used across all key roof areas, from eaves to ridge. Not only are they completely dry fixed, but can provide ventilation solutions that help meet the Building Regs, British Standards and NHBC guidelines.

They're tough, durable, easy to fit and reduce maintenance expenses. And they're designed to fit seamlessly with roof coverings, giving performance alongside clean, uninterrupted lines wherever they're installed.

Visit our website to find out more [www.marleyeternit.co.uk/universal](http://www.marleyeternit.co.uk/universal)

All **UNIVERSAL** ranges offer:

- ✓ Simple, rapid installation
- ✓ Meets UK Building Regulations, British Standards and NHBC guidelines
- ✓ Strength, durability and trouble-free functionality
- ✓ Helps combat condensation in the roof space
- ✓ No wet trades
- ✓ No mortar failure
- ✓ Reduces on-going roof maintenance expense
- ✓ No health and safety risk from repeat work



\* Minimum and maximum pitches will vary from product to product

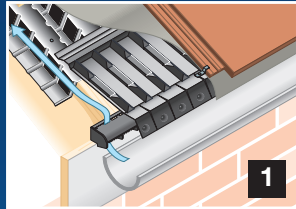

**UNIVERSAL 10mm and 25mm eaves vent systems**

- ✓ Simple and fast to install
- ✓ Eaves-to-ridge/ eaves-to-eaves ventilation
- ✓ Allows clip fixing of tiles at eaves
- ✓ Compresses insulation ensuring airflow
- ✓ Prevents ingress of birds, vermin and insects

Suitable for pitches\* from 12.5° - 55°

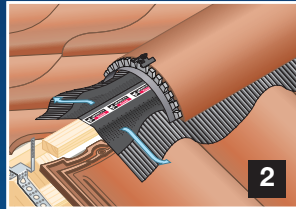

**UNIVERSAL RidgeFast**

- ✓ Strong and durable
- ✓ Unobtrusive appearance
- ✓ Completely dry fixed system
- ✓ Suitable with standard ridge tiles
- ✓ Provides 5mm continuous ventilation along the ridge
- ✓ Complements HipFast

Suitable for pitches\* from 12.5° - 60°

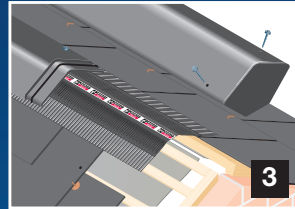

**UNIVERSAL Ridge Roll**

- ✓ For use with fibre cement slates
- ✓ Simple and fast to install
- ✓ Reduces on-going roof maintenance expense
- ✓ Unobtrusive appearance
- ✓ For ridges and hips
- ✓ Completely dry fixed system
- ✓ Provides 5mm continuous ventilation along the ridge

Suitable for pitches\* from 20° - 60°

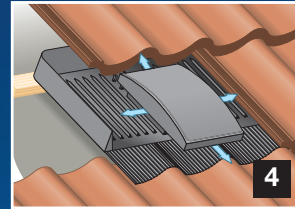

**UNIVERSAL tile vent terminal**

- ✓ Ideal for natural, mechanical or soil pipe ventilation
- ✓ Weatherproof, tough and durable
- ✓ Provides 15,000mm<sup>2</sup> free area of ventilation
- ✓ Choice of 3 colours available
- ✓ 20° minimum pitch

Suitable for pitches\* from 20° - 45°

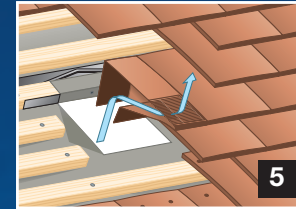

**UNIVERSAL plain tile vent**

- ✓ Ideal for natural, mechanical or soil pipe ventilation
- ✓ Weatherproof, tough and durable
- ✓ Provides 10,000mm<sup>2</sup> free area of ventilation
- ✓ 6 colours available
- ✓ 20° minimum pitch

Suitable for pitches\* from 22.5 - 60°



**UNIVERSAL dry valley**

- ✓ Dry fix, mortar-free system
- ✓ Latest tough, durable GRP technology
- ✓ Simple and rapid installation
- ✓ Can accommodate up to 20° pitch variance either side of valley
- ✓ Gives finished appearance of close cut roof

Suitable for pitches\* from 17.5° - 60°

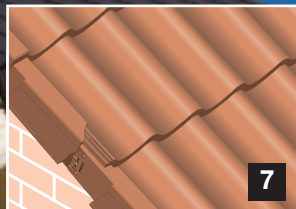

**UNIVERSAL dry verge**

- ✓ Strong and durable
- ✓ Weathertight and maintenance free
- ✓ Mechanically fixed
- ✓ Emulates appearance of traditional verge
- ✓ Easy and fast to install
- ✓ Suitable for verges with or without bargeboard
- ✓ Dry verge refurbishment kit allows retro-fit to existing verges

Suitable for pitches\* from 12.5° - 55°

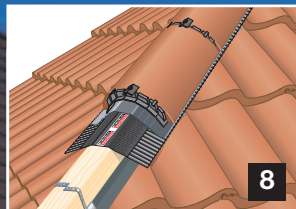

**UNIVERSAL HipFast**

- ✓ Simple and fast to install
- ✓ Unobtrusive appearance
- ✓ Completely dry fixed system
- ✓ Suitable for standard hip tiles
- ✓ Complements RidgeFast

Suitable for pitches\* from 12.5° - 60°



# The **UNIVERSAL** range – what comes in the box

Marley Eternit Universal ranges offer you simple, high performing solutions for all dry fix and ventilation applications.

These are out-of-the-box solutions which can be used with all Marley Eternit roofing products as well as those of other manufacturers.

Visit our website to find out more **[www.marleyeternit.co.uk/universal](http://www.marleyeternit.co.uk/universal)**



# The UNIVERSAL range – the detail

## Ridge solutions

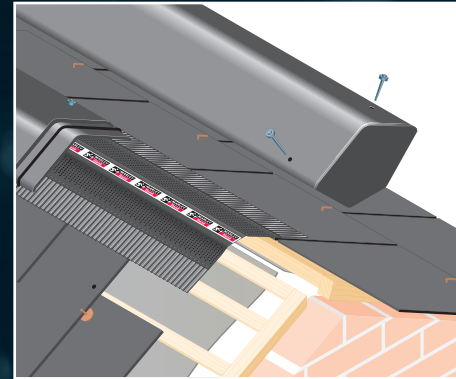
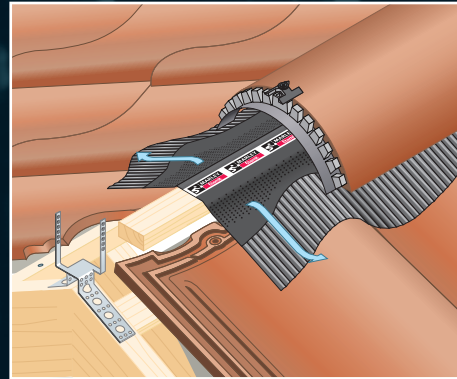
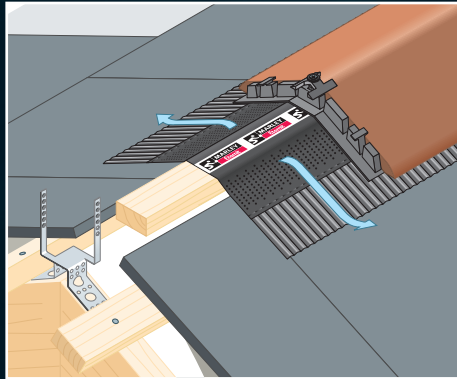

### UNIVERSAL RidgeFast

#### Key components

	Code
Universal RidgeFast system (6m pack) comprises of:	33000
Ridge roll (6m)	

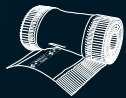

Ridge batten brackets (10 No.)	
--------------------------------	--



Ridge unions (13 No.)	
-----------------------	--



Tapered filler units (2 No.)	
------------------------------	--



#### Also available:

	Code
RidgeFast/HipFast Union Pack (6 no. unions)	33003
RidgeFast roll applicator	33002
RidgeFast blanking tape (2x 2m)	33001

### UNIVERSAL ridge roll

#### Key components

	Code
Universal ridge roll	33010

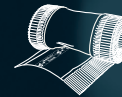

#### Fibre cement ventilated dry ridges

Duo pitch ridge	-
Stop end for duo pitch ridge	-
Roll top ridge	-
Stop end for roll top ridge	-



## Valley solutions

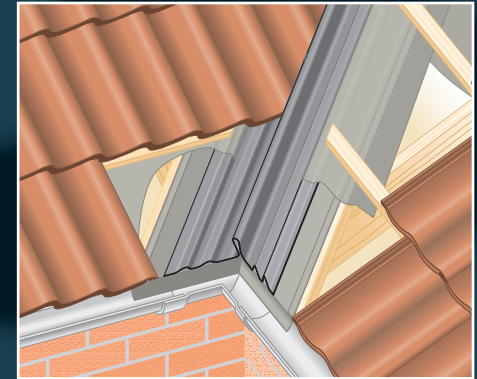

### UNIVERSAL dry valley

#### Key components

	Code
GRP valley (low profile)	30422

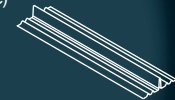

GRP valley (high profile)	30421
---------------------------	-------



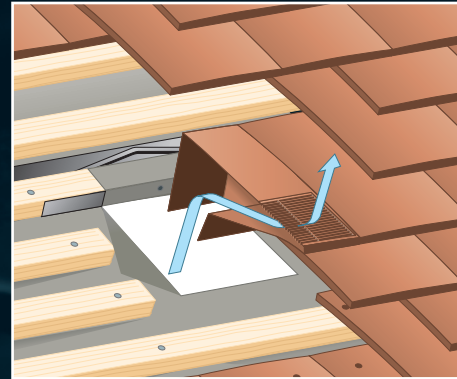
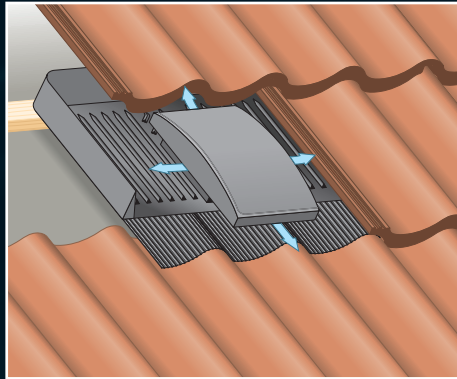

# The UNIVERSAL range – the detail

## Tile vent solutions

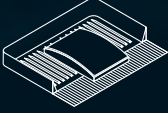

### UNIVERSAL tile vent terminal

#### Key components



	Code
Universal tile vent terminal	
Grey	36700
Brown	36703
Terracotta	36704
	
Flexible pipe	39091
ID 110mm (sold separately)	

#### Pressure resistance values

Pa (litres/sec airflow)	15	30	60
Free air area 15000m <sup>2</sup>	35	48	67

### UNIVERSAL plain tile vent terminal

#### Key components

	Code
Universal tile vent terminal	
Grey	45501
Brown	45502
Terracotta	45503
Red	45504
Clay Red	45505
Clay Brown	45506
	
Flexible pipe	39091
ID 110mm (sold separately)	

#### Pressure resistance values



Pa (litres/sec airflow)	15	30	60
Free air area 10000m <sup>2</sup>	13.6	53.7	211

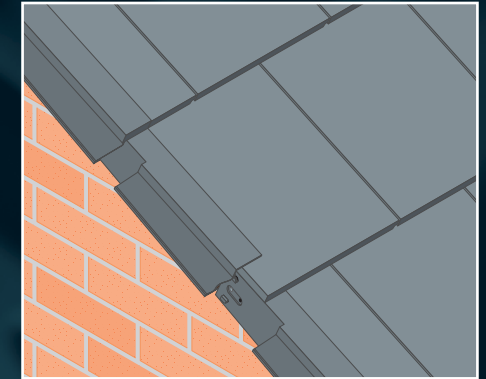
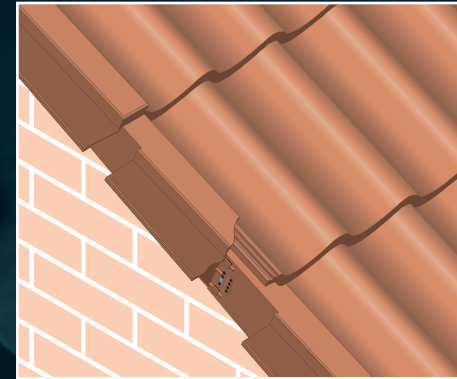

## Verge solutions



### UNIVERSAL dry verges

#### Key components

	Code
Verge unit	
left hand	391*
right hand	392*
	
Edgemere verge unit	
left hand	381†
right hand	382†
	
Modern ridge end cap	394*
	
Segmental ridge end cap	395*
	
Edgemere ridge end cap	384†
	

	Code
Modern mono-ridge end cap	
left hand	408*
right hand	409*
	
Segmental mono-ridge end cap	
left hand	427*
right hand	428*
	
Dry verge refurbishment kit (to fix 24 units)	MA35801
	
Dry verge fixing kit (to fix 28 units)	39300
Edgemere dry verge fixing kit (to fix 28 units)	38300

\* Suffix with colour code: 01 Grey, 03 Brown, 04 Terracotta  
 † Suffix with colour code: 01 Grey, 03 Brown

## Hip solutions



### UNIVERSAL HipFast

#### Key components

	Code
Universal HipFast system (6m pack) comprises of:	34001
Hip roll (6m)	

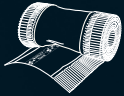

Hip batten brackets (6 No.)



Ridge unions (13 No.)



	Code
Universal HipFast Support Trays (6m)*	34002
9 No. HipFast Support Trays (715mm each)	



\* To be ordered separately

## Eaves solutions

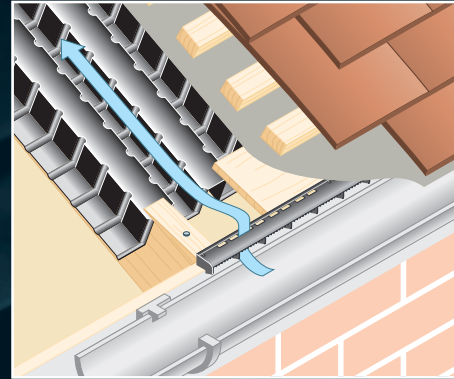

### UNIVERSAL 10mm eaves vent system

#### Key components

	Code
Universal 10mm eaves vent system (6m pack) comprises of:	46350
Eaves rafter roll (6m)	



Felt support tray (10 No.)



10mm strip ventilator (6 No.)

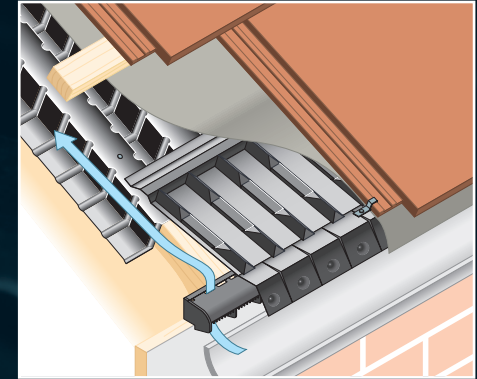
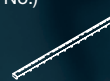

### UNIVERSAL 25mm eaves vent system

#### Key components

	Code
Universal 25mm eaves vent system (6m pack) comprises of:	46351
Eaves rafter roll (6m)	



Felt support tray (10 No.)



25mm strip ventilator (6 No.)

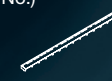

Also available:

Comb filler strip	30425
Continuous rafter roll pack	46323

## Let **ME** lighten your load

At times roofing and cladding specification can be complex and heavy going. That's why we're on hand to offer practical, experienced support in a host of useful ways. From creating bespoke NBS, BIM or CAD details to answering questions on any aspect of your roofing or cladding project. We will deliver urgent samples where and when they're needed and provide products that help you achieve an A+ rating. We're always happy to take the weight off your shoulders. Because with **ME**, it's all about you.

Trust **ME** to take the hassle out of specification. If you ever need advice on any cladding or roofing related issue, you can rely on our team to give you a helping hand.

Call **ME** on 01283 722588  
Email **ME** at [info@marleyeternit.co.uk](mailto:info@marleyeternit.co.uk)  
Or visit **ME** [www.marleyeternit.co.uk/me](http://www.marleyeternit.co.uk/me)

## UNIVERSAL Online

→ [www.marleyeternit.co.uk/universal/productselector](http://www.marleyeternit.co.uk/universal/productselector)



### Customer Services

Marley Eternit is committed to providing outstanding customer care and is staffed by experienced personnel in departments dedicated to providing the following services:

#### Advice, literature and samples

→ All current product and technical literature can be downloaded from [www.marleyeternit.co.uk/downloads](http://www.marleyeternit.co.uk/downloads)

To request samples and advice:

→ **T** 01283 722588 **E** [info@marleyeternit.co.uk](mailto:info@marleyeternit.co.uk)

#### Quotations and ordering information

→ **T** 01283 722588 **E** [info@marleyeternit.co.uk](mailto:info@marleyeternit.co.uk)

#### Stockist information

→ **T** 01283 722588 **E** [info@marleyeternit.co.uk](mailto:info@marleyeternit.co.uk)

### Training centre

We have a purpose-built training centre where we are able to impart our expertise through a range of practical and classroom courses.

→ **T** 01283 722588 **E** [info@marleyeternit.co.uk](mailto:info@marleyeternit.co.uk)

### Marley Eternit roofing ranges

- Clay and concrete plain tiles
- Fibre cement slates
- Interlocking slates
- Interlocking tiles
- Ventilation and dry fix roof accessories
- Fittings and accessories

Marley Eternit also offer comprehensive ranges of Claddings, Building Boards, Profiled Sheeting and accessories

Information for all these products is available on request.

→ **T** 01283 722588 **E** [info@marleyeternit.co.uk](mailto:info@marleyeternit.co.uk)

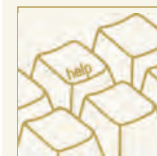

### Technical Advisory Service

Marley Eternit provides a free Technical Advisory Service which is staffed by personnel with specialist knowledge of the use of all Marley Eternit roofing products and systems. Services include:

→ **T** 01283 722588 **E** [info@marleyeternit.co.uk](mailto:info@marleyeternit.co.uk)

#### Fixing specifications

Bespoke fixing specifications can be provided, taking into account location, dimensions and degree of exposure for individual buildings.

→ [www.marleyeternit.co.uk/tilefix](http://www.marleyeternit.co.uk/tilefix)



#### Estimating tile quantities

Calculation of all materials required for any roofing project including tiles, battens, underlay, ancillary fittings and accessories.

→ [www.marleyeternit.co.uk/estimator](http://www.marleyeternit.co.uk/estimator)



#### National Building Specification clauses (NBS)

All essential clauses for Marley Eternit roof specifications are available, detailing all work items in section H65 'Single lap roof tiling' and H60 'Plain roof tiling' and H61 'Fibre cement slates'.

→ [www.marleyeternit.co.uk/specrite](http://www.marleyeternit.co.uk/specrite)



### Marley Eternit Assured Roofing Specification Scheme

Operated through Marley Eternit's Technical Advisory Service, this unrivalled and comprehensive advice and support service for specifiers of major roofing projects offers the following:

- In-depth technical advice
- Project-specific fixing specifications
- Project-specific NBS clauses

#### Level of cover

Marley Eternit offer 15 years cover for design performance, fixing specification and product durability when correctly installed in accordance with our recommendations and the requirements of BS 5534.



an **Etex** GROUP company