

Uniclass	EPIC
L384:P314:D32	C441:X342
CI/SfB	
32	(22.3) Xo



# Orbis

## Single glazed partitioning system

Love the space you're in.

# Specialist expertise

Komfort specialise in the design and production of commercial glazed and solid partitioning (including demountable), laminate & veneered doors, movable walls and storage wall.

As the UK's leading supplier of partitioning systems, we provide solutions to the commercial interiors sector which range from traditional design to modern contemporary styles. All our systems are compliant with current building regulations and suitable for any office fit-out or refurbishment.

As part of our continuing commitment to delivering exceptional service we offer specialist expertise in the following areas:

## Structural strength, fire and acoustic performance

To guarantee the safest and widest product offering in the UK's commercial interiors sector and provide peace of mind, we operate an uncompromising programme of product testing.

Our glazed and solid, fire and non-fire rated partitioning and doors are independently tested at authorised laboratories in accordance with the relevant British Standard.

## Technical knowledge

Through our long term product research, development and experience supplying complex and large projects, we have established an unrivalled understanding of the needs of the contractor and end user.

Our logistics expertise, scaled with dedicated project management, supports monitoring manufacturer deadlines and schedules from order through to production and delivery.

## Ongoing investment

We invest in extensive stock to ensure the widest selection of products, supported by specialist distribution to offer delivery in consolidated loads, thereby reducing disruption and minimising environmental impact.

## Tooling and manufacturing facilities

Our extensive ongoing investment, means we are able to deliver cost effective, high quality products under-pinned by continual enhancements to service.

- Full accreditation to BS EN ISO 9001, 14001 and OHSAS 18001.
- Full IFC certification for FD30 and FD60 30 and 60 minute fire rated doors and door kits.
- FSC certification.
- Carbon Trust Standard.
- NBS Plus clauses.
- BRE Green Guide/Ska rating A and A+.

## Outstanding service

Our portfolio of support services is available throughout the duration of the project and includes:

- Estimates
- Technical support and guidance
- Web accessible technical documentation including junction drawings in CAD and PDF formats
- Certification and installation statements
- Sales support
- Site surveys for glass and blinds
- Product installation training
- NBS specifications
- Dedicated specifiers support line
- RIBA approved CPD seminars

## Our products

### Partitioning Systems

- Ls90
- Single/Double Glazed Polar
- Polar Vision
- PolarTec
- Polar 100
- Orbis
- Klassic
- Komfire 75 & 100
- Kameo 75
- 600 Series
- Confluence
- KM<sup>3</sup> Storage wall
- Movable Walls 80 & 200

### Doors

- Veneered
- Glass
- Laminate
- Door Furniture

### SwitchGlass

### Blinds and Graphics

### Manifestation

### Architectural Glass and Firescreens

## Creating a workspace and looking for project inspiration?

Komfort has showrooms located in London, Leeds and Scotland which are used by architects, designers and contractors.

To find out more or arrange a visit, email [general@komfort.com](mailto:general@komfort.com)



# Orbis

Single glazed partitioning system

## Contents

04	Orbis
06	Jointing
07	Door Options
08	Glass Doors & Ironmongery
10	Isometric
11	Components



# Orbis

Komfort Workspace, the UK's market leader in the design and manufacture of commercial glazed and solid partitioning is delighted to introduce Orbis, its new single glazed partitioning system.

Orbis is the perfect glazed partitioning system for normal office use where standard performance is the prerequisite.

Sleek, symmetrical head and base tracks, complemented by a slim aluminium door frame and crystal clear dry joints, give the system a minimalist appearance. A choice of frame colour and several glass or

veneered door options can be combined to create stylish and modern office spaces.

Backed by Komfort's trusted reputation and installed only by Komfort trained fitters, Orbis has to be the number one choice where affordable quality and style is paramount.

## Setting the new standard

- Sleek, minimalist appearance - head and base track are both just 23mm in height
- Crystal clear PETg low profile dry joint
- Aluminium track available ex-stock in white or silver
- Choice of three glass door options and four veneered door options
- Meets BS and Document N performance requirements for normal office use
- Installed by Komfort trained fitters



# The System

## Performance

Orbis can achieve up to 33dB (Rw) with 10mm or 12mm thick toughened safety glass. The single glazed system meets the requirements for normal office use based on British Standards and Document N of the Building Regulations.

## Framing Finish

The aluminium framing is available in white powder coated RAL 9010 and silver RAL 9006.

Additional colours are available on request.

## Glass Type

Non-performance clear toughened safety glass to the following sizes:

- 10mm – maximum height 2700mm
- 12mm – maximum height 3000mm
- Maximum module width is 1200mm

## Options

- Choice of three standard glass door options and four veneered door options
- Range of ironmongery compliant with Part M requirements

## Order / Installation Process

- Place order with our estimating team with a sketch of requirements showing approximate dimensions
- A site survey will be carried out on most installations prior to track installation. Track and glass will be installed simultaneously where possible
- Track, glass, glass doors, ironmongery and manifestation will be installed by Komfort trained fitters
- Project sign-off and acceptance as complete



# Jointing

The crystal clear PETg trim is a low profile glass-to-glass dry joint that is used instead of traditional silicone. Trims are available in four options:

- Straight glass-to-glass junction
- 90 degree corner junction
- 135 degree corner junction
- 3-way junction

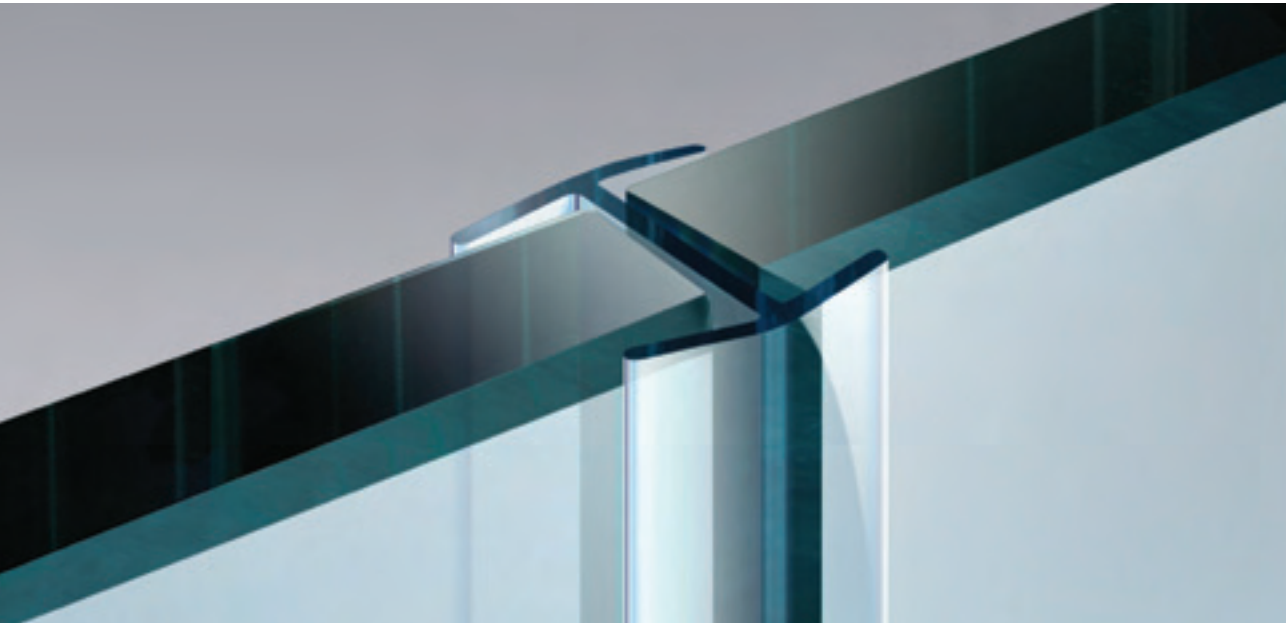
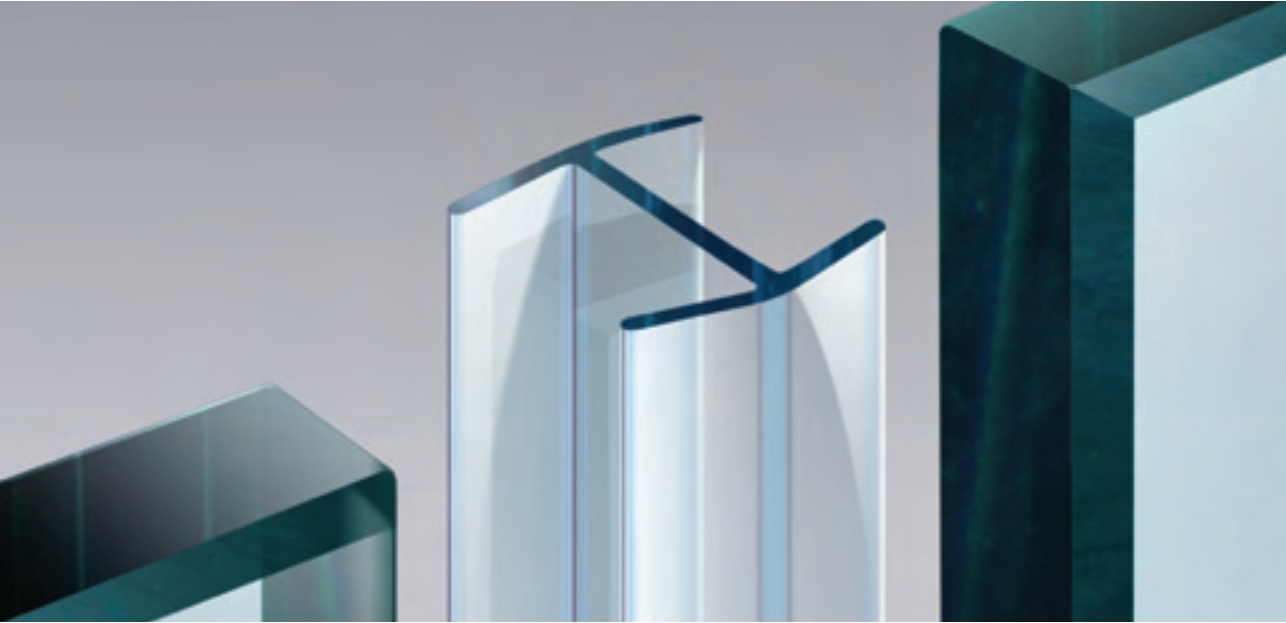
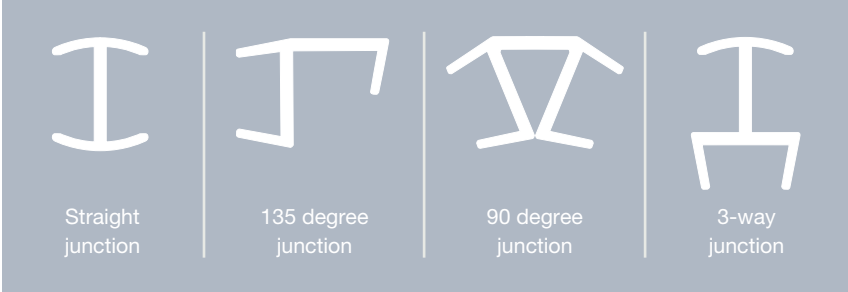

# Door Options

## Glass Door Options



- Manufactured in clear toughened safety glass with polished edges
- Can either be installed into the aluminium frame or as a frameless option

### Choice of three options

- 1 Framed glass door with glass overpanel
- 2 Full height framed glass door
- 3 Full height frameless glass door up to a maximum height of 3000mm

Sliding glass door available on request.

## Veneered Door Options



- 44mm thick solid core veneered or laminated door
- Can be installed full height or with matching overpanel into the aluminium door frame

### Choice of four options

- 1 Veneered door with glass overpanel
- 2 Standard height veneered door (1981mm or 2040mm) to a maximum height of 3000mm
- 3 Full height veneered door
- 4 Full height veneered door (2400mm - 2700mm) with veneered overpanel to a maximum height of 3000mm

# Manifestation



Film applied to meet the requirements of Part M of the Building Regulations



Minimum of 50mm in height



# Framed Glass Doors & Ironmongery

## Option 1

### Framed glass door with glass overpanel

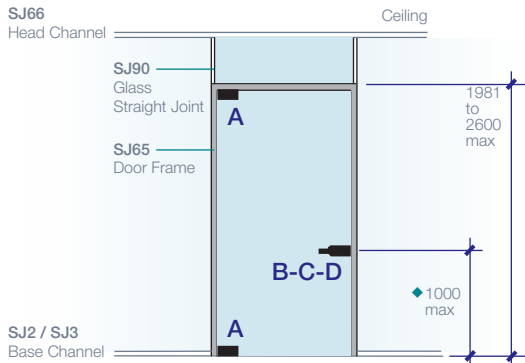

LMG19.83 - SJ65 door frame: 838 x 1981mm max height or  
 LMG26.90 - SJ65 door frame: 900 x 2600mm max height

Item	Part No.	Description	Quantity
A	K590.15	Top/ Bottom Patch Pivot	1 set
B	K310.15	Patch Lock	1
C	K750	Lever	1 set
D	G918	Euro Cylinder/Thumbturn	1

Optional door ironmongery

◆E	G942.300	300mm 'D' Handle	1 set
◆F	G942.600	600mm 'D' Handle	1 set
	G950	Door Closer	1



## Option 2

### Full height framed glass door

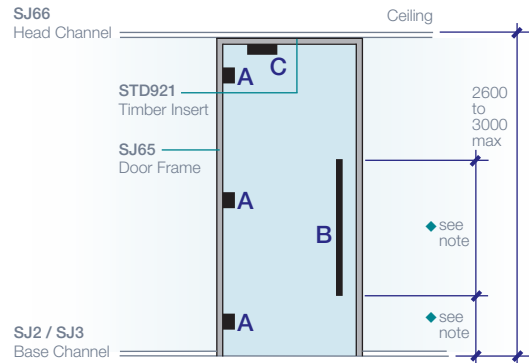

LMG30.90 - SJ65 door frame: 900 x 3000mm max height

Item	Part No.	Description	Quantity
A	K505	Patch Hinge	3
B	G942.600	600mm 'D' Handle	1 set
C	G950	Door Closer	1
-	STD921	Timber Insert	1

Optional door ironmongery

◆D	MSDG.7	720mm 'D' Handle	1 set
◆E	MSDG.12	1240mm 'D' Handle	1 set
◆F	MSDG.17	1760mm 'D' Handle	1 set

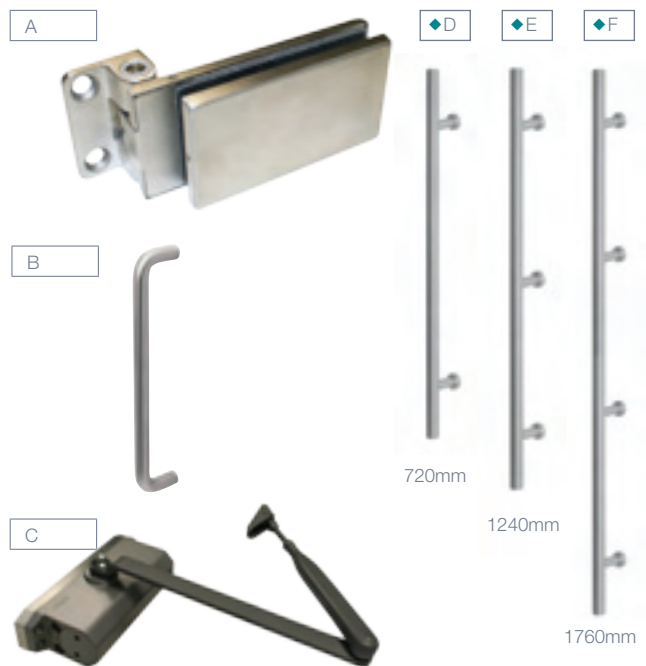



# Frameless Glass Door & Ironmongery

## Option 3

### Full height frameless glass door

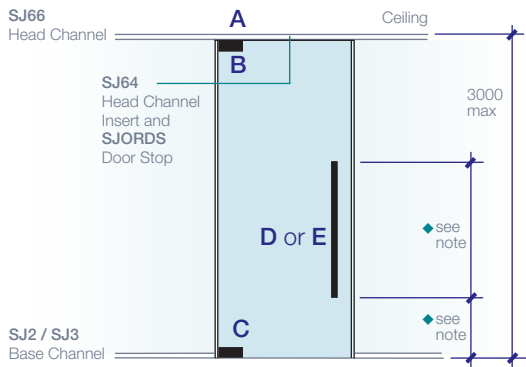

No Door Frame - 900 x 3000mm max height

Item	Part No.	Description	Quantity
A	LMSJ22/23PK	Top Pivot Assembly	1
B	TMPF	Top Mounted Pivot Fitting	1
C	SCFMP	Self Closing Floor Mtg. Pivot	1
-	SJ64	Head Channel Insert	1
-	SJORDS	Door Stop	1

Select handle to suit door height  
item D for height max 2800mm, item E for height max 3000mm

◆D	MSDG.7	720mm 'D' Handle	1 set
◆E	MSDG.12	1240mm 'D' Handle	1 set

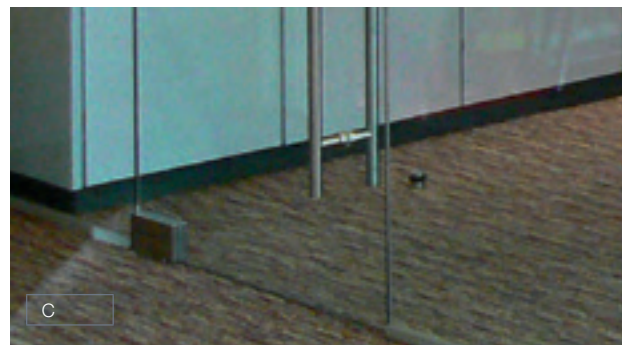
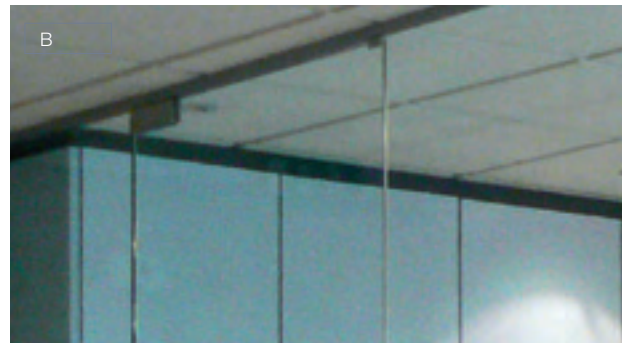

B



C



◆D



720mm

◆E



1240mm

## Benefits

- Floor mounted - eliminates the requirement to fit a coffer box and floor spring
- Fast installation
- Self closing and hold open action

Note:

Maximum permissible door assembly weight with ironmongery installed must not exceed 80kg for Options 1 & 2 and 90Kg for Option 3

- ◆ Dimension subject to door furniture option selected

# Orbis Isometric

Note:

The following glass to glass joint options are available but not shown:

- 90 degree Joint
- 135 degree Joint
- 3 Way Joint

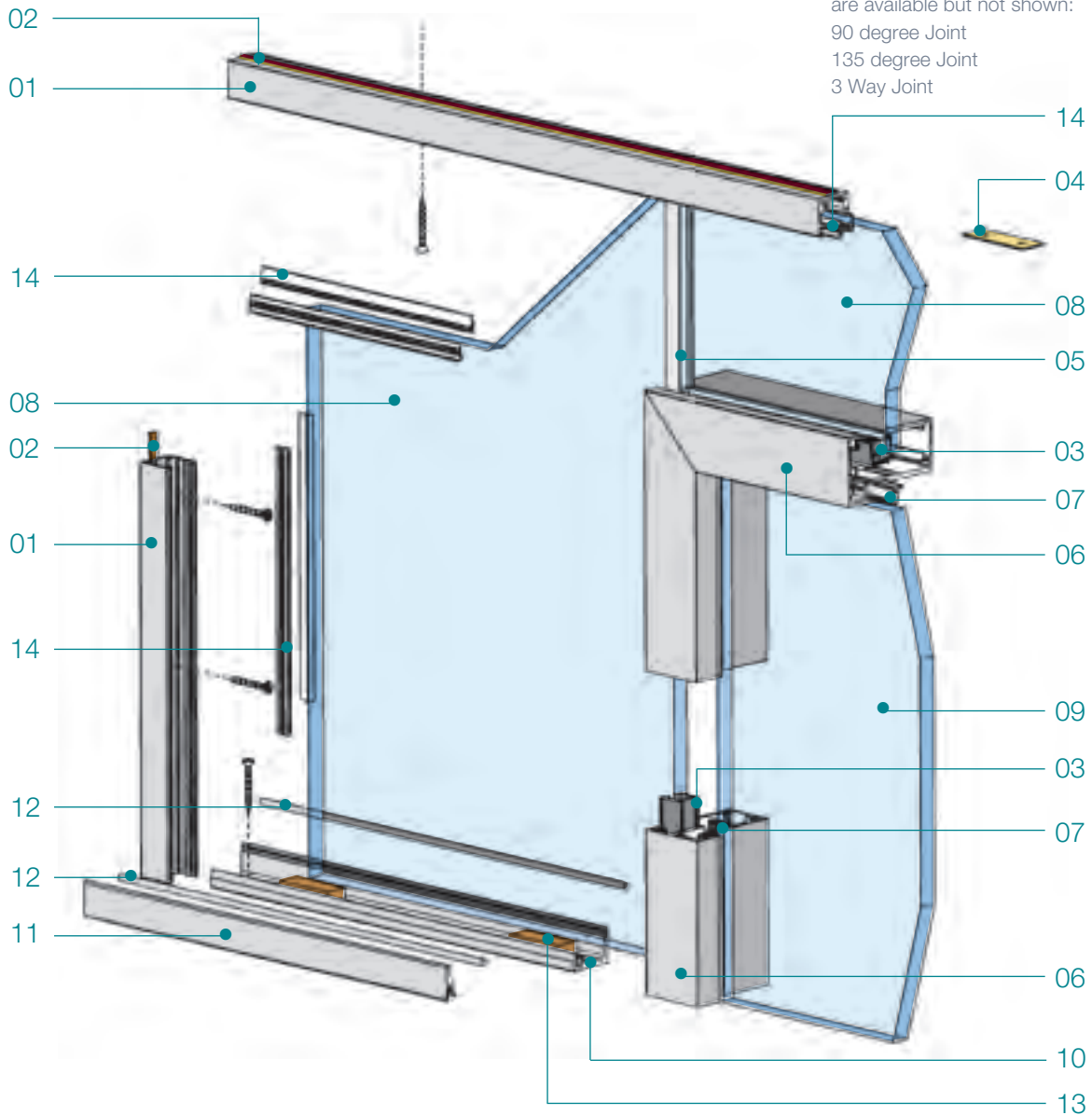



Crystal clear dry jointed system with square aluminium sections









- 01 Head / abutment channel - SJ66
- 02 Abutment seal - 342
- 03 PVCu glazing channel - SJ36
- 04 Straight jointing cleat - SJ.JC1
- 05 PETg straight glazing joint - SJ90

- 06 Aluminium door frame - SJ65
- 07 Door frame seal - PSQ21
- 08 10mm / 12mm toughened safety glass
- 09 10mm / 12mm toughened safety glass door
- 10 Base channel - SJ2



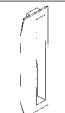

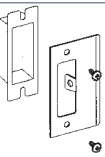



- 11 Base channel leg - SJ3
- 12 Glazing bead - SJ11 / SJ12
- 13 Glass packer
- 14 Glass glazing gasket - SJ73 / SJ74





# Orbis Components

Aluminium Vertical & Horizontal Sections		
PROFILE	CODE	DESCRIPTION
	SJ66	Head Channel
	SJ2	Base Channel
	SJ3	Base Channel Leg

Door Frame Components		
PROFILE	CODE	DESCRIPTION
	SJ65	Door Frame
	SJ67*	Door Frame Base Bracket
	SJ68*	Cast Lockbox Fixing Bracket
	SJ64	Head Channel Insert use with frameless full height glass doors
	586LRG*	Cast Lockbox / Striker for use with timber doors
	812L*	Door Frame Cleat
	PSQ21*	Door Frame Gasket
	SJAGD*	GDS Striker & Back Box Kit for use with glass doors includes ADGS - striker plate. ADGSBB - backbox ADG/S - screws
	SJORDS	Door Stop use with frameless full height glass doors

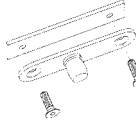
\* Supplied with door frame

Glazing Sections		
PROFILE	CODE	DESCRIPTION
	SJ11	4mm dia Base Channel Gasket
	SJ12	5mm dia Base Channel Gasket
	SJ36	Glazing Channel Gasket
	SJ73	10mm Glass Glazing Gasket
	SJ74	12mm Glass Glazing Gasket
	SJ90/10	10mm Glass Straight Joint
	SJ90/12	12mm Glass Straight Joint
	SJ91/10	10mm Glass 90° Corner Joint
	SJ91/12	12mm Glass 90° Corner Joint
	SJ92/10	10mm Glass 135° Corner Joint
	SJ92/12	12mm Glass 135° Corner Joint
	SJ93/10	10mm Glass 3-Way Corner Joint
	SJ93/12	12mm Glass 3-Way Corner Joint

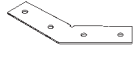
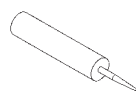
Miscellaneous Items		
PROFILE	CODE	DESCRIPTION
	LMSJ22PK	Top Pivot & Fixing Plate Kit includes LMSJ 22 - pivot plate LM SJ23 - fixing plate M6 cap screws
	342	Head Channel Abutment Foam
	SJ.JC1	Straight Joint Cleat for SJ66 Head Channel
	SJ.JC2	90 degree Joint Cleat for SJ66 Head Channel
	SJ.JC3	135 degree Joint Cleat for SJ66 Head Channel
	SILICONTHN	Translucent Silicon Sealant

Love the space you're in.

## Sales Offices

### Head Office – Horsham

Ashurst  
Broadlands Business Campus  
Langhurstwood Road  
Horsham  
West Sussex  
RH12 4QP  
Tel: 01403 390300  
Fax: 01403 218828  
E-mail: [general@komfort.com](mailto:general@komfort.com)

### Leeds

Unit 2  
Intermezzo Drive  
Stourton Link  
Leeds  
West Yorkshire  
LS10 1DF  
Tel: 0113 395 6565  
Fax: 0113 395 6566  
E-mail: [northern-sales@komfort.com](mailto:northern-sales@komfort.com)

### Birmingham

Unit 2  
Rabone Park  
Rabone Lane  
Smethwick  
Birmingham  
B66 2NN  
Tel: 0121 555 0300  
Fax: 0121 555 0301  
E-mail: [midland-sales@komfort.com](mailto:midland-sales@komfort.com)

### Republic of Ireland

Tel: +353 (0)1 6099126  
Fax: +353 (0)1 6099110  
E-mail: [dublin-sales@komfort.com](mailto:dublin-sales@komfort.com)

### Southern Sales Counter

Unit 10  
Gatwick Distribution Centre  
Whittle Way  
Crawley  
West Sussex  
RH10 9RT  
Tel: 01293 577890  
(for stock/sales counter enquiries only)

### Internet

[www.komfort.com](http://www.komfort.com)

### Showrooms

#### London

14 Bonhill Street  
London  
EC2A 4BX  
Tel: 0207 256 5701  
Fax: 0207 374 8649  
E-mail: [london.showsuite@komfort.com](mailto:london.showsuite@komfort.com)

#### Leeds

Unit 2  
Intermezzo Drive  
Stourton Link  
Leeds  
West Yorkshire  
LS10 1DF  
Tel: 0113 395 6565  
Fax: 0113 395 6566  
E-mail: [leeds.showsuite@komfort.com](mailto:leeds.showsuite@komfort.com)

#### Scotland

The Skyhouse  
18 Elliot Place  
Glasgow  
G3 8EP  
Tel: 0113 395 6565  
Fax: 0113 395 6566  
E-mail: [scotland.showsuite@komfort.com](mailto:scotland.showsuite@komfort.com)



Scan the QR code to automatically download Komfort's Head Office contact details direct to your smart device. To download a QR scanner visit the relevant app store to correspond with your device.

ID Number: KOMORBIS 04/12

Find us on:

Facebook  Twitter  YouTube 

Part of the Laidlaw Interiors Group

