

SCISSOR LIFTS

GLP35

ML40/50, M50



GLP35

THE LOW-PROFILE DOUBLE SCISSOR LIFTS GLP35 WERE DESIGNED ESPECIALLY FOR THE SERVICE AREA. THE LOW CLOSED HEIGHT MEANS THE LIFT CAN BE SURFACE MOUNTED, BECAUSE NO RECESS IS REQUIRED THE LIFT CAN EASILY BE REPOSITIONED OR MOVED IN THE FUTURE.

The hydraulic synchronization system with automatic leveling function prevents uneven lifting or lowering of the load.

The integrated emergency lowering device allows the lift to be lowered in the event of a power failure. The lift itself is operated from a safe distance via the operating panel.

A long lifetime is the main focus of rust protection - which is achieved among others by the standard powder coating.

Robust pushbuttons ensure smooth operation of the lift.



The control console features an integrated hydraulic unit and thus considerably helps reduce the maintenance effort.

There are no mechanical connections between the platforms, which provides for perfect workspace ergonomics and maximum freedom of action underneath the vehicle.

Non-contact inductive proximity switches provide for reliable functioning even in harsh environments. Moreover, there is no mechanical wear.

The figure shows GLP35

DETAILS

Two independently operating hydraulic circuits with a total of 4 lifting cylinders eliminate the need for additional safety catches. Thus, GLP scissor lifts can be operated without auxiliary compressed air supply.

The low drive over height facilitates the support of vehicles with low ground clearance.

The GLP double scissor lift range features extendable stepless platforms to accommodate long and short wheel base vehicles.

For optional inground installation, spacer boxes are supplied to allow the lift to be lowered with the platforms extended.

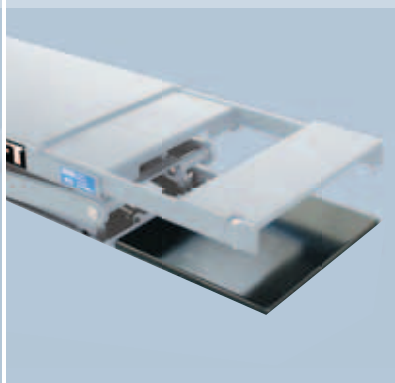
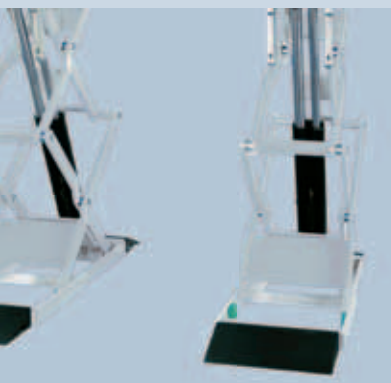

Model:	GLP35
Capacity	3500kg
A. Stroke	1920 mm
B. Overall length short/ long drive on ramps	2100/3500 mm
C. Overall width	2050 mm
D. Closed height	125 mm
E. Platform length	1500-2000 mm
F. Platform width	625 mm
Motor performance	3 kW
Electrical connection (3 phases)	230/400 V, 50 Hz
Lifting time	45 sec.
Lowering time	45 sec.
Weight	950 kg

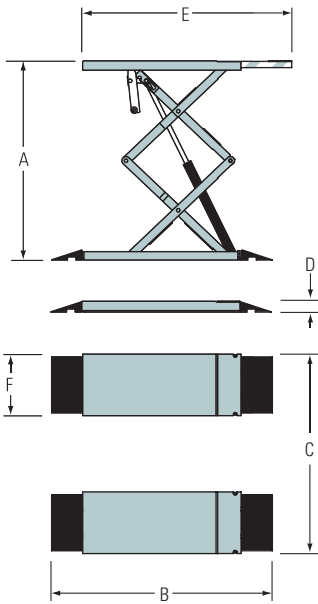

GLP35 with short drive on ramps

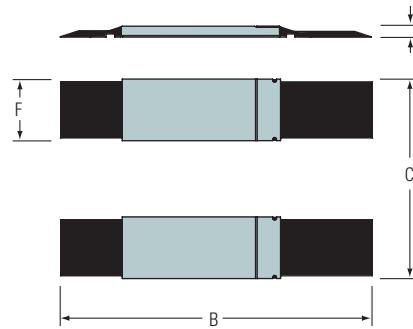

GLP35 with long drive on ramps

OPTIONS

Short drive on ramps (300 mm)

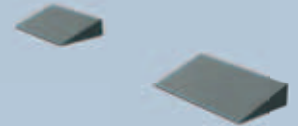

ACCESSORIES

4 rubber bases, height 80 mm



Long drive on ramps for sports cars (1000 mm)

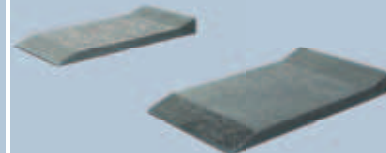

Cross piece for supporting vehicles with pick up points located in between the two platforms



In ground installation kit

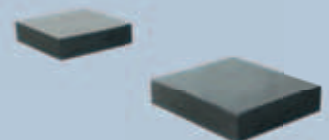

ML40/50

ON ACCOUNT OF ITS MODULAR AND FLAT DESIGN THE NEW ML INGROUND SCISSOR LIFT COMBINES A WIDE RANGE OF APPLICATION OPTIONS AT A FAVOURABLE PRICE. LIKE ITS BIG „SISTER“ M50, THE ML IS ALSO EXTREMELY SUITABLE FOR THE RECEIVING AREA AND FOR WHEEL ALIGNMENT WORK.

The hydraulic synchronization system in crossed master-slave construction prevents uneven lifting or lowering of the load.

All hydraulic cylinders are screwable. This reduces the number of welding joints and increases serviceability.

A long lifetime is the main focus of rust protection - which is achieved among others by the standard powder coating.

The integrated emergency lowering device allows the lift to be lowered in the event of a power failure. The lift itself is operated from a safe distance via the operating panel.

Robust pushbuttons ensure smooth operation of the lift.

The control console features an integrated hydraulic unit and thus considerably helps reduce the maintenance effort.

The dispensing with electric modules at the lift increases reliability. Leveling and monitoring are centralized via control panel.

Safety comes first. The platforms are constantly monitored. Auto cut-out is immediately activated at a high difference of ± 50 mm or more.

The figure shows ML40LT-42

DETAILS

To facilitate flexible support of small as well as large vehicles, the lifting tables of all the LT models are equipped with extensible platform elongations.

The main cylinder as well as the lifting cylinders of the lifting table are equipped with a drop-off facility that can be locked pneumatically. This guarantees exact axle measuring and a high degree of safety at the workplace. Moreover, the toothed racks are of screw-type design which allows an individual adjustment.

Models with axle measuring kit feature a 50 mm high sheet metal structure with recesses incl. ergonomically designed filling plates for different wheelbases. (optional)

The manually lockable moveable plates integrated in the metal structure are for models with axle measurement kit, designed for comfortable axle measurement work. The special bearing guarantees reliable operation and a long life cycle. (optional)

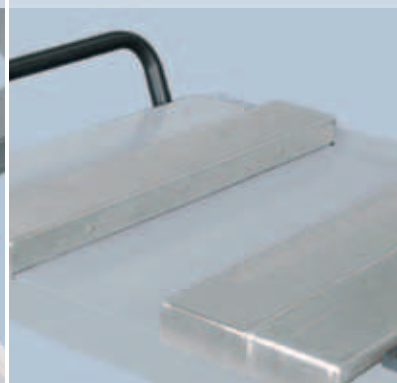
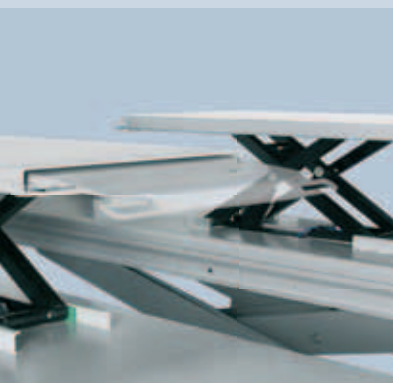

Model:	ML40N-42	ML50N-48	ML40LT-42	ML50LT-48
Capacity/ lifting table	4000 kg	5000 kg	4000/3500 kg	4000/3500 kg
A. Stroke	1800 mm	1800 mm	1800 mm	1800 mm
B. Lifting table stroke	-	-	450 mm	450 mm
C. Overall length ascending ramps	5800 mm	6400 mm	5800 mm	6400 mm
D. Overall width	2300 mm	2300 mm	2300 mm	2300 mm
E. Ascending height	190 mm	200 mm	190 mm	200 mm
F. Platform length	4200 mm	4800 mm	4200 mm	4800 mm
G. Platform length, lifting table	-	-	1450-1970 mm	1450-1970 mm
H. Platform width	725 mm*	725 mm*	725 mm*	725 mm*
I. Platform width, lifting table	-	-	640 mm	640 mm
Motor performance	3 kW	3 kW	3 kW	3 kW
Electrical connection (3 phases)	230/400 V, 50 Hz	230/400 V, 50 Hz	230/400 V, 50 Hz	230/400 V, 50 Hz
Compressed air connection	6-8 bar	6-8 bar	6-8 bar	6-8 bar
Lifting time	45 sec.	45 sec.	45 sec.	45 sec.
Lifting time, lifting table	-	-	15 sec.	15 sec.
Lowering time	45 sec.	45 sec.	45 sec.	45 sec.
Lowering time, lifting table	-	-	20 sec.	20 sec.
Weight	1800 kg	1900 kg	2200 kg	2300 kg

* Dimensions incl. rails for jacking beam

N Standard scissor lift
LT With lifting table

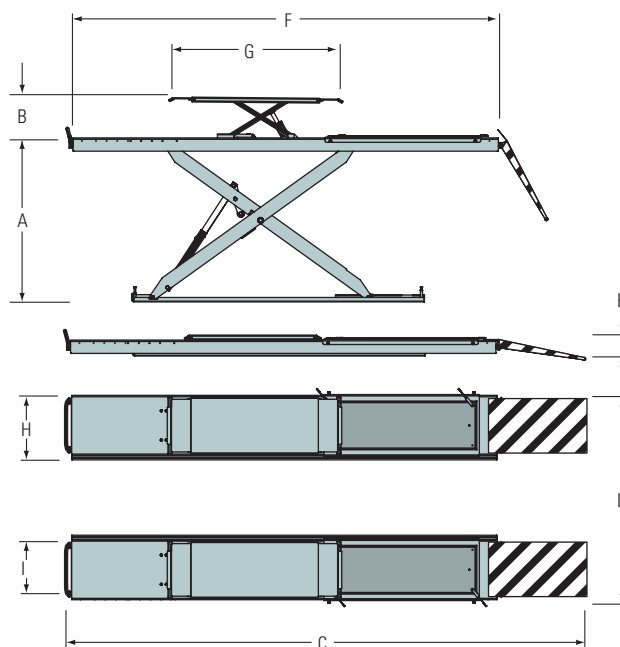

The run-up yokes on the face of the drive surface are hinged, an important prerequisite for axle measuring with cramped front wheels.



ACCESSORIES

Jacking beam, capacity 2600 kg



Long ramps with surface-mounted lifts (1600 mm)

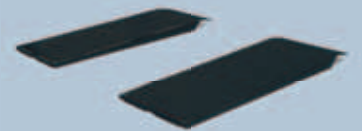

Short ramps with surface-mounted lifts (1000 mm)



4 rubber bases, height 40 mm

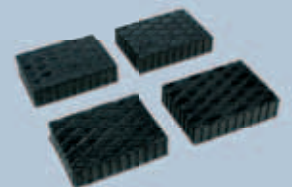

Axle measuring kit

Lighting kit made up of 2 fluorescent tubes

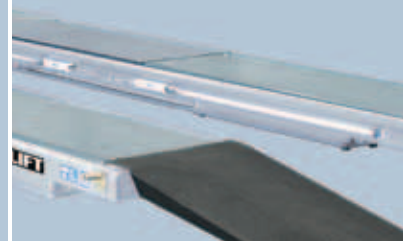

M50

IN GROUND SCISSOR LIFTS OF THE M50-SERIES ARE TAILORED FOR THE RECEIVING AREA AND FOR AXLE MEASURING. DEPENDING ON THE AREA OF APPLICATION, THE M50-SERIES IS AVAILABLE IN FOUR BASIC CONFIGURATIONS AND TWO DIFFERENT PLATFORM LENGTHS.

The hydraulic synchronization system in master-slave construction prevents uneven lifting or lowering of the load.

All hydraulic cylinders are screwable. This reduces the number of welding joints and increases serviceability.

A long lifetime is the main focus of rust protection - which is achieved among others by the standard powder coating.

The integrated emergency lowering device allows the lift to be lowered in the event of a power failure. The lift itself is operated from a safe distance via the operating panel.

Robust pushbuttons ensure smooth operation of the lift.

The control console features an integrated hydraulic unit and thus considerably helps reduce the maintenance effort.

Non-contact inductive proximity switches provide for reliable functioning even in harsh environments. Moreover, there is no mechanical wear.

Safety is an essential factor. The platforms are constantly monitored via a light barrier. As of a height difference of ± 50 mm, the automatic switchoff is immediately enabled.

The figure shows M50LTAT-46

DETAILS

To facilitate flexible support of small as well as large vehicles, the lifting tables of all the LT models are equipped with extensible stepless platform elongations.

The main cylinder as well as the lifting cylinders of the lifting table are equipped with a drop-off facility that can be locked pneumatically. This guarantees exact axle measuring and a high degree of safety at the workplace.

All the AT models are characterized by recesses integrated into the drive surface for supporting rotary plates. Filler sheets are used for adoption to different wheel bases.

Integrated sliding plates that can be locked pneumatically are the basis for effortless axle measuring. The special plastic roller bearing assembly provides for reliable functioning and a long life cycle.

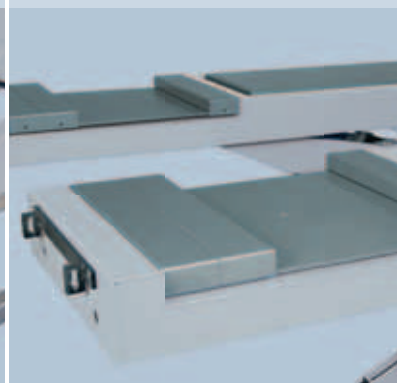
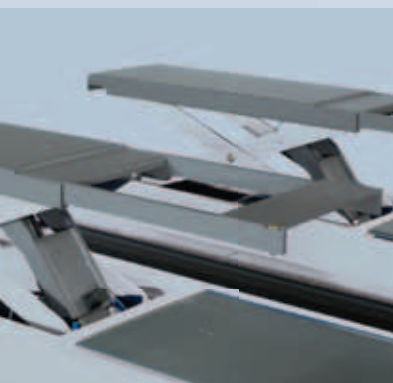

Model:	M50N-46	M50N-52	M50NAT-46	M50NAT-52	M50LT-46	M50LT-52	M50LTAT-46	M50LTAT-52
Capacity	5000 kg	5000 kg	5000 kg	5000 kg	5000 kg	5000 kg	5000 kg	5000 kg
A. Stroke	1800 mm	1800 mm	1800 mm	1800 mm	1800 mm	1800 mm	1800 mm	1800 mm
B. Lifting table stroke	-	-	-	-	450 mm	450 mm	450 mm	450 mm
C. Overall length short/ long ascending ramps	6200/6600 mm	5400/5800 mm	6200/6600 mm	6800/7200 mm	6200/6600 mm	6800/7200 mm	6200/6600 mm	6800/7200 mm
D. Overall width	2300 mm	2300 mm	2300 mm	2300 mm	2300 mm	2300 mm	2300 mm	2300 mm
E. Ascending height	360 mm	360 mm	360 mm	360 mm	360 mm	360 mm	360 mm	360 mm
F. Platform length	4600 mm	5200 mm	4600 mm	5200 mm	4600 mm	5200 mm	4600 mm	5200 mm
G. Platform length, lifting table	-	-	-	-	1350-2100 mm	1350-2100 mm	1350-2100 mm	1350-2100 mm
H. Platform width	729 mm*	729 mm*	729 mm*	729 mm*	729 mm*	729 mm*	729 mm*	729 mm*
I. Platform width, lifting table	-	-	-	-	500 mm	500 mm	500 mm	500 mm
Motor performance	3 kW	3 kW	3 kW	3 kW	3 kW	3 kW	3 kW	3 kW
Electrical connection (3 phases)	230/400 V, 50 Hz	230/400 V, 50 Hz	230/400 V, 50 Hz	230/400 V, 50 Hz	230/400 V, 50 Hz	230/400 V, 50 Hz	230/400 V, 50 Hz	230/400 V, 50 Hz
Compressed air connection	6-8 bar	6-8 bar	6-8 bar	6-8 bar	6-8 bar	6-8 bar	6-8 bar	6-8 bar
Lifting time	45 sec.	45 sec.	45 sec.	45 sec.	45 sec.	45 sec.	45 sec.	45 sec.
Lifting time, lifting table	-	-	-	-	15 sec.	15 sec.	15 sec.	15 sec.
Lowering time	45 sec.	45 sec.	45 sec.	45 sec.	45 sec.	45 sec.	45 sec.	45 sec.
Lowering time, lifting table	-	-	-	-	20 sec.	20 sec.	20 sec.	20 sec.
Weight	1800 kg	1900 kg	1900 kg	2000 kg	2200 kg	2300 kg	2400 kg	2500 kg

* Dimensions incl. rails for jacking beam

N Standard wheel alignment without balance plate and without cut-out
AT for axle measuring
LT with lifting table
LTAT for axle measuring with lifting table

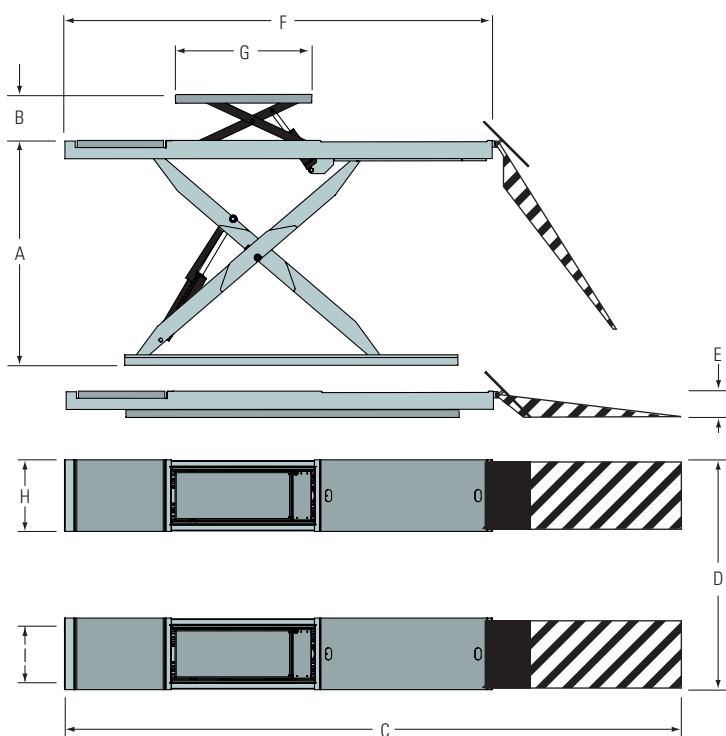

OPTIONS

Jacking beam, capacity 2600 kg



Lighting kit made up of 4 fluorescent tubes



ACCESSORIES

Short ramps with surface-mounted lifts (1600 mm)



Long ramps with surface-mounted lifts (2000 mm)



4 rubber bases, height 40 mm

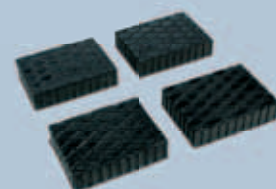

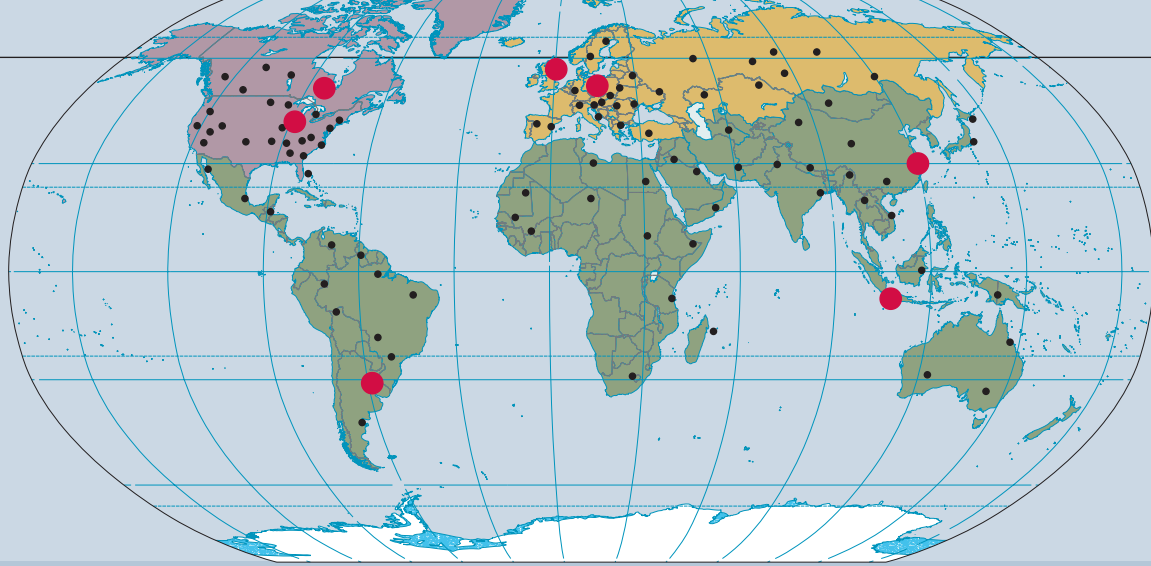

LOOK LOCAL - ACT GLOBAL

WE ACT WITH FOCUS ON OUR CUSTOMERS AND THEIR REQUIREMENTS. LOCAL SUBSIDIARIES WORLDWIDE PERMIT US TO DO SO, AND AT THE SAME TIME, OFFER A HIGH DEGREE OF PRODUCT FLEXIBILITY.

Rotary Lift's story of success started in 1924. Inspired by a barber chair rising in the air, company founder Peter Lunati developed the world's first vehicle lift. The lift could rotate. This design made it possible for vehicles to drive on and off the lift in forward gear. An important argument considering the frequent problem of reversing at that time. The patent for the lift was granted on September 1, 1925 and Rotary Lift – the company – was born.

Over 75 years later, Rotary Lift has grown to become the world leader in vehicle lift productivity. Apart from the headquarters in Madison, Indiana (USA) and the European Control Center in Bräunlingen, Germany, numerous global subsidiaries attend to the desires and requirements of our customers.

With this unique network, Rotary Lift has the opportunity of analyzing and recognizing market trends at an early stage and of applying that knowledge to generate global standards. Worldwide product releases of numerous vehicle manufacturers emphasize this approach.



Headquarter
Madison, IN USA

European Control Center
Bräunlingen, Germany

Rotatable
One of the first lifts of Rotary Lift



BlitzRotary GmbH
Hüfanger Straße 55
D-78199 Bräunlingen
A **DOVER** COMPANY

Fon +49.771.9233.0
Fax +49.771.9233.99
info@blitzrotary.com
www.blitzrotary.com

USA: +1.812.273.1622 (Headquarter)
Canada: +1.905.812.9920
United Kingdom: +44.178.747.7711
AustralAsia: +60.3.7660.0285

Latin America/Caribbean: +1.812.273.1622
Middle East/Northern Africa: +49.771.9233.0
Southern Africa: 1.812.273.1622
Brazil: +55.11.4534.1995

