

RACK DUAL and DOUBLE RACK

Linear rack actuators - Force in push action 650/1500 N - Stroke 180, 350, 550, 750 and 1000 mm

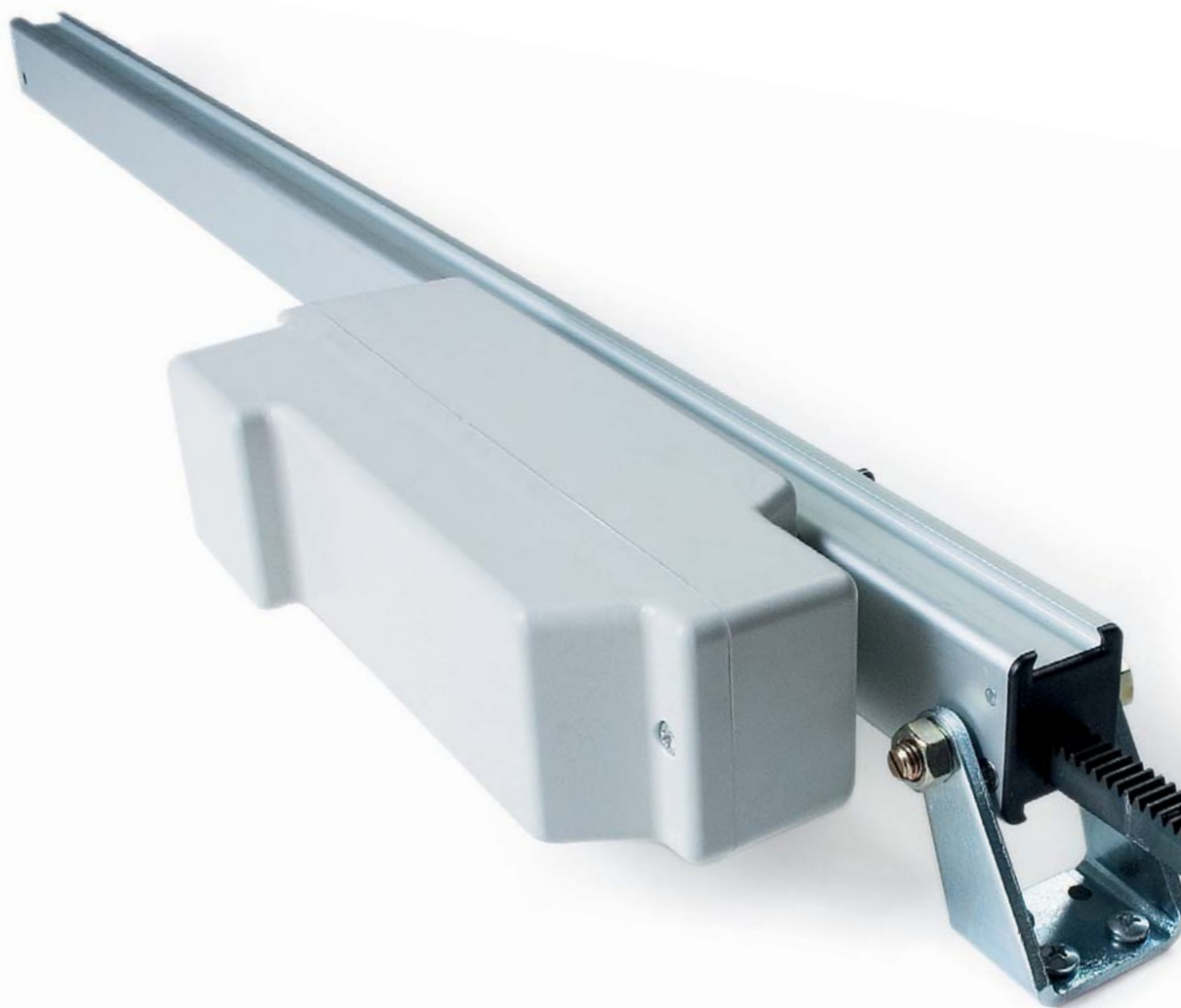

- 10 mm square rack transmission for stroke 180 mm, 350 mm, 550 mm and 12 mm square rack transmission for stroke 750 mm e 1000 mm.
- Supplied with 1,5 m cable.
- Available end brackets or sliding brackets (to be ordered separately); the dovetail slide allows the fixing on the whole length of the rack actuator.
- 24 Vdc version is suitable for installation on smoke and heat extraction systems in conformity to UNI EN 12101-2.
- (*) RACK 24 Vdc approved by **Istituto Giordano** (test report 243341)

MULTIPLE SYSTEMS

- To guarantee more push points on the same vent the rack actuator can be used either in the Dual Rack version with rack groups or in the Double rack version with auxiliary rack actuators; these systems, since guarantee stability, are particularly adapt to open domes and very large top hinged windows.
- **Dual Rack:** Force 650 N (230 Vac) - 750 N (24 Vdc) For each system assembly are necessary 1 Rack actuator, 1 Rack group, 1 connecting rod and 2 end brackets (part No. 40234E see following accessories)
- **Double Rack:** Force 1300 N (230 Vac) - 1500 N (24 Vdc) For each system are necessary 1 Rack actuator, 1 Auxiliary Rack actuator in parallel connection, 1 connecting rod, and 2 end brackets (part No. 40234E see following accessories)
- **Other multiple systems:**
It is also available a rack group double pivot for 3 or more push - points systems.

VOLTAGE SUPPLY
ELECTRIC CONNECTION
OPERATION
FORCE IN PUSH ACTION
FORCE IN PULL ACTION
SPEED
CURRENT ABSORPTION (with max load)
PARALLEL CONNECTION
LIMIT STOP
SAFETY STOP
SIGNAL LIMIT STOP POSITION
PROTECTION CLASS

RACK 230 V AC
230 Vac \pm 10%
3 wires + earth

650 N
350 N
~ 8 mm/s
0,1 A
YES
Electronic
Electronic

IP 55

COLOUR

SILVER ANODIZED

PART No.

STROKE 180 mm	(A = 400 mm)	40209F
STROKE 350 mm	(A = 570 mm)	40211T
STROKE 550 mm	(A = 770 mm)	40213V
STROKE 750 mm	(A = 970 mm)	40789D
STROKE 1000 mm	(A = 1220 mm)	40790E

Note: A = lenght of the actuator
(see next page)

RACK 24 V DC *
24 Vdc \pm 10%
3 wires
by polarity inversion
750 N
650 N
~ 8 mm/s
1 A
YES
Electronic
Electronic
open/close
IP 55

SILVER ANODIZED

40400A
40217D
40219H
40791F
40792G

Part. No

STROKE 180 mm
STROKE 350 mm
STROKE 550 mm
STROKE 750 mm
STROKE 1000 mm

RACK GROUP

40223B
40225D
40227F
40754U
40755V

RACK GROUP DOUBLE PIVOT

40379W
40380U
40381V
40851N
40852O

AUXILIARY RACK 230 VAC

40631P
40632S
40633U
40847J
40848K

AUXILIARY RACK 24 VDC

40636A
40637C
40638E
40849L
40850M

CONNECTING ROD:

Diameter 12 mm in stainless steel. Quick clutch: fixing accessories are not necessary.
Available lengths (distance between racks) are:

PART No.

1000 mm	40231B
1500 mm	40232C
2000 mm	40233D



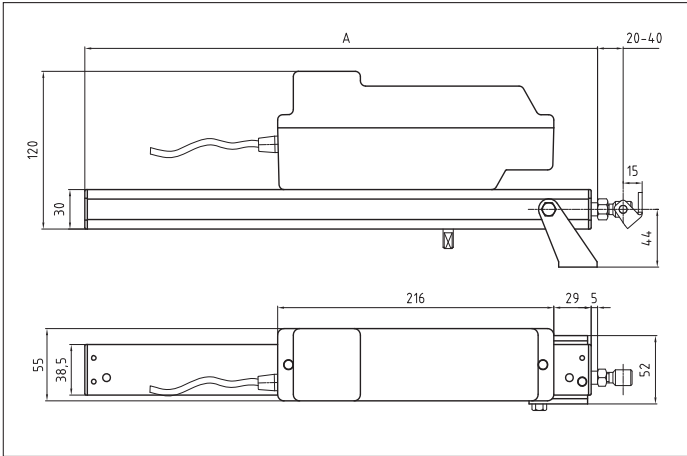
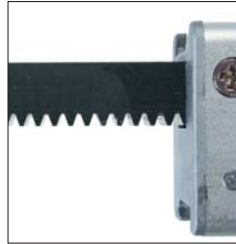

Rack actuator with sliding bracket part No. 40235F

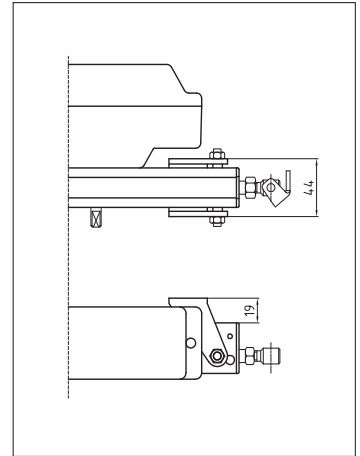

Rack actuator with end bracket part No. 40234E

Accessories

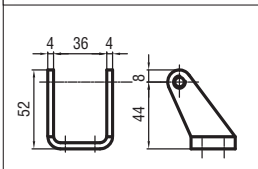
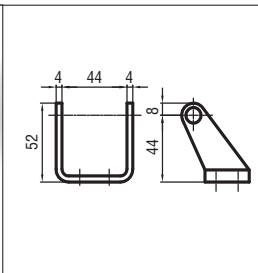

Galvanized steel sliding bracket part No. 40235F. It allows the fixing for the whole length of the actuator. To use only for single Rack.

Galvanized steel connector kit to fix the rack on the vent.

Galvanized steel end bracket part No. 40234E. To use for Dual Rack and Double Rack system or single Rack.

Installation examples

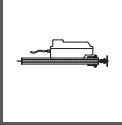

Single rack

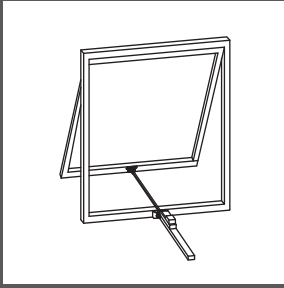

On top hinged window without windowsill with front fixing through sliding bracket part No. 40235F

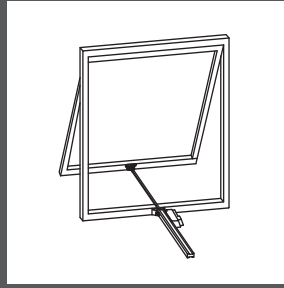

On top hinged window without windowsill with front fixing through end bracket part No. 40234E

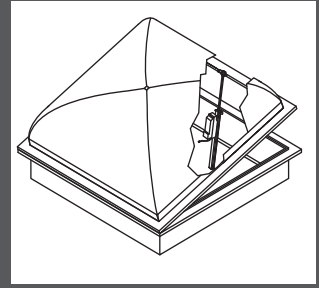

On domes with front fixing through sliding bracket part No. 40235F

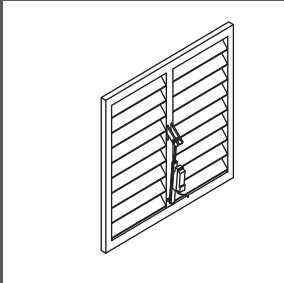

On horizontal louvers with back fixing through sliding bracket part No. 40235F

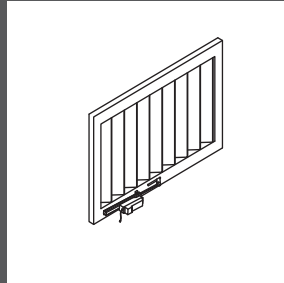

On vertical sun blades with back fixing through sliding bracket part No. 40235F

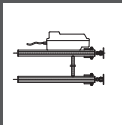

Dual Rack

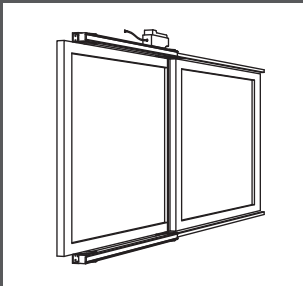

Installation of the Dual Rack on sliding windows with end bracket part No. 40234E and connection of the two actuators through rod

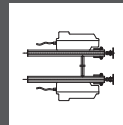

Double Rack

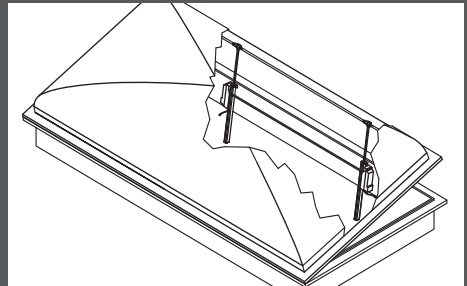

Installation of the Double Rack on domes with end bracket part No. 40234E and connection of the two actuators through rod

 The instructions for a safe installation are included in the section "SECURITY WARNINGS"

SPECIFICATION PROSPECTS

RACK

Electric linear actuator Ultraflex Control Systems. Available strokes 180, 350, 550, 750 or 1000 mm. Voltage supply: 230 Vac or 24 Vdc. Electronic safety limit stop and electronic stop in the intermediate positions. Parallel connection. Colour: silver anodized.

DUAL RACK

System with a second push point composed by one Rack Actuator, one Rack Group, and a connecting rod. Force 650 N/750 N

DOUBLE RACK

System with a second push point composed by one Rack Actuator, one auxiliary Rack and a connecting rod. Force 1300 N/1500 N. Systems with more than two push points can be obtained putting a Rack Group double pivot. Rack 230 Vac and Rack 24 Vdc are conform to 2004/108/CE directive, the 230 Vac version is also conform to 2006/95/CE directive.