



HEALTHCARE PRICE LIST

SEPTEMBER 2011

HYGIENIC SHELVING SYSTEMS - WIRE FORMAT

Bright chrome wire



- Bright chrome wire, open-deck design shelves.
- Bright chrome poles - grooved @ 25mm increments for shelf positioning.
- Load capacity 300kg per shelf.
- Usages - General stores.
Linen / laundry
Ward stores
Bulk stores
Catering facility
- Unsuitable for wet areas / chiller + humid environments.

Complete 3 tier units - 1650mm high

	300mm	400mm	500mm	600mm
600	£101	£112	£123	£137
800	£107	£118	£134	£148
900	£118	£123	£139	£150
1000	£126	£131	£150	£159
1200	£134	£139	£161	£181
1500	£159	£167	£186	£200
1800	£172	£186	£208	£219

Complete 4 tier units - 1800mm high

	300mm	400mm	500mm	600mm
600	£123	£139	£148	£164
800	£134	£148	£167	£178
900	£148	£156	£175	£191
1000	£153	£164	£178	£202
1200	£164	£172	£194	£216
1500	£197	£208	£235	£252
1800	£216	£235	£263	£279

Mobile option	£ set
125mm castors - all swivel / 2x braked	£83
100mm castors - all swivel / 2x braked	£67

Single shelves

	300mm	400mm	500mm	600mm
600	£29	£32	£32	£35
800	£32	£35	£35	£37
900	£35	£37	£37	£40
1000	£37	£40	£43	£45
1200	£40	£43	£48	£48
1500	£48	£51	£53	£56
1800	£51	£53	£56	£61

Nylon coated wire



- Nylon coated wire, open-deck design shelves.
- Nylon coating impervious to salts / acids / alkalines and blood.
- Bright chrome poles - grooved @ 25mm increments for shelf positioning.
- Load capacity 300kg per shelf.
- Usages - Clean / Dirty Utilities
Ward stores
Laboratory
Bulk / General stores
Coldroom / Freezer environments

Complete 3 tier units - 1650mm high

	300mm	400mm	500mm	600mm
600	£120	£123	£137	£145
800	£126	£131	£145	£159
900	£134	£142	£150	£170
1000	£142	£156	£170	£178
1200	£153	£167	£178	£186
1500	£175	£186	£205	£213
1800	£191	£211	£232	£243

Complete 4 tier units - 1800mm high

	300mm	400mm	500mm	600mm
600	£148	£156	£170	£183
800	£153	£164	£181	£197
900	£164	£175	£191	£208
1000	£178	£191	£205	£224
1200	£189	£205	£224	£241
1500	£222	£235	£257	£276
1800	£243	£263	£295	£312

Mobile option	£ set
125mm castors - all swivel / 2x braked	£83
100mm castors - all swivel / 2x braked	£67

Single shelves

	300mm	400mm	500mm	600mm
600	£32	£35	£37	£38
800	£37	£40	£40	£40
900	£40	£43	£43	£43
1000	£42	£45	£45	£48
1200	£43	£48	£51	£53
1500	£51	£53	£55	£60
1800	£53	£55	£63	£68

Accessories

Poles

	Chrome	St/St
300	£8	£13
600	£9	£16
900	£11	£19
1200	£13	£27
1650	£15	£32
1800	£16	£33
2000	£20	£37

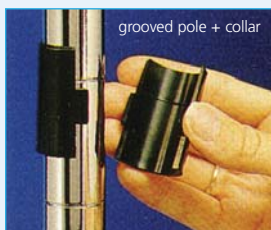

3-Sided stability frames - nylon

	300mm	400mm	500mm	600mm
600	£19	£22	£24	£25
800	£22	£25	£25	£27
900	£25	£28	£29	£31
1000	£28	£31	£31	£33
1200	£31	£33	£36	£39
1500	£39	£42	£44	£47
1800	£42	£44	£47	£50



Description	£
Shelf Hooks - nylon	£6
Post Clamps - chrome	£7
Post Clamps - St/St	£11
Label Holders	£3



HYGIENIC POLYMER MAT SHELVING SYSTEMS

MEDICAL SHELVING

METRO

Metromax Q-Polymer mat



- Removable polymer mats - louvred format with Microban protection.
- Powder coated wire shelf subframe for strength.
- Powder coated posts - grooved to accept plastic assembly collars.
- Unique design allows quick release for adjustment of shelves.
- Load capacity 300kg per shelf
- Usages - Equipment / Ward stores
Theatre stores
General stores
Laboratory
Coldroom / Freezer / Humid environments

Complete 3 tier units - 1600mm high

	457mm	533mm	610mm
610	£576	£643	£671
760	£593	£650	£676
914	£620	£665	£692
1070	£671	£721	£750
1220	£690	£739	£795
1370	£766	£811	£895
1525	£780	£825	£912
1830	£844	£951	£988

Complete 4 tier units - 1880mm high

	457mm	533mm	610mm
610	£709	£783	£839
760	£738	£805	£850
914	£752	£817	£862
1070	£850	£906	£967
1220	£865	£919	£980
1370	£967	£1,023	£1,141
1525	£980	£1,040	£1,160
1830	£1,068	£1,208	£1,297

Mobile option	£
125mm castors - all swivel / 2x braked	£158
100mm castors - all swivel / 2x braked	£144

Single shelves

	457mm	533mm	610mm
610	£133	£140	£168
760	£150	£160	£181
914	£165	£172	£199
1070	£179	£185	£217
1220	£185	£200	£229
1370	£193	£210	£236
1525	£200	£230	£248
1830	£224	£257	£309



Unique "quick release" design



hygienic, removable polymer mats



Label holder option fitted to shelf front

Aluminium / polymer mat shelving



- Removable polymer mats - louvred format.
- Anodised aluminium shelf subframe for strength.
- Anodised aluminium uprights allows adjustment of shelves @ 150mm increments.
- System allows continuous runs and infinite designs
- Load capacity up to 250kg per shelf
- Usage :- Equipment / Ward stores, Theatre stores, General stores, Laboratory
Coldroom / Freezer / Humid environments

Complete 4 tier units - 1700mm high

Lengths	373mm	475mm	577mm
684	£286	£300	£319
772	£300	£319	£333
862	£314	£333	£356
950	£325	£347	£361
1038	£336	£356	£375
1126	£347	£364	£389
1216	£361	£392	£417
1304	£375	£397	£425
1394	£397	£425	£444
1569	£417	£444	£467
1606	£525	£561	£583
1696	£553	£592	£614
1784	£561	£603	£633
1872	£575	£611	£642
1960	£583	£625	£658
2048	£589	£633	£667
2136	£603	£644	£686
2224	£611	£656	£694
2314	£625	£669	£711
2404	£647	£683	£728
2492	£664	£700	£742
2580	£675	£714	£758
2670	£689	£728	£786
2845	£728	£764	£811
2935	£769	£806	£856
3110	£814	£847	£881

Options	£
Mobile option 125mm castors	£99
Mobile option 100mm castors	£85
Drawer runner + 100mm poly pan	£89



Drawer unit for storage of single items



Compatible with gastro pan storage

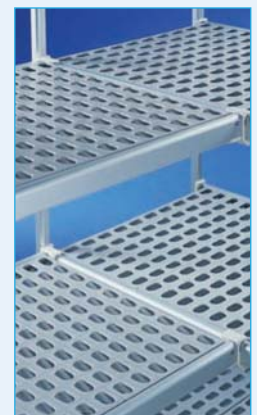

Unobstructed corners

HYGIENIC SHELVING SYSTEMS - STAINLESS STEEL

Stainless steel wire

- Stainless Grade 304 - 6mm and 4mm wire shelves.
- Shelves open-deck design allows air and light penetration.
- Stainless poles grooved @ 25mm increments.
- Unit c/w adjustable feet as standard.
- Load capacity 300kg per shelf.
- Electro-polished finish.
- Usages - Laboratory
Sterile services
Equipment stores
Theatre stores
Decontamination / Autoclave units
Freezer / coldroom areas

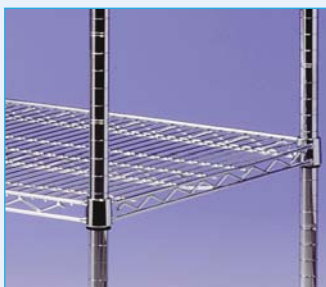

Complete 3 tier units - 1650mm high

	300mm	400mm	500mm	600mm
600	£292	£319	£361	£389
800	£306	£361	£403	£417
900	£311	£375	£417	£431
1000	£319	£383	£431	£458
1200	£361	£403	£444	£486
1500	£403	£472	£514	£583
1800	£431	£519	£556	£653

Complete 4 tier units - 1800mm high

	300mm	400mm	500mm	600mm
600	£361	£403	£458	£500
800	£389	£472	£514	£528
900	£403	£486	£528	£556
1000	£417	£500	£556	£583
1200	£472	£528	£583	£639
1500	£528	£611	£667	£764
1800	£569	£639	£722	£833

Mobile option	£
125mm castors - all swivel / 2x braked	£83
100mm castors - all swivel / 2x braked	£67
125mm castors - stainless steel	£194

Single shelves

	300mm	400mm	500mm	600mm
600	£361	£403	£458	£500
800	£389	£472	£514	£528
900	£403	£486	£528	£556
1000	£417	£500	£556	£583
1200	£472	£528	£583	£639
1500	£528	£611	£667	£764
1800	£569	£639	£722	£833

Stainless steel perforated

- Stainless Grade 304 1.5mm thickness plate shelves.
- Shelves perforated and "dished" for easy clean surfaces.
- Polymer corners eliminating all welds / crevices.
- Stainless poles grooved @ 25mm increments.
- Unit c/w adjustable feet as standard.
- Load capacity 300kg per shelf.
- Usages - Sterile Pack Stores
Sterile services
Equipment stores
TSSU
Decontamination / Autoclave units
Freezer / coldroom areas

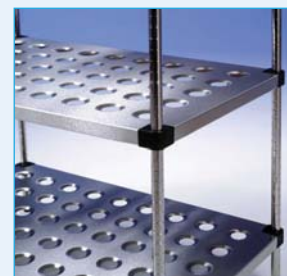

Complete 3 tier units - 1650mm high

	300mm	400mm	500mm	600mm
600	£359	£383	£444	£461
800	£375	£403	£472	£486
900	£397	£444	£556	£514
1000	£417	£514	£611	£597
1200	£500	£583	£644	£639
1500	£528	£625	£681	£667
1800	£583	£639	£708	£722

Complete 4 tier units - 1800mm high

	300mm	400mm	500mm	600mm
600	£417	£500	£528	£556
800	£486	£528	£569	£625
900	£514	£583	£611	£667
1000	£542	£653	£722	£778
1200	£639	£750	£778	£833
1500	£694	£806	£833	£889
1800	£764	£833	£889	£944

Mobile option	£
125mm castors - all swivel / 2x braked	£83
100mm castors - all swivel / 2x braked	£67
125mm castors - stainless steel	£194

Single shelves

	300mm	400mm	500mm	600mm
600	£97	£117	£119	£125
800	£111	£125	£131	£139
900	£117	£139	£147	£153
1000	£125	£150	£167	£181
1200	£153	£167	£181	£194
1500	£167	£181	£194	£208
1800	£181	£194	£208	£222

Accessories

Poles

	Chrome	St/St
300	£8	£13
600	£9	£16
900	£11	£19
1200	£13	£27
1650	£15	£32
1800	£16	£33
2000	£20	£37

3-Sided stability frames - stainless steel

	300mm	400mm	500mm	600mm
600	£42	£46	£53	£56
800	£50	£53	£56	£58
900	£53	£58	£61	£64
1000	£56	£61	£67	£69
1200	£64	£69	£72	£78
1500	£73	£78	£81	£83
1800	£78	£83	£86	£89

Description	£
Shelf Hooks - nylon	£6
Post Clamps - chrome	£7
Post Clamps - St/St	£11
Label Holders	£3
Wall fixings	£28

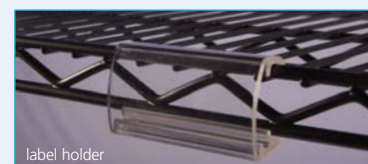

HYGIENIC SHELVING SYSTEMS - SOLID FORMAT

MEDICAL SHELVING

Stainless steel solid

- Stainless grade 304 - 1.5mm thickness plate steel.
- One-piece solid format shelves.
- Polymer corners eliminating welds / crevices.
- Stainless uprights grooved @ 25mm increments.
- Load capacity 300kg per shelf.
- Usages - Sterile pack stores
Sterile services
Equipment stores
Decontamination units
TSSU
Freezer / coldroom environments.



Complete 3 tier units - 1650mm high

	300mm	400mm	500mm	600mm
600	£359	£383	£444	£461
800	£375	£403	£472	£486
900	£397	£444	£556	£514
1000	£417	£514	£611	£597
1200	£500	£583	£644	£639
1500	£528	£625	£681	£667
1800	£583	£639	£708	£722

Complete 4 tier units - 1800mm high

	300mm	400mm	500mm	600mm
600	£417	£500	£528	£556
800	£486	£528	£569	£625
900	£514	£583	£611	£667
1000	£542	£653	£722	£778
1200	£639	£750	£778	£833
1500	£694	£806	£833	£889
1800	£764	£833	£889	£944

Mobile option	£
125mm castors - all swivel / 2x braked	£83
100mm castors - all swivel / 2x braked	£67
125mm castors - stainless steel	£194

Single shelves

	300mm	400mm	500mm	600mm
600	£97	£117	£119	£125
800	£111	£125	£131	£139
900	£117	£139	£147	£153
1000	£125	£150	£167	£181
1200	£153	£167	£181	£194
1500	£167	£181	£194	£208
1800	£181	£194	£208	£222

Powder coated solid

- Powder coated (white as standard) steel - 1.5mm thickness plate steel.
- One-piece solid format shelves.
- Polymer corners eliminating welds / crevices.
- Chrome uprights grooved @ 25mm increments.
- Load capacity 300kg per shelf.
- Usages- General stores
Bulk stores
Linen / Laundry
Utilities
Ward stores
Kitchen drystores



Complete 3 tier units - 1650mm high

	300mm	400mm	500mm	600mm
600	£172	£181	£222	£250
800	£189	£222	£292	£314
900	£208	£250	£306	£328
1000	£236	£278	£319	£347
1200	£278	£306	£333	£369
1500	£306	£361	£389	£403
1800	£347	£403	£417	£428

Complete 4 tier units - 1800mm high

	300mm	400mm	500mm	600mm
600	£208	£222	£278	£319
800	£236	£292	£361	£389
900	£264	£306	£389	£417
1000	£278	£333	£403	£444
1200	£333	£375	£417	£472
1500	£375	£458	£486	£514
1800	£444	£514	£542	£556

Mobile option	£
125mm castors - all swivel / 2x braked	£83
100mm castors - all swivel / 2x braked	£67
125mm castors - stainless steel	£194

Single shelves

	300mm	400mm	500mm	600mm
600	£44	£50	£61	£67
800	£50	£61	£69	£75
900	£56	£67	£83	£89
1000	£64	£75	£92	£97
1200	£75	£89	£97	£103
1500	£83	£97	£106	£111
1800	£97	£111	£125	£128

Accessories

Poles

	Chrome	St/St
300	£8	£13
600	£9	£16
900	£11	£19
1200	£13	£27
1650	£15	£32
1800	£16	£33
2000	£20	£37

3-Sided stability frames - stainless steel

	300mm	400mm	500mm	600mm
600	£42	£46	£53	£56
800	£50	£53	£56	£58
900	£53	£58	£61	£64
1000	£56	£61	£67	£69
1200	£64	£69	£72	£78
1500	£73	£78	£81	£83
1800	£78	£83	£86	£89

Description	£
Shelf Hooks - nylon	£6
Post Clamps - chrome	£7
Post Clamps - St/St	£11
Label Holders	£3
Wall fixings	£28

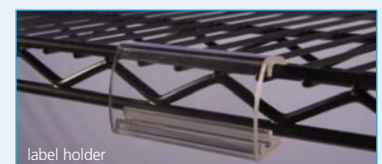

POLYRAKK SHELVING SYSTEM / HIGH DENSITY SYSTEMS

Polyrakk - heavy duty removable mat



- Removable polymer mats - louvred format.
- Nylon coated wire shelf subframe for strength.
- Bright chrome posts - grooved to accept plastic assembly collars.
- Load capacity 400kg per shelf.
- Usage :- Equipment / Ward stores
Theatre stores
General stores
Laboratory
Coldroom / Freezer / Humid environments

Complete 3 tier units - 1650mm high

	300	400	500	600
600	N/A	£195	£219	£240
800	N/A	£212	£240	£264
900	N/A	£237	£269	£288
1000	N/A	£262	£290	£311
1200	N/A	£290	£315	£340
1500	N/A	£320	£342	£371
1800	N/A	£351	£380	£400

Complete 4 tier units - 1800mm high

	300	400	500	600
600	N/A	£280	£290	£302
800	N/A	£295	£315	£330
900	N/A	£318	£336	£358
1000	N/A	£337	£370	£380
1200	N/A	£355	£395	£417
1500	N/A	£386	£424	£466
1800	N/A	£420	£442	£482

Mobile option	£
125mm castors - all swivel / 2x braked	£83
100mm castors - all swivel / 2x braked	£67

Single shelves

	300	400	500	600
600	N/A	£44	£50	£58
800	N/A	£50	£57	£65
900	N/A	£55	£63	£71
1000	N/A	£62	£74	£82
1200	N/A	£74	£84	£95
1500	N/A	£83	£94	£104
1800	N/A	£92	£103	£113

METRO Metro Top Track system



- Top track system using aluminium extruded track positioned at high level.
- Track positioned @ 2185mm FFL and connected to stationary end units.
- Mobile units traverse along track to create an access aisle where required.
- System condenses and maximises space in cramped situations.
- Promotes stock rotation and stock identification / segregation.
- Floor surfaces are easily cleaned.
- All shelving systems (except aluminium/polymer) can be incorporated into this system.
- Minimum height required = 2250mm.
- Maximum loading per mobile unit = 400kg.
- Stationary intermediate units required when track exceeds 6400mm length.
- Fully bespoke design - **Price on application.**

METRO Metro Quik Track system



- Quiktrak system using aluminium extruded or stainless floor laid track.
- Track surface mounted, front and back and connected to stationary end units.
- Mobile units traverse along track to create an access aisle where required.
- Ideal in situations where ceilings are low and Top track cannot be used.
- All shelving systems (except aluminium/polymer) can be incorporated into this system.
- Maximum load for mobile units = 900kg.
- Mobile unit height must not exceed 1880mm.
- Fully bespoke design - **Price on application.**

Chassis mounted high density system

- Stainless steel chassis driven by movement of a hand wheel situated at the front of each unit.
- Chassis traverse along a stainless track positioned at far rear of unit.
- Track floor mounted and positioned so that it is not a trip hazard or dirt trap.
- All gears / bearings and chains enclosed with no finger traps.
- Any shelving system can be mounted on the chassis.
- Also suitable for HTM 71 cabinets to be mounted (see HTM -71 section).
- Chassis load capacity 400kg.
- Maximum chassis length 3000mm.
- Double or single bank units available. **All prices on application.**



High density suspended system

- Anodised aluminium extruded main frame and track.
- Unit can either be freestanding or wall fixed design.
- Aluminium / polymer shelving units suspended from the track. Suitable for all depths.
- Promotes easy to clean / unobstructed floor surfaces.
- Eliminates trip hazards.
- Custom build design to suit available space.
- Intermediate main frame down posts required when unit exceeds 3000mm expanse.
- **All prices on application.**



SECURITY CAGES / EXCHANGE CARTS / DUNNAGE RACKS

MEDICAL
SHELVING

Security cages

- Nylon coated wire or stainless steel options.
- Open grid wire enclosure panels - promotes air circulation and light penetration.
- Lockable hinged doors that can swing through 270 degrees. (lock not incl)
- Fixed top and bottom shelves - top shelf fitted with anti-tamper locking bolts.
- All units fitted with further 2x intermediate wire shelves. Further shelves optional.
- Optional solid base shelf and mobile option.



SC-ST-02 fitted with mobile option

Code	Dimensions	Finish	Internal shelves	£
SC-N-01	900x600x1800mm high	Nylon wire	3	£1,111
SC-N-02	1200x600x1800mm high	Nylon wire	3	£1,319
SC-N-03	1500x600x1800mm high	Nylon wire	3	£1,375
SC-ST-01	900x600x1800mm high	Stainless	3	£1,836
SC-ST-02	1200x600x1800mm high	Stainless	3	£1,947
SC-ST-03	1500x600x1800mm high	Stainless	3	£1,998

Options	£
SC-N-ES Extra shelf - nylon wire	£60
SC-ST-ES Extra shelf - st/st	£170
SC-SOLID Solid stainless base shelf	£195
SC-MOB Mobile option - 125mm castors	£83

Exchange carts



EXC-A-02



EXC-B-03

- Choice of 2x design options - 3 sizes available in each option.
- EXC-A models c/w 3x chrome wire shelves and a stainless solid base shelf.
- EXC-A models also c/w 4x shelf dividers 1x tote box runners and enclosure panels + 6x label holders.
- EXC-B models c/w 4x chrome wire shelves and 3x sets of tote box runners + 12x label holders.
- Tote boxes and extra label holders sold separately.

Code	Dimensions	Finish	Internal shelves	£
EXC-A-01	900x600x1800mm high	Chrome / St	3	£1,490
EXC-A-02	1200x600x1800mm high	Chrome / St	3	£1,610
EXC-A-03	1500x600x1800mm high	Chrome / St	3	£1,745
EXC-B-01	900x600x1800mm high	Chrome	3	£935
EXC-B-02	1200x600x1800mm high	Chrome	3	£1,040
EXC-B-03	1500x600x1800mm high	Chrome	3	£1,175

Options	£
SA-PTB-03 150mm deep plastic tote box (see page 22)	£50
SA-PTB-04 200mm deep plastic tote box (see page 22)	£56
EXC-LABEL Label holders	£3

METRO Polymer dunnage racks

- One piece polymer design.
- Corrosion resistant construction.
- Slotted top for air circulation.
- Easy to clean smooth, radiused surfaces.



MBT-2

Polymer dunnage

Code	Dimensions	Load	£
MBT-1	762x559x305mm high	680kg	£270
MBT-2	914x559x305mm high	680kg	£290
MBT-3	1219x559x305mm high	1365kg	£311
MBT-4	1524x559x305mm high	1365kg	£356

Polymer dunnage - with microban

Code	Dimensions	Load	£
MBT-1-MB	762x559x305mm high	680kg	£315
MBT-2-MB	914x559x305mm high	680kg	£325
MBT-3-MB	1219x559x305mm high	1365kg	£356
MBT-4-MB	1524x559x305mm high	1365kg	£397

Heavy duty stainless dunnage platforms

- Stainless construction throughout - fully fabricated unit.
- Manufactured from 40x40 box section.
- Suitable for all environments.



HDDR-S-2

Code	Dimensions	Load	£
HDDR-S-1	1000x450x400mm high	1360kg	£570
HDDR-S-2	1200x450x400mm high	1360kg	£600
HDDR-S-3	1000x600x400mm high	1087kg	£640
HDDR-S-4	1200x600x400mm high	1087kg	£675

Options	£
HDDR-S-TOP Solid stainless top (removable)	£110

Dunnage racks - chrome / nylon / stainless



- Flat packed design - self assembly.
- Stainless, nylon and chrome coated options.
- Stainless option c/w either solid or perforated shelf.
- Nylon coated + chrome option c/w wire shelf.
- All units c/w 3 sided stability frame for extra rigidity.

Code	Dimensions	Load	Finish	£
DR-C-01	1000x400x400mm high	200kg	Chrome wire	£190
DR-C-02	1200x400x400mm high	200kg	Chrome wire	£210
DR-C-03	1000x600x400mm high	150kg	Chrome wire	£210
DR-C-04	1200x600x400mm high	150kg	Chrome wire	£240
DR-N-01	1000x400x400mm high	200kg	Nylon wire	£190
DR-N-02	1200x400x400mm high	200kg	Nylon wire	£210
DR-N-03	1000x600x400mm high	150kg	Nylon wire	£210
DR-N-04	1200x600x400mm high	150kg	Nylon wire	£240
DR-S-01	1000x400x400mm high	250kg	Stainless	£310
DR-S-02	1200x400x400mm high	250kg	Stainless	£330
DR-S-03	1000x600x400mm high	200kg	Stainless	£330
DR-S-04	1200x600x400mm high	200kg	Stainless	£345

Options	£
DR-MOB Mobile option - 125mm castors	£83

Theatre instrument trolleys



IT-1 complete with buffer option

Code	Dimensions	Tiers	£
IT-1	450x450x870mm high	2	£380
IT-2	600x450x870mm high	2	£425
IT-3	750x450x870mm high	2	£466
IT-4	900x450x870mm high	2	£505

- Stainless steel grade 304 construction.
- Fully fabricated unit. All welds blended for a hygienic, clinical finish.
- Downturned edges to all sides on both shelves.
- Shelf heights set @ 450mm and 870mm high.
- 25mm diameter legs with 75mm castors fitted as standard.
- Fully bespoke service available.

Options		£
IT-LD350	350mm lockable drawer	£173
IT-LD600	600mm lockable drawer (only suitable for IT-3+4 models)	£200
IT-ASC	Anti-static castors 75mm (in lieu of standard castors)	£34
IT-EU-1	Extra undershelf to IT-1+2 models	£66
IT-EU-2	Extra undershelf to IT-3+4 models	£72
IT-RR	Retaining rails to 3 sides (per shelf)	£90
IT-BUF	Set of rubber buffers to castors	£21

Theatre dressing trolleys



DT-3

Code	Dimensions	Tiers	£
DT-1	450x450x870mm high	2	£380
DT-2	600x450x870mm high	2	£425
DT-3	750x450x870mm high	2	£466
DT-4	900x450x870mm high	2	£505

- Stainless steel grade 304 construction.
- Fully fabricated unit. All welds blended for a hygienic, clinical finish.
- Shelf heights set @ 450mm and 870mm high.
- Uprturned edges to sides and rear of top shelf only.
- 25mm diameter legs with 75mm castors fitted as standard .
- Fully bespoke service available.

Options		£
DT-LD350	350mm lockable drawer	£173
DT-LD600	600mm lockable drawer (DT-3 + DT-4 only)	£200
DT-ASC	Anti-static castors 75mm (in lieu of standard castors)	£34
DT-EU-1	Extra undershelf to IT-1+2 models	£66
DT-EU-2	Extra undershelf to IT-3+4 models	£72
DT-BUF	Set of rubber buffers to castors	£21

Theatre instrument / Mayo tables



TIT-2



TIT-4

Code	Dimensions	Wheels	£
TIT-2	430x600x900mm high	2+ skids	£385
TIT-4	430x600x900mm high	4	£415

- Stainless steel, formed, tubular construction.
- Cantilever design.
- Variable height stand - 900mm to 1300mm high max.
- Unit complete with removable stainless instrument tray.
- Tray sits on anti-static buffers to eliminate static and vibration.
- Tray size 530x325mm

Options		£
TIT-2-ASC	Anti-static castors (in lieu of standard castors)	£17
TIT-4-ASC	Anti-static castors (in lieu of standard castors)	£34
TA-TMAY-01	Instrument tray 530x325mm / 20mm dished	£66

IV / Drip / Transfusion Poles



IV-A-04



Quad hook



Anti static castor

- Stainless steel poles and hooks.
- Base options of cast aluminium / polymer or stainless steel.
- 25mm diameter pole with 12mm solid rod "hook"
- Double or quad design "hooks".
- Plastic moulded adjustment collar.
- Height adjustable from 1270mm - 2000mm high.

Code	Dimensions	Hook	£
IV-P-02	650x650x1270-2000mm high	Double	£210
IV-P-04	650x650x1270-2000mm high	Quad	£224
IV-A-02	650x650x1270-2000mm high	Double	£215
IV-A-04	650x650x1270-2000mm high	Quad	£230
IV-ST-02	650x650x1270-2000mm high	Double	£295
IV-ST-04	650x650x1270-2000mm high	Quad	£325

Options		£
IV-ASC	Anti-static castors (in lieu of standard castors)	£34

Theatre bowl stands-fixed height



Code	Dimensions	Bowls	£
TBS-SNGL	400x400x850mm high	1	£266
TBS-SBS	735x400x850mm high	2	£346
TBS-DBT	400x400x850mm high	2	£293

- Stainless steel formed tubular frame - 25mm diameter.
- One piece bowl ring fitted with anti-static buffers to eliminate vibration.
- 75mm castors fitted as standard.
- Stainless bowl sold separately. (see page 10)

Options	£
TBS-ASC 75mm anti-static castors (in lieu of standard castors)	£34
TBS-SB-1 Solid stainless base fitted to TBS-SNGL unit	£55
TBS-SB-2 Solid stainless base fitted to TBS-SBS unit	£90

Theatre bowl stands - adjustable height



Code	Dimensions	Bowls	£
TBS-ADJ-P1	650x650x750-1100mm high	1	£253
TBS-ADJ-P2	650x650x750-1100mm high	2	£306
TBS-ADJ-A1	650x650x750-1100mm high	1	£258
TBS-ADJ-A2	650x650x750-1100mm high	2	£311
TBS-ADJ-S1	650x650x750-1100mm high	1	£333
TBS-ADJ-S2	650x650x750-1100mm high	2	£373

- Stainless steel formed tubular frame with 3x base options.
- One piece bowl ring fitted with anti-static buffers to eliminate vibration.
- Variable height unit 750-1100mm high max.
- 75mm castors fitted as standard.
- Stainless bowl sold separately. (see page 10)

Options	£
TBS-ASC 75mm anti-static castors (in lieu of standard castors)	£34
TBS-BW Base weight - suitable for all models	£59

Theatre bowl stand - low level "kick"



Code	Dimensions	Handle	£
TBS-LLK	345mm dia top ring x 245mm high	No	£165
TBS-LLK-H	345mm dia top ring x 245mm high	Yes	£220

- Stainless steel tubular formed frame.
- One piece bowl ring fitted with anti-static buffers to eliminate vibration.
- 75mm castors fitted as standard.
- Stainless bowl sold separately. (see page 10)

Options	£
TBS-ASC Anti-static castors 75mm (in lieu of standard)	£34
TBS-LLK-BUF Castor rubber buffers	£21

Theatre bucket stand - low level "kick"



Code	Dimensions	Handle	£
TBU-LLK	420x420x540mm high	No	£165
TBU-LLK-H	420x420x540mm high	Yes	£220

- Stainless steel formed tubular frame.
- One piece bucket ring fitted with anti-static buffers to eliminate vibration.
- 75mm castors fitted as standard.
- Stainless bucket sold separately. (see page 10)

Options	£
TBU-ASC Anti-static castors 75mm (in lieu of standard)	£34

Theatre bucket stand - full height

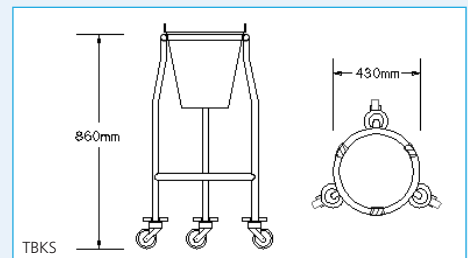

Code	Dimensions	Handle	£
TBKS	420x420x870mm high	No	£266

- Stainless steel formed tubular frame.
- One piece bucket ring fitted with anti-static buffers to eliminate vibration.
- 75mm castors fitted as standard.
- Stainless bucket sold separately. (see page 10)

Options	£
TBU-ASC Anti-static castors 75mm (in lieu of standard)	£34
TBU-S-SS Solid stainless base shelf - removable	£55

Stainless steel 2 tier trolley



TGP-S-2T-8X5

Code	Dimensions	Tiers	Pitch	£
TGP-S-2T-8X5	800x500x960mm high	2	590mm	£426
TGP-S-2T-9X5	900x550x960mm high	2	590mm	£450
TGP-S-2T-10X6	1075x660x960mm high	2	590mm	£556

- Stainless steel construction throughout - fully fabricated unit.
- Dished, one-piece shelves. – sounddeadened.
- Formed tubular, push / pull handles at either end.
- 125mm castors fitted as standard (2x braked)
- Low level "under counter unit" model available (850mm high)- please stipulate at time of order

Options	£
TGP-S-2TRW Retaining wires fitted to 3 sides of shelf (per shelf)	£90
TGP-S-WB Waste bin holder	£181



TGP-S-RW

Retaining wires



TGP-S-WB

waste bin holder

Stainless steel 3 tier trolley



TGP-S-3T-9X5

Code	Dimensions	Tiers	Pitch	£
TGP-S-3T-8X5	800x500x960mm high	3	280mm	£490
TGP-S-3T-9X5	900x550x960mm high	3	280mm	£530
TGP-S-3T-10X6	1075x660x960mm high	3	280mm	£667

- Stainless steel construction throughout - fully fabricated unit.
- Dished, one-piece shelves. – sounddeadened.
- Formed tubular, push / pull handles at either end.
- 125mm castors fitted as standard (2x braked)
- Low level "under counter unit" model available (850mm high)- please stipulate at time of order

Options	£
TGP-S-2TRW Retaining wires fitted to 3 sides of shelf (per shelf)	£90
TGP-S-WB Waste bin holder	£181

METRO Metro Polymer 2 + 3 tier trolley



TGP-P-2T-8X5



TGP-P-3T-8X5

Code	Dimensions	Tiers	Pitch	£
TGP-P-2T-7X4	710x457x845mm high	2	590mm	£293
TGP-P-2T-8X5M	857x546x845mm high *	2	590mm	£333
TGP-P-2T-8X5	857x546x845mm high	2	590mm	£306
TGP-P-2T-10X6	1003x686x845mm high	2	590mm	£360
TGP-P-3T-7X4	710x457x845mm high	3	250mm	£328
TGP-P-3T-8X5M	857x546x845mm high *	3	250mm	£413
TGP-P-3T-8X5	857x546x845mm high	3	250mm	£373
TGP-P-3T-10X6	1003x686x845mm high	3	250mm	£434

- One piece polymer ledged shelves
- 100mm castors fitted as standard (2x braked)
- Plat packed unit - option to be delivered pre-assembled
- Grey or blue colourways
- Sizes suffixed with "M" and marked with asterisk include Microban

Options	£
TGP-P-WB Waste bin	£92
TGP-P-UB Utility bin	£77



TGP-P-WB

TGP-P-WB / UB

Chrome 2 & 3 tier wire trolley

- Chrome wire shelves
- Flat packed self assembly unit or comes pre-assembled
- Tubular handle
- 125mm castors fitted with buffers as standard.



TGP-C-3T-8X5

Code	Dimensions	Tiers	Pitch	£
TGP-C-2T-8X5	800x500x950mm high	2	590mm	£210
TGP-C-2T-9X5	900x500x950mm high	2	590mm	£221
TGP-C-2T-10X5	1000x500x950mm high	2	590mm	£240
TGP-C-3T-8X5	800x500x950mm high	3	250mm	£258
TGP-C-3T-9X5	900x500x950mm high	3	250mm	£267
TGP-C-3T-10X5	1000x500x950mm high	3	250mm	£278

Options	£
TGP-C-WB Waste bin holder	£181

THEATRE SUPPLY TROLLEYS / THEATRE TROLLEY ACCESSORIES

MEDICAL
TROLLEYS

Theatre supply – Bulk storage basket trolleys



Code	Dimensions	Basket capacity	Pitch	£
TST-S-01	630x520x1220mm high	3	325mm	£970
TST-S-02	630x520x1520mm high	4	325mm	£1,165
TST-D-03	630x840x1220mm high	6	325mm	£1,581
TST-D-04	630x840x1520mm high	8	325mm	£1,944

- Stainless steel frame - fully fabricated construction.
- Single sided or back to back units.
- 2x height options available.
- Stainless hooks welded to frame @ 325mm pitch from which baskets hang.
- Units c/w stainless bulk storage wire baskets 600x300x300mm high
- Baskets easily removable for re-stocking / cleaning.
- 125mm anti-static castors fitted as standard.
- 125mm Autoclave castor option.

Options	£
TST-AUTCL Autoclave castors (in lieu of standard castors)	£90

Theatre supply – Bulk storage basket + HTM-71 trolleys



Code	Dimensions mm high	HTM tray capacity (100mm deep)	Basket capacity	£
TST-HTM-09	630x1170x1400 h	10 full size or 20 half size	6	£1,745
TST-HTM-10	630x1170x1800 h	14 full size or 28 half size	8	£2,104

- Stainless steel frame - fully fabricated construction.
- Unit designed to accept bulk storage baskets either side and HTM-71 trays in centre column.
- 2x height options available.
- Stainless hooks welded to frame from which baskets hang @ 325mm pitch.
- Centre column having trayslides @ 120mm pitch for full or half size HTM-71 trays - 100mm deep.
- Unit c/w 6 or 8x stainless steel bulk storage wire baskets 600x300x300mm high.
- HTM-71 trays sold separately.
- 125mm Autoclave castor option.

Options	£
TST-AUTCL Autoclave castors (in lieu of standard castors)	£90

Utility basket trolleys



- Stainless steel frame - fully fabricated construction.
- Single sided or back to back units.
- 2x height options available.
- Stainless hooks welded to frame @ 200mm pitch from which baskets hang.
- Units c/w stainless utility wire baskets 600x300x150mm high.
- Baskets easily removable for re-stocking / cleaning.
- 125mm anti-static castors fitted as standard.
- 125mm Autoclave castor option.

Code	Dimensions	Basket capacity	Pitch	£
TST-S-05	630x520x1220mm high	5	200mm	£1,186
TST-S-06	630x520x1520mm high	6	200mm	£1,338
TST-D-07	630x840x1220mm high	10	200mm	£1,986
TST-D-08	630x840x1520mm high	12	200mm	£2,277

Options	£
TST-AUTCL Autoclave castors (in lieu of standard castors)	£90

Clog rack trolleys



Code	Dimensions mm high	Clog Racks + Baskets / capacity	Pitch	£
TST-S-11	630x520x1520 h	5 / 30prs	200mm	£1,120
TST-S-12	630x520x1520 h	4 + 1 base basket / 24prs	200mm	£1,288
TST-D-13	630x840x1520 h	8 + 2 base basket / 48prs	200mm	£1,954
TST-D-14	630x840x1520 h	10 / 60prs	200mm	£1,906

- Stainless steel frame - fully fabricated construction.
- Single sided or back to back units.
- Stainless hooks welded to frame @ 200mm pitch from which clog racks hang.
- Units c/w stainless clog rack storage units 600x305x200mm high and stainless bulk base baskets where indicated.
- Clog racks and baskets easily removable for cleaning.
- 125mm anti-static castors fitted as standard.

Stainless lotion bowls

- Stainless one-piece, seamless design.
- TA-BOWL-02 suits kick and bowl stands.



Options	Dimensions / Capacity	£
TA-BOWL-01	310mm dia x 130mm high	£31.00
TA-BOWL-02	325mm dia x 140mm high	£35.00
TA-BOWL-03	350mm dia x 150mm high	£43.00

Stainless buckets

- Stainless one-piece, seamless design.
- Graduated on internal surface.
- Integral handle.



Options	Dimensions / Capacity	£
TA-BUC-01	325 dia x 315mm high	£85.00

Stainless instrument trays

- Stainless one-piece, dished design.
- Tray suits Instrument trolleys.



Options	Dimensions	£
TA-TRAY-01	530x325x20mm deep	£66.00

Theatre operating platforms



Code	Dimensions	£
TOP-1	400x300x150mm high	£185
TOP-2	400x300x200mm high	£190
TOP-3	600x300x150mm high	£220
TOP-4	600x300x200mm high	£225

- Grade 304 stainless steel - fully fabricated rigid units.
- Heavy duty, embossed anti-slip top surface.
- 30x30 box section legs fitted with non-slip rubber feet.
- Standard sizes above - bespoke / custom sizes available.

Wash hand basins-knee operated



TWHB-KO

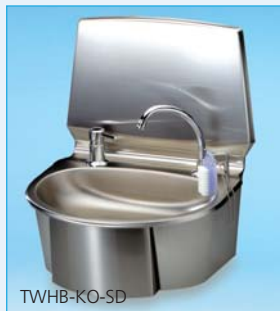

TWHB-KO-SD

Code	Dimensions	Soap dispenser	£
TWHB-KO	900x650x875mm high	No	£885
TWHB-KO-SD	1200x650x875mm high	Yes	£1,053

- Grade 304 stainless steel construction.
- 6 ltr bowl capacity - 100mm deep.
- Hands free controls - leg / knee operated.
- Both wall mounted units.
- Push-down 0.5ltr liquid soap dispenser.
- Splashback fitted to both units.
- Both fitted with integral waste and trap.
- Both fitted with mixer tap.

Shoe cover + apron roll dispensers

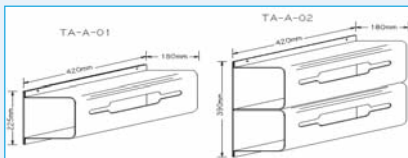

TA-S-01

Code	Dimensions	Description	£
TA-S-01		Shoe cover disp	£121
TA-A-01	420x180x225mm high	Apron disp - single	£70
TA-A-02	420x180x390mm high	Apron disp- double	£104

- Grade 304 stainless steel formed units.
- Shoe dispenser - no need to remove shoes.
- Apron dispenser available in single or double units.
- Apron dispensers - wall mounted - fixings not included.

Options	£
TA-S-REFILL Refill pack for shoe dispenser covers (100 pcs)	£13

Step-over benches



SOB-03

Code	Dimensions	£
SOB-01	1000x400x450mm high	£745
SOB-02	1200x400x450mm high	£805
SOB-03	1500x400x450mm high	£840
SOB-04	1800x400x450mm high	£893
SOB-05	2000x400x450mm high	£946
SOB-06	2500x400x450mm high	£1,054

- Grade 304 stainless steel - fully fabricated units.
- Sounddeadened, heavy duty top with safety edges.
- Rear panel and base made from single piece - promotes easy to clean surfaces.
- Alloy adjustable feet fitted as standard.
- Base shelf for stowage of boots / clogs.
- Standard sizes above - bespoke / custom sizes available.

Wash stations



TWS-01

TWS-02

Code	Dimensions	Description	£
TWS-01	500x375x625mm high	Single wash station	£1,797
TWS-02	1100x375x625mm high	Double wash station	£2,701
TWS-03	1600x375x625mm high	Triple wash station	£3,832

- Stainless steel construction throughout.
- One-piece splashback and housing.
- Stainless faucet with infra-red sensor.
- No-touch design.
- Mains or battery powered. Transformers included. (Connection by others)
- All units wall mounted.
- Soap dispenser on all models.

Gel + glove dispensing holders

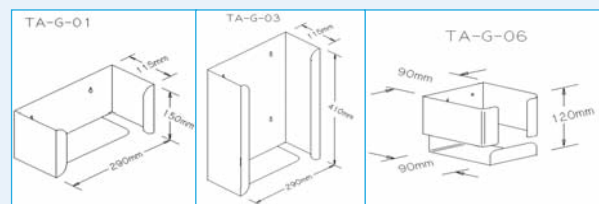

Code	Dimensions	Description	£
TA-G-01	290x115x150mm high	Single glove holder	£45
TA-G-03	290x115x410mm high	Triple glove holder	£69
TA-G-06	90x90x120mm high	Gel dispenser holder	£38

- Grade 304 stainless steel, one-piece, formed units.
- Radiused, snag-free edges
- All units wall mounted - fixings not included.
- Easy dispensing option for a frequently used product.

Catheter procedure trolleys



TCT-32-B



TCT-24-C

Code	Dimensions	Hooks	Bar / length	£
TCT-32-B	1220x610x1750mm high	32	4 @ 1219mm	£2,213
TCT-40-B	1525x610x1750mm high	40	4 @ 1524mm	£2,453
TCT-24-C	1525x610x1750mm high	24	4 @ 914mm	£2,949

- Hygienic chrome plated wire unit - delivered pre-assembled.
- Hooks accommodate pouches from 3" (76mm) to 58" (1473mm).
- All above units c/w 6x plastic bins.
- All units c/w side and back ledges for top and base shelves.
- Model TCT-24-C c/w 2x tote boxes + slides / 3x intermediate 610x610 shelves.
- All units fitted with 4x castors 125mm.

Options	£
TCT-LH Label holders to affix to shelf fronts (bag of 20pcs)	£34
TCT-PPH Push / Pull handles fitted to either end on unit	£93
TCT-CH Extra catheter hooks	£32
TCT-CB-1 Extra catheter bar -914mm	£56
TCT-CB-2 Extra catheter bar -1219mm	£78
TCT-CB-3 Extra catheter bar -1524mm	£93

Suture trolley



TST-6

Code	Dimensions	Shelves	£
TST-1	610x457x1525mm high	1x flat / 4x slanted	£1435
TST-2	610x457x1525mm high	5x slanted	£1296
TST-3	915x457x1525mm high	1x flat / 4x slanted	£1329
TST-4	915x457x1525mm high	5x slanted	£1390
TST-5	1220x457x1525mm high	1x flat / 4x slanted	£1407
TST-6	1220x457x1525mm high	5x slanted	£1468

- Hygienic chrome plated wire unit - delivered pre-assembled.
- 2x model options - all 5 slanted shelves or 4x slanted + 1x flat
- Slanted chrome shelves @ 45 degrees
- Retaining ledges fitted to front and sides
- Aids organisation / eliminates confusion / simplifies product ordering
- All units fitted with 125mm castors

Options	£
TST-PPH Push / Pull handles fitted to either end on unit	£93
TST-LH Label holders to affix to shelf fronts (bag of 20pcs)	£53

Sterile wrap trolley - full height



TSWR-2

- Hygienic chrome plated wire unit - delivered pre-assembled.
- Unit c/w 2x slanted hanging rails + 4x wrap support bars + 1x chrome wire base shelf.
- Wrap support bars easily removable for re-loading and height adjustable to suit wrap sizes.
- Base shelf suitable for storage of less frequently used sizes.
- Units fitted with 125mm castors.

Code	Dimensions	Wrap Bars	£
TSWR-1	1220x610x1730mm high	4	£1,444
TSWR-2	1525x610x1730mm high	4	£1,554

Options	£
TSWR-SB-1 Additional wrap support bars 1220mm	£78
TSWR-SB-2 Additional wrap support bars 1525mm	£92
TSWR-COV-1 White cover to suit TSWR-1 unit	£237
TSWR-COV-2 White cover to suit TSWR-2 unit	£278

Sterile wrap trolley - low level



- Stainless steel, fully fabricated, constructed unit.
- 5x support bars set at 2x heights for large and medium size wraps.
- Snag-free design.
- Wire retaining arms, gravity operated, fitted to all support bars.
- Fitted with 125mm castors - buffers fitted as standard.
- Optional stainless base shelf for extra storage of less frequently used wraps.

Code	Dimensions	Wrap Bars	£
TSWR-LL1	1350x670x1200mm high	5	£1,828

Options	£
TSWR-LL-BS Stainless steel solid format base shelf	£184

Sterile wrap trolley - small wraps



Code	Dimensions	Tiers	£
TSWR-S-1	930x790x1350mm high	4	

- Stainless steel, fully fabricated, constructed unit.
- 4 tiered unit - each tier having side and back ledges.
- Shelf and ledges being one-piece design for snag free surfaces.
- Push / pull handles fitted as standard.
- Fitted with 100mm castors c/w buffers fitted as standard.

Plaster trolley

- Stainless steel construction throughout.
- 2 or 3 drawer model options.
- Formed tubular frame from 30x30 box section.
- Solid, sounddeadened worktop to eliminate vibration.
- Worktop 750x550 @ 925mm FFL.
- Drawers fully enclosed and fitted with telescopic, "smooth-running" runners.
- Choice of "D", recessed or full width handles.
- Units includes integral bucket ring and 15ltr stainless bucket.
- Solid base shelf set @ 150mm FFL.
- 75mm castors fitted as standard.



PT-3D (with lockable drawer option)

Code	Dimensions	Drawers	Bucket	£
PT-2D	1150x550x925mm high	2	15ltr	£2,154
PT-3D	1150x550x925mm high	3	15ltr	£2,294

Options	£
PT-LD Lockable drawer option (per drawer)	£50
PT-EUS Extra undershelf (optional on 2 drawer model only)	£115
PT-EWT Extended worktop (300x550mm hinged extension)	£120
PT-ASC Anti-static castors 75mm (in lieu of standard)	£34
PT-BUF Rubber buffers	£21

Cylinder Trolleys - D+E Compatible

- Fully fabricated stainless or powder coated mild steel options.
- Formed tubular frame with 2 levels of formed plate steel with apertures cut to suit D+E type cylinders.
- Apertures cut @ 110mm diameter. To accept max bottle height 900mm.
- Handle fitted to one end only.
- Non-slip rubberised base fitted to base shelf.
- Heavy duty 125mm castors - 2x braked.



CT-1-MS

Code	Dimensions	Capacity	£
CT-1-ST	480x600x970mm high	12 cylinders	£1,013
CT-1-MS	480x600x970mm high	12 cylinders	£893

Options	£
CT-2PPH Push / Pull handles fitted to both ends on unit	£120
CT-BUF Rubber buffers	£21

Cylinder trolleys - F+G compatible



CT-2



CT-3

Code	Dimensions	Capacity	£
CT-2	550x700x1150mm high	1 cylinder	£890
CT-3	800x750x1150mm high	2 cylinders	£1,285

- Fully fabricated powder coated mild steel tubular construction.
- F+G cylinder compatible.
- Stabilising 100mm castors at rear to avoid toppling over.
- 200mm pneumatic wheels fitted to front to dampen vibration.
- Retaining chains to secure cylinders, fitted on both models.

Medicine trolley



MT-PC1 with optional MT-EWT - extended, hinged worktop

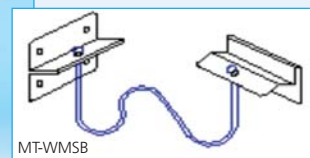

MT-WMSB

Code	Dimensions	£
MT-SS1	600 X 450 X 1115mm high - stainless steel	£1,310
MT-PC1	600 X 450 X 1115mm high - powder coated	£1,160

- Stainless steel or Powder coated steel construction.
- Tubular formed frame with one-piece formed cabinet.
- Fixed height solid base shelf as standard
- Hinged lid cabinet using concealed hinges.
- Cabinet fitted with high Security Lock as standard, supplied with 2 keys.
- Cabinet c/w internal "stepped" insert to aid storage / identification and access to product.
- Integral push / pull handle to one end.
- Fitted with 75mm Castors (all unbraked swivel)
- Powder coated option - white standard colour.

Options	£
MT-WMSB Wall mounted security bracket (Stainless Steel) 500mm long	£88
MT-EWT Extended worktop (300x450mm hinged extension) Stainless Steel	£115
MT-ASC Anti-static castors 75mm (in lieu of standard)	£34
MT-BUF Rubber buffers	£21
MT-EXKEYS Extra keys (pair)	£32

Medical record / Patients notes trolley



Code	Dimensions	£
MRT-PC1	1035x450x900mm high Powder Coated Mild Steel	£1,525
MRT-SS2	1035x450x900mm high Stainless Steel	£1,786

- Fully fabricated powder coated mild steel construction.
- Tubular frame with enclosed, perforated panelled side and base cabinet for record storage.
- Cabinet to have hinged doors allowing access from the top.
- Cabinet fitted with high Security Lock as standard, supplied with 2 keys.
- Cabinet able to accept both Foolscap and A3 File hangers (not inc).
- Cabinet depth of 400mm to accommodate x-rays.
- Unit to have integral handles fitted to both ends.
- Fitted with 75mm Castors (all unbraked swivel).
- Powder coated white - standard colour.
- Other colour options available on request.

Options	£
MRT-SSW Solid side walls (in lieu of perforated)	n/c
MT-EXKEYS Extra keys (pair)	£32
MRT-ASC Anti-static castors 75mm (in lieu of standard)	£34
MRT-BUF Rubber buffers	£21

CARE / PROCEDURE / EMERGENCY CARTS

MEDICAL TROLLEYS

Metro "Basix" Care Carts



- Powder coated aluminium and Polymer construction.
- 3x sized models available.
- Comprehensive range of accessories enables customisation to all models.
- Option of 10x pre-configured carts in each size.

Code	Dimensions	£
MBC (Compact model)	490x470x876mm high	POA
MBL (low level unit)	762x613x978mm high	POA
MBH (high level unit)	762x613x1440mm high	POA

Examples of pre-configured "Basix" carts.



Anesthesia Cart



Isolation Cart



Code Response Cart

Metro "Basix Plus" Care Carts



- Powder coated aluminium and polymer construction.
- 14x colour drawer options.
- 2x heights available - 38 and 44 inch.
- Comprehensive range of accessories to suit all models.
- Option of 9x pre-configured carts in each size. Please ask for more details.

Code	Dimensions	£
MB+L (Low level unit)	610x572x965mm high	POA
MB+H (high level unit)	610x572x1118mm high	POA

Examples of pre-configured "Basix Plus" carts.



Basix Plus Anesthesia Cart



Basix Plus - Trauma Cart



Basix Plus - Endoscopic Cart

METRO "Lifeline" Emergency Carts

- Advanced polymer construction with "microban" anti-bacterial protection.
- 3x heights available.
- Comprehensive range of accessories enables customisation to all models.
- Option of 5x pre-configured response carts + 1x pediatric cart in each size.



ML42 basic cart with drawers

Code	Dimensions	£
ML39	962x587x991mm high	POA
ML42	962x587x1067mm high	POA
ML45	962x587x1143mm high	POA

Examples of pre-configured "Lifeline" carts.



ML39 Response



ML42 Response



ML45 Response

METRO "Flexline" Emergency Carts

- Advanced polymer construction with "microban" anti-bacterial protection.
- 2x widths available, standard (MFS units) and narrow (MFN units)
- 4x heights available - 36 / 39 / 42 and 45 inch.
- 10x colour options of drawer pull
- Comprehensive range of accessories enables customisation to all models.
- Option of 23x pre-configured response carts.

Flexline Code Response (front) and Critical Care Carts



Code	Dimensions	£
MFN-36	735x570x914mm high	POA
MFN-39	735x570x991mm high	POA
MFN-42	735x570x1067mm high	POA
MFN-45	735x570x1143mm high	POA
MFS-36	820x570x914mm high	POA
MFS-39	820x570x991mm high	POA
MFS-42	820x570x1067mm high	POA
MFS-45	820x570x1143mm high	POA

Examples of pre-configured "Flexline" carts.



Anesthesia Cart



Phlebotomy Cart



Surgical Cart

METRO Bulk linen trolley - polymer



Code	Dimensions	Capacity	£
BLT-1	1735x725x1220mm high	48ft/cu	£1,952

- Polymer construction - charcoal grey colour.
- 48 cubic feet volume / 200kg load capacity.
- 6" Heavy duty castors
- Lifetime anti-corrosion guarantee

METRO Convertible linen trolley - polymer



Code	Dimensions	Load capacity	£
CLT-1	1735x725x1220mm high	200kg	£2,720

- Polymer construction - charcoal grey colour.
- Fitted with 2x shelves which can be positioned horizontally or vertically.
- 6" Heavy duty castors.
- Lifetime anti-corrosion guarantee.

Bulk linen trolley - Roll Cages



BLT-RC-1



BLT-RC-2

Code	Dimensions	Door	£
BLT-RC-1	720x810x1890mm high	2x 1/2 doors	£680
BLT-RC-2	720x810x1890mm high	1x full height	£626

- Electro galvanised wire finish.
- 500kg load capacity on both models.
- 100mm castors 2x fixed / 2x swivel
- Hinged doors - no locks included.

Linen Transfer trolley



LTT-2

- Fitted with 4x chrome wire shelves and 1x stainless base shelf.
- Shelf pitch @ 350mm.
- Wire mesh enclosure panels to sides and rear.
- Bumpers fitted to base shelf.
- 125mm castors fitted as standard

Code	Dimensions	Shelves	£
LTT-1	900x600x1500mm high	1x solid / 4x wire	£1,160
LTT-2	1200x600x1500mm high	1x solid / 4x wire	£1,213
LTT-3	1500x600x1500mm high	1x solid / 4x wire	£1,240

Options	£
LTT-ES Extra wire shelf to any of the above models	£55
LTT-PP Push / Pull handles fitted to each end	£95
LTT-TBS Tote box slides to accept tote box storage	£185

Dirty linen "Hamper" trolley



Code	Dimensions	£
DLT-H	830x530x1025mm high	£746

- Stainless fully fabricated construction.
- Hooks attached to handles from which linen bag hung.
- 100mm castors.
- Linen hamper not included.

Options	£
DLT-H-BS Removable base shelf	£77
DLT-BUF Castor buffers	£21
DLT-BAG Linen bag to suit	£35

Soiled linen ward trolleys



LWT-1

- Stainless steel fully fabricated construction.
- Single or double models.
- Solid base to take weight of full waste bag.

Code	Dimensions	Model	£
LWT-1	400x500x975mm high	Single bag	£496
LWT-2	800x500x975mm high	Double bag	£646

Options	£
LWT-BUF Castor buffers	£21

HTM-71 TRAY TROLLEYS

MEDICAL
TROLLEYS

Full size tray trolley-single



HT-PC-01

HT-01

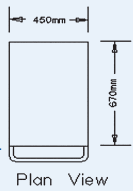
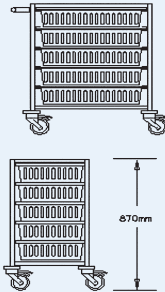

Code	Dimensions	Tiers	£
HT-01-PC	670x450x870mm high	5	£405
HT-01-SS	670x450x870mm high	5	£466

- Designed to store full size HTM-71 trays.
- Trays ordered separately.
- Factory fitted Accessory rail optional.
- Powder coated or stainless steel fully fabricated options.
- 75mm castors + buffers fitted as standard.
- Both options c/w stainless steel removable recessed top.
- 25mm box section frame with 5 pairs of trayslides fitted @ 150mm pitch.
- "Anti-tilt" design trayslides, allows tray to be withdrawn without tipping.
- Watertight recessed top allowing any spillage to be contained.
- Push / pull handle fitted as standard - omitted if required.
- Powder coated white or grey colour options - please stipulate at time of order.

Code	Dimensions	£
HT-01-WS	Stainless wire shelf (removable) to suit trolley	£32
HT-PC-SP-01	Enclosure panels to 3 sides - powder coated	£240
HT-SS-SP-01	Enclosure panels to 3 sides - stainless	£266
HT-PC-HD-01	Enclosure panels + hinged doors - powder coated	£386
HT-SS-HD-01	Enclosure panels + hinged doors - stainless	£430
HT-HD-LOCK	Lockable option	£70

Full size - double width tray trolley

HT-03

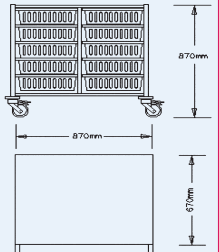
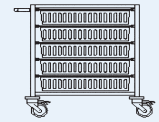

Plan View

- Powder coated or stainless steel fully fabricated options.
- 25mm box section frame with 5 pairs of trayslides fitted @ 150mm pitch.
- "Anti-tilt" design trayslides, allows tray to be withdrawn without tipping.
- Both options c/w stainless steel removable recessed top.
- Watertight recessed top allowing any spillage to be contained.
- Push / pull handle fitted as standard - omitted if required.
- Suitable to store full size HTM-71 trays.
- Trays ordered separately - see separate section.
- Factory fitted Accessory rail optional - see below.
- Powder coated white or grey colour options - please stipulate at time of order.
- 75mm castors + buffers fitted as standard.

Code	Dimensions	Tiers	£
HT-03-PC	1300x450x870mm high	2x5	£520
HT-03-SS	1300x450x870mm high	2x5	£626

Code	Dimensions	£
HT-03-WS	Stainless wire shelf (removable) to suit trolley	£32
HT-PC-SP-03	Enclosure panels to 3 sides - powder coated	£338
HT-SS-SP-03	Enclosure panels to 3 sides - stainless	£386
HT-PC-HD-03	Enclosure panels + hinged doors - powder coated	£460
HT-SS-HD-03	Enclosure panels + hinged doors - stainless	£520
HT-HD-LOCK	Lockable option	£70

Full size - double length tray trolley

HT-02

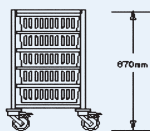

Code	Dimensions	Tiers	£
HT-02-PC	1300x450x870mm high	2x5	£520
HT-02-SS	1300x450x870mm high	2x5	£626

- Powder coated or stainless steel fully fabricated options.
- 25mm box section frame with 5 pairs of trayslides fitted @ 150mm pitch.
- "Anti-tilt" design trayslides, allows tray to be withdrawn without tipping.
- Both options c/w stainless steel removable recessed top.
- Watertight recessed top allowing any spillage to be contained.
- Suitable to store full size HTM-71 trays.
- Trays ordered separately.
- Push / pull handle fitted as standard - omitted if required.
- Factory fitted Accessory rail optional.
- Powder coated white or grey colour options - please stipulate at time of order.
- 75mm castors + buffers fitted as standard.

Code	Dimensions	£
HT-02-WS	Stainless wire shelf (removable) to suit trolley	£32
HT-PC-SP-02	Enclosure panels to 3 sides - powder coated	£338
HT-SS-SP-02	Enclosure panels to 3 sides - stainless	£386
HT-PC-HD-02	Enclosure panels + hinged doors - powder coated	£460
HT-SS-HD-02	Enclosure panels + hinged doors - stainless	£520
HT-HD-LOCK	Lockable option	£70

Half size tray trolley

HT-04

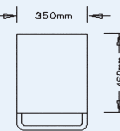
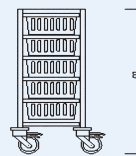
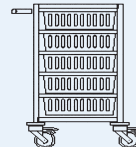

Plan View



Recessed stainless top - as standard on both options.

Code	Dimensions	Tiers	£
HT-04-PC	460x350x870mm high	5	£330
HT-04-SS	460x350x870mm high	5	£383

- Powder coated or stainless steel fully fabricated options.
- 25mm box section frame with 5 pairs of trayslides fitted @ 150mm pitch.
- "Anti-tilt" design trayslides, allows tray to be withdrawn without tipping.
- Both options c/w stainless steel removable recessed top.
- Watertight recessed top allowing any spillage to be contained.
- Push / pull handle fitted as standard - omitted if required.
- Designed to store half size HTM-71 trays.
- Trays ordered separately.
- Factory fitted Accessory rail optional.
- Powder coated white or grey colour options - please stipulate at time of order.
- 75mm castors + buffers fitted as standard.

Code	Dimensions	£
HT-04-WS	Stainless wire shelf (removable) to suit trolley	£32
HT-PC-SP-04	Enclosure panels to 3 sides - powder coated	£185
HT-SS-SP-04	Enclosure panels to 3 sides - stainless	£213
HT-PC-HD-04	Enclosure panels + hinged doors - powder coated	£310
HT-SS-HD-04	Enclosure panels + hinged doors - stainless	£360
HT-HD-LOCK	Lockable option	£70

HTM-71 TRAY TROLLEYS / FULL HEIGHT HTM-71 RACKS

Full size procedure trolley - single

- Suitable to store full size HTM-71 trays.
- Trays ordered separately.
- 75mm castors + buffers fitted as standard.
- Powder coated or stainless steel fully fabricated options.
- 25mm box section frame with 3 pairs of trayslides fitted @ 150mm pitch.
- "Anti-tilt" design trayslides, allows tray to be withdrawn without tipping.
- Both options c/w stainless steel removable recessed top.
- Watertight recessed top allowing any spillage to be contained.
- Unit c/w stainless steel solid intermediate shelf as standard.
- Push / pull handle fitted as standard - omitted if required.
- Factory fitted Accessory rail optional.
- Powder coated white or grey colour options - please stipulate at time of order.

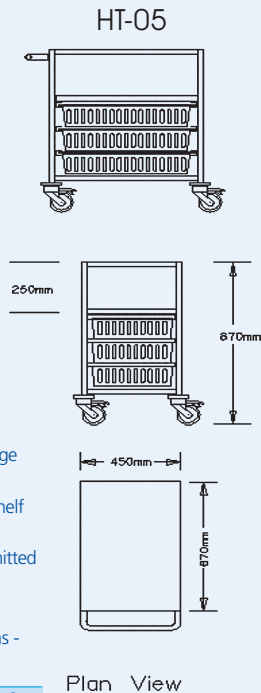

Code	Dimensions mm high	Tiers	£
HT-05-PC	670x450x870	3 tier + shelf	£436
HT-05-SS	670x450x870	3 tier + shelf	£520

Code	Dimensions	£
HT-PC-SP-05	Enclosure panels to 3 sides - powder coated	£240
HT-SS-SP-05	Enclosure panels to 3 sides - stainless	£266
HT-PC-HD-05	Enclosure panels + hinged doors - powder coated	£386
HT-SS-HD-05	Enclosure panels + hinged doors - stainless	£430
HT-HD-LOCK	Lockable option	£70

Full size procedure trolley - double width

- Powder coated or stainless steel fully fabricated options.
- 25mm box section frame with 3 pairs of trayslides fitted @ 150mm pitch.
- "Anti-tilt" design trayslides, allows tray to be withdrawn without tipping.
- Both options c/w stainless steel removable recessed top
- Watertight recessed top allowing any spillage to be contained.
- Unit c/w stainless steel solid intermediate shelf as standard.
- Push / pull handle fitted as standard - omitted if required.
- Suitable to store full size HTM-71 trays.
- Trays ordered separately - see separate section.
- Factory fitted Accessory rail optional - see below.
- Powder coated white or grey colour options - please stipulate at time of order.
- 75mm castors + buffers fitted as standard.

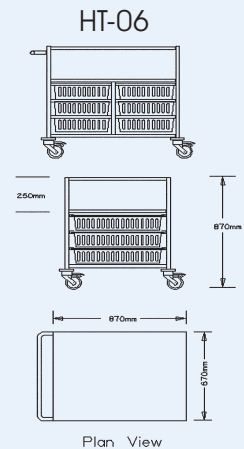

Code	Dimensions	Tiers	£
HT-06-PC	870x670x870mm high	2x3 tier + shelf	£586
HT-06-SS	870x670x870mm high	2x 3tier + shelf	£680

Code	Dimensions	£
HT-PC-SP-06	Enclosure panels to 3 sides - powder coated	£338
HT-SS-SP-06	Enclosure panels to 3 sides - stainless	£386
HT-PC-HD-06	Enclosure panels + hinged doors - powder coated	£460
HT-SS-HD-06	Enclosure panels + hinged doors - stainless	£520
HT-HD-LOCK	Lockable option	£70

HTM-71 Static Frames - single

- Fully fabricated unit.
- Powder coated or stainless steel options.
- 25mm box section frame notched @ 60mm increments to accept trayslides.
- Unit fitted with 8 pairs of "Clip-in" trayslides - allows flexibility on storage permutations.
- "Anti-tilt" design trayslides - allows tray to be withdrawn without tipping.
- Designed to store full size or half size HTM-71 trays - trays sold separately
- Suggested storage permutations:-
 - 6x 200mm deep trays or
 - 12x 100mm deep trays or
 - 4x 200mm + 4x 100mm trays or
 - 5x 200mm + 2x 100mm trays
- Powder coated white or grey colour options - please stipulate at time of order.
- Units can be interlinked for extra rigidity or fixed back to the wall.

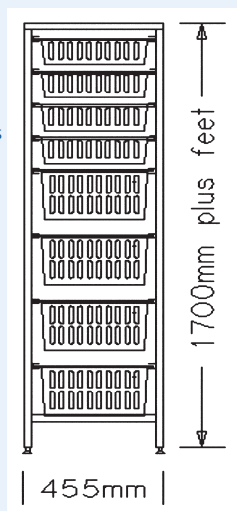

Code	Dimensions	Tiers	£
HT-SSF-01	455x650x1700mm high	Adjustable	£705
HT-PCSF-01	455x650x1700mm high	Adjustable	£595

Code	Dimensions	£
HT-SSF-TS	Extra Stainless trayslides (pair)	£21
HT-PCSF-TS	Extra Powder coated trayslides (pair)	£15
HT-SF-WB	Joining / Wall bracket	£38

HTM-71 Static Frames - double

- Fully fabricated unit.
- Powder coated or stainless steel options.
- 25mm box section frame notched @ 60mm increments to accept trayslides.
- Unit fitted with 16 pairs of "Clip-in" trayslides - allows flexibility on storage permutations.
- "Anti-tilt" design trayslides - allows tray to be withdrawn without tipping.
- Designed to store full size or half size HTM-71 trays - trays sold separately
- Suggested storage permutations:-
 - 12x 200mm deep trays or
 - 24x 100mm deep trays or
 - 8x 200mm + 8x 100mm trays or
 - 10x 200mm + 4x 100mm trays
- Powder coated white or grey colour options - please stipulate at time of order.
- Units can be interlinked for extra rigidity or fixed back to the wall.

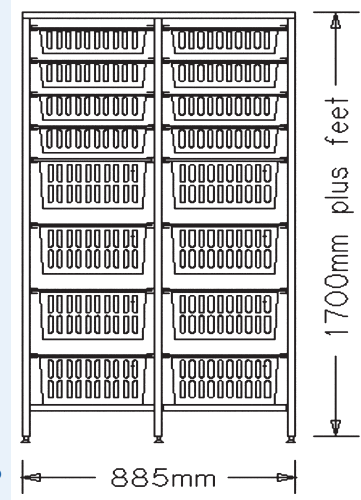

Code	Dimensions	Tiers	£
HT-SSF-02	885x650x1700mm high	Adjustable	£1,025
HT-PCSF-02	885x650x1700mm high	Adjustable	£795

Code	Dimensions	£
HT-SSF-TS	Extra Stainless trayslides (pair)	£21
HT-PCSF-TS	Extra Powder coated trayslides (pair)	£15
HT-SF-WB	Joining / Wall bracket	£38

HTM-71 TROLLEY ACCESSORIES

MEDICAL
TROLLEYS

Stainless Accessory Rail

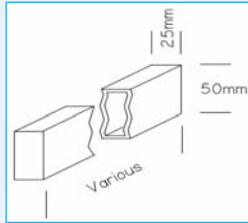

- Stainless steel rails fitted to trolley end.
- Rails have to be ordered at time of trolley order.
- Suitable to be fitted on both stainless and powder coated HTM trolley's.
- Rails allow accessories to hang from.

Code	To suit trolley / s	Rail length	£
HT-AC-R-01	HT-04	300mm	£44
HT-AC-R-02	HT-01/HT-02/HT-05	400mm	£48
HT-AC-R-03	HT-03/HT-06	600mm	£54

Glove + Gel Dispensers

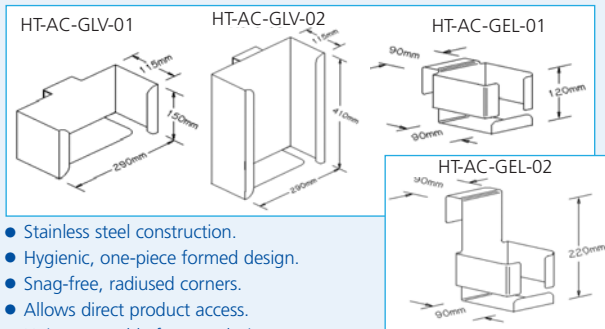

- Stainless steel construction.
- Hygienic, one-piece formed design.
- Snag-free, radiused corners.
- Allows direct product access.
- Units removable for autoclaving.
- "Hook-on" design - to be used with "Accessory rails"

Code	Model	Dimensions	£
HT-AC-GLV-01	Glove - single box	290x115x150mm high	£68
HT-AC-GLV-02	Glove - triple box	290x115x410mm high	£96
HT-AC-GEL-01	Gel - small	90x90x120mm high	£56
HT-AC-GEL-02	Gel - large	90x90x220mm high	£64

Catheter / Scope Holder - Dispenser

HT-AC-C-04

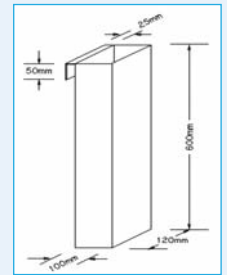

- Stainless steel formed unit - one piece design.
- Welded construction.
- "Hook-on" design - to be used with "Accessory rails"
- Safe transportation - eliminates damage to product
- Allows direct product access.
- Solid format - hygienic, easy to clean surfaces
- Unit removable for autoclaving.

Please note HT-AC-C-03 cannot be used on an HT-AC-R-04 rail.

Code	Code	Dimensions	£
HT-AC-C-01		120x100x400mm high	£168
HT-AC-C-02		240x100x400mm high	£182
HT-AC-C-03		360x100x400mm high	£204
HT-AC-C-04		120x100x600mm high	£198
HT-AC-C-05		240x100x600mm high	£218
HT-AC-C-06		360x100x600mm high	£226

Bucket / Bowl Holders



- Stainless steel construction.
 - One piece ring fully welded to "Hook-on" bracket.
 - Rings fitted with anti-static buffers - eliminates vibration.
 - "Hook-on" design - to be used with "Accessory rails"
 - Units removable for autoclaving.
- Buckets / bowls sold separately - see page 10 of price list.

Code	Model	Dimensions	£
HT-AC-BUC-01	Bucket holder - to suit bucket TA-BUC-01	440x375mm	£104
HT-AC-BOWL-01	Bowl holder - to suit bowl TA-BOWL-02	440x375mm	£104

HTM FITTED CABINETS - Wall Units / Base Units / Full Height Units

Full Height units

- Melamine faced MDF carcass - choice of colours.
- Standard height 2100mm high.
- Injected moulded ABS "tray runner" liners fitted as standard.
- 400 or 600mm entry profile for accepting HTM-71 trays.
- Rigid scope basket option.
- Either freestanding units or incorporated into a scheme.
- Choice of doors / handles / closures / plinths.
- **All prices on application.**



Base Units

- Melamine faced MDF carcass - choice of colours.
- Standard height 875mm high.
- Injected moulded ABS "tray runner" liners fitted as standard.
- 400 or 600mm entry profile for accepting HTM-71 trays.
- Rigid scope basket option.
- Worktop options.
- Choice of doors / handles / closures / plinths. • **All prices on application.**



Wall units

- Melamine faced MDF carcass - choice of colours.
- Standard height 650mm high.
- Injected moulded ABS "tray runner" liners fitted as standard.
- 400 or 600mm entry profile for accepting HTM-71 trays.
- Rigid scope basket option.
- Sloping tops optional.
- Choice of doors / handles / closures.
- **All prices on application.**



HTM- HIGH DENSITY SYSTEM

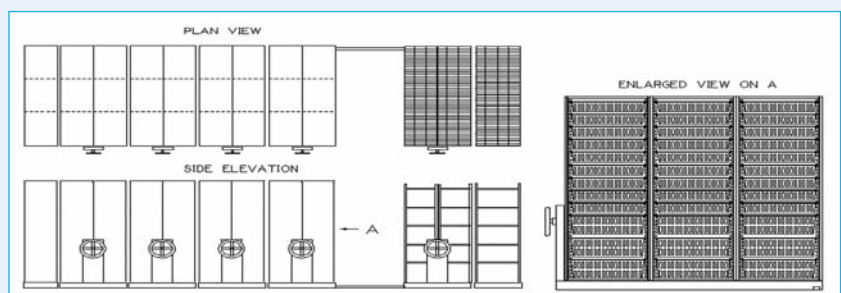

- HTM full height units mounted on a chassis system.
- Chassis traverse along a st/st floor mounted track.
- Units mechanically driven by movement of the hand wheel positioned at the front of each chassis.
- System condenses and maximises available storage space.
- **Price on application.**

PREPARATION / PROCESS TABLES

Stainless Prep / Process Tables



SP-T-04-WB

Code	Dimensions	Undershelf	£
SP-T-01-WB	600x650x875mm high	1	£645
SP-T-02-WB	900x650x875mm high	1	£720
SP-T-03-WB	1000x650x875mm high	1	£790
SP-T-04-WB	1200x650x875mm high	1	£855
SP-T-05-WB	1500x650x875mm high	1	£930
SP-T-06-WB	1800x650x875mm high	1	£1,000

- Grade 304 stainless steel - fully fabricated units.
- Sounddeadened, heavy duty, worktop.
- All units c/w 75mm upstand to rear.
- Undershelf fitted as standard @ 150mm FFL.
- Alloy adjustable feet fitted as standard.
- 750mm deep units also available - please add 10% to above 650mm deep unit cost. ● 40 x 40mm box section legs.

Options	£
SP-EU-1 Extra undershelf to suit SP-T-01/02/03 models	£160
SP-EU-2 Extra undershelf to suit SP-T-04/05/06 models	£210
SP-R Runners (3 prs) under to suit HTM-71 trays	£190
SP-IP Infill panels to sides and rear	£420
SP-CUP Integral cupboard under - c/w lockable hinged doors	£660
SP- MO Mobile option - 125mm castors fitted	£105

Stainless Prep / Process Tables (no upstand)



SP-T-05-CB with option SP-DR

Code	Dimensions	Undershelf	£
SP-T-01-CB	600x650x875mm high	1	£580
SP-T-02-CB	900x650x875mm high	1	£625
SP-T-03-CB	1000x650x875mm high	1	£690
SP-T-04-CB	1200x650x875mm high	1	£720
SP-T-05-CB	1500x650x875mm high	1	£773
SP-T-06-CB	1800x650x875mm high	1	£820

- Grade 304 stainless steel - fully fabricated units.
- Sounddeadened, heavy duty, worktop.
- All units c/w downturns to all sides.
- Undershelf fitted as standard @ 150mm FFL.
- Alloy adjustable feet fitted as standard.
- 750mm deep units also available - please add 10% to above 650mm deep unit cost. ● 40 x 40mm box section legs.

Options	£
SP-EU-1 Extra undershelf to suit SP-T-01/02/03 models	£160
SP-EU-2 Extra undershelf to suit SP-T-04/05/06 models	£210
SP-R Runners (3 prs) under to suit HTM-71 trays	£190
SP-IP Infill panels to sides and rear	£420
SP-CUP Integral cupboard under - c/w lockable hinged doors	£660
SP- MO Mobile option - 125mm castors fitted	£105

Adjustable height Prep / Table



SP-TV-05

Code	Dimensions	Undershelf	£
SP-TV-01	1200x650x780-1020mm high	1	£3,300
SP-TV-02	1500x650x780-1020mm high	1	£3,425
SP-TV-03	1800x650x780-1020mm high	1	£3,490
SP-TV-04	1200x750x780-1020mm high	1	£3,425
SP-TV-05	1500x750x780-1020mm high	1	£3,515
SP-TV-06	1800x750x780-1020mm high	1	£3,600

- Grade 304 stainless steel - fully fabricated units.
- Sounddeadened, heavy duty, worktop.
- Hydraulic piston height adjustment.
- Height range 780-1020mm high.
- Undershelf fitted as standard @ 150mm FFL.
- Wall or centre table units available.
- Heavy duty 40x40mm box leg section.
- Alloy adjustable feet fitted as standard.

Options	£
SP-TV-ELEC Electronic operated option - push button control.	POA
SP-TV-IP Infill panels to sides and rear	£420
SP-TV-R Runners (3 prs) under to suit HTM-71 trays	£190
SP-TV- MO Mobile option - 125mm castors fitted	£105

Stainless prep tables - Flat Packed



SP-T-FP-06 with optional undershelf

Code	Dimensions	Undershelf	£
SP-T-FP-01	900x650x875mm high	1	£670
SP-T-FP-02	1200x650x875mm high	1	£800
SP-T-FP-03	1500x650x875mm high	1	£870
SP-T-FP-04	900x750x875mm high	1	£710
SP-T-FP-05	1200x750x875mm high	1	£840
SP-T-FP-06	1500x750x875mm high	1	£915

- Grade 304 stainless steel construction - flat packed design- self assembly units. Pre-assemble service available.
- Sounddeadened, heavy duty, worktop.
- Wall units c/w 75mm upstand to worktop rear.
- Centre units c/w 50mm downturn to all sides.
- Units c/w worktop and "H" stability frame as standard (Undershelf optional and sold separately).
- Alloy adjustable feet fitted as standard.

Options	£
SP-FP-U-1 Undershelf to suit SP-T-01/02/03 models (in lieu of "h" frame)	£80
SP-FP-U-2 Undershelf to suit SP-T-04/05/06 models (in lieu of "h" frame)	£95
SP-FP-DR Drawer unit (600mm)	£195
SP-FP-KT Retractable keyboard tray (600mm)	£130
SP- MO Mobile option - 125mm castors fitted	£105

WORKSTATIONS / WALL STORAGE

MEDICAL TABLES

Workstations - Flatpacked



SP-WS-05

- Stainless steel construction. Flat packed design - self assembly unit. Pre-assembled service available.
- Standard units comprise of worktop / 1x undershelf / 2x overshelves
- Standard worktop depth 650mm. Also 700 and 600mm available.
- Worktop height @ 875mm high. Overall unit height 1700mm high
- Overshelf depth = 300mm
- Overshelves / Undershelf set at any desirable height. Adjustable @ 25mm increments.
- Numerous options / accessories can be added to form customised / ergonomical unit.



SP-WS-DR

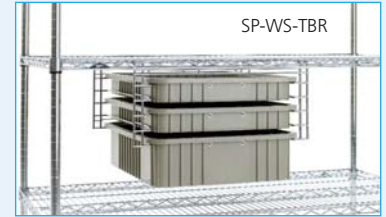

SP-WS-TBR



SP-WS-KT



SP-WS-UB

Code	Dimensions	Undershelves	Overshelves	£
SP-WS-01	900x650x875 / 1700mm high	1	2	£790
SP-WS-02	1200x650x875 / 1700mm high	1	2	£905
SP-WS-03	1500x650x875 / 1700mm high	1	2	£990
SP-WS-04	900x750x875 / 1700mm high	1	2	£850
SP-WS-05	1200x750x875 / 1700mm high	1	2	£965
SP-WS-06	1500x750x875 / 1700mm high	1	2	£1,040

Options	£
SP-WS-BF Hanging back frame	£230
SP-WS- PRD Paper roll dispenser	£135
SP-WS- TBR Tote box runners (tote boxes sold separately)	£185
SP-WS-DR Drawer unit (600mm)	£195
SP-WS-KT Retractable keyboard tray (600mm)	£130
SP-WS-UB Hook -on utility basket 600x250x150mm high	£145
SP-WS-US Hook -on utility shelf 600x300x300mm high	£180
SP-WS-MOB Mobile option - 125mm castors fitted	£105

Stainless solid wall shelves



2 tier solid format shelf unit on 500mm high wall battens

Solid Format

Code	Shelf length dimensions	300mm depth	400mm depth
WS-SS-1	900mm	£170	£185
WS-SS-2	1000mm	£180	£195
WS-SS-3	1200mm	£190	£210
WS-SS-4	1500mm	£220	£235
WS-SS-5	1800mm	£235	£250
WS-SS-6	2000mm	£270	£290
WS-SS-7	2400mm	£290	£305

- Stainless steel formed construction - 1.2mm plate.
- Hygienic, one piece design.
- Upstand 25mm high to rear of all shelves to protect wall surfaces.
- Clip on design allows easy height adjustment / removal for cleaning.
- Prices above are for shelves only - please choose desired wall battens.

Wall Battens - per set

Code	Dimensions	Shelf capacity	£ per set
WS-SB-1	Wall batten 300mm high	1	£45
WS-SB-2	Wall batten 500mm high	2	£55
WS-SB-3	Wall batten 1200mm high	up to 5	£75
WS-SB-4	Wall batten 1500mm high	up to 7	£90

- Stainless wall battens slotted @ 25mm increments.
- Design allows 2x shelves to locate in same slot to allow continuous runs to be formed.

"Hook-on" dispensing shelves (complete 2 tier unit)



Dispensing shelves

Code	Basket dimensions	£
WS-DS-2T-1	600x200x300mm high	£256

- Electro-polished stainless construction - 2 tier unit.
- Stainless solid base - ideal for storage of single items.

Wall Battens - per set

Code	Dimensions	Shelf capacity	£ per set
WS-WB-5	Wall batten 300mm high	1	£44
WS-WB-6	Wall batten 600mm high	2	£58
WS-WB-7	Wall batten 900mm high	up to 3	£80
WS-WB-8	Wall batten 1500mm high	up to 5	£101

- Stainless 25x25mm box section.
- Hooks set @ 300mm increments.
- Fixing holes pre-drilled and c/w plastic wall spacer (fixings included)

“Hook on” clog shelves



Clog Shelves

Code	Basket dimensions	capacity	£
WS-CS-1	600x305x200mm high	6 prs	£131

- Stainless wire construction.
- Electro polished finish.

Wall Battens - per set

Code	Dimensions	Shelf capacity	£ per set
WS-WB-5	Wall batten 300mm high	1	£44
WS-WB-6	Wall batten 600mm high	2	£58
WS-WB-7	Wall batten 900mm high	up to 3	£80
WS-WB-8	Wall batten 1500mm high	up to 5	£101

- Stainless 25x25mm box section.
- Hooks set @ 300mm increments.
- Fixing holes pre-drilled and c/w plastic wall spacer (fixings included)

“Hook on” catheter rail



Code	Basket dimensions	Hooks	£
WS-CR-8H	600x200x80mm high	8 @ 180mm	£112

- Stainless wire construction.
- Electro polished finish.
- 8 hooks each with 180mm projection.

“Hook-on” utility baskets



Utility Basket

Code	Basket dimensions	£
WS-UB-1	600x250x150mm high	£145

- Electro-polished stainless wire construction.
- Solid stainless identification plate fitted as standard.
- Base mesh 20x20mm.

Wall Battens - per set

Code	Dimensions	Basket capacity	£ per set
WS-WB-1	Wall batten 300mm high	1	£44
WS-WB-2	Wall batten 600mm high	3	£58
WS-WB-3	Wall batten 900mm high	up to 4	£80
WS-WB-4	Wall batten 1500mm high	up to 7	£101

- Stainless 25x25mm box section.
- Hooks set @ 200mm increments.
- Fixing holes pre-drilled and c/w plastic wall spacer (fixings included).

“Hook-on” utility shelf



Utility Shelf

Code	Basket dimensions	£
WS-US-1	600x300x300mm high	£180

- Electro-polished stainless construction.
- Wire back and side panels.
- Stainless solid base - removable for cleaning.

Wall Battens - per set

Code	Dimensions	Shelf capacity	£ per set
WS-WB-5	Wall batten 300mm high	1	£44
WS-WB-6	Wall batten 600mm high	2	£58
WS-WB-7	Wall batten 900mm high	up to 3	£80
WS-WB-8	Wall batten 1500mm high	up to 5	£101

- Stainless 25x25mm box section.
- Hooks set @ 300mm increments.
- Fixing holes pre-drilled and c/w plastic wall spacer (fixings included)

“Hook-on” bulk storage baskets



Bulk Basket

Code	Basket dimensions	£
WS-BSB-1	600x300x300mm high	£186

- Electro-polished stainless wire construction.
- Solid stainless identification plate fitted as standard.
- Base mesh 20x20mm.

Wall Battens - per set

Code	Dimensions	Basket capacity	£ per set
WS-WB-5	Wall batten 300mm high	1	£44
WS-WB-6	Wall batten 600mm high	2	£58
WS-WB-7	Wall batten 900mm high	up to 3	£80
WS-WB-8	Wall batten 1500mm high	up to 5	£101

- Stainless 25x25mm box section.
- Hooks set @ 300mm increments.
- Fixing holes pre-drilled and c/w plastic wall spacer (fixings included)

Polycarbonate HTM-71 Trays



HT-PCT-03

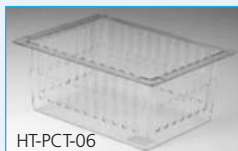

HT-PCT-06

Code	HTM size	Dimensions	£
HT-PCT-01	Full size	600x400x50mm high	POA
HT-PCT-02	Full size	600x400x100mm high	POA
HT-PCT-03	Full size	600x400x200mm high	POA
HT-PCT-04	Half size	400x300x50mm high	POA
HT-PCT-05	Half size	400x300x100mm high	POA
HT-PCT-06	Half size	400x300x200mm high	POA

- Made from 3mm Polycarbonate (Clear) material with 5mm thick top flange.
- Allows optimal storage of consumables.
- Autoclave compatible.
- Resistant to Hydrogen Peroxide Fogging.
- Unique slotted design to accept dividers.

Polycarbonate HTM-71 Tray Dividers



Code	To suit HTM tray	Dimensions	£
HT-PCD-01	HT-PCT-01	600x50mm high	POA
HT-PCD-02	HT-PCT-01	400x50mm high	POA
HT-PCD-03	HT-PCT-02	600x100mm high	POA
HT-PCD-04	HT-PCT-02	400x100mm high	POA
HT-PCD-05	HT-PCT-03	600x200mm high	POA
HT-PCD-06	HT-PCT-03	400x200mm high	POA
HT-PCD-07	HT-PCT-04	400x50mm high	POA
HT-PCD-08	HT-PCT-04	300x50mm high	POA
HT-PCD-09	HT-PCT-05	400x100mm high	POA
HT-PCD-10	HT-PCT-05	300x100mm high	POA
HT-PCD-11	HT-PCT-06	400x200mm high	POA

- Made from 3mm Polycarbonate (Clear) material.
- Autoclave compatible.
- Resistant to Hydrogen Peroxide Fogging.
- Positive location and ease of adjustment.
- Enables multiple permutations to divide tray.

Chrome Wire Shelving - Ledges / Dividers

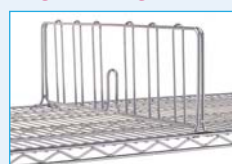

Wire Ledges

Code	To suit shelf size	Ledge Dimensions	Chrome £	St/St £
SA-WL-300	300mm deep	300x100mm high	£14	£30
SA-WL-400	400mm deep	400x100mm high	£15	£32
SA-WL-500	500mm deep	500x100mm high	£16	£35
SA-WL-600	600mm deep	600x100mm high	£16	£29
SA-WL-800	800mm long	800x100mm high	£19	£52
SA-WL-900	900mm long	900x100mm high	£22	£54
SA-WL-1000	1000mm long	1000x100mm high	£24	£61
SA-WL-1200	1200mm long	1200x100mm high	£27	£69
SA-WL-1500	1500mm long	1500x100mm high	£31	£78
SA-WL-1800	1800mm long	1800x100mm high	£35	£95

- Chrome or Stainless steel wire ledges - 100mm high.
- Clip-on design - allows easy assembly.
- Please note 2x depth ledges and 1x length ledge normally required per shelf.
- When ordering Stainless steel please suffix above code with letter "S"

Wire Dividers

Code	To suit shelf size	Divider Dimensions	Chrome £	St/St £
SA-WD-300	300mm deep	300x200mm high	£16	£47
SA-WD-400	400mm deep	400x200mm high	£19	£52
SA-WD-500	500mm deep	500x200mm high	£21	£60
SA-WD-600	600mm deep	600x200mm high	£25	£64

- Chrome or Stainless steel wire dividers - 200mm high.
- Clip-on design - allows easy assembly.
- When ordering Stainless steel please suffix above code with letter "S"

Plastic Tote Boxes

Tote boxes as used with Tote runners



Tote box with dividers



Boxes

Code	Dimensions	£
SA-PTB-01	572x445x76mm high	£35
SA-PTB-02	572x445x127mm high	£44
SA-PTB-03	572x445x152mm high	£50
SA-PTB-04	572x445x203mm high	£56

- Manufactured from ABS plastic.
- Impervious to acids / oils / detergents and blood.
- Suitable to use with Tote box runners.
- Optional dividers allowing tote to become compartmentalised.

Dividers

Code	Dimensions	Used with tote box	£
SA-PTB-01-SD	Short divider 384x70mm	SA-PTB-01	£9
SA-PTB-01-LD	Long Divider 514x70mm	SA-PTB-01	£10
SA-PTB-03-SD	Short divider 384x145mm	SA-PTB-03	£10
SA-PTB-03-LD	Long Divider 514x145mm	SA-PTB-03	£10
SA-PTB-04-SD	Short divider 384x198mm	SA-PTB-04	£10
SA-PTB-04-LD	Long Divider 514x198mm	SA-PTB-04	£10

Stainless Wire Trays + Pans



Code	Compatible with	Dimensions	£
SA-WT-01	HTM Trolleys / Cabinets	600x400	£32
SA-WT-02	Blood bank refrigerated cabinets	650x530	£36
SA-PAN-01	Aluminium shelving system	530x325x100mm	£49
SA-PAN-02	Aluminium shelving system	530x325x150mm	£66

- Electro-polished stainless steel wire trays.
- Bright polished stainless pans - available in 2x depths.
- Trays allow air circulation and light penetration.
- Pans ideal for storage of single items.
- Both autoclave compatible.

Metro Q Shelving - Ledges / Dividers



Polymer Stackable Ledges

Code	To suit shelf size	Ledge Dimensions	£
SA-PL-457	457mm deep	457x50mm high	£26
SA-PL-533	533mm deep	533x50mm high	£26
SA-PL-610	610mm deep	610x500mm high	£27
SA-PL-610	610mm long	610x500mm high	£27
SA-PL-760	760mm long	760x50mm high	£27
SA-PL-910	910mm long	910x50mm high	£33
SA-PL-1066	1066mm long	1066x50mm high	£37
SA-PL-1220	1220mm long	1220x50mm high	£41
SA-PL-1525	1525mm long	1525x50mm high	£46
SA-PL-1830	1830mm long	1830x50mm high	£52

- Polymer ledges - individual height = 50mm.
- Design allows ledges to be stackable - can be increased to any desired height.
- Clip-on design - allows easy assembly.

Polymer Dividers

Code	To suit shelf size	Divider Dimensions	£
SA-PD-457	457mm deep	457x200mm high	£28
SA-PD-610	610mm deep	610x200mm high	£32

- Polymer dividers - 200mm high.
- Clip-on design - allows easy assembly.

