

Crimp Contacts

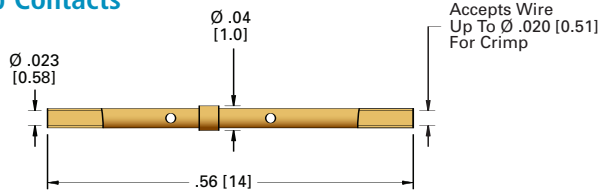

Figure 1

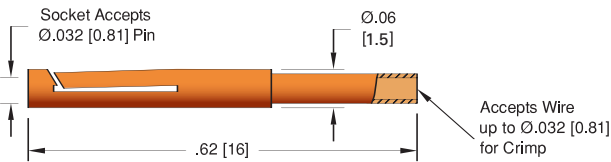

Figure 2

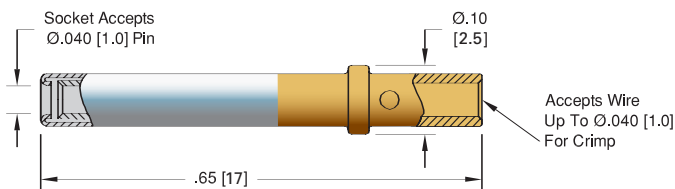

Figure 3

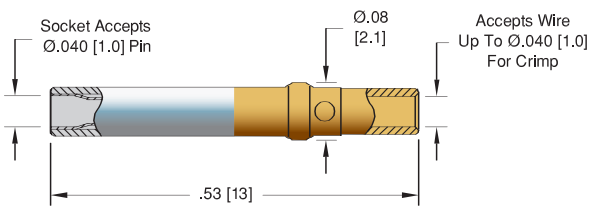

Figure 4

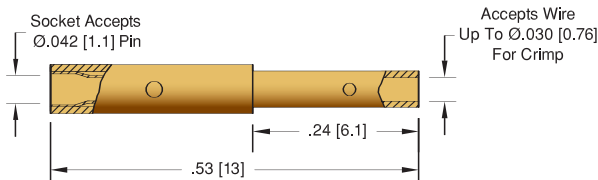

Figure 5

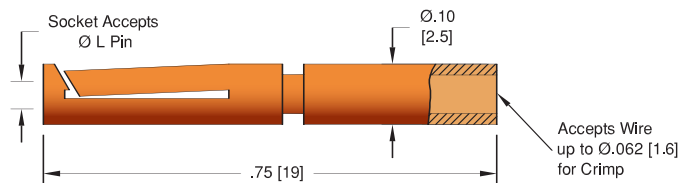

Figure 6

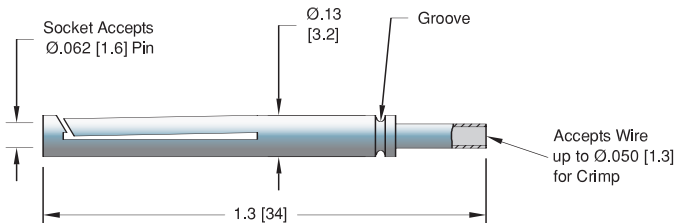

Figure 7

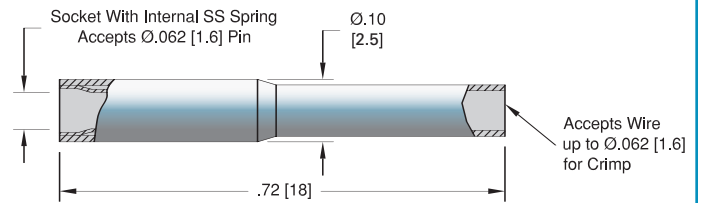

Figure 8

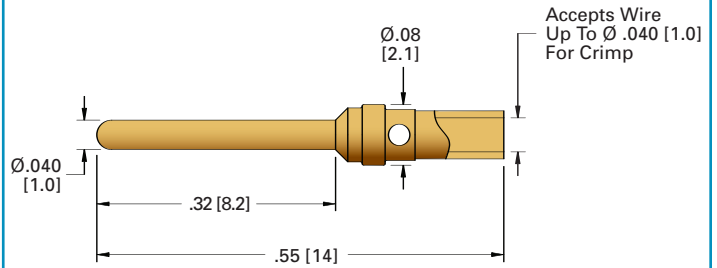

Figure 9

Set Screw Type Contacts

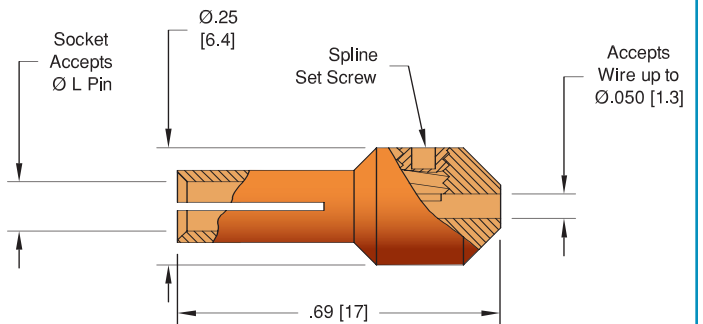

Figure 10

Barrel Type Contacts

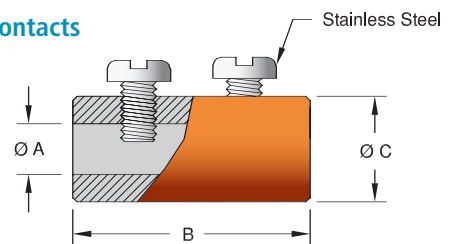

Figure 11

Clamp Type Contacts

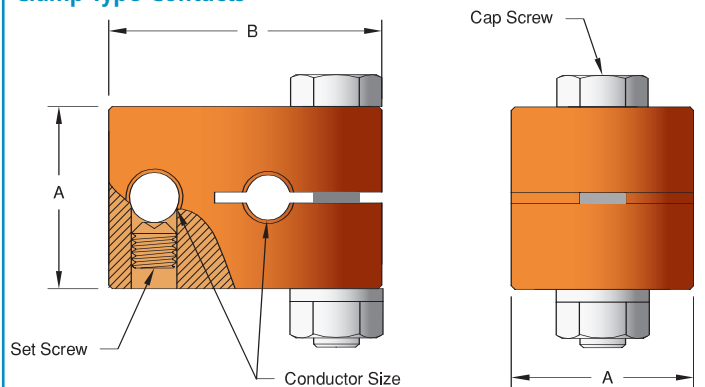

Figure 12

ACCESSORIES



ACCEPTS PIN DIA.	FIGURE	MATERIAL	CURRENT AMPS	TEMPERATURE MIN	TEMPERATURE MAX	GROOVE	GOLD PLATED	QTY/PK	PART NUMBER
.020 [0.51]	1	Beryllium Copper	2	-269	200	-	Yes	5/Pk	21466-02-A
.032 [0.81]	2	Beryllium Copper	16	-269	200	-	No	10/Pk	11288-02-X†
.040 [1.0]	3	Copper Alloy - Gold Flash	15	-200	200	-	No	5/Pk	16167-03-A
.040 [1.0]	4	Copper Alloy - Gold Flash	15	-200	200	-	No	5/Pk	16757-02-A
.042 [1.1]	5	Stainless Steel	2	-269	450	-	Yes	5/Pk	14461-04-A
.050 [1.3]	6	Beryllium Copper	20	-269	200	-	No	10/Pk	11911-02-X
.062 [1.6]	6	Beryllium Copper	20	-269	200	-	No	10/Pk	2044-02-A
.062 [1.6]	7	Chromel	-	-269	350	Yes	No	5/Pk	11259-05-X
.062 [1.6]	7	Alumel	-	-269	350	No	No	5/Pk	11259-06-X
.062 [1.6]	8	Nickel Alloy	10	-269	400	-	No	10/Pk	0821-01-A



MALE PIN DIA.	FIGURE	MATERIAL	CURRENT AMPS	TEMPERATURE MIN	TEMPERATURE MAX	GOLD PLATED	QTY/PK	PART NUMBER
.040 [1.0]	9	Copper Alloy	15	-200	200	Yes	5/Pk	17412-02-A

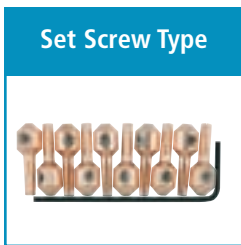

DIAMETER L	FIGURE	MATERIAL	CURRENT AMPS	TEMPERATURE MIN	TEMPERATURE MAX	QTY/PK	PART NUMBER
0.040 [1.0]	10	Beryllium Copper	20	-269	200	10	7429-03-A
0.050 [1.3]	10	Beryllium Copper	25	-269	200	10	7429-02-A
0.094 [2.4]	10	Beryllium Copper	25	-269	200	10	7429-01-A

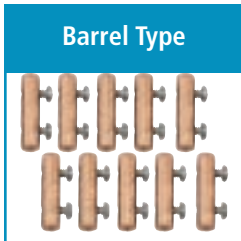

DIAMETER A	FIGURE	MATERIAL	CURRENT AMPS	DIMENSIONS B C		TEMPERATURE MIN	TEMPERATURE MAX	QTY/PK	PART NUMBER
0.040 [1.0]	11	Beryllium Copper	13	0.50 [12.7]	0.13 [3.2]	-269	400	10	7332-01-A
0.050 [1.3]	11	Beryllium Copper	20	0.50 [12.7]	0.19 [4.8]	-269	400	10	7332-02-A
0.062 [1.6]	11	Beryllium Copper	20	0.50 [12.7]	0.19 [4.8]	-269	400	10	7332-03-A
0.094 [2.4]	11	Beryllium Copper	25	0.56 [14.2]	0.25 [6.4]	-269	400	10	7332-04-A
0.125 [3.2]	11	Beryllium Copper	25	0.63 [16.0]	0.25 [6.4]	-269	400	10	7332-05-A
0.154 [3.9]	11	Beryllium Copper	30	0.75 [19.1]	0.33 [8.3]	-269	400	10	7332-07-A
0.250 [6.4]	11	Beryllium Copper	35	1.00 [25.4]	0.50 [12.7]	-269	400	10	7332-06-A



CONDUCTOR SIZE	FIGURE	MATERIAL	CURRENT AMPS	DIMENSIONS A B		TEMPERATURE MIN	TEMPERATURE MAX	PART NUMBER
0.250 [6.4]	12	Copper	350	1.0 [25]	1.5 [38]	-269	400	18740-01-A
0.375 [9.5]	12	Copper	400	1.0 [25]	2.4 [60]	-269	400	18737-01-A
0.500 [12.7]	12	Copper	500	1.0 [25]	2.4 [60]	-269	400	18738-01-A
0.750 [19.1]	12	Copper	1000	1.5 [38]	3.1 [79]	-269	400	18739-01-A



DESCRIPTION	PART NUMBER
Crimp tool for .025" - .075" crimp diameters	2840-05

†Shown in photo.