

Intelligent Drive Systems, Worldwide Services

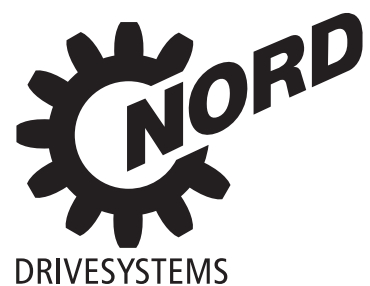

SK 500E

F 3050 GB



Universal application

Compact modular inverter: NORDAC SK 500E

Getriebebau NORD offers intelligent and cost-effective drive solutions with the frequency inverters in the SK 500E product series and their scaleable equipment options, all of which are fully compatible with regard to motor performance range, supply voltage and sizes. The basis for all models is a well-equipped basic unit with expansion possibilities through optional modules. SK 500E inverters are suitable for numerous application areas and can be easily adapted to specific requirements with plug-in technology units.

Power range for the SK 500E series

- ✓ 1~ 115V 0,25 - 0,75 kW
- 1/3~ 230V 0,25 - 11 kW
- 3~ 480V 0.55 - 22 kW

- ✓ Cold Plate / External heat sink technology
- ✓ Safety technology
- ✓ Ethernet-enabled bus systems
- ✓ Positioning control
- ✓ ATEX compliance
- ✓ RoHS compliance

Performance levels:

The SK 500E range offers a wide range of application-specific features necessary for drive solutions. These can be used with various levels of the version "in the same housing". They contain the following typical state-of-the-art industrial functions.

- "Safe Stop" as per EN 954-1, max. Cat. 4
- CANopen interface on board
- Incremental encoder input (TTL) on board
- Absolute value encoder via CANopen
- Positioning control POSICON
- External 24V power supply for control card

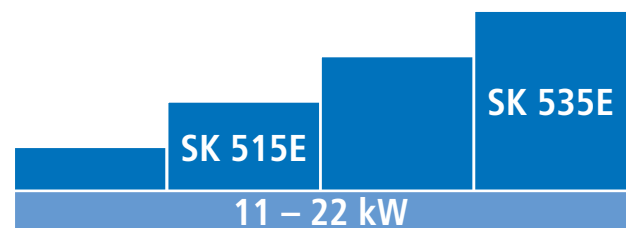
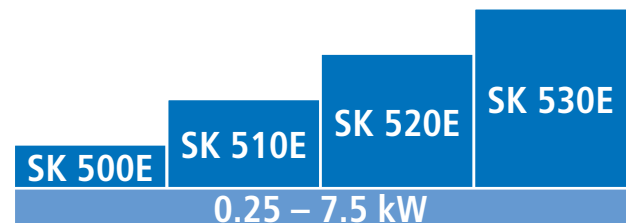



System Overview



Technology units





		SK 500E	SK 505E	SK 510E	SK 511E	SK 520E	SK 530E	SK 535E
Power	Power range 0.25 kW - 7.5 kW	✓	✓	✓		✓	✓	✓
	Power range 11 kW - 22 kW (up to 160 kW in preparation)				✓			✓
Basic functions	Same design	✓	✓	✓	✓	✓	✓	✓
	Cold Plate, external heat sink technology	✓	✓	✓	✓	✓	✓	✓
Basic functions	Sensorless current vector control (ISD control)	✓	✓	✓	✓	✓	✓	✓
	Class A mains filter, up to 5m motor cable Class B	✓	✓	✓	✓	✓	✓	✓
	Brake management, mechanical holding brake	✓	✓	✓	✓	✓	✓	✓
	Brake chopper (brake resistor optional)	✓	✓	✓	✓	✓	✓	✓
	Switchable parameter sets	✓	✓	✓	✓	✓	✓	✓
	All normal drive functions	✓	✓	✓	✓	✓	✓	✓
	Process controller / PID controller	✓	✓	✓	✓	✓	✓	✓
	Comprehensive parameter structure	✓	✓	✓	✓	✓	✓	✓
	Simple to operate	✓	✓	✓	✓	✓	✓	✓
	All current bus systems	✓	✓	✓	✓	✓	✓	✓
Automatic flux optimisation (energy saving function) NEW	✓	✓	✓	✓	✓	✓	✓	
Special Option	"Safe Stop" function			✓	✓		✓	✓
	CANopen on board					✓	✓	✓
	Incremental encoder input					✓	✓	✓
	Additional control signals					✓	✓	✓
	POSICON (Positioning control, synchronous operation, relative and absolute position control)						✓	✓
	Further variants with external 24 V power supply		✓		✓ (11-22kW)			✓

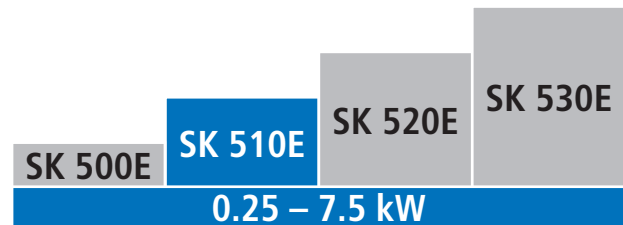
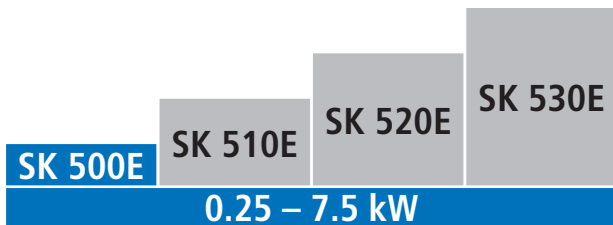

SK 500E

SK 500E basic equipment:

- ✓ Sensorless current vector control (ISD control)
- ✓ Mains filter Class A, Class B up to 5m
- ✓ Brake management, electro-mechanical holding brake
- ✓ Brake chopper (brake resistance)
- ✓ RS 232 diagnostic interface
- ✓ Switchable parameter sets
- ✓ All normal drive functions
- ✓ Automatic flux optimisation (Energy saving function)
- ✓ Process controller / PID controller
- ✓ Comprehensive parameter structure
- ✓ Simple to operate
- ✓ All standard bus systems

With its comprehensive basic equipment, the SK 500E can be used to implement a large number of applications. All functions can be found in the entire product range. Handling and control is very simple and easy to use, so that commissioning is child's play.

SK 510E

SK 510E with "Safe Stop" safety function as per EN 954-1

- ✓ SK 500E basic equipment
- ✓ Safety function "Safe Stop"

The safety function "Safe Stop" is a very practical and efficient way of preventing a motor from restarting, in compliance with industry standards. This prevents people working in the vicinity from being injured by the rotating drive. ("Safe Stop", see page 12)

Integrated function "Safe Stop" as per EN 954-1 or EN 13849-1 up to max. safety category 4
Stop category 0 and 1

- "Safe impulse block" with external 24V supply
- Safety switching device required
- Safe protection against motor restart
- No need for switching off the supply voltage

SK 511E with "Safe Stop" safety function and CANopen on board



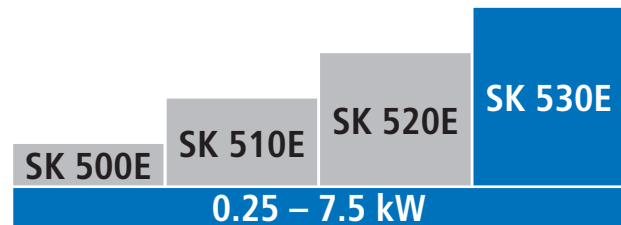
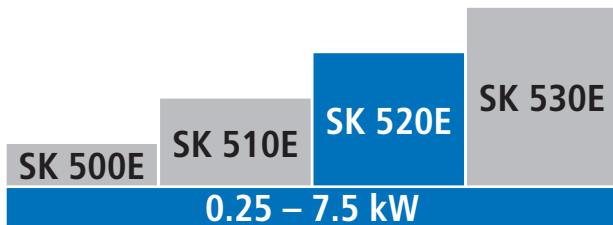

SK 520E

SK 520E with speed regulation and efficient bus system:

- ✓ SK 500E basic equipment
- ✓ Incremental encoder input (TTL)
- ✓ CANopen on board
- ✓ Additional control signals

With the incremental encoder input, accurate speed control can be achieved for increased speed stability and full torque down to zero speed (e.g. lifting applications). The integral CANopen interface provides a low cost for connection to automation systems. Additional control signals provide expanded scope for processing external inputs and outputs.

SK 530E

SK 530E with safety technology and positioning control

- ✓ SK 520E basic equipment
- ✓ Safety function "Safe Stop"
- ✓ Positioning control POSICON
- ✓ Incremental encoder input (TTL)
- ✓ CANopen on board
- ✓ Additional control signals

When you need to control positioning applications with a standard asynchronous motor, NORDAC frequency inverters are available with this function. In their upgraded versions, the proven device series SK 530E and SK 535E provide user-friendly methods for implementing relative or absolute position control. Commissioning with a minimum number of parameters makes this high-level functionality easily achievable.

- Absolute value encoder via integral CANopen on board
- Up to 15 positions available
- Binary actuation via bus system



The SK 500E series has been given additional basic functions:

Since 2005

size 1-4
0,25 - 7.5 kW

Since April 2008

size 5+6
11 - 22 kW

In preparation

size 7-9
30 - 160 kW

Now that the SK 500E series is successfully established on the market, the power range has now been extended to 22 kW. With this, the success factors of

this component are now being extended to a wider field of applications.



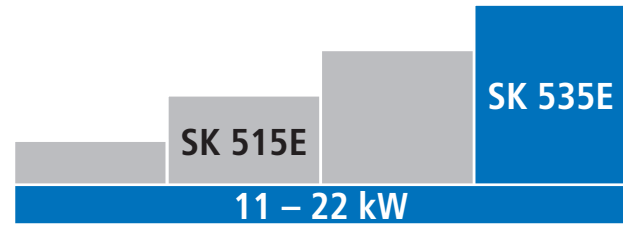
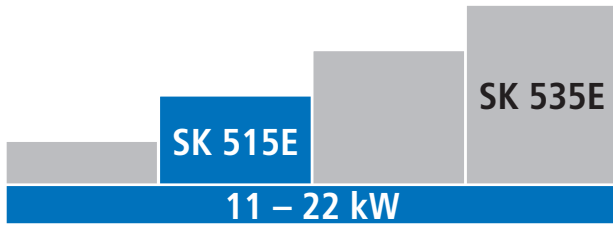

SK 515E

SK 515E with safety technology, bus system and online availability

- ✓ SK 500E basic equipment
- ✓ Safety function "Safe Stop"
- ✓ CANopen on board
- ✓ External 24V supply for the control card

In the large power range above 11 kW, the SK 500E series already has several features as standard. The SK 515E has the well-known "Safe Stop" function as per EN 954-1 and the CANopen bus system on board.

In addition, all units of this power range provide the facility of operating the control card with an external 24V supply. With this, online availability can be ensured, even when the power is switched off. This can be used e.g. for evacuation movement for lift applications.

SK 535E

SK 535E with all available features and functionalities

- ✓ SK 500E basic equipment
- ✓ Safety function "Safe Stop"
- ✓ CANopen on board
- ✓ External 24V supply for the control card
- ✓ Incremental encoder input (TTL)
- ✓ Additional control signals
- ✓ Positioning control POSICON

The SK 535E provides the highest level of performance. This provides a cost-orientated solution, with a high degree of functionality.

Always stay cool

Alternative cooling systems "Cold-Plate" and external heat sink technology

In addition to the standard cooling technology designs, all SK 500E inverters are also available as Cold-Plate and external heat sink technology. In the Cold-Plate variant, the standard heat sink is replaced by a flat cooling flange. To transfer the heat from the inverter, the flange is mounted on a surface cooled by e.g. water, air or oil. Important advantages here are the reduction in installation depth of the inverter by approx. 35 mm to 119 mm and improved heat dissipation.

With the external heat sink technology, an extruded heat sink is supplied as an optional module and mounted on the Cold-Plate unit. The inverter is installed in the electrical cabinet with the heat sink located outside the cabinet so that a large part of the heat to be dissipated is transferred there. This reduces the cooling requirement of the cabinet – air conditioners and fans can be correspondingly smaller or completely omitted.



Cold-Plate



External heat sink technology

Explosion-free zone

ATEX compliant drive systems for increased safety

Tested and certified combinations of SK 500E inverters and NORD motors with increased safety are available. In cases where typically, pressure-resistant encapsulated motors need to be used for inverter operation, a combination of explosion-protected motor and NORD SK 500E frequency inverter can be used. This results in a considerable saving of costs. The weight and price of such a drive package is competitive when compared to the motor performance and therefore offers an efficient solution.

Advantages at a glance:

- Up to 40% price advantage for the gear motor compared to drives with pressure-resistant motors
- Significant weight reduction
- PTB approval for Zone 1 and Zone 2
- 50 Hz or 87 Hz characteristic curve possible
- Control range 5 Hz to 100 Hz
- Power range from 0.18 to 13.5 kW (Motor output)

ATEX
konform



Cold-Plate



External heat sink

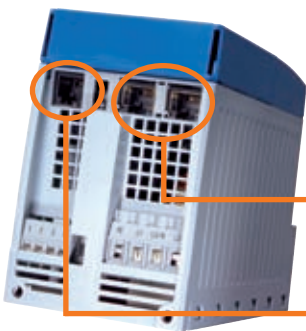
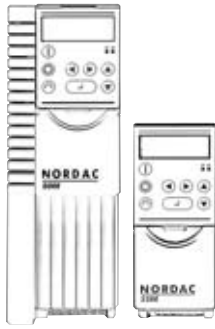

Interfaces	SK 500E	SK 505E	SK 510E	SK 511E	SK 515E	SK 520E	SK 530E	SK 535E
5x digital inputs 2x analog inputs (0...10V, 0/4...20mA) 1x analog output 2x multi-function relays RS 485 and RS 232 on RJ 12 socket	✓	✓	✓	✓	✓	✓	✓	✓
1x Incremental encoder input						✓	✓	✓
2x digital inputs 2x digital outputs 1x RS 485 to terminals						✓	✓	✓
External 24V control card power supply		✓			✓			✓
Safety function "Safe Stop"			✓	✓	✓		✓	✓
Positioning control POSICON							✓	✓
2x RJ 45 for CANopen In/Out				✓	✓	✓	✓	✓
1xRJ 12 for operation and diagnosis	✓	✓	✓	✓	✓	✓	✓	✓

Safety function "Safe Stop"

Safety function "Safe Stop"

Personnel safety and high machine availability are the focus in system operations. After a safety circuit is actuated by opening a safety cover or door, it must be ensured that no rotating system components can lead to accidents at work. This is triggered by a safe impulse block in an asynchronous motor with NORDAC frequency inverter, offering certified protection from the motor restarting. This safe block includes voltage supply to the circuit breaker by means of a safety switching device. The frequency inverter is therefore immediately ready to be switched on without re-initialisation after the safety circuit is closed.

Standards

- EN 13849-1: Performance Level e
- EN 61508: SIL3
- EN 60204-1: Stop function
- pr EN 61800-5-2: Safety functions

Applications

- Rotating machining tools (e.g. milling)
- Closed moving systems with safety doors

Advantages at a glance

- High availability through continuous online operation
- Savings on circuit breaker components
- No inverter initialisation delays
- Long service life through electronic switching (No electro-mechanical contacts)
- Low cost solution with compact device

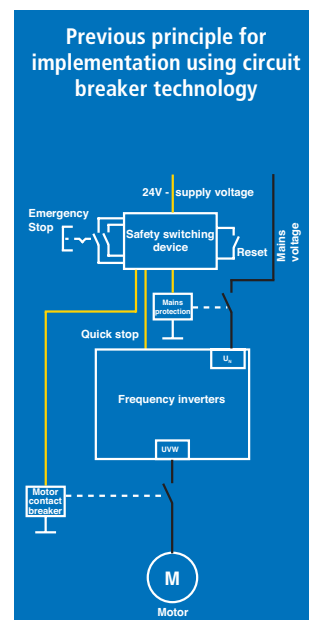
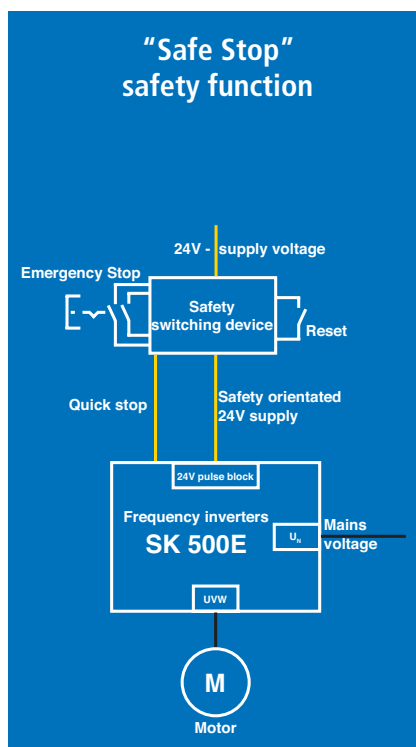

Ethernet-based BUS systems

Gateway solution



Gateway RS232 / Standard Ethernet
Available 04/2007
Access via NORD CON, e.g. remote maintenance

EtherCAT

Available 04/2009

PROFINET, Powerlink, EtherNet/IP

In preparation



NORD CON

NORD CON is the free operating software for controlling, parameterisation and diagnosis of all NORD frequency inverters.

Control

The connected frequency inverted can be manually operated by means of a software window with all the operating elements of a ControlBox. An enable signal with specification of setpoint values can be given. The parameter settings can be adjusted and read parameters (information and error messages) can be viewed. With this, the user has a support aid for each start-up.

Parameterisation

By means of a convenient overview the user can view and adjust each available parameter. By means of an appropriate printing option, parameter lists are generated in printed form either completely or simply with amended values. The completed data sets can be stored on a laptop/PC and archived for further use.



Flexible through modular design

Technology boxes for operation

For parameterisation and control, technology units ensure optimum flexibility: According to the complexity of the application and the required degree of comfort, parameter orientated operation (ControlBox), instruction-free commissioning (ParameterBox) or potentiometer operation (PotentiometerBox) are possible.



SimpleBox

Control panel with 7-segment display and rotating switch for control and parameterisation with plug-in bus technology unit.



ControlBox

Control panel with 4-digit 7-segment display for direct parameterisation and diagnosis.



ParameterBox

Control panel with plain text display for text-controlled commissioning, parameterisation and control of the frequency inverter.



PotentiometerBox

Control panel with On/Off button and setpoint potentiometer for control directly on the device .





Technology unit for communication

By means of external plug-in technology units, SK 500E inverters can be adapted to the requirements of specific applications. Adapter modules are available to suit all common field buses, so that the inverters can be seamlessly integrated into existing automation architectures.



Profibus

Bus module for control, parameterisation and diagnosis of the frequency inverter via Profibus. Connection via SUB-D interface. Internal power supply in the device.
Baud rate: 1.5 MBit/s



Profibus 24V

As for "Profibus", but with external 24V power supply. The module remains online, even when the frequency inverter is switched off. Bus address and baud rate (max 12 Mbit/s) can be set by means of a rotary coding switch.



CANopen

Bus module for control, parameterisation and diagnosis of the frequency inverter via CANopen. Bus address and baud rate can be set on the module for direct start-up.



DeviceNet

Bus module for control, parameterisation and diagnosis of the frequency inverter via DeviceNet. Bus address and baud rate can be set on the module for direct start-up.



InterBus

Bus module for control, parameterisation and diagnosis of the frequency inverter via InterBus. With plug-in terminals for external 24V power supply.



AS interface

Bus module for control, parameterisation and diagnosis of the frequency inverter via AS interface. With plug-in terminals for max. 2 sensors and 4 actuators and for the connection of PWR and AUX. All normal bus states and the I/O status are visible on the module.

Technical data

Function	Specification
Power/Voltage	1~ 115V 0.25 - 0.75 kW 1/3~ 230V 0.25 - 11 kW (15 kW in preparation) 3~ 480V 0.55 - 22 kW (30-160 kW in preparation)
Standard	<ul style="list-style-type: none"> • Integrated mains filter Class A (Industrial area) • Comprehensive and user-friendly parameter structure • Adaptable for operation in IT network or low leakage current operation • Automatic motor parameter identification
Output frequency	0,0 ... 400.0 Hz
Rated overload capacity	200% for 3.5s, 150% for 60s
Protective measures against	overtemperature, short circuit, earth fault, over/under-voltage, overload, underload
Regulation and control	Sensorless current vector control (ISD), linear V/f characteristic curve Automatic flux optimisation (energy saving function)
Motor temperature monitoring	Temperature sensor (PTC), temperature monitor (bimetal), Temperature sensor (KTY84), I ² t- motor
Standard interfaces	RS 485 (USS), RS 232 (commissioning and diagnosis), CANopen (SK 511E and above)
Ambient temperature	0°C...+40°C (S1- 100% ED), 0°C... +50°C(S3 - 75% ED 15min)
Cooling system	Convection up to 1.1 kW, temperature-controlled fan above 1.5 kW Alternatives: Cold Plate / External heat sink technology
Protection class	IP20





Option	Description
Technology units	Clip-on box for control unit or bus system
Connection cables	Connection cable between SK 500E and PC
Braking resistors	For use of the integrated brake chopper, for energy fed back in generator mode
Input / output chokes	to reduce supply current peaks and for very long motor cables
EMC- Kit	For EMC-compliant screening connection to connecting cables

SK 500E 1 ~ 110 ... 120V and 1/3 ~ 200 ... 240V

Inverter type SK 5xxE...	Mains voltage	Output voltage	Nominal motor output 230 V [kW]	Nominal motor output 240 V [hp]
-250-112-O	1 ~ 110...120V, -/+10%, 47...63Hz	3 AC 0-220...240V	0,25	$\frac{1}{3}$
-370-112-O			0,37	$\frac{1}{2}$
-550-112-O			0,55	$\frac{3}{4}$
750-112-O			0,75	1

Inverter type SK 5xxE...	Mains voltage	Nominal motor output 400 V [kW]	Nominal motor output 480 V [hp]
-250-323-A	1/3 ~ 200...240V, -/+10%, 47...63Hz	0,25	$\frac{1}{3}$
-370-323-A		0,37	$\frac{1}{2}$
-550-323-A		0,55	$\frac{3}{4}$
-750-323-A		0,75	1
-111-323-A		1,1	$1\frac{1}{2}$
-151-323-A		1,5	2
-221-323-A		2,2	3
-301-323-A	3 ~ 200...240V, -/+10%, 47...63Hz	3,0	4
-401-323-A		4,0	5
-551-323-A		5,5	$7\frac{1}{2}$
-751-323-A		7,5	10
-112-323-A		11	15



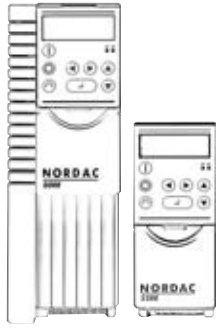

Output	Nominal output current rms[A]	Typical input current rms[A]	Dimensions L x B x D [mm]
	1,7	8	size1: 186 x 74 x 153
	2,2	10	
	3,0	13	
	4,0	18	

Output	Nominal output current rms[A]	Typical input current rms[A]	Dimensions L x B x D [mm]
	1,7	3,7 / 2,4	size1: 186 x 74 x 153
	2,2	4,8 / 3,1	
	3,0	6,5 / 4,2	
	4,0	8,7 / 5,6	
	5,5	12,0 / 7,7	size2: 226 x 74 x 153
	7,0	15,2 / 9,8	
	9,0	19,6 / 13,3	
	12,5	17,5	size3: 241 x 98 x 178
	16,0	22,4	
	20	28,0	size5: 324 x 157 x 224
	27	38,0	
	40	56,0	size6: 364 x 183 x 234



SK 500E 3 ~ 380 ... 480V

Inverter type SK 5xxE...	Mains voltage	Nominal motor output 400 V [kW]	Nominal motor output 480 V [hp]
-550-340-A	3 ~ 380...480V, -20%/+10%, 47...63Hz	0,55	$\frac{3}{4}$
-750-340-A		0,75	1
-111-340-A		1,1	$1\frac{1}{2}$
-151-340-A		1,5	2
-221-340-A		2,2	3
-301-340-A		3,0	4
-401-340-A		4,0	5
-551-340-A		5,5	$7\frac{1}{2}$
-751-340-A		7,5	10
-112-340-A		11,0	15
-152-340-A		15,0	20
-182-340-A		18,5	25
-222-340-A		22,0	30





Output	Nominal output current rms[A]	Typical input current rms[A]	Dimensions L x B x D [mm]
	1,7	2,4	size1: 186 x 74 x 153
	2,3	3,2	
	3,1	4,3	size2: 226 x 74 x 153
	4,0	5,6	
	5,5	7,7	
	7,5	10,5	size3: 241 x 98 x 174
	9,5	13,3	
	12,5	17,5	size4: 286 x 98 x 174
	16	22,4	
	23	32,0	size5: 324 x 157 x 224
	30	42,0	
	37	52,0	size6: 364 x 183 x 234
	45	63,0	

Technology units

	Technology units	Option Type	Material number
Operation		SimpleBox SK CSX-0	275 900 095
		ParameterBox SK TU3-PAR	275 900 100
		ControlBox SK TU3-CTR	275 900 090
		PotentiometerBox SK TU3-POT	275 900 110
Communication		Profibus module SK TU3-PBR	275 900 030
		Profibus module SK TU3-PBR-24V	275 900 160
		CANopen SK TU3-CAO	275 900 075
		DeviceNET SK TU3-DEV	275 900 085
		InterBus SK TU3-IBS	275 900 065
		AS interface SK TU3-AS1	275 900 170





Description	Data
Control panel with 7-segment display and rotary switch for control and parameterisation, as a supplement to a plug-in technology unit.	4-digit, 7-segment LED display, rotary switch
Control panel with plain text display for text-controlled commissioning, parameterisation and control of the frequency inverter.	Plain text display 6 languages Stores 5 data sets
Control panel with 7-segment display and buttons for rapid direct parameterisation and commissioning	4-digit, 7-segment LED display Control buttons Stores 1 data set
For controlling the drive directly from the frequency inverter	Potentiometer 0 to 100% Switch, ON/OFF
Technology unit for all standard bus systems to integrate the frequency inverter into the particular automation environment.	Baud rate: up to 1.5 MBit/s Connector: SUB-D 9-pin
	Baud rate: up to 12 MBit/s Connector: SUB-D 9-pin +24V DC
	Baud rate: up to 1 MBit/s Connector: SUB-D 9-pin
	Baud rate: up to 500 kBit/s 5 pin terminal
	Baud rate: 500 kBit/s (optional 2MBit/s) Connector: 2x SUB-D 9-pin
	4 sensors / 2 actuators 5 and 8 pole terminal

Braking resistors

Heatsink mounted resistors

Inverter type SK 5xxE...		Resistor type	Material number	Resistance [Ω]
230V	... -250-323-A to ... -370-323-A	SK BR4-240/100	275991110	240
	... -550-323-A to ... -750-323-A	SK BR4-150/100	275991115	150
	... -111-323-A to ... -221-323-A	SK BR4- 75/200	275991120	75
400V	... -550-340-A to ... -750-340-A	SK BR4-400/100	275991210	400
	... -111-340-A to ... -221-340-A	SK BR4-220/200	275991220	220

Chassis resistors

Inverter type SK 5xxE		Resistor type	Material number	Resistance []
230V	... -301-323-A to ... -401-323-A	SK BR2- 35/400-C	278282045	35
400V	... -301-340-A to ... -401-340-A	SK BR2-100/400-C	278282040	100
	... -551-340-A to ... -751-340-A	SK BR2-60/600-C	278282060	60
	... -112-340-A to ... -152-340-A	SK BR2-30/1500-C	278282150	30
	... -182-340-A to ... -222-340-A	SK BR2-22/2200-C	278282220	22

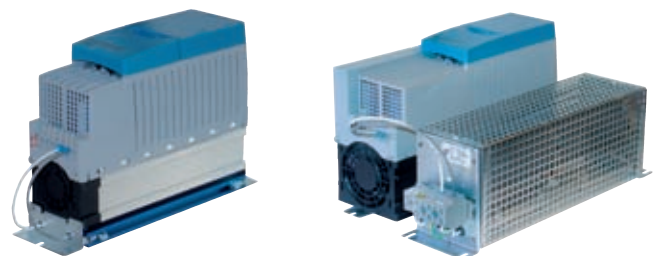

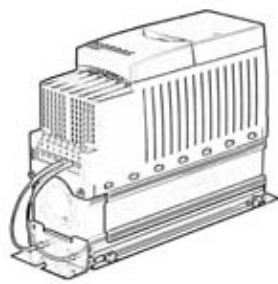

Heatsink mounted resistor (BR4)

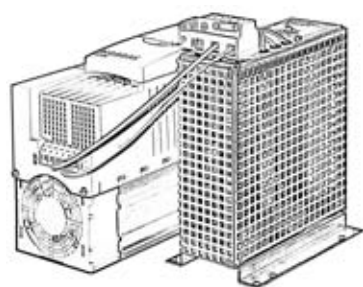

Chassis resistors (BR2)

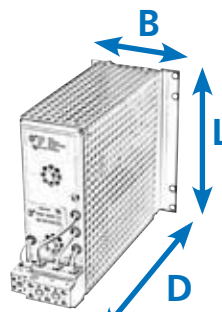

Continuous rating [W]	Energy consumption*) [kWs]	L in [mm]	B in [mm]	D in [mm]
100	1.0	230	88	175
100	1.0	230	88	175
200	4.0	270	88	175
100	0,75	230	88	175
200	4.0	270	88	175

The dimensions apply to the frequency inverter including the braking resistor

Continuous rating [W]	Energy consumption*) [kWs]	L in [mm]	B in [mm]	D in [mm]
400	6.0	170	100	240
400	6.0	170	100	240
600	7,5	350	92	120
1500	–	560	185	120
2200	–	460	270	120

*) permitted, depending on application, max. 5% ED / 120s (700VDC)

Heatsink mounted resistors

This braking resistor can be mounted flat or vertically, next to the frequency inverter (IP20). This reduces space requirements. Three sizes for frequency inverter powers of up to 7.5 kW are available. The specified resistance values are electrically adapted to standard applications.

Chassis resistors

These braking resistors are for universal use. The resistor elements are integrated into a housing grating and must be connected to the particular frequency inverter via a separate connecting cable. For this, a shielded cable should be used, which is as short as possible. These resistors must be protected from heavy soiling and moisture. (Protection type IP20)

Input chokes

1~ 230V

Inverter type SK 5xxE	Choke type IP 20	Material number	Continuous current
0.25 ... 0.75 kW	SK CI1-230/8-C	278999030	8 A
1.1 ... 2.2 kW	SK CI1-230/20-C	278999040	20 A

3~ 230V

Inverter type SK 5xxE	Choke type IP 20	Material number	Continuous current
0.25 ... 0.75 kW	SK CI1-460/6-C	276 995 004	6 A
1.1 ... 1.5 kW	SK CI1-460/11-C	276 995 010	11 A
2.2 ... 3.0 kW	SK CI1-460/20-C	276 995 020	20 A
4 ... 7.5 kW	SK CI1-460/40-C	276 995 040	40 A
11 kW	SK CI1-460/70-C	276 995 070	70 A

3~ 480V

Inverter type SK 5xxE	Choke type IP 20	Material number	Continuous current
0.75 ... 2.2 kW	SK CI1-460/6-C	276 995 004	6 A
3.0 ... 4.0 kW	SK CI1-460/11-C	276 995 010	11 A
5.5 ... 7.5 kW	SK CI1-460/20-C	276 995 020	20 A
11 ... 18.5 kW	SK CI1-460/40-C	276 995 040	40 A
22 kW	SK CI1-460/70-C	276 995 070	70 A

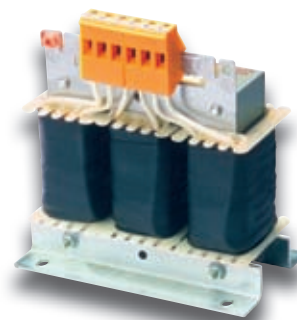

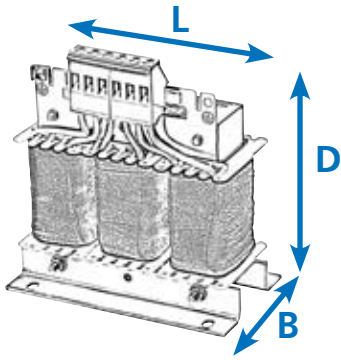

Inductance	L in mm	B in mm	D in mm
2 x 1.0 mH	65	78	89
2 x 0.4 mH	90	96	106

Inductance	L in mm	B in mm	D in mm
3 x 4.88 mH	125	95	140
3 x 2.93mH	155	95	160
3 x 1.47 mH	185	102	201
3 x 0.73 mH	190	122	201
3 x 0.47 mH	230	125	260

Inductance	L in mm	B in mm	D in mm
3 x 4.88 mH	125	95	140
3 x 2.93mH	155	95	160
3 x 1.47 mH	185	102	201
3 x 0.73 mH	190	122	201
3 x 0.47 mH	230	125	260

General information

It may be necessary, for some drive systems, to use input chokes to reduce dangerous mains current peaks. With their use, mains feedback is also considerably reduced and current harmonics are reduced to a minimum.

It is recommended that an input choke is always used for frequency inverters with a power of more than 45KW. This also positively influences the device safety and EMC behaviour. All chokes have protection class IP00 and are UL-certified.



Output chokes

3~ 230V

Inverter type SK 5xxE	Choke type IP 20	Material number	Continuous current
0,25 ... 0.75 kW	SK CO1-460/4-C	276996004	4 A
1.1 ... 1.5 kW	SK CO1-460/9-C	276996009	9 A
2.2 ... 4.0 kW	SK CO1-460/17-C	276996017	17 A
2.2 ... 4.0 kW	SK CO1-460/33-C	276996033	33 A
11 kW	SK CO1-460/60-C	276996060	60 A

3~ 480V

Inverter type SK 5xxE	Choke type IP 20	Material number	Continuous current
0.55 ... 4.0 kW	SK CO1-460/9-C	276996009	9 A
5.5 ... 7.5 kW	SK CO1-460/17-C	276996017	17 A
11 ... 15 kW	SK CO1-460/33-C	276996033	33 A
18 ... 22 kW	SK CO1-460/60-C	276996060	60 A

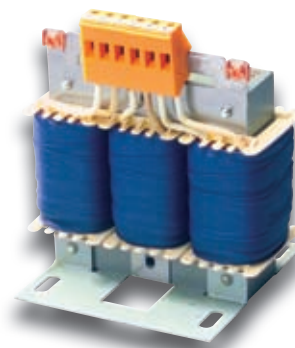

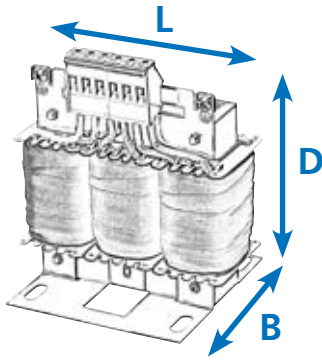

Inductance	L in mm	B in mm	D in mm
3 x 3.5 mH	104	125	140
3 x 2.5 mH	155	110	160
3 x 1.2 mH	185	102	201
3 x 0.6 mH	185	122	201
3 x 0.33 mH	230	125	260

Inductance	L in mm	B in mm	D in mm
3 x 2.5 mH	155	110	160
3 x 1.2 mH	185	102	201
3 x 0.6 mH	185	122	201
3 x 0.33 mH	230	125	260

General information

Large motor cablelengths (cable capacity) often require the use of additional output chokes on the frequency inverter output.

This has a positive effect on device protection and the EMC properties.

The output chokes specified in the tables are rated for a frequency inverter pulse frequency of 3 to 6 kHz and an output frequency of 0 to 120Hz. All chokes have protection class IP00 and are UL-certified.

