



ISO 14001

JQA-EM4057
NITTO KOHKI CO., LTD.
Headquarters
Research Center



ISO 9001

JQA-2042
NITTO KOHKI CO., LTD.
Machine Tools Division

Cat.No. Tk103 m

Nitto Kohki's MACHINE TOOLS

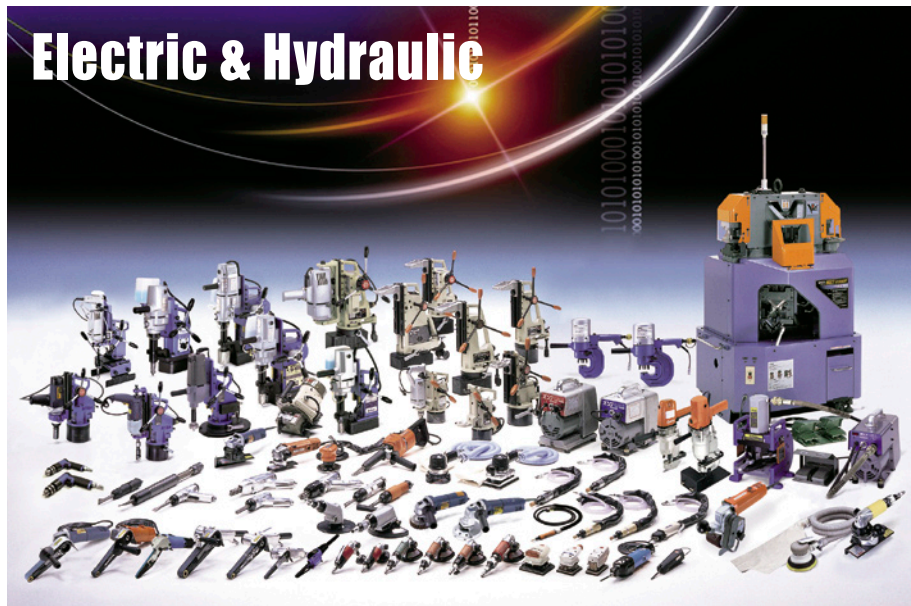
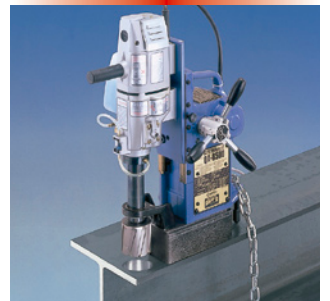

SAFETY GUIDE

Be sure to read and understand all safety precautions mentioned below and to follow the instructions given to operate each Nitto Kohki brand tool as stated in the operator's manual. Keep operators manual close by when operating machines or tools for reference of safe operation and precautions.

Safety Precautions

Failure to observe the following warnings may cause a potentially hazardous situation, which if not corrected could result in serious injury or death. To prevent the risk of fire, electric shock, and/or personal injury, proper safety guidelines should be followed at all times.

Warning for ALL Machines and Tools

- Always keep the work area free from clutter and potentially dangerous conditions such as hanging power cords, working debris, air hoses, and garbage to prevent accidents from occurring.
- Consider proper working environments for each tool carefully. Do not expose tools to extreme amounts of moisture or direct contact with water or rain. Keep area well lit at all times to prevent hidden dangers and never operate the equipment near flammable liquids or in gaseous or explosive atmospheres.
- Keep all tools and tool accessories away from children and all unauthorized personnel. Serious injury or possible death may result from machines being handled by children.
- Properly store machines and accessories while not in use. They should be kept in a dry, locked-up location out of reach of children or unauthorized personnel.
- Improper or negligent use of tools will cause increased maintenance costs, and the amount of time in which to complete the job. Always let the tool do the work at the rate of which it was designed. Best performance is always achieved by reading and understanding the proper operation of each machine or tool.
- Always wear safety glasses and protective hand and foot wear during or around operating tools. Wear a protective hair covering to contain long hair. Do not wear loose clothing and/or accessories as they may be caught in moving parts and inflict serious injury or possible death.
- Wear respiratory protection when working in an environment where dust particles are generated during operation.
- Do not over-reach or allow yourself to become unstable during tool operation and always maintain a correct posture.
- Use clamps or a vise to secure the work piece tightly and eliminate vibration. Never hold the work piece with your hands, keep both hands on the tool for increased productivity.
- Use the right tool or machine that can complete the job within its specifications. Do not attempt to adapt smaller machines or tools to complete a job designed for heavy-duty equipment. Do not use the tools for other than what they were designed for. There is a right tool for each job, be aware of tool limitations and never overload.
- Make sure to inspect all external screws, nuts, bolts and attached accessories are fastened tightly and secure prior to each use. All moving parts should be free from obstruction and allowed to operate smoothly. Any damaged or missing parts should be repaired or replaced by the sales agent or distributor from which the tool was originally purchased. Do not use machines or tools which cannot be activated or stopped with a power switch or lever.
- Do not use any machine with a damaged, frayed, cut, or deteriorated power cords or air hoses. Always replace at the first sign of damage.
- Always remove all tools required to adjust, add, or remove parts from tools prior to use to prevent tool damage or user injury.
- Always avoid an unexpected start by having all power buttons or levers in the off position prior to attaching to a power or air supply. Never carry tools with your finger on the on/off switch or lever when the power or air supply is attached.
- Do not use the power or air supply lines to move, carry or support the tool during usage or transportation. Do not place the power or air line near a heat source, oil, water, or items with sharp edges.
- Never leave a machine or tool running unattended. Keep a firm grip on the designated areas of the machine or tool until it comes to a complete stop. Always turn the power switch or lever to the off position and disconnect from the power source when not in use.
- Do not disassemble or modify a tool to complete a job other than what it was designed for. This will void any warranty on the equipment and may cause serious personal injury or possible death.
- Maintenance is necessary for all machines and tools. Always maintain blades and cutters properly and replace when edges become damaged or are not sharp enough for safe operation. Follow the instruction manual for lubrication needs and adjustment points if applicable. Check the power and air supply lines periodically and change accordingly to safety regulations. If an extension line is adopted, always make sure that it meets or exceeds tool requirements for amperage or air supply before using and is rated for outdoor usage. Change supply lines whenever they are found to be defective or damaged. Keep the grip and handles dry and clean of grease or oil so that it will not disturb proper operation.
- Switch off and disconnect from power source before servicing equipment or changing accessories.
- Be alert and pay close attention to the work being performed at all times. Do not operate machines or tools when heavily fatigued. Users should be aware of all circumstances surrounding their application.
- Use only recommended parts and accessories as per individual machine or tool operator manuals. Use of improper accessories or attachments may result in serious injury or possible death.
- All repairs and services must be performed by authorized Nitto Kohki dealers or technicians.
- Do not deface or remove any label, warning indicator, or nameplate associated with each machine or tool.

Notice for Electric Tools

- The power source must be limited to the individual tools specifications as stated on the nameplate or instruction manual.
- Make sure that all machine and power tools are properly grounded at all times (excludes double-insulated tools). Always use a GFCI (Ground-Fault-Circuit-Interrupt) to protect the user and surrounding persons from electric shock.
- Be aware of low voltage situations. Improperly gauged extension cords or power cords used or shared with other electrical devices will cause all tools on the line to not run at optimal performance. This condition may result in damage to the machine and/or operator.

Notice for Air Tools

- Air pressure at the inlet of the tool must not exceed 0.59 MPa (6 kgf/cm²).

	Manufacturing	Steel Fabricating	Welding	Metal Casting & Forging	AUTOMOTIVE & SHIP BUILDING	Construction	Page
BORING PORTABLE MAGNETIC BASE AUTOMATIC DRILLING MACHINE ATRA ACE auto feed (WA-3500 / WA-5000)	Speedy, high precision hole drilling	Speedy, high precision hole drilling	—	—	Drilling holes in steel	Drilling holes in shaped steel	3-4
BORING PORTABLE MAGNETIC BASE DRILLING MACHINE ATRA ACE manual feed (WOJ-3200 / WO-3200)	Speedy, high precision hole drilling	Speedy, high precision hole drilling	—	—	Drilling holes in steel	Drilling holes in shaped steel	5
BORING PORTABLE MAGNETIC BASE DRILLING MACHINE ATRA ACE manual feed (AO-5575)	Speedy, high precision hole drilling	Speedy, high precision hole drilling	—	—	Drilling holes in steel	Drilling holes in shaped steel	6
BORING PORTABLE MAGNETIC BASE DRILLING MACHINE ATRA ACE quick auto	Speedy, high precision hole drilling	Speedy, high precision hole drilling	—	—	Drilling holes in steel	Drilling holes in shaped steel	7
BORING PORTABLE MAGNETIC BASE DRILLING MACHINE ATRA ACE manual feed	Speedy, high precision hole drilling	Speedy, high precision hole drilling	—	—	Drilling holes in steel	Drilling holes in shaped steel	8
BORING PORTABLE MAGNETIC DRILL STAND ATRA MASTER	Precision boring of flanges	Drilling	Initial boring for sheet cutting by welder	Home boring for jig attachment	Various boring	Bring of shaped steel, drilling at elevated site	8
BORING ANNULAR CUTTERS BROACH CUTTERS & BROACH HOLDERS	Drilling of large and small diameter holes in steel	Drilling holes in steel	—	—	Drilling holes	Drilling of large and small diameter holes in steel	9-10
PUNCHING PORTABLE DOUBLE-ACTING HYDRAULIC PUNCHER SELFER ACE HS SERIES & HYDRAULIC PUMP	Hole punching on steel plates	Punching bolt holes on steel plates	—	—	Punching holes on ship frameworks	On-site punching holes on shaped steels	11
PUNCHING PORTABLE SINGLE-ACTING HYDRAULIC PUNCHER SELFER HA SERIES & HYDRAULIC PUMP	Hole punching on steel plates	Punching bolt holes on steel plates	—	—	Punching holes on ship frameworks	On-site punching holes on shaped steels	12
PUNCHING ELECTRICALLY OPERATED HYDRAULIC PUNCHER HANDY SELFER AND PUNCHES & DIES FOR SELFER	Speedy, easy hole punching on steel sheets	Punching holes on angles and channels	—	—	—	On-site small hole punching	13-14
CHAMFERING PORTABLE CHAMFERING TOOLS BEVELER HAND BEVELER	Chamfering of large workpieces	Chamfering of steel plates	—	—	—	Chamfering of columns	15
CHAMFERING PORTABLE CHAMFERING TOOLS BEVELER MINI BEVELER	Chamfering of large workpieces	Chamfering of steel plates	Surface chamfering of pre-welded shaped steel parts	Chamfering of cast molds	—	—	15-16
CHAMFERING PORTABLE CHAMFERING TOOLS CIRCUIT BEVELER	Chamfering of dies and machine	—	—	Chamfering of steel plate	—	Chamfering of steel plate	15-16
Power Tools, delvo, Spring Balancer, Linear Motor Driven Free Piston System							17
CUPLA Series / Mini Cupla Super							18

ATRA ACE auto Model **WA-3500**

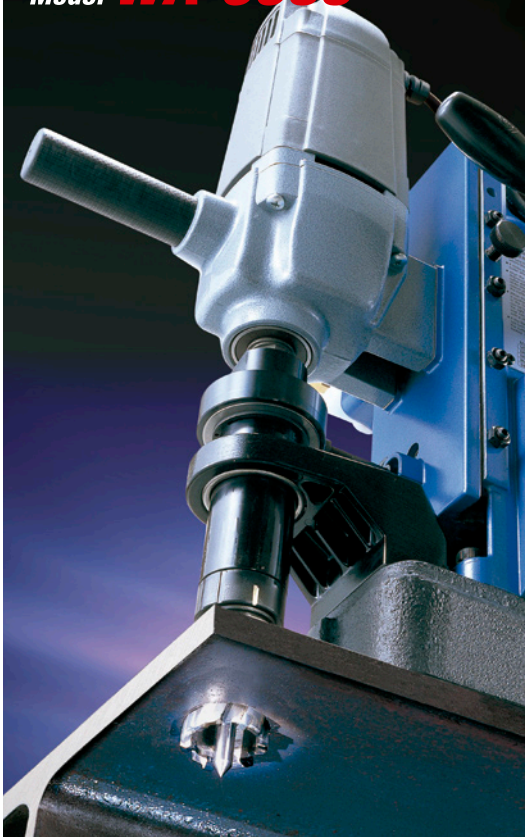

ATRA ACE auto Model **WA-5000**



High-performance mechanism & high-tech components

One-touch cutter replacement

Replacement is quick and easy with our unique push fit self-centering cutter system.

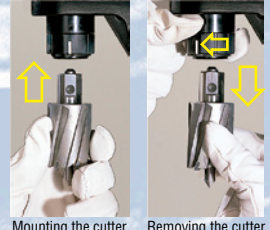

Coolant into the Heart of the cut

Coolant is fed directly to the inside of the cut. The coolant system also features an auto shut-off.

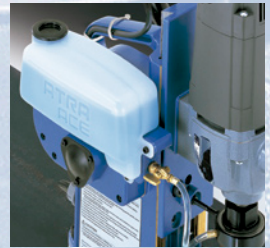

Fail-Safe Protection

Built-in motion sensor

If any lateral movement or excess vibration is detected, both the drill and the feed motor stop instantly. Nitto Kohki is the first company to incorporate this feature into magnetic base drills.

Fail-safe restart

The drill will not re-start even if power is re-supplied after accidental shutdown. Drilling can only be continued after turning on the drill switch.

Magnet open-circuit sensor

The drill will not start until the magnetic field is active.

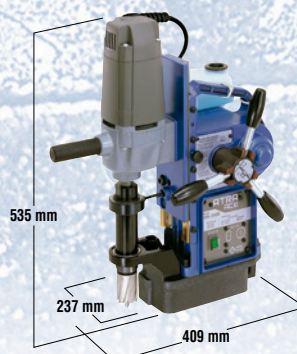

Model **WA-3500**

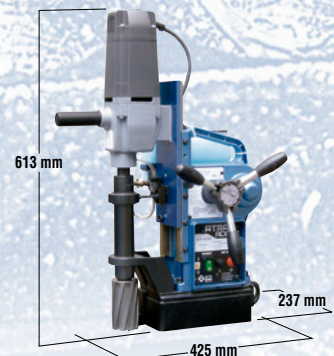

Model **WA-5000**

New drill control prevents cutters from breaking

Slow start mechanism

The feed speed is reduced for the first few seconds after boring begins to ensure a smooth cut through the mill scale.

Auto-feed

Automatic control & feed are activated by simply pushing the rod handle to engage the gears.

Load sensor

The dual sensing system responds to both drilling and feeding forces on the cutter for the optimum cutting condition.

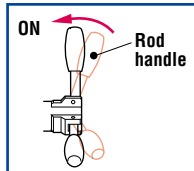

Variable speed

The feed speed is continuously monitored and updated proportionally to the load on the cutter.

Cycle stop

After the cut has finished, a detector responds to the reduction in load and both the drill and the feed motor automatically stop.

Overload stop

When an excessive load is applied to the cutter, both the drill and the feed motor will stop automatically to prevent the cutter from breaking.

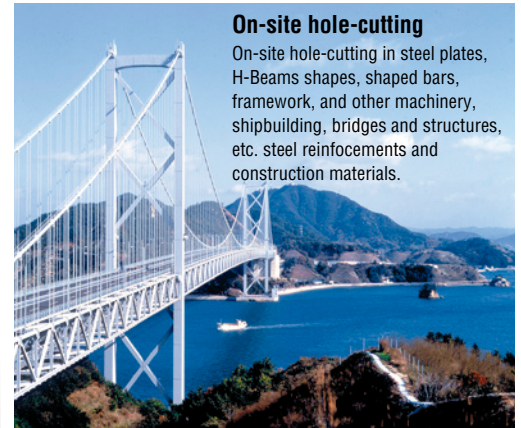
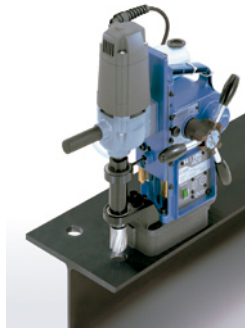

On-site hole-cutting

On-site hole-cutting in steel plates, H-Beams shapes, shaped bars, framework, and other machinery, shipbuilding, bridges and structures, etc. steel reinforcements and construction materials.



Specifications

Model		WA-3500		WA-5000			
Power Source (Single Phase)		110 - 120 V AC, 50/60 Hz	220 - 240 V AC, 50/60 Hz	110 - 120 V AC, 50/60 Hz	220 - 240 V AC, 50/60 Hz		
Electric Drill	Rated Power Consumption	W		1,100			
	Rated Current	A	10.2	5.1	10.8	5.4	
	No Load Speed	min ⁻¹ (rpm)	950		350 / 650		
Magnet Power Consumption		W		34			
Hole-cutting Capacity		Cutter	Hole Diameter	Plate Thickness	Hole Diameter	Plate Thickness	
One-touch type JETBROACH 25L		—	—	—	12 to 17 mm	9 to 25 mm	
One-touch type JETBROACH 35L		—	17.5 to 35 mm	9 to 35 mm	17.5 to 40 mm	9 to 35 mm	
One-touch type JETBROACH 50L		—	17.5 to 35 mm	9 to 35 mm	12 to 50 mm	9 to 50 mm	
One-touch type JETBROACH 75L		—	—	—	17.5 to 50 mm	9 to 75 mm	
One-touch type HI-BROACH 25L		—	14 to 35 mm	9 to 25 mm	14 to 50 mm	9 to 25 mm	
One-touch type HI-BROACH 50L		—	—	—	14 to 50 mm	9 to 50 mm	
Magnet Holding Power		N (kgf)	7,056 (720)		9,800 (1,000)		
Magnet Dimensions		mm	92 x 216		101 x 201		
Mass (Weight)		kg	20		23		
Standard Accessories		<ul style="list-style-type: none"> • Pilot Pin 08035 A2 : 1 pc. • Chain Ass'y : 1 set • Side Handle Ass'y : 1 set • 3 mm Hex Socket Screw Key : 1 pc. • 8 x 10 mm Spanner : 1 pc. • Cutting Oil 0.5 L : 1 can • Plastic Case : 1 pc. 				<ul style="list-style-type: none"> • Pilot Pin 08050 A3 : 1 pc. • Chain Ass'y : 1 set • Side Handle Ass'y : 1 set • 3 mm / 4 mm Hex Socket Screw Key : each 1 pc. • 8 x 10 mm Spanner : 1 pc. • Cutting Oil 0.5 L : 1 can • Plastic Case : 1 pc. • Guard Ass'y : 1 set 	
Optional Accessories							
		<p>Always use genuine Nitto Kohki cutters & coolant.</p>				<p>Always use genuine Nitto Kohki cutters & coolant.</p>	

Designed to use Jetbroach Carbide Tipped Annular Cutters



Reversible Feed Handles

Feed handles can be positioned on the right or left hand side for ease of drilling and mounting in confined spaces.

Optional Jet Oiling System

Optional jet oiling system for use with all drilling applications and types of cutters to extend cutter life and increase hole output.



Optional One-Touch Adapter

Optional one-touch adapter allows the use of up to 13 mm twist drills to be used in the original arbor.



Optional Chip Breaker

Optional chip breaker helps prevent the cutter from plugging the hole with chip debris, causing some false overloads and cutter life loss.



Body Height Adjustment

Loosening the pillar clamp allows the complete frame to be lifted up to a maximum of 60 mm for specific drilling. The use of Hi-Broach cutters require the frame to be at the lowest position, while twist bit drilling required the appropriate amount of elevation to be adjusted for safe operation. The pillar clamp is required to be tightened before safe drilling may take place. Note: Always engage the magnet before adjusting the body height.

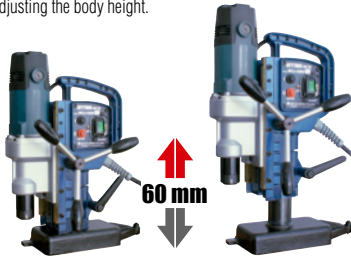

Specifications

Model		WOJ-3200		
Power Source (Single Phase)		220 - 240 V AC, 50/60 Hz		
Electric Drill	Rated Power Consumption W	950		
	Rated Current A	4.3		
	No Load Speed min ⁻¹ (rpm)	870		
Magnet Power Consumption W		70		
Hole-cutting Capacity		Cutter	Hole Diameter	Plate Thickness
One-touch type JETBROACH		12 to 32 mm	9 to 50 mm	
Magnet Holding Power kN (kgf)		9 (918)		
Magnet Dimensions mm		99 x 177		
Mass (Weight) kg		13		
Standard Accessories		<ul style="list-style-type: none"> • Pilot Pin 08050 : 1 pc. • 3 mm Hex Socket Screw Key : 1 pc. • 6 mm Hex Socket Screw Key : 1 pc. • 8 x 10 mm Spanner : 1 pc. • Safety Strap : 1 pc. • Sub Handle : 1 pc. • Guard Assy : 1 set 		

Designed to use High Speed Steel Annular Cutters

ATRA ACE Manual feed Model WO-3200

Newly developed Over-Load Shutdown, Magnet Open-Circuit Sensor, and Fail-Safe Restart technology formerly only found on high-end Nitto Automatics are incorporated on the machine. (Smart-Stop / Rapid-Restart feature is not included.)



Specifications

Model		WO-3200		
Power Source (Single Phase)		220 - 240 V AC, 50/60 Hz		
Electric Drill	Rated Power Consumption W	950		
	Rated Current A	4.3		
	No Load Speed min ⁻¹ (rpm)	530		
Magnet Power Consumption W		70		
Hole-cutting Capacity		Cutter	Hole Diameter	Plate Thickness
One-touch type HI-BROACH		12 to 32 mm	9 to 50 mm	
Magnet Holding Power kN (kgf)		9 (918)		
Magnet Dimensions mm		99 x 177		
Mass (Weight) kg		13		
Standard Accessories		<ul style="list-style-type: none"> • Pilot Pin 08050 : 1 pc. • 3 mm Hex Socket Screw Key : 1 pc. • 8 x 10 mm Spanner : 1 pc. • Side Handle Assy's : 1 set • Safety Strap : 1 pc. • Guard Assy : 1 set 		

The world's first manual feed with "Smart-Stop / Rapid-Restart" technology for WOJ-3200 / AO-5575

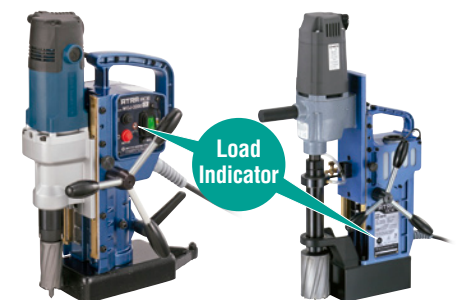

Model WOJ-3200

Model AO-5575

This new feature is a breakthrough in the Manual drill industry. Formerly only found on high end Nitto Kohki Automatic drills, this technology displays the current drill status via the LED Load Indicator. Customers will experience a cutting edge drill management system designed solely around saving time and money in replacement parts and cutters in addition to reducing user fatigue and downtime.

Designed to use Jetbroach and Hi-broach Annular Cutters



Coolant Valve
Adjustable coolant flow delivered to the center of the cutter.



Optional Chip Breaker
This chip breaker prevents the cutter from becoming jammed with metal shavings.



Built-in coolant tank prevents damage



Reversible feed handle

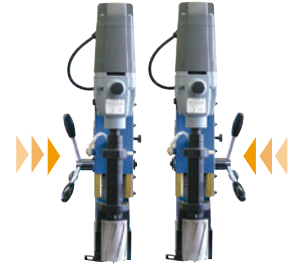

Speed selection (Change gear)

Low Speed



Hi Speed



Specifications

Model		AO-5575	
Power Source (Single Phase)		220 - 240 V AC, 50/60 Hz	
Electric Drill	Rated Power Consumption	W	1,150
	Rated Current	A	5.4
	No Load Speed	min⁻¹ (rpm)	350 / 650
Magnet Power Consumption		W	50
Hole-cutting Capacity		Cutter	Hole Diameter Plate Thickness
One-touch type JETBROACH			12 to 55 mm 9 to 75 mm
One-touch type HI-BROACH			12 to 50 mm 9 to 50 mm
Magnet Holding Power		kN (kgf)	10 (1,020)
Magnet Dimensions		mm	86 x 170
Mass (Weight)		kg	18
Standard Accessories		<ul style="list-style-type: none"> Pilot Pin 08050 A3 : 1 pc. 3 mm Hex Socket Screw Key : 1 pc. Chain Ass'y : 1 set 5 mm Hex Socket Screw Key : 1 pc. Side Handle Ass'y : 1 set 8 x 10 mm Spanner : 1 pc. Cutting Oil 0.5 L : 1 can Guard Ass'y : 1 set 	
Optional Accessories		<ul style="list-style-type: none"> JETBROACH One-touch Type 25 mm, 35 mm, 50 mm, 75 mm HI-BROACH One-touch Type 25 mm, 50 mm TB01507 Cutting Oil 2 L per can 	

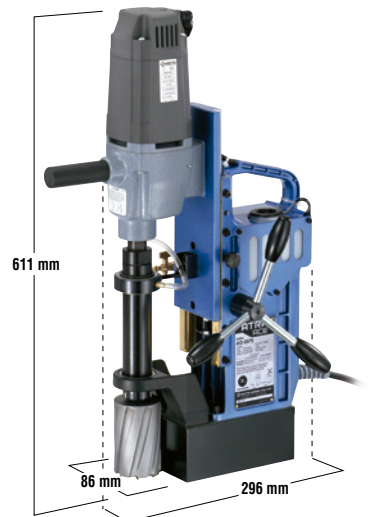

Model AO-5575

Load detector with "Smart-Stop/Rapid-Restart" technology

As the drilling load increases, the load indicator will change in color from green to orange to red. In addition, if excessive feeding force is applied, the load indicator will rapidly blink red and the rotation of the drill motor will slow down and temporarily stop. If the load is released while the load indicator is blinking red, the drill motor will resume its rotation.

LED load indicator

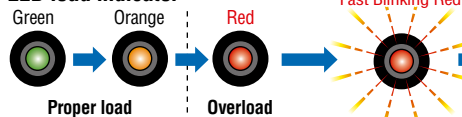

Continued overload

Drill motor will not turn on

Slow Blinking Green

Drill motor shuts off

"Rapid-Start" resumes drilling operation

Resume proper load

Safety mode

Magnet malfunction



One-touch cutter replacement

Our original self-centering tool-less chuck is quick and easy to change cutters with little downtime.

(WOJ-3200)

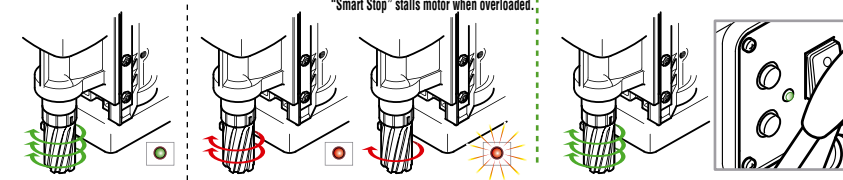
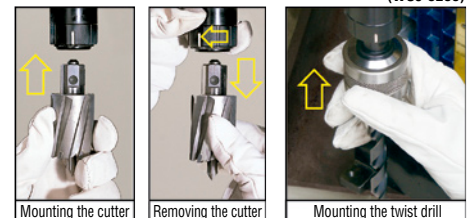

Design to use Jetbroach and Hi-broach Annular Cutters

ATRA ACE quick auto



QUICK AUTO Drills increase productivity and reduce hole drilling cost.

Proven Automatic Tecnology

- Self feeding
- Limit Switch
- Automatic step feed
- Load detection
- Automatic return
- Emergency stop

Automatic return

Once drilling is completed and the slug is ejected from the hole, the cutting bit is quickly retracted. This quick drill motor retraction allows the user to move onto the next hole more quickly.



Automatic Step Feed (QA-6500)

Step feed feature optimizes cutter penetration.

Side Slip Detection Function

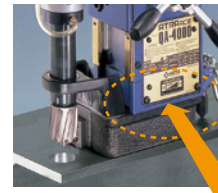

This feature automatically stops the drill from operating when sudden lateral force is applied to the machine.

Built-in motion detection sensor

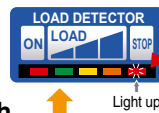

Self feeding & Load detection

The feeding is controlled by an onboard microcomputer. The feed rate begins slowly and then increases to the appropriate speed for the cutter size and load condition. The load detector clearly shows the amount of resistance on the cutter at anytime.

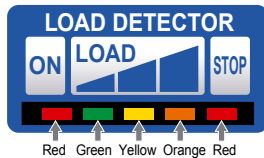

Limit Switch

When the drill has reached to the top of its stroke, a limit switch stops the drill motor. There is also a limit switch at the bottom of drill stroke.

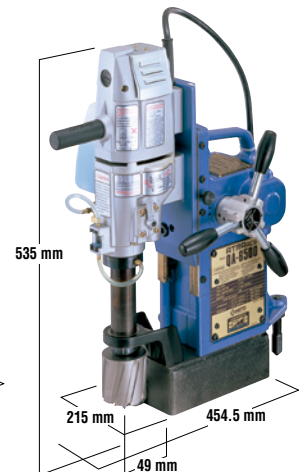

Specifications

Model	QA-4000		QA-6500		
Power Source (Single Phase)	115 V AC, 50/60 Hz		220 - 240 V AC, 50/60 Hz		
Electric Drill	Rated Power Consumption	W	680	1,010	
	Rated Current	A	6.1	3.0	
	No Load Speed	min ⁻¹ (rpm)	750	400 / 750	
Magnet Power Consumption	W	50	75		
Hole-cutting Capacity	Cutter	Hole Diameter	Plate Thickness	Hole Diameter	Plate Thickness
	One-touch type JETBROACH 35L	17.5 to 40 mm	9 to 35 mm	17.5 to 40 mm	9 to 35 mm
One-touch type JETBROACH 50L	—	—	17.5 to 65 mm	9 to 50 mm	
One-touch type HI-BROACH 25L	14 to 15 mm	9 to 12 mm	18 to 35 mm	9 to 25 mm	
	16 to 18 mm	9 to 25 mm	—	—	
Magnet Holding Power	N (kgf)	6,664 (680)	9,800 (1,000)		
Magnet Dimensions	mm	82 x 172	100 x 200		
Mass (Weight)	kg	18.5	26		
Standard Accessories	<ul style="list-style-type: none"> • Pilot Pin 08035 A2 : 1 pc. • Chain : 1 pc. • 3 mm Hex Socket Screw Key : 1 pc. • 4 mm Hex Socket Screw Key : 1 pc. • 8 x 10 mm Spanner : 1 pc. • Cutting Oil 0.5 L : 1 can • Tool box : 1 pc. • Side Handle : 1 pc. • Oil Tank Ass'y : 1 set. 		<ul style="list-style-type: none"> • Pilot Pin 08050 A3 : 1 pc. • Chain : 1 pc. • 3 mm Hex Socket Screw Key : 1 pc. • 4 mm Hex Socket Screw Key : 1 pc. • 8 x 10 mm Spanner : 1 pc. • Cutting Oil 0.5 L : 1 can • Tool box : 1 pc. • Chip Stopper : 1 pc. • Side Handle : 1 pc. • Oil Tank Ass'y : 1 set. 		

One-touch Cutter Replacement!

One-Touch arbor system requires no tools for cutter installation and removal.

Improved Feature Bearing Bracket

Precision bearing bracket aligns cutters precisely, which increases cutter life.



Chip Breaker

Chip breaker prevents swarf and chip nesting.

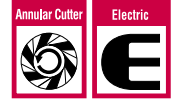
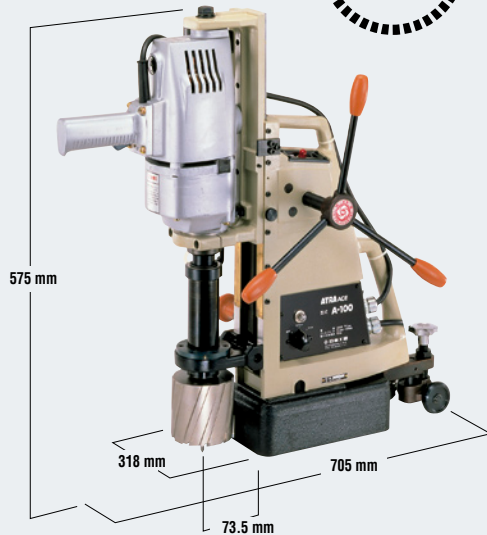

Designed to use Jetbroach Carbide Tipped Annular Cutters

**ATRA ACE**
manual feedModel **A-100**

Side-lock Type Cutter

Max. Hole-cutting Capacity : 100 mm dia.
Max. Plate Thickness : 75 mm

**The largest capacity drilling machine
in the Nitto Kohki line.**

Specifications

Model		A-100	
Power Source (Single Phase)		220 - 240 V AC, 50/60 Hz	
Electric Drill	Rated Power Consumption	W	1,600
	Rated Current	A	7.4
	No Load Speed	min ⁻¹ (rpm)	330
Magnet Power Consumption		W	80
Hole-cutting Capacity		Cutter	Hole Diameter Plate Thickness
Side-Lock type JETBROACH 75L			50 to 100 mm 13 to 75 mm
Magnet Holding Power		N (kgf)	17,640 (1,800)
Magnet Dimensions		mm	130 x 256
Mass (Weight)		kg	50
Standard Accessories		<ul style="list-style-type: none"> • Pilot Pin 12075 : 1 pc. • Chain : 1 pc • 2 mm / 2.5 mm / 3 mm / 4 mm / 5 mm / 6 mm / 8 mm Hex Socket Screw Key : each 1 pc. • 7 x 8 mm Spanner : 1 pc. • Cutting Oil 0.5 L : 1 can • Tool box : 1 pc. • Oil Cap Assy : 1 set. • Rod Handle : 3 pcs. 	

The magnet bases of ATRA MASTER hold the drills perpendicular to steel plates even on non horizontal places.

**ATRA MASTER**
Model **M-100**

Drilling Capacity : 10 mm
Power Source (Single Phase) :
220 - 240 V AC, 50/60 Hz
Mass (weight) : 6.2 kg

ATRA MASTER
Model **M-130A**

Drilling Capacity : 13 mm
Power Source (Single Phase) :
220 - 240 V AC, 50/60 Hz
Mass (weight) : 16 kg

ATRA MASTER
Model **M-250B**

Drilling Capacity : 25 mm
Power Source (Single Phase) :
220 - 240 V AC, 50/60 Hz
Mass (weight) : 25.5 kg

ATRA MASTER
Model **M-320**

Drilling Capacity : 32 mm
Power Source (Single Phase) :
220 - 240 V AC, 50/60 Hz
Mass (weight) : 29 kg

N.B. : The electric drill and drill mount fixture do not come with ATRA MASTERS.

JETBROACH CUTTERS & HI-BROACH CUTTERS

BROACH CUTTERS are far better than twist drills:

- No dead point
- Peripheral cutting
- Blade cutting resistance reduced by 50 %
- Available diameter size: 12 - 100 mm

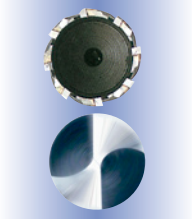



Test Drilling is very often the only way to determine the machinability of difficult materials. Use a small size cutter wherever possible in order to minimize trial costs.







BROACH HOLDERS

Industrial cutters for faster and better finished holes.

- The Spring-loaded pilot pin picks up the hole location quickly, and ejects the slug automatically at the end of cut
- Available with No. 2 - 4 Morse taper shanks
- Oil cup complete Ass'y (PN TB00350) is available as an optional attachment which provides continuous and adjustable cutting oil flow to the cutting area

Morse Taper No.	Model	Cutter	Cutter Diameter	Pilot Pin	Accessory
M.T.No.2	 163 mm	HBO-25L	12 - 17 dia.	06025 (PN TK01167)	Optional
			17.5 - 35 dia.	08025 (PN TJ12696)	
M.T.No.3	 182 mm	HBO-25L	12 - 17 dia.	06025 (PN TK01167)	Optional
			17.5 - 52 dia.	08025 (PN TJ12696)	
		HBO-50L	12 - 18 dia.	06050 (PN TK01166)	Optional
			19 - 52 dia.	0850 (PN TK00802) 08050 (PN TJ16019)	
		JBO-35L	17.5 - 40 dia.	08035 (PN TJ15859)	Standard
		JBO-50L	17.5 - 65 dia.	08050 (PN TJ16019)	Optional
JBO-50L(W)	18 - 35 dia.	08050 (PN TJ16019)	Optional		
M.T.No.4	 248 mm	JBS-75L	50 - 100 dia.	12075 (PN TA9A207)	Standard

HI-BROACH One-touch Type			WO-3200	AO-5575	IWA-3500	IWA-5000	OA-4000	OA-6500	HI-BROACH One-touch Type			WO-3200	AO-5575	IWA-5000
mm dia.	Depth	PN							mm dia.	Depth	PN			
12	25 mm	TK00698	•	•					12	50 mm	TK00721	•	•	
13		TK00699	•	•					13		TK00722	•	•	
14		TK00700	•	•	•	•	•		14		TK00723	•	•	•
15		TK00701	•	•	•	•	•		15		TK00724	•	•	•
16		TK00702	•	•	•	•	•		16		TK00725	•	•	•
17		TK00703	•	•	•	•	•		17		TK00726	•	•	•
17.5		TK00335	•	•	•	•	•		18		TK00727	•	•	•
18		TK00336	•	•	•	•	•		19		TK00728	•	•	•
19		TK00337	•	•	•	•	•		20		TK00729	•	•	•
19.5		TK00338	•	•	•	•	•		21		TK00730	•	•	•
20		TK00339	•	•	•	•	•		22		TK00731	•	•	•
21		TK00340	•	•	•	•	•		23		TK00732	•	•	•
21.5		TK00341	•	•	•	•	•		24		TK00733	•	•	•
22		TK00342	•	•	•	•	•		25		TK00734	•	•	•
22.5		TK00343	•	•	•	•	•		26		TK00735	•	•	•
23		TK00344	•	•	•	•	•		27		TK00736	•	•	•
23.5		TK00345	•	•	•	•	•		28		TK00737	•	•	•
24		TK00346	•	•	•	•	•		29		TK00738	•	•	•
24.5		TK00347	•	•	•	•	•		30		TK00739	•	•	•
25		TK00348	•	•	•	•	•		31		TK00740	•	•	•
26		TK00349	•	•	•	•	•		32		TK00741	•	•	•
27		TK00351	•	•	•	•	•		33		TK00742	•	•	•
28		TK00352	•	•	•	•	•		34		TK00743	•	•	•
29		TK00353	•	•	•	•	•		35		TK00744	•	•	•
30		TK00354	•	•	•	•	•		36		TK00745	•	•	•
31	TK00355	•	•	•	•	•		37	TK00746	•	•	•		
32	TK00356	•	•	•	•	•		38	TK00747	•	•	•		
33	TK00357	•	•	•	•	•		39	TK00748	•	•	•		
34	TK00359	•	•	•	•	•		40	TK00749	•	•	•		
35	TK00361	•	•	•	•	•		41	TK00750	•	•	•		
36	TK00704	•	•	•	•	•		42	TK00751	•	•	•		
37	TK00705	•	•	•	•	•		43	TK00752	•	•	•		
38	TK00706	•	•	•	•	•		44	TK00753	•	•	•		
39	TK00707	•	•	•	•	•		45	TK00754	•	•	•		
40	TK00708	•	•	•	•	•		46	TK00755	•	•	•		
41	TK00709	•	•	•	•	•		47	TK00756	•	•	•		
42	TK00710	•	•	•	•	•		48	TK00757	•	•	•		
43	TK00711	•	•	•	•	•		49	TK00758	•	•	•		
44	TK00712	•	•	•	•	•		50	TK00759	•	•	•		
45	TK00713	•	•	•	•	•		51	TK00760	•	•	•		
46	TK00714	•	•	•	•	•		52	TK00761	•	•	•		
47	TK00715	•	•	•	•	•								
48	TK00716	•	•	•	•	•								
49	TK00717	•	•	•	•	•								
50	TK00718	•	•	•	•	•								
51	TK00719	•	•	•	•	•								
52	TK00720	•	•	•	•	•								

		HI-BROACH One-touch Type / 25L	HI-BROACH One-touch Type / 50L	JETBROACH One-touch Type / 25,35,50L	JETBROACH One-touch Type / 50L(W)	JETBROACH One-touch Type / 75L	JETBROACH Side lock Type / 75L
							
Hole-cutting Capacity	Hole Diameter mm	25L : 12 - 52 dia.	—	25L : 12 - 17 dia.	—	—	—
		—	—	35L : 17.5 - 40 dia.	—	—	—
		—	50L : 12 - 52 dia.	50L : 12 - 65 dia.	50L(W) : 18,22,24 - 26.5, 28,32, and 35 dia.	75L : 17.5 - 55 dia.	75L : 50 - 100 dia.
	Plate Thickness mm	25L : 25	—	25L : 25	—	—	—
		—	—	35L : 35	—	—	—
		—	50L : 50	50L : 50	50L(W) : 50	—	—
		—	—	—	—	75L : 75	75L : 75
Feed Speed mm/rev		0.02 - 0.1					
Circumferential Speed m/min		15 - 35 (mild steel)			35 - 50 (mild steel)		

JETBROACH One-touch Type			WOJ-3200	AO-5575	WA-3500	WA-5000	OA-4000	OA-6500
mm dia.	Depth	PN						
12	25 mm	TK01148	●	●				
13		TK01149	●	●				
14		TK01150	●	●				
15		TK01151	●	●				
16		TK01152	●	●				
17		TK01153	●	●				
17.5		35 mm	TK00301	●	●	●	●	●
18	TK00302		●	●	●	●	●	●
19	TK00304		●	●	●	●	●	●
19.5	TK00305		●	●	●	●	●	●
20	TK00306		●	●	●	●	●	●
20.5	TK00307		●	●	●	●	●	●
21	TK00308		●	●	●	●	●	●
21.5	TK00309		●	●	●	●	●	●
22	TK00310		●	●	●	●	●	●
22.5	TK00311		●	●	●	●	●	●
23	TK00312		●	●	●	●	●	●
23.5	TK00313		●	●	●	●	●	●
24	TK00314		●	●	●	●	●	●
24.5	TK00315		●	●	●	●	●	●
25	TK00316		●	●	●	●	●	●
26	TK00317		●	●	●	●	●	●
26.5	TK00318		●	●	●	●	●	●
27	TK00319		●	●	●	●	●	●
28	TK00320		●	●	●	●	●	●
29	TK00321		●	●	●	●	●	●
30	TK00322		●	●	●	●	●	●
31	TK00323		●	●	●	●	●	●
32	TK00324		●	●	●	●	●	●
33	TK00325		●	●	●	●	●	●
34	TK00326		●	●	●	●	●	●
35	TK00328		●	●	●	●	●	●
36	TK00602		●	●	●	●	●	●
37	TK00603		●	●	●	●	●	●
38	TK00604		●	●	●	●	●	●
39	TK00605		●	●	●	●	●	●
40	TK00606		●	●	●	●	●	●

JETBROACH One-touch Type			WOJ-3200	AO-5575
50L for stacked two (=W) plates.				
mm dia.	Depth	PN		
18	50 mm	TK01068	●	●
22		TK00622	●	●
24		TK00623	●	●
24.5		TK00631	●	●
25		TK00624	●	●
26		TK00625	●	●
26.5		TK00632	●	●
28		TK00626	●	●
32		TK00627	●	●
35		TK00628	●	●

JETBROACH One-touch Type			WOJ-3200	AO-5575	WA-3500	WA-5000	OA-6500
mm dia.	Depth	PN					
12	50 mm	TK01154	●	●			
13		TK01155	●	●			
14		TK01156	●	●			
15		TK01157	●	●			
16		TK01158	●	●			
17		TK01159	●	●			
17.5		TK00380	●	●	●	●	●
18		TK00381	●	●	●	●	●
19		TK00382	●	●	●	●	●
19.5		TK00383	●	●	●	●	●
20		TK00384	●	●	●	●	●
20.5		TK00385	●	●	●	●	●
21		TK00386	●	●	●	●	●
21.5		TK00387	●	●	●	●	●
22		TK00388	●	●	●	●	●
22.5		TK00389	●	●	●	●	●
23		TK00390	●	●	●	●	●
23.5		TK00391	●	●	●	●	●
24		TK00392	●	●	●	●	●
24.5		TK00393	●	●	●	●	●
25		TK00394	●	●	●	●	●
26		TK00395	●	●	●	●	●
26.5		TK00396	●	●	●	●	●
27		TK00397	●	●	●	●	●
28		TK00398	●	●	●	●	●
29		TK00399	●	●	●	●	●
30		TK00400	●	●	●	●	●
31		TK00401	●	●	●	●	●
32		TK00402	●	●	●	●	●
33		TK00403	●	●	●	●	●
34		TK00404	●	●	●	●	●
35		TK00405	●	●	●	●	●
36		TK00406	●	●	●	●	●
37		TK00407	●	●	●	●	●
38		TK00408	●	●	●	●	●
39		TK00409	●	●	●	●	●
40		TK00410	●	●	●	●	●
41		TK00411	●	●	●	●	●
42		TK00412	●	●	●	●	●
43		TK00413	●	●	●	●	●
44		TK00414	●	●	●	●	●
45		TK00415	●	●	●	●	●
46	TK00416	●	●	●	●	●	
47	TK00417	●	●	●	●	●	
48	TK00418	●	●	●	●	●	
49	TK00419	●	●	●	●	●	
50	TK00420	●	●	●	●	●	
51	TK00442	●	●	●	●	●	
52	TK00443	●	●	●	●	●	
53	TK00444	●	●	●	●	●	
54	TK00445	●	●	●	●	●	
55	TK00446	●	●	●	●	●	
56	TK00447	●	●	●	●	●	
57	TK00448	●	●	●	●	●	
58	TK00449	●	●	●	●	●	
59	TK00450	●	●	●	●	●	
60	TK00451	●	●	●	●	●	
61	TK00607	●	●	●	●	●	
62	TK00608	●	●	●	●	●	
63	TK00609	●	●	●	●	●	
64	TK00610	●	●	●	●	●	
65	TK00611	●	●	●	●	●	

JETBROACH One-touch Type			AO-5575	WA-5000
mm dia.	Depth	PN		
17.5	75 mm	TK01036	●	●
18		TK01003	●	●
19		TK01004	●	●
20		TK01005	●	●
21		TK01006	●	●
22		TK01007	●	●
23		TK01008	●	●
24		TK01009	●	●
25		TK01010	●	●
26		TK01011	●	●
27		TK01012	●	●
28		TK01013	●	●
29		TK01014	●	●
30		TK01015	●	●
31		TK01016	●	●
32		TK01017	●	●
33		TK01018	●	●
34		TK01019	●	●
35		TK01020	●	●
36		TK01021	●	●
37		TK01022	●	●
38		TK01023	●	●
39		TK01024	●	●
40		TK01025	●	●
41		TK01026	●	●
42		TK01027	●	●
43		TK01028	●	●
44		TK01029	●	●
45		TK01030	●	●
46		TK01031	●	●
47		TK01032	●	●
48		TK01033	●	●
49		TK01034	●	●
50		TK01035	●	●
51		TK01112	●	●
52		TK01113	●	●
53		TK01114	●	●
54		TK01115	●	●
55	TK01116	●	●	

JETBROACH Side-lock Type			
mm dia.	Depth	PN	A-100
50	75 mm	TJ17709	●
51		TJ16651	●
52		TJ16652	●
53		TJ16653	●
54		TJ16654	●
55		TJ16655	●
56		TJ16656	●
57		TJ16657	●
58		TJ16658	●
59		TJ16659	●
60		TJ16660	●
61		TJ16661	●
62		TJ16662	●
63		TJ16663	●
64		TJ16664	●
65		TJ16665	●
66		TJ16666	●
67		TJ16667	●
68		TJ16668	●
69		TJ16669	●
70		TJ16670	●
71		TJ16671	●
72		TJ16672	●
73		TJ16673	●
74		TJ16674	●
75		TJ16675	●
76		TJ16676	●
77		TJ16677	●
78		TJ16678	●
79		TJ16679	●
80		TJ16680	●
81		TJ16681	●
82		TJ16682	●
83		TJ16683	●
84		TJ16684	●
85		TJ16685	●
86		TJ16686	●
87		TJ16687	●
88		TJ16688	●
89		TJ16689	●
90		TJ16690	●
91		TJ16691	●
92		TJ16692	●
93		TJ16693	●
94		TJ16694	●
95		TJ16695	●
96		TJ16696	●
97		TJ16697	●
98		TJ16698	●
99		TJ16699	●
100	TJ16700	●	

Combination of Pilot Pins & Broach Cutters

Pilot Pin	HI-BROACH Cutters
06025 PN: TK01167 	HBO 12 - 17 dia. Depth 25 mm
08025 PN: TJ12696 	HBO 17.5 - 52 dia. Depth 25 mm
06050 PN: TK01166 	HBO 12 - 18 dia. Depth 50 mm
0850 PN: TK00802 	HBO 19 - 52 dia. Depth 50 mm
08050 PN: TJ16019 	

Pilot Pin	JETBROACH Cutters
06025 PN: TK01167 	JBO 12 - 17 dia. Depth 25 mm
08035 PN: TJ15859 	JBO 17.5 - 40 dia. Depth 35 mm
06050 PN: TK01166 	JBO 12 - 17 dia. Depth 50 mm

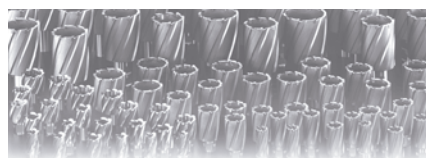

Pilot Pin	JETBROACH Cutters
08050 PN: TJ16019 	JBO 17.5 - 65 dia. Depth 50 mm
	JBO(W) 18 - 35 dia. Depth 50 mm for stacked two (=W) plates.
08075 PN: TJ17436 	JBO 17.5 - 55 dia. Depth 75 mm

Pilot Pin	JETBROACH Cutters
12075 PN: TA9A207 	JBS 50 - 100 dia. Depth 75 mm

**New design adopted for punching stainless steel.
Inching function (manual operation) is available.**

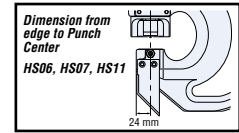

SELFER ACE
Model **HS06-1322**

423 mm 323 mm

- Max. Punching Thickness : 13 mm
- Max. Punching Diameter : 22 mm
- Max. Throat Depth : 60 mm

SELFER ACE
Model **HS07-1624**

430.5 mm 363 mm

- Max. Punching Thickness : 16 mm
- Max. Punching Diameter : 24 mm
- Max. Throat Depth : 70 mm

SELFER ACE
Model **HS11-1624**

462.5 mm 385 mm

- Max. Punching Thickness : 16 mm
- Max. Punching Diameter : 24 mm
- Max. Throat Depth : 110 mm

Specifications

In case of mild steel maximum punching thickness must be decided based on the equation of 0.8 x punching diameter. For details see the instruction manual.

Model	HS06-1322		HS07-1624		HS11-1624			
Max. Throat Depth	mm 60		70		110			
Punching Capacity	for Mild Steel	for Stainless Steel	for Mild Steel	for Stainless Steel	for Mild Steel	for Stainless Steel		
Max. Punching Thickness	mm 13	6	16	6	16	6		
Max. Punching Diameter	mm 22	22	24	24	24	24		
Hole Making Time	Punching Time 7.9 sec.		Punching Time 11.8 sec.		Punching Time 11.8 sec.			
	Returning Time 3.4 sec.		Returning Time 5.7 sec.		Returning Time 5.7 sec.			
Allowable Max. Pressure	MPa (kgf/cm ²) 68.65 (700)		68.65 (700)		68.65 (700)			
Max. Output	kN (tf) 367 (37)		464 (47)		464 (47)			
Ram Stroke	mm 21		25		25			
Mass (Weight)	kg 20.5		25.5		30			
Standard Accessories	<ul style="list-style-type: none"> Hose Kit Ass'y : 1 set Hose Cord Ass'y : 1 set 4 mm / 5 mm Hex. Socket Screw Key : Each 1 pc. Spanner : 1 pc. Spanner 12 : 1 pc. Sub Handle Ass'y : 1 set Chip Guard Ass'y : 1 set Tool Box : 1 pc. D Punch / Die 22 mounted on machine 		<ul style="list-style-type: none"> Hose Kit Ass'y : 1 set Hose Cord Ass'y : 1 set 4 mm / 5 mm Hex. Socket Screw Key : Each 1 pc. Spanner : 1 pc. Spanner 12 : 1 pc. Sub Handle Ass'y : 1 set Chip Guard Ass'y : 1 set Tool Box : 1 pc. D Punch / Die 22 mounted on machine 		<ul style="list-style-type: none"> Hose Kit Ass'y : 1 set Hose Cord Ass'y : 1 set 4 mm / 5 mm Hex. Socket Screw Key : Each 1 pc. Spanner : 1 pc. Spanner 12 : 1 pc. Sub Handle Ass'y : 1 set Chip Guard Ass'y : 1 set Tool Box : 1 pc. D Punch / Die 22 mounted on machine 			
Optional Parts	PN	Part Name	Unit	Model	PN	Part Name	Unit	Model
	TB02506	Hose Kit Ass'y 5 m	1 set	HS series	TB02545	Switch Cord Ass'y 10 m	1 set	HS series
	TP05184	Ultra-high pressure hose 5 m	1 pc.		TB02141	Foot Switch Ass'y	1 set	
	TB02390	Switch Cord Ass'y 5 m	1 set		TA92729	Oil Can Ass'y	1 set	
	TP05777	Ultra-high pressure hose 10 m	1 pc.		TB02142	Hook Clamp Ass'y	1 set	

HYDRAULIC PUMP for SELFER ACE
Model **HPD-05**

Double-Acting

415 mm 426.4 mm

Specifications

Model	HPD-05	
Power Source (Single Phase)	115 V / 230 V AC	
Max. Output Pressure	MPa (kgf/cm ²) 68.65 (700)	
Output	50 Hz	60 Hz
At No Load	L/min 1.20	1.44
At 68.65 MPa	L/min 0.55	0.66
Motor	0.4 kW 4P	
Reservoir Capacity	L 4.0	
Discharge Port	Rc 3/8	
Electro-Magnetic Valve	4 way 3 position valve	
Mass (Weight)	kg 32.5	

**Punch, return, and reset operations are fully automatic.
An emergency switch stops the punch instantly at any time.**

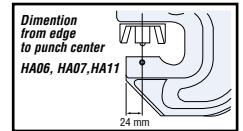

SELFER
Model **HA06-1322**

524.1 mm 381 mm

- Max. Punching Thickness : 13 mm
- Max. Punching Diameter : 22 mm
- Max. Throat Depth : 60 mm

SELFER
Model **HA07-1624**

545.6 mm 418 mm

- Max. Punching Thickness : 16 mm
- Max. Punching Diameter : 24 mm
- Max. Throat Depth : 70 mm

SELFER
Model **HA11-1624**

545.6 mm 436 mm

- Max. Punching Thickness : 16 mm
- Max. Punching Diameter : 24 mm
- Max. Throat Depth : 110 mm

Specifications

In case of mild steel maximum punching thickness must be decided based on the equation of $0.8 \times$ punching diameter. For details see the instruction manual.

Model	HA06-1322	HA07-1624	HA11-1624					
Max. Throat Depth	mm 60	70	110					
Punching Capacity	for Mild Steel	for Mild Steel	for Mild Steel					
Max. Punching Thickness	mm 13	16	16					
Max. Punching Diameter	mm 22	24	24					
Hole Making Time	10.5 sec.	16.5 sec.	16.5 sec.					
Allowable Max. Pressure	MPa (kgf/cm ²) 68.65 (700)	68.65 (700)	68.65 (700)					
Max. Output	kN (tf) 304 (31)	431 (44)	431 (44)					
Ram Stroke	mm 21	25	25					
Mass (Weight)	kg 21.5	28.5	35.5					
Standard Accessories	<ul style="list-style-type: none"> • Sub Handle Ass'y : 1 set • Hose Cord Ass'y : 1 set • 4 mm Hex. Socket Screw Key : 1 pc. • Spanner : 1 pc. • Tool box : 1 pc. • D Punch / Die 22 mounted on machine 	<ul style="list-style-type: none"> • Sub Handle Ass'y : 1 set • Hose Cord Ass'y : 1 set • 4 mm Hex. Socket Screw Key : 1 pc. • Spanner : 1 pc. • Tool box : 1 pc. • D Punch / Die 22 mounted on machine 	<ul style="list-style-type: none"> • Sub Handle Ass'y : 1 set • Hose Cord Ass'y : 1 set • 4 mm Hex. Socket Screw Key : 1 pc. • Spanner : 1 pc. • Tool box : 1 pc. • D Punch / Die 22 mounted on machine 					
Optional Parts	PN	Part Name	Unit	Model	PN	Part Name	Unit	Model
	TA96534	Hose Kit Ass'y 5 m	1 set	HA series	TA95307	Switch Cord Ass'y 10 m	1 set	HA series
	TP05184	Ultra-high pressure hose 5 m	1 pc.		TA94386	Foot Switch Ass'y	1 set	
	TA93778	Switch Cord Ass'y 5 m	1 set		TA92729	Oil Can Ass'y	1 set	
	TA9B044	Hose Kit Ass'y 10 m	1 set		TA96342	Hook Clamp Ass'y	1 set	HA07-1624 HA11-1624
	TP05777	Ultra-high pressure hose 10 m	1 pc.					

HYDRAULIC PUMP for HA Type
Model **SC-05**

Single-Acting

380 mm 324 mm

Specifications

Model	SC-05	
Power Source (Single Phase)	115 V / 230 V AC	
Max. Output Pressure	MPa (kgf/cm ²) 68.65 (700)	
Output	50 Hz	60 Hz
At No Load	L/min 1.20	1.44
At 68.65 MPa	L/min 0.55	0.66
Motor	0.4 kW 4P	
Reservoir Capacity	L 4.0	
Discharge Port	Rc 3/8	
Mass (Weight)	kg 27.5	

Built-in hydraulic pump shows its power in making round or elongated holes in flat bar, angle bar or channel iron

HANDY SELFER
Model **E25-0615**  Double insulation



340.5 mm
357 mm

E Punch
E Die

Max. Punching Thickness : 6mm
Max. Punching Diameter : 15 mm
Max. Throat Depth : 25 mm

HANDY SELFER
Model **E55-0619**



420 mm
368 mm

EL Punch
EL Die

Max. Punching Thickness : 6mm
Max. Punching Diameter : 19 mm
Max. Throat Depth : 55 mm

Specifications

Model	E25-0615		E55-0619							
Power Source (Single Phase)	220 - 240 V AC, 50/60 Hz		115 V AC, 50/60 Hz	220 - 240 V AC, 50/60 Hz						
Motor	Rated Power Consumption	W	305	670						
	Rated Current	A	1.6	6.0						
Max. Punching Diameter	mm	15	19							
Max. Punching Thickness	mm	6	6							
Max. Throat Depth	mm	25	55							
Punching Time	sec (single pass)	4	2							
Power Cord	m	2.4	2.4							
Mass (Weight)	kg	7.0	14							
Standard Accessories	<ul style="list-style-type: none"> • E Punch 15 : 1 pc. • E Die 15A : 1 pc. • E Die 15B : 1 pc. • Spanner 8 : 1 pc. • 10 x 12 mm Spanner : 1 pc. • 2.5 mm Hex. Socket Screw Key : 1 pc. • 4 mm Hex. Socket Screw Key : 1 pc. • Auxiliary Oil : 1 pc. 		<ul style="list-style-type: none"> • EL Punch 18 : 1 pc. • EL Die 18A : 1 pc. • EL Die 18B : 1 pc. • Spanner 10 x 12 mm : 1 pc. • 3 mm Hex. Socket Screw Key : 1 pc. • 4 mm Hex. Socket Screw Key : 1 pc. • 5 mm Hex. Socket Screw Key : 1 pc. • Stand Ass'y : 1 set • Auxiliary Oil : 1 pc. 							
Optional Accessory	 <table border="1"> <thead> <tr> <th>PN</th> <th>Part Name</th> <th>Sales Unit</th> </tr> </thead> <tbody> <tr> <td>TB00800</td> <td>Stand Ass'y</td> <td>1 set</td> </tr> </tbody> </table>		PN	Part Name	Sales Unit	TB00800	Stand Ass'y	1 set		
PN	Part Name	Sales Unit								
TB00800	Stand Ass'y	1 set								

Selection of Dies

Application	Type of Die	Plate Thickness (mm)		Model
		Mild Steel	Stainless Steel	
For thin sheets	A	2 - 3.2	Max. 3	E25-0615
For thick sheets	B	4 - 6	Max. 4	
For thin sheets	A	2 - 3.2	Max. 3	E55-0619
For thick sheets	B	4 - 6	Max. 4	
For channel iron	C	7 - 8	—	

Punching Capacity in channel iron (E55-0619)

Punching Dia. Size	10 OD	11 OD	12 OD	13 OD	14 OD	15 OD	16 OD
75 x 40 t7	○	○	○	○	○	○	○
100 x 50 t7.5	○	○	○	○	○	○	—
125 x 65 t8	○	○	○	○	○	—	—

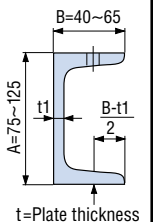

Punches & Dies for SELFER Puncher

Sales Unit : 1 Piece

FOR HS06-1624/HS07-1624/HS11-1624/HA06-1624/HA07-1624/HA11-1624

•TA99037 Lock Nut Ass'y is required for Elongated hole D Punch 25 x 9/12/14/18

Elongated hole D Punch		Elongated hole D Die		Elongated hole Jig	
PN	Size	PN	Size	PN	Size
TJ13229	D Punch 16 x 8	TJ13238	D Die 16 x 8	TK00455	Jig 16 x 8
TJ13230	D Punch 18 x 9	TJ13239	D Die 18 x 9	TK00456	Jig 18 x 9
TJ13231	D Punch 20 x 10	TJ13240	D Die 20 x 10	TK00457	Jig 20 x 10
TJ13232	D Punch 22 x 11	TJ13241	D Die 22 x 11	TK00458	Jig 22 x 11
TJ13233	D Punch 24 x 12	TJ13242	D Die 24 x 12	TK00459	Jig 24 x 12
TJ13234	D Punch 25 x 9	TJ13243	D Die 25 x 9	TK00460	Jig 25 x 9
TJ13235	D Punch 25 x 12	TJ13244	D Die 25 x 12	TK00461	Jig 25 x 12
TJ13236	D Punch 25 x 14	TJ13245	D Die 25 x 14	TK00462	Jig 25 x 14
TJ13237	D Punch 25 x 18	TJ13246	D Die 25 x 18	TK00463	Jig 25 x 18

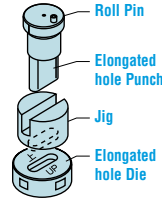

Optional

PN	Part Name
TQ01279	Hex. Setscrew 8 x 14 for Elongated hole Die
TA99037	Lock Nut Ass'y for D Punch 25

FOR HS06-1624/HS07-1624/HS11-1624/HA06-1624/HA07-1624/HA11-1624

Round hole D Punch		Round hole D Die	
PN	Size	PN	Size
TJ10778	D Punch 8	TJ10779	D Die 8
TJ11088	D Punch 9	TJ11089	D Die 9
TJ06700	D Punch 10	TJ06701	D Die 10
TJ06698	D Punch 11	TJ06699	D Die 11
TJ06696	D Punch 12	TJ06697	D Die 12
TJ06694	D Punch 13	TJ06695	D Die 13
TJ06692	D Punch 14	TJ06693	D Die 14
TJ06611	D Punch 14.5	TJ06612	D Die 14.5
TJ06690	D Punch 15	TJ06691	D Die 15
TJ06688	D Punch 16	TJ06689	D Die 16
TJ06686	D Punch 17	TJ06687	D Die 17
TJ06609	D Punch 17.5	TJ06610	D Die 17.5
TJ06684	D Punch 18	TJ06685	D Die 18
TJ06682	D Punch 19	TJ06683	D Die 19
TJ06680	D Punch 20	TJ06681	D Die 20
TJ06607	D Punch 20.5	TJ06608	D Die 20.5
TJ06678	D Punch 21	TJ06679	D Die 21
TJ07979	D Punch 21.5	TJ07980	D Die 21.5
TJ06676	D Punch 22	TJ06677	D Die 22
TJ06674	D Punch 23	TJ06675	D Die 23
TJ06566	D Punch 23.5	TJ06569	D Die 23.5
TJ07748	D Punch 24	TJ07749	D Die 24
TJ10061	D Punch 25	TJ10062	D Die 25

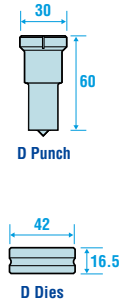

•TA99037 Lock Nut Ass'y is required for D Punch 25

FOR E25-0615

Round hole E Punch		Round hole E Die (Type A for thin sheets)		E Die (Type B for thick sheets)	
PN	Size	PN	Size	PN	Size
TK00100	E Punch 4	TK00101	E Die 4A	—	—
TK00102	E Punch 5	TK00103	E Die 5A	TK00104	E Die 5B
TK00143	E Punch 5.5	TK00144	E Die 5.5A	TK00145	E Die 5.5B
TK00105	E Punch 6	TK00106	E Die 6A	TK00107	E Die 6B
TK00146	E Punch 6.5	TK00147	E Die 6.5A	TK00148	E Die 6.5B
TK00111	E Punch 8	TK00112	E Die 8A	TK00113	E Die 8B
TK00149	E Punch 8.5	TK00150	E Die 8.5A	TK00151	E Die 8.5B
TK00117	E Punch 10	TK00118	E Die 10A	TK00119	E Die 10B
TK00120	E Punch 11	TK00121	E Die 11A	TK00122	E Die 11B
TK00123	E Punch 12	TK00124	E Die 12A	TK00125	E Die 12B
TK00097	E Punch 13	TK00098	E Die 13A	TK00099	E Die 13B
TK00167	E Punch 14	TK00168	E Die 14A	TK00169	E Die 14B
TK00428	E Punch 15	TK00288	E Die 15A	TK00429	E Die 15B

Elongated hole E Punch		Elongated hole E Die (Type A for thin sheets)		Elongated hole E Die (Type B for thick sheets)	
PN	Size	PN	Size	PN	Size
TK00126	E Punch 10 x 5	TK00127	E Die 10 x 5A	TK00128	E Die 10 x 5B
TK00158	E Punch 10 x 6.5	TK00159	E Die 10 x 6.5A	TK00160	E Die 10 x 6.5B
TK00129	E Punch 12 x 6	TK00130	E Die 12 x 6A	TK00131	E Die 12 x 6B
TK00152	E Punch 13 x 6.5	TK00153	E Die 13 x 6.5A	TK00154	E Die 13 x 6.5B
TK00155	E Punch 13 x 8.5	TK00156	E Die 13 x 8.5A	TK00157	E Die 13 x 8.5B

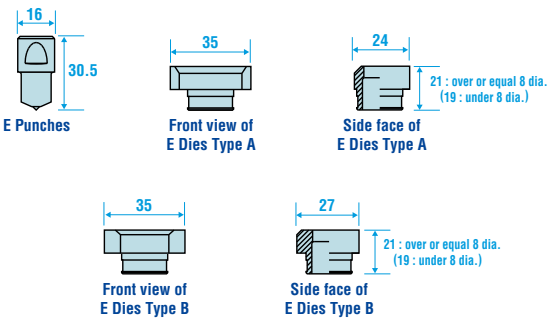

FOR E55-0619

Elongated hole E Punch		Elongated hole E Die (Type A for thin sheets)		Elongated hole E Die (Type B for thick sheets)	
PN	Size	PN	Size	PN	Size
TK00242	EL Punch 10 x 6.5	TK00254	EL Die 10 x 6.5A	TK00266	EL Die 10 x 6.5B
TK00243	EL Punch 13 x 6.5	TK00255	EL Die 13 x 6.5A	TK00267	EL Die 13 x 6.5B
TK00244	EL Punch 13 x 8.5	TK00256	EL Die 13 x 8.5A	TK00268	EL Die 13 x 8.5B
TK00245	EL Punch 13.5 x 9	TK00257	EL Die 13.5 x 9A	TK00269	EL Die 13.5 x 9B
TK00246	EL Punch 15 x 10	TK00258	EL Die 15 x 10A	TK00270	EL Die 15 x 10B
TK00247	EL Punch 16.5 x 11	TK00259	EL Die 16.5 x 11A	TK00271	EL Die 16.5 x 11B
TK00248	EL Punch 17 x 8.5	TK00260	EL Die 17 x 8.5A	TK00272	EL Die 17 x 8.5B
TK00249	EL Punch 18 x 9	TK00261	EL Die 18 x 9A	TK00273	EL Die 18 x 9B
TK00250	EL Punch 18 x 12	TK00262	EL Die 18 x 12A	TK00274	EL Die 18 x 12B
TK00251	EL Punch 19.5 x 13	TK00263	EL Die 19.5 x 13A	TK00275	EL Die 19.5 x 13B
TK00252	EL Punch 20 x 10	TK00264	EL Die 20 x 10A	TK00276	EL Die 20 x 10B
TK00253	EL Punch 21 x 14	TK00265	EL Die 21 x 14A	TK00277	EL Die 21 x 14B

Round hole EL Punch		Round hole EL Die (Type A for thin sheets)		Round hole EL Die (Type B for thick sheets)		Round hole EL Die (Type C for channel iron)	
PN	Size	PN	Size	PN	Size	PN	Size
TK00193	EL Punch 6	TK00208	EL Die 6A	TK00222	EL Die 6B	—	—
TK00194	EL Punch 6.5	TK00209	EL Die 6.5A	TK00223	EL Die 6.5B	—	—
TK00195	EL Punch 8	TK00210	EL Die 8A	TK00224	EL Die 8B	—	—
TK00196	EL Punch 8.5	TK00211	EL Die 8.5A	TK00225	EL Die 8.5B	—	—
TK00197	EL Punch 10	TK00212	EL Die 10A	TK00226	EL Die 10B	TK00235	EL Die 10C
TK00198	EL Punch 11	TK00213	EL Die 11A	TK00227	EL Die 11B	TK00236	EL Die 11C
TK00199	EL Punch 12	TK00214	EL Die 12A	TK00228	EL Die 12B	TK00237	EL Die 12C
TK00200	EL Punch 13	TK00215	EL Die 13A	TK00229	EL Die 13B	TK00238	EL Die 13C
TK00201	EL Punch 14	TK00216	EL Die 14A	TK00230	EL Die 14B	TK00239	EL Die 14C
TK00202	EL Punch 15	TK00217	EL Die 15A	TK00231	EL Die 15B	TK00240	EL Die 15C
TK00203	EL Punch 16	TK00218	EL Die 16A	TK00232	EL Die 16B	TK00241	EL Die 16C
TK00204	EL Punch 17	TK00219	EL Die 17A	TK00233	EL Die 17B	—	—
TK00205	EL Punch 18	TK00220	EL Die 18A	TK00234	EL Die 18B	—	—
TK00278	EL Punch 18.5	TK00279	EL Die 18.5A	TK00280	EL Die 18.5B	—	—
TK00180	EL Punch 19	TK00181	EL Die 19A	TK00182	EL Die 19B	—	—

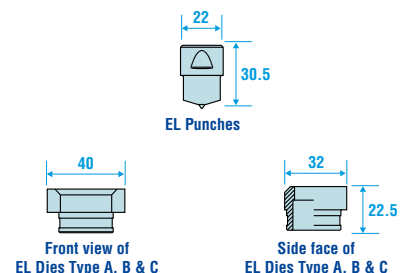

Compact portable models meet your versatile chamfering jobs

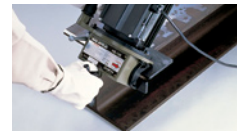

HAND BEVELER

Model **HB-15B**

Electric **E** Mild Steel **15C**

295 mm
220 mm
(Photo: 230 V AC Type)

Finish a surface so fine that post-sanding is unnecessary

Column R-section can be chamfered with optional attachment

Insert with 4-side blades per piece practices good economy

MINI BEVELER

Model **EMB-0307B**

Electric **E** Double insulation

Stainless Steel **3C** Mild Steel **7C**
4R **4R**

189.6 mm
179 mm 316.4 mm

Applicable to stainless steel and mild steel chamfering

Pipe outer edge can be also processed with standard accessories

Dust box collects swarf and chips effectively

MINI BEVELER

Model **MB-03A**

Electric **E** Double insulation

Mild Steel **3C**
2R, 3R

107.5 mm
150 mm 278 mm

An outer R-part attachment allows chamfering of outer diameters with a radius greater than 170 mm

An optional inner head ass'y allows chamfering a pipe of inner diameter larger than 100 mm (50R)

CIRCUIT BEVELER

Model **ECB-0203**

Electric **E** Double insulation

Stainless Steel **1.5C** Mild Steel **3C**
2R **3R**

400 mm 136.4 mm

Applicable to stainless steel and mild steel chamfering

Minimum chamfering plate thickness is 2 mm (Max. 0.5C)

An optional straight plate allows chamfering a straight edge shoulder

Specifications

Model (Electric Tool)	HB-15B		EMB-0307B		MB-03A		ECB-0203	
Power Source (Single Phase)	115 V AC	230 V AC	220 - 240 V AC, 50/60 Hz		230 V or 115 V AC, 50/60 Hz		220 - 240 V AC, 50/60 Hz	
Rated Power Consumption	W	910	910	1,010	430	450		
Rated Current	A	10.5	4	4.6	2 / 4.5	2.1		
Rated Duty	min	Continuous		Continuous	30	30		
No-load Speed	min ⁻¹ (rpm)	3,340	2,750	11,000	11,000	11,000		
Chamfering Capacity	Mild Steel	OC - 15C (7C per chamfering)		OC - 7C, 2R, 3R, 4R	OC - 3C, 2R, 3R	OC - 3C, ※2R, ※3R		
	Stainless Steel	—		OC - 3C, 2R, 3R, 4R	—	OC - 1.5C, ※2R		
Chamfer Angle		15° - 45°		15° - 45°	45°	45°		
Power Cord	m	5		4	2.5	2.5		
Mass (Weight)	kg	15		3.9	2.5	2.5		
Standard Accessories		<ul style="list-style-type: none"> • 4 / 5 / 6 mm Hex. Socket Screw Key : each 1 pc. • Spanner 24 × 27 : 1 pc. • Hook spanner 25-28 : 1 pc. • 3 mm T Wrench Key : 1 pc. • TA9A093 Insert 12.7 Ass'y (12 pcs./set) : 1 set 		<ul style="list-style-type: none"> • Carbon Brush Ass'y : 1 pc. • 4 mm Hex. Wrench Key : 1 pc. • Insert 12.7 with hole : 1 pc. • Insert Set Screw 4 × 7 : 1 pc. • Hex Nut M8 : 2 pcs. • 8 × 25 mm Hex. Socket Set Screw : 2 pcs. • Spanner T-15D : 1 pc. 	<ul style="list-style-type: none"> • 3 & 4 mm Hex. Socket Screw Key : each 1 pc. • Spanner T-9F : 1 pc. • Hex. Nut M8 : 2 pcs. • 8 × 25 mm Hex. Socket Set Screw : 2 pcs. 	<ul style="list-style-type: none"> • Insert 12.7 with hole : 1 pc. • Insert set screw 4 × 7 : 1 pc. • 5 mm Hex. Socket Screw Key : 1 pc. • Spanner 8 × 10 : 1 pc. • Spanner T-15D : 1 pc. • Adjustment gauge : 1 pc. 		

※In case of chamfering 3R, an optional insert for 3R is necessary, and chamfering 2R, an optional guide sleeve 24 mm dia. and insert for 2R are necessary.

The limit of beveling width depends on a chamfer angle.

Chamfer Angle α	HB-15B		EMB-0307B		MB-03A		ECB-0203		AMBL-0307 / AMB-0307		CB-02					
	Mild Steel (mm)	Mild Steel (mm)	Stainless Steel (mm)	Mild Steel (mm)	Mild Steel (mm)	Stainless Steel (mm)	Mild Steel (mm)	Stainless Steel (mm)	Mild Steel (mm)	Stainless Steel (mm)	Mild Steel (mm)	Mild Steel (mm)				
45°	15	15	7	7	3	3	3	3	1.5	1.5	7	7	3	3	2	2
30°	9	15.5	3.8	6.6	2.2	3.8					4	7	2.2	3.8		
15°	4	15.4	1.5	5.6	1	3.8					2.2	8	1	3.8		

Model	EMB-0307B		MB-03A	ECB-0203		AMBL-0307 / AMB-0307		CB-02
Material	Mild Steel	Stainless Steel	Mild Steel	Mild Steel	Stainless Steel	Mild Steel	Stainless Steel	Mild Steel
Radius (mm)	2, 3, 4	2, 3, 4	2, 3	2, 3	2	2, 3, 4	2, 3, 4	2

Chamfering range of operation

CB-02

- Min. Diameter: ≥ 10 mm
- Min. Radius: ≥ 6 mm
- Min. Depth: ≥ 20 mm

ECB-0203

- Min. Diameter: ≥ 15 mm
- Min. Radius: ≥ 15 mm
- Min. Depth: ≥ 18 mm
- Min. Thickness: ≥ 2 mm

Select the suitable BEVELER model in accordance with your applications



MINI BEVELER
Model **AMBL-0307** *Lever Type*

Stainless Steel
3C
Mild Steel
7C
4R

Model **AMB-0307** *Ring Type*

Applicable to stainless steel and mild steel chamfering

Simple to adjust chamfering depth and replace insert

Pipe outer edge can be also processed with standard accessories

CIRCUIT BEVELER
Model **CB-02**

Mild Steel
2C
2R

Precisely adjust chamfer dimensions with accessory gauge

Versatility chamfer either inner or outer edges

Specifications

Model (Pneumatic Tool)		AMBL-0307 / AMB-0307	CB-02
Air Pressure	MPa (kgf/cm ²)	0.59 (6)	0.59 (6)
Air Consumption	m ³ /min	0.9	0.4
No-load Speed	min ⁻¹ (rpm)	14,000	13,000
Chamfering Capacity	Mild Steel	0C - 7C, 2R, 3R, 4R	0C - 2C, 2R
	Stainless Steel	0C - 3C, 2R, 3R, 4R	—
Chamfer Angle		15° - 45°	45°
Mass (Weight)	kg	2.9	1.8
Standard Accessories		<ul style="list-style-type: none"> • 3 & 4 mm Hex. Socket Screw Key : each 1 pc. • Spanner T-15F : 1 pc. • Hex Nut M8 : 2 pcs. 	<ul style="list-style-type: none"> • 8 x 25 mm Hex. Socket Set Screw : 2 pcs. • Insert Set Screw 4 x 7 : 1 pc.
		<ul style="list-style-type: none"> • Insert 9.525 with hole : 1 pc. • Adjustment gauge : 1 pc. • Spanner T-9F : 1 pc. 	<ul style="list-style-type: none"> • Protective cap : 1 pc. • Hook Spanner 58-65 : 1 pc.

Optional

	PN	Description	Sales Unit	Application model	Remarks
	TA9A093	Indexable Insert 12.7 Ass'y	12 pcs./set	HB-15B	
	TB01159	Indexable Insert 12.7 with hole Ass'y	10 pcs./set	EMB-0307B, AMB-0307, AMBL-0307, ECB-0203	
	TB01791	Indexable Insert 12.7 Ass'y R2	10 pcs./set	EMB-0307B, AMB-0307, AMBL-0307, ECB-0203	
	TB01651	Indexable Insert 12.7 Ass'y R3	10 pcs./set	EMB-0307B, AMB-0307, AMBL-0307, ECB-0203	
	TB01790	Indexable Insert 12.7 Ass'y R4	10 pcs./set	EMB-0307B, AMB-0307, AMBL-0307	
	TA9A386	Indexable Insert 9.525 with hole Ass'y	10 pcs./set	MB-03A, CB-02	
	TA9A592	Indexable Insert 9.525 Ass'y R2	10 pcs./set	MB-03A, CB-02	
	TA9A638	Indexable Insert 9.525 Ass'y R3	10 pcs./set	MB-03A	
	TA9A728	Plate Ass'y for pipe	1 set	HB-15B	For pipe 125 - 800 mm dia.
	TB02539	Attachment for small dia. pipe	1 set	EMB-0307B, AMB-0307, AMBL-0307	For pipe 80 - 200 mm dia.
	TA9A594	Inner head Ass'y	1 set	MB-03A	For min. 100 mm dia.
	TB02857	Guide sleeve 24 mm dia. Ass'y	1 set	ECB-0203	For chamfering R2
	TB03097	Plate Ass'y for straight line use	1 set	ECB-0203	
	TB02862	Dust Box Ass'y	1 set	ECB-0203	Used with Plate Ass'y for straight line use
	TB03424	Spanner T-9D	1 pc.	MB-03A, CB-02	
	TQ01683	Spanner T-15D	1 pc.	EMB-0307B, AMB-0307, AMBL-0307, ECB-0203	

OTHER PRODUCT LINES

Power Tools *Pneumatic & Electric Power Tools, Labor-saving plus Improved Work Efficiency*

A wide range of unique tools for boring and punching



delvo *Professional Tools for High Technology*

NITTO KOHKI "delvo" Electric Screwdrivers are high-quality tools for professional use, with special emphasis on precise control of torque and long life. They apply just the correct amount of torque –with sure, positive control always at your fingertips. They're smooth and shockless in operation, too. NITTO KOHKI's customer-oriented service system is directly connected to sales agents to ensure that you can use "delvo" Electric Screwdrivers with confidence.

delvo Models

- DLV7300 Series
- DLV7500/8500 Series
- DLV7000/8000 Series
- DLV7100/7200/8100/8200 Series
- DLV3100/3300 Series
- DLV5720/5720H/5740/5740H/5750 Series
- DLV5800 Series
- DLV30SP/30HP-MKG (with built-in brushless motors)

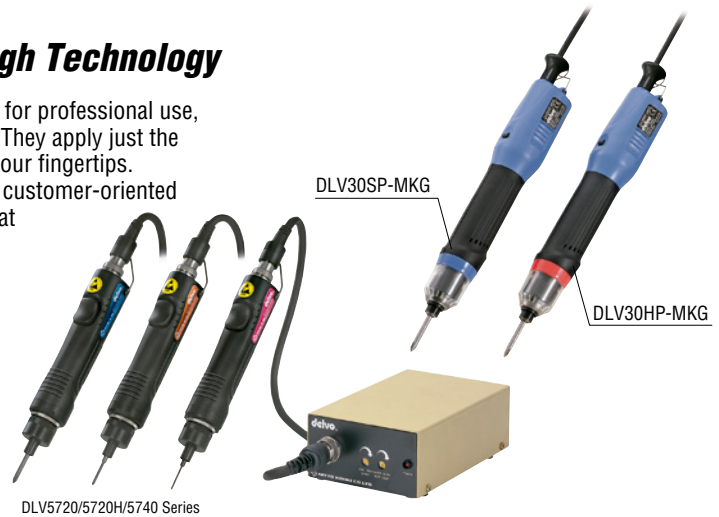

Spring Balancer

TIGON Spring Balancer Improves Work Safety & Efficiency

TIGON Spring Balancer Models

- TW-00/TW-0/TW-3/TW-5/TW-9/TW-15/TW-22/
- TW-30/TW-40/TW-50/TW-60/TW-70

Capacities ranging from 0.5 - 70 kg.



Linear Motor Driven Free Piston System

MEDO pumps are unique products featuring a Linear-motor-driven Free Piston System. NITTO KOHKI has made available a complete series of air compressors and suction pumps that incorporate this revolutionary mechanism. These are quite appropriate as air sources or suction power units for various pneumatically operated equipment and apparatus in advanced industries.



OTHER PRODUCT LINES

CUPLA

Quick Connecting Fluid Couplings are The World's Best for both Quality and Quantity



Full line-up consisting of 3,000 series, 20,000 type variations. The couplings eliminate inconvenience of thread-in or bolted flange connections, fluid leakage, or hose kinking but provide speedy control and maintenance of fluid piping.



HI CUPLA ACE

- Plastic Couplas with a built-in locking mechanism.
- Pressure ratings comparable to steel Couplas.



LINE CUPLA 200

- Enables several air lines to be taken simultaneously from one supply line.
- Gives speedy branching of Hi Coupla.

HI CUPLA & HI CUPLA 200

- One-way shut-off coupling with an automatic shut-off valve in the socket.
- Important parts are hardened for excellent wear resistance and durability.



Plug				P
For hose connection				
40PH	For 1/2" hose	400PH	For 1/2" hose	
20PH	For 1/4" hose	600PH	For 3/4" hose	
30PH	For 3/8" hose	800PH	For 1" hose	
For female thread connection				
40PM	For Rc 1/2"	400PM	For Rc 1/2"	
10PM	For Rc 1/8"	600PM	For Rc 1/2"	
20PM	For Rc 1/4"	800PM	For Rc 3/4"	
30PM	For Rc 3/8"	800PM	For Rc 1"	
For male thread connection				
20PF	For R 1/4"	400PF	For R 1/2"	
30PF	For R 3/8"	600PF	For R 3/4"	
40PF	For R 1/2"	800PF	For R 1"	
For male thread connection (parallel thread)				
20PFF	For G 1/4"			

Socket				S
For hose connection				
40SH	For 1/2" hose	400SH	For 1/2" hose	
20SH	For 1/4" hose	600SH	For 3/4" hose	
30SH	For 3/8" hose	800SH	For 1" hose	
For female thread connection				
40SM	For Rc 1/2"	400SM	For Rc 1/2"	
10SM	For Rc 1/8"	600SM	For Rc 1/2"	
20SM	For Rc 1/4"	800SM	For Rc 3/4"	
30SM	For Rc 3/8"	800SM	For Rc 1"	
For male thread connection				
20SF	For R 1/4"	400SF	For R 1/2"	
30SF	For R 3/8"	600SF	For R 3/4"	
40SF	For R 1/2"	800SF	For R 1"	

Specifications

Type	Hi Coupla	Hi Coupla 200
Body material	Steel (chrome-plated)	Steel (chrome-plated)
Size	1/8", 1/4", 3/8", 1/2", 3/4", 1"	1/8", 1/4", 3/8", 1/2"
Working pressure	1.5 MPa	1.0 MPa
Pressure resistance	2.0 MPa	1.5 MPa
Seal material	NBR	NBR
Working temperature range	-20°C - +80°C	-5°C - +60°C

For hose connection			
200-17SH	For 1/4" hose	200-40SH	For 1/2" hose
200-20SH	For 1/4" hose		
200-30SH	For 3/8" hose		
For female thread connection			
200-20SM	For Rc 1/4"		
200-30SM	For Rc 3/8"		
200-40SM	For Rc 1/2"		
For male thread connection			
200-20SF	For R 1/4"		
200-30SF	For R 3/8"		
200-40SF	For R 1/2"		

For Oxygen / Fuel Gas Mini Cupla Super

Heavy-duty push-to-connect type or oxyacetylene piping



Exclusively for welding and cutting equipment.

- From cylinders to torches, all piping connections associated with welding and cutting equipment are now in push-to-connect configurations.
- Chrome-plated body for better corrosion resistance.
- Heat-treated plugs for better durability.
- Oxygen and fuel gas couplings have different configuration sizes with sleeves in different appearances, chrome plating for oxygen and copper plating for fuel gas, to prevent accidental interconnection.
- Smaller diameter design enables wider range of applications.
- Various types of end configurations have been standardized to comply with a wide range of welding and cutting equipment applications. Interchangeable with Mini Cupla.

Select the combination in accordance with your own application.

Male thread	For regulator	For extension hose	For torch
Suggested combination	Suggested combination	Suggested combination	Suggested combination
SM x PH	SF x PH	SH x PH	SH x PF



Plug				P
PH type (Hose barb)				
S22PH	For Oxygen	For 1/4", 5/16"		
S33PH	For Fuel Gas	For 5/16", 3/8"		
S32PH*	For Fuel Gas	For 1/4", 5/16"		
PH type (Hose barb of smaller diameters)				
S225PH	For Oxygen	For 5 mm ID		
S335PH	For Fuel Gas	For 5 mm ID		
PF type (Female thread for torch connection)				
S22PF	For Oxygen	For oxygen torch side		
S33PF	For Fuel Gas	For fuel gas torch side		
PF8 type (Female thread with backflow stop valve)				
S23PF8-2*	For Oxygen	For oxygen torch side		
S33PF8-2*	For Fuel Gas	For fuel gas torch side		
PN type (Nut type for small diameter hose)				
S22PN	For Oxygen	For 5 mm ID		
S33PN	For Fuel Gas	For 5 mm ID		

Socket				S
SH type (Hose barb)				
S22SH	For Oxygen	For 1/4", 5/16"		
S33SH	For Fuel Gas	For 5/16", 3/8"		
S32SH*	For Fuel Gas	For 1/4", 5/16"		
SH type (Hose barb of smaller diameters)				
S225SH	For Oxygen	For 5 mm ID		
S335SH	For Fuel Gas	For 5 mm ID		
SF type (Female thread for torch connection)				
S22SF	For Oxygen	For oxygen gauge side		
S33SF	For Fuel Gas	For fuel gas gauge side		
S23SF*	For Oxygen	For oxygen gauge side		
S33SF*	For Fuel Gas	For fuel gas gauge side		
SM type (Male thread)				
S22SM	For Oxygen	For Rc 1/4"		
S33SM	For Fuel Gas	For Rc 3/8"		
SN type (Nut type for small diameter hose)				
S22SN	For Oxygen	For 5 mm ID		
S33SN	For Fuel Gas	For 5 mm ID		

Specifications

Body material	Socket : Brass (chrome-plated) Plug : Steel (chrome-plated)
Size	1/4", 5/16", 3/8"
Working pressure	0.7 MPa
Pressure resistance	1.0 MPa
Seal material	NBR
Working temperature range	-20°C - +80°C

*Made-to-order item.

• Available hose sizes are ø5 mm x ø11.2 mm, ø5 mm x ø11.5 mm and ø5 mm x ø11.8 mm.

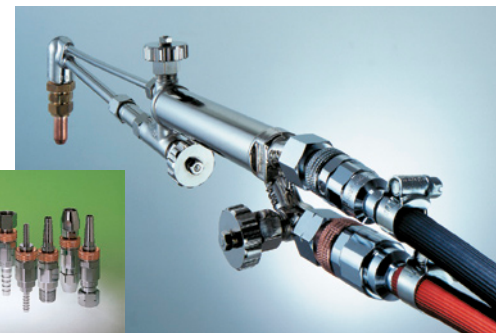

MACHINE TOOLS

**Technologies that Respond
to the Needs of the Times**



■ Overseas Affiliates/Offices

NITTO KOHKI U.S.A. INC.
TEL:+1-630-924-9393 FAX:+1-630-924-0303

NITTO KOHKI EUROPE CO., LTD.(UK)
TEL:+44-1923-239-668 FAX:+44-1923-248-815

NITTO KOHKI DEUTSCHLAND GMBH
TEL:+49-7157-22436 FAX:+49-7157-22437

NITTO KOHKI AUSTRALIA PTY. LTD.
TEL:+61-7-3340-4600 FAX:+61-7-3340-4640

**NITTO KOHKI CO., LTD. SINGAPORE
BRANCH**
TEL:+65-6227-5360 FAX:+65-6227-0192

**NITTO KOHKI CO., LTD. BANGKOK
REPRESENTATIVE OFFICE**
TEL:+66-2-632-0307 FAX:+66-2-632-0308

**NITTO KOHKI CO., LTD. SHANGHAI
REPRESENTATIVE OFFICE**
TEL:+86-21-6415-3935 FAX:+86-21-6472-6957

**NITTO KOHKI CO., LTD. SHENZHEN
REPRESENTATIVE OFFICE**
TEL:+86-755-8375-2185 FAX:+86-755-8375-2187

★ Specifications and designs are subject to change at any time without notice.

 **NITTO** Head Office
9-4, Nakaikagami 2-chome,
Ohta-ku, Tokyo 146-8555 Japan
NITTO KOHKI CO.,LTD. Phone : +81-3-3755-1111 Fax : +81-3-3753-8791

▶ URL : www.nitto-kohki.co.jp/e
▶ E-mail : overseas@nitto-kohki.co.jp

DISTRIBUTED BY