

2



Section 1
Traffic Management
Temporary Signage
Roadworks Equipment
Section 2
Highway Maintenance Products
Section 3
Pedestrian Guardrailing
Crash Barriers & Fencing
Section 4
Decorative & Amenity Bollards
Section 5
Amenity & Street Furniture
Section 6
Car Parks & Access Control

Traffic Signs	2-5
Street Nameplates	5
Sign Posts/Traffic Posts	6-7
Sign Fixings & Clips	8-11
Offset Bracketry, Post Accessories & Cut-outs	12-14
Globes & Galleries	14
Keys	15
Signlight Units	16
Service Boxes/Feeder Pillars	16-17
Illuminated Zebra Crossings & Centre Islands	18-19
Lighting Columns & Street Lighting	20
Amenity Lighting	21
Baselit Bollards	22
Internally Illuminated Box Signs	23
School Patrol Flasher Units	24
Flashing Signs - Vehicle & Timer Activated	25
Island Sites	26
Catseyes	27
Road Studs & Tactile Studs	27
Allegrini Marker Posts	28
Flexible Verge Marker Posts	28-29
Motorway & Trunk Road Marker Posts	29
Hydrant/Boundary Marker Posts	30
Salt & Grit Bins	30-31
Paint & Pre-cut Road Markings	31





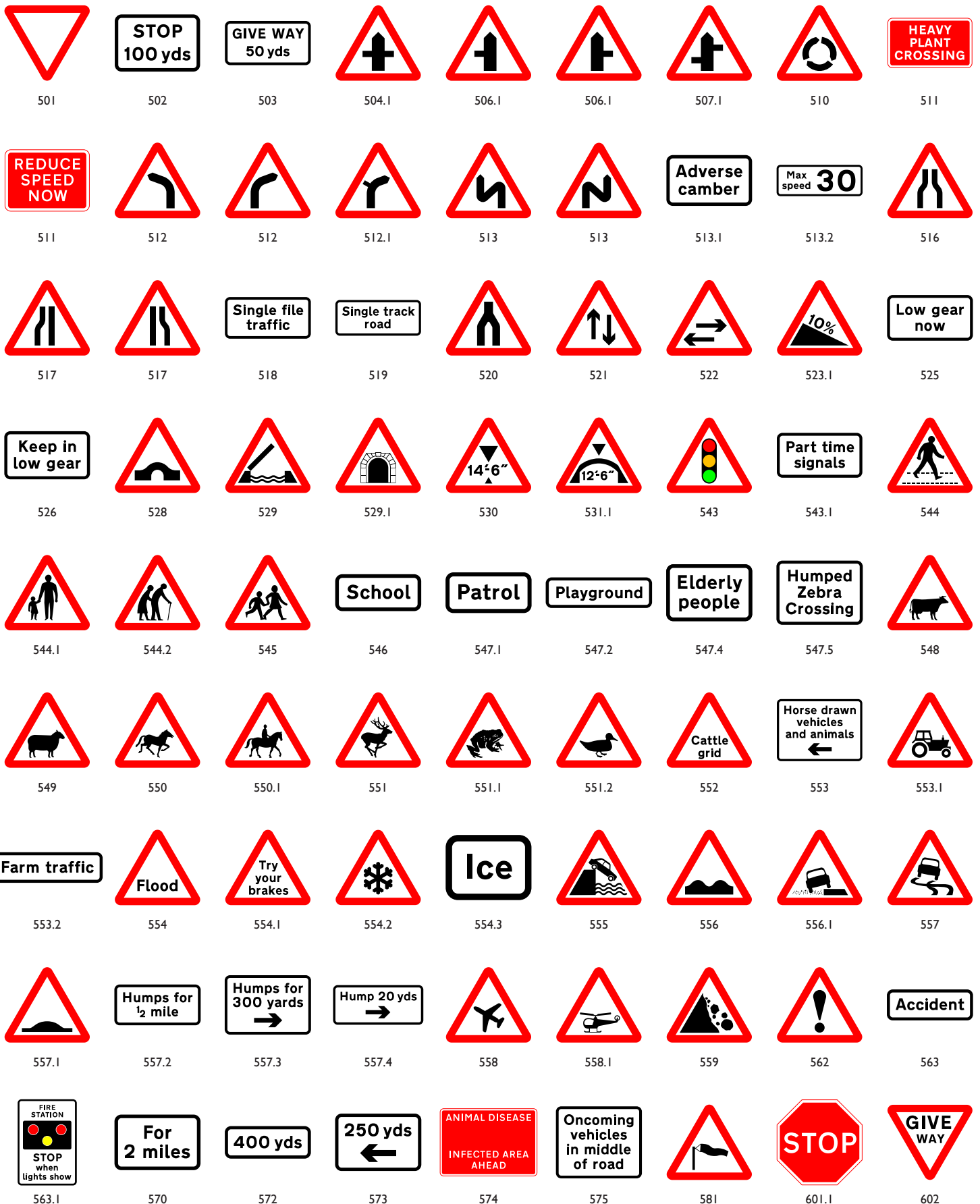

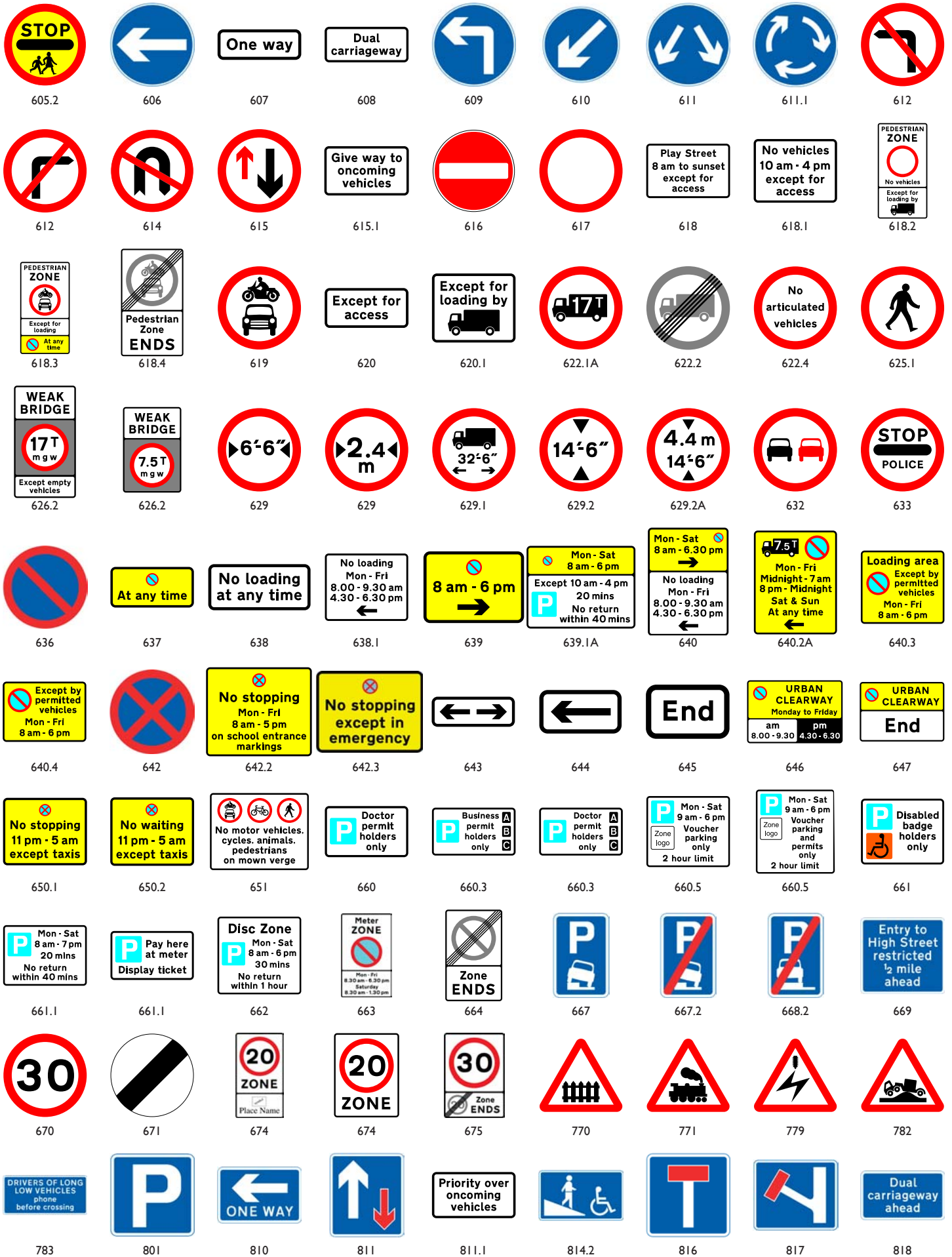









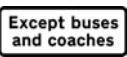
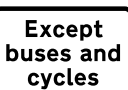





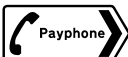





Traffic Signs

Signage details reproduced by kind permission of TSO from the current edition of The Traffic Sign Regulations and General Directions. Listed below is a selection of the more commonly used signs. All signs and variants in permitted sizes are available upon request. Signs are produced in all grades of reflective and non-reflective material.

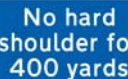



Traffic Signs *(continued)*

								
818.1	820	821	823	824	825	827.1	827.2	829.1
								
830	832.5	832.8	833	834	835	836	868	877
								
950	951	952	953.2	954	954.1	954.3	954.4	955
								
956	957	957	958	958.1	959	959	959.1	960
								
961	962	963	963.1	963.1	964	965	966	967
								
968	970	974	2205	2206	2207	2215	2322	2322
								
2323	2401	2402	2403	2501	2503	2504	2509	2603
								
2604	2606	2610	2701	2701	2702	2702	2702	2703
								
2703	2703	2704	2704	2706	2716	2901	2916	2930
								
2932	7001	7001.3	7003.1	7004	7005	7006	7006.1	7007.1

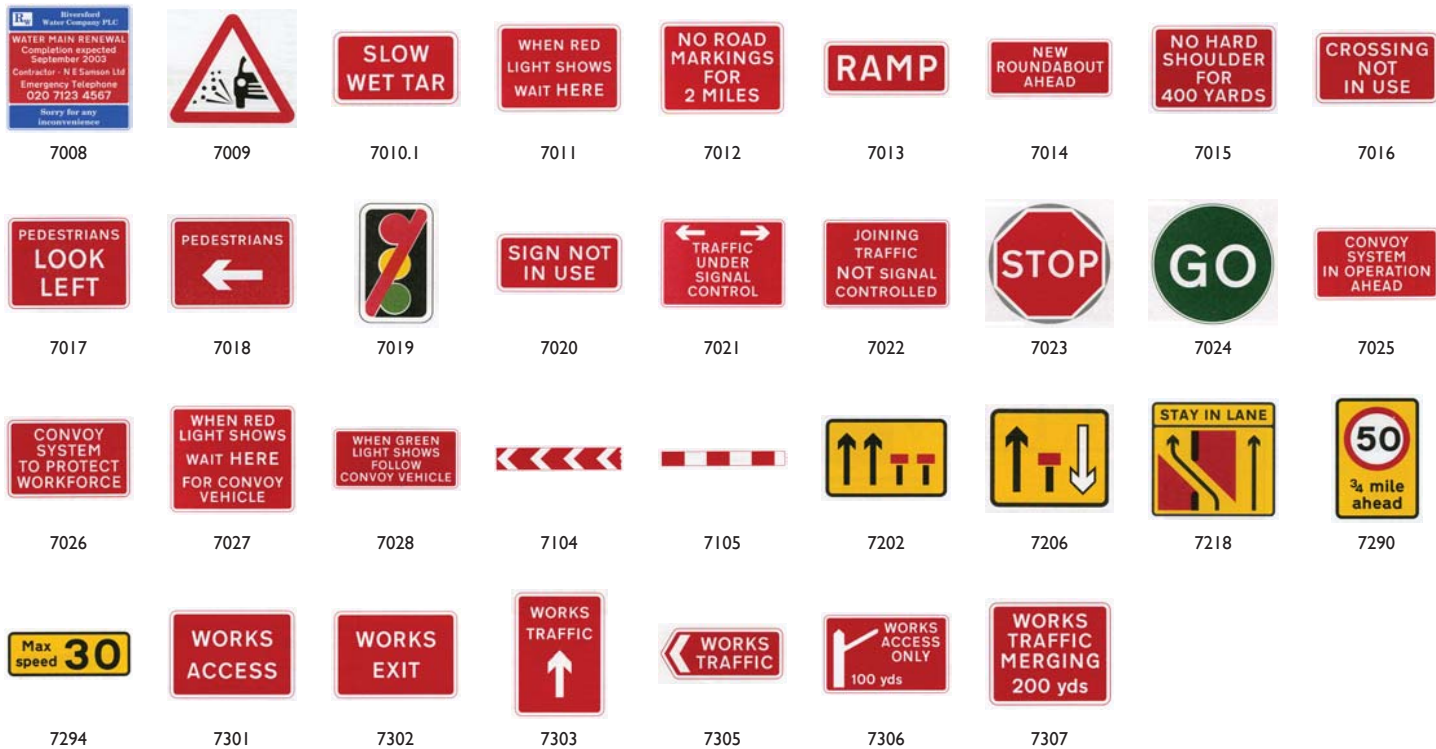

Street Nameplates

▼ Die pressed nameplate

Street nameplates manufactured to local authority specifications and comply to D.O.E. Circular No. Roads 12/72. Various supports also available including recycled.

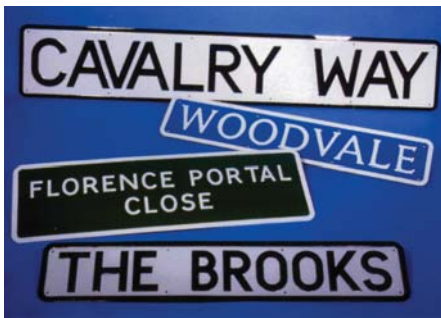

► Reflective nameplate

Shaped boundary sign with Class I High Intensity reflective face incorporating local crest.



◀ Reflective nameplate

Temporary local directional sign to Diag. 2701 manufactured with a Class 2 Engineer Grade reflective face.



◀ Machine engraved nameplates

Internal or external nameplates, notices and labels manufactured in stainless steel, aluminium, brass, perspex and laminated plastics.



▲ Polycarbonate nameplate

Polycarbonate street nameplate with sub-surface legend, mounted onto recycled back-board and leg supports.

► Sign Posts/Traffic Posts

▼ ► Range of posts

- Large base posts
- Straight posts
- Cantilever posts
- RHS posts
- Centre island columns
- Belisha beacon poles
- Straight and cranked signal poles
- Caps and baseplates



▼ Traffic sign posts

A large, comprehensive range is available of steel traffic sign posts and finishes, together with their base plates and post caps.

Circular hollow section (C.H.S.) is available from 48mm o.d. to 273mm o.d. and rectangular hollow section (R.H.S.) from 40mmx40mm to 250mmx150mm.

For the larger directional sign, rectangular sectional joists (R.S.J.) and universal beam posts (U.B.) can be supplied.

The most popular C.H.S. posts, 76mm o.d., are always available ex stock and therefore these can be delivered without delay, normally within a few days.

Large base posts, where signs are illuminated, are supplied with base section diameters of 140mm o.d. or 168mm o.d., with shaft varying from 76mm o.d. to 140mm o.d. Planting depth, door and cable entry provision vary with individual requirements. Again, 4.0mtr and 5.0mtr versions available from stock.

Base sections are complete with formed rolled-edge door, tamperproof triangular lock, impregnated baseboard and earthing screw.

Posts can be supplied in a number of finishes:

- Shotblasted, plastic-coated in Vyflex PVC PC80 TE.
- Hot-dip galvanised in self-colour or finished painted grey.
- Zinc-sprayed and finished painted grey.
- Aluminium-sprayed and grey-sealant paint finish.

Posts are mainly supplied in grey. However, other colours are available: for example, green is popular for signing in parks and in rural locations, and various colours can be supplied for theme parks and leisure centres.

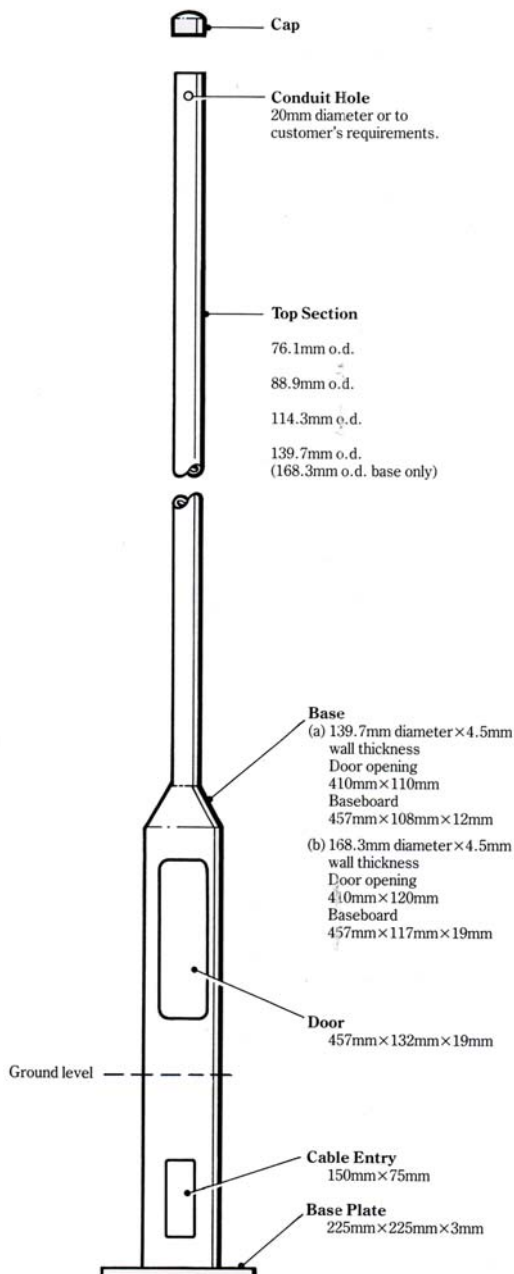

Standard large base post details			
Base diameter	Planting depth	Top section	Overall length
140mm	0.60m-1.050m	76mm, 89mm, 114mm	2m to 7.5m
168mm	0.60m-1.050m	76mm, 89mm, 114mm, 140mm	2m to 7.5m

▼ Centre island column

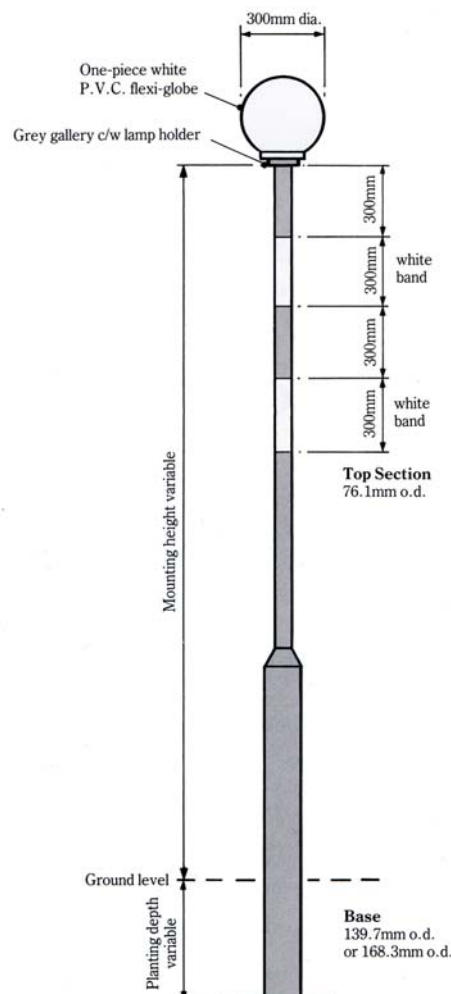

▼ Pedestrian beacon post

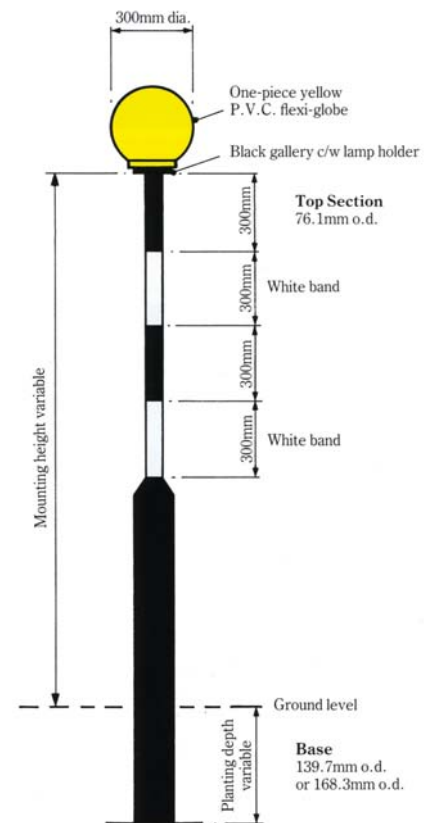

► Sign Fixings and Clips

Clips for round posts - specification AISI 304 stainless steel



◀ Anti-rotational clip

Supplied complete with 1 No. M8 bolt assembly. Fast, simple sign installations are achieved by inserting the 'foot' into channel and twisting the clip through 90°. The other end of the clip is then secured by the bolt. Raised pips on the inner face of these one-piece clips help prevent sign rotation. Suitable for all types of Channel extrusions.

Available in the following diameters:
50mm, 60mm, 76mm, 89mm, 102mm, 114mm



▲ Heavy duty 2-bolt 'D' clip with insert

Manufactured from 25mm (1") x 1.8mm (0.070") thick stainless steel, heavy duty clips are supplied with 2 No. M8 bolt assemblies and an insert plate. The bolts slot through and are attached to the insert plate and the unit is inserted into the channel as a whole. Non-standard sizes are available on request. Insert plates should always be used with these clips. They are an essential element of the design and should not be discarded.

Heavy duty clips should be used for the following post sizes:
127mm, 140mm, 168mm, 194mm, 219mm, 244mm, 273mm

► 2-Bolt 'D' clip

Provides 2 bolt security, complete with 2No. M8 bolt assemblies. Available in the following diameters:

76mm, 89mm, 102mm, 114mm



▼ Back to Back channel clip

Fitted with M8 bolts. Two clips are required per channel whether one or two post mounting.

Available in the following diameters:

50mm, 60mm, 76mm, 89mm, 102mm, 114mm, 127mm, 140mm, 168mm, 194mm, 219mm, 244mm

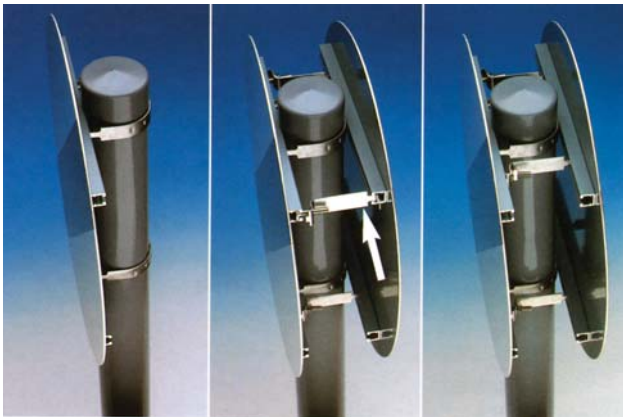

▼ 2-Bolt mini 'D' clip

Ideal for fixing signs to the vertical bars of guard rails, bridge parapets, etc. Supplied complete with 2 No. M8 bolt assemblies. Available in the following diameters:

13mm, 16mm, 19mm, 25mm



Clips for rectangular posts



▲ Standard RHS clip

Suitable for the smaller sizes of RHS post and supplied with 2No. M8 bolt assemblies.

Available in the following diameters:

50x50mm, 100x50mm, 80x40mm, 80x80mm

Clips for rectangular posts - specification AISI 304 stainless steel



◀ Heavy duty RHS clip with insert plate

Manufactured from 25mm (1") x 1.8mm (0.701") thick stainless steel and supplied with two M8 bolt assemblies and insert plates. Insert plates should always be used with these clips - they are an essential element of the design and should not be discarded. Non standard sizes available on request.

Available in the following diameters:

120x60mm, 120x80mm, 160x80mm, 150x100mm, 200x100mm, 250x150mm

Clips for rectangular posts - specification AISI 304 stainless steel (cont'd)



◀ 'Z' clip

For use on rectangular concrete motorway columns with a recess running down each side of the column. Made in 3.0mm stainless steel and swaged for strength. A set consists of 2 No 'Z' clips, two M8 assemblies and 1 No insert plate to slide in channel, with a punched hole at one end and a slot at the other to receive the bolts. N.B. The slot will accommodate any variation in width of support and enable 'Z' clips to lie flush against the side of the column. Always use the insert plates provided. Available in the following diameter:
With recess 76mm from face



▲ RSJ/Universal beam clamp

For use on all flanged supports including RSJs and Universal Beams. Made in 1.8mm gauge stainless steel and complete with appropriate M8 x 32mm (5/16" x 1 1/2") bolt, Nyloc nut and washer. The Nyloc nut is supplied to prevent loosening by traffic or wind vibration. RSJ clamps may be supplied plastic coated on request. Available as universal fit.

Important:

Never use bolts without the washers supplied, or the fixing will not remain secure. Where insert plates are supplied with clips they should always be used.

▼ Stainless steel banding

Packaging & application guide				
Band size		Packaging	Applications	
9.5mm	12.7mm		16mm	19mm
✓	✓	✓	✓	✓
Lightweight banding - 162'/50m rolls				
Cardboard packaging			Ideal for light signs and security applications such as fastening doors of lighting columns.	
Regular banding - 100'/30.48m rolls				
✓	✓	✓	PVC dispenser case Red case - 19mm; Green case - 16mm; Blue case - 12.7mm	
Suitable for most sign erection applications.				
Heavy duty banding - 100'/30.48m rolls				
✓	Cardboard dispenser case			For heavy duty applications such as large offset (cantilever) sign & traffic signal erection.

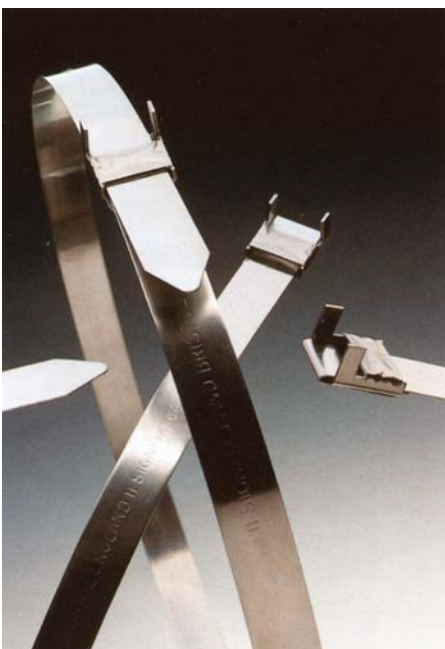

◀ Bucklestraps

Stainless steel bucklestraps are equal in strength and versatility to conventional methods of banding, but are far more convenient. Pre-cut to three standard lengths, they will save on average 3 minutes per fixing. Standard lengths are listed below, but special sizes are available on application. Signfix bucklestraps are manufactured in regular (0.73mm (0.029")) type 201 stainless steel.

Width	Size	Length	Maximum post diam.	Package qty
13mm (1/2")	1	460mm (18")	76mm (3")	50
13mm (1/2")	2	660mm (26")	150mm (6")	50
13mm (1/2")	3	1120mm (44")	300mm (12")	50
19mm (3/4")	1	460mm (18")	76mm (3")	50
19mm (3/4")	2	660mm (26")	150mm (6")	50
19mm (3/4")	3	1120mm (44")	300mm (12")	50

◀ Junior bucklestraps

These bucklestraps are designed for use only with the Junior channel clamp for the mounting of small signs such as time plates and dog fouling signs up to 0.2m² in area.

9.3mm (3/8")	1	460mm (18")	76mm (3")	100
9.3mm (3/8")	2	660mm (26")	150mm (6")	100
9.3mm (3/8")	3	1120mm (44")	300mm (12")	100

► Sign Fixings and Clips *(continued)*

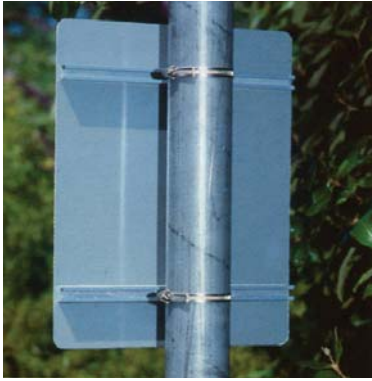

▼ Screw banding

Screw Band provides a fast and versatile solution for temporary sign applications and neighbourhood watch signs. For large diameter posts use two housings at opposite positions on the circumference.

Screw banding

Width	Size	Package quantity	Maximum post diam.	Thickness	Load
7mm (1/4")	1	30mm roll	150mm (6")	0.94mm (0.037")	2.53kN (556lb)
11mm (7/16")	2	30mm roll	225mm (9")	0.94mm (0.037")	4.54kN (1000lb)

Worm screws and housings

Size	Package quantity
7mm (1/4")	100 sets
11mm (7/16")	100 sets

Screwband bucklestraps

The versatility of Screwband packaged in convenient ready-cut lengths, complete with captive screw 'flip-lock housings.

Width	Size	Length	Maximum post diam.	Package quantity
7mm (1/4")	1	610m (24")	150mm (6")	50
11mm (7/16")	2	914m (36")	225mm (9")	50

Screw band application

1. Estimate length of band required, allowing about 25mm overlap plus 12mm for banding under housing. Cut off using snips. Bend approximately 12mm of band under housing.

2. Feed band around workpiece, introducing free end into the housing slot. Insert screw and tighten with an Allen key.

► Banding tool

Banding tools are made from forged alloy steel, zinc plated for full protection against corrosion. The tools are guaranteed against defective workmanship and/or materials for a period of 12 months from the date of purchase. The guarantee is conditional on the tools being well maintained and not abused in any way. The Regular Signfix banding tool has a tensioning capability of 2,400lbs and a built-in cutter. Permanent lubrication of the tension screw extends tool life and speed of clamping.

For use with Lightweight, Regular and Heavy Duty band.

► Tension nut

For use in place of the standard handle in restricted areas.

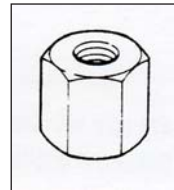

► Tension limiter

Used in place of the standard handle, it allows maximum tension limit to be adjusted. Each tension limiter is supplied with precise instructions.

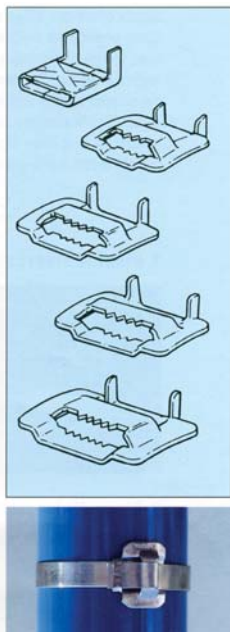
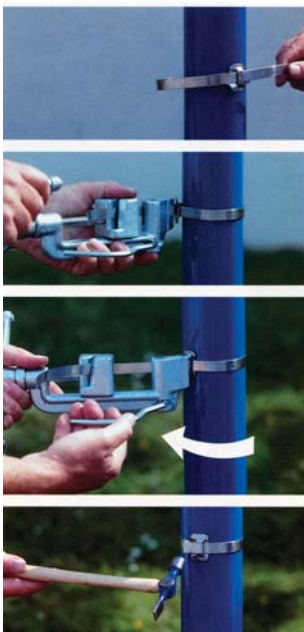

◀ Banding application

1. Push band through buckle, teeth towards the operator, ears up. Pass band around object and again through buckle. (For best results repeat this operation to obtain double banding.) Anchor end of band by folding back under buckle. Take up slack.
2. Place band in slots of tool and push nose of tool against the buckle. Grip band with clamped lever and apply tension by turning handle. Maximum pressure is being applied when there is no appreciable movement of band between nose and clamping block.
3. Swing tool over buckle. This movement increases tension of band and, to avoid breakage, handle must be reversed slightly as tool is swung over, whilst maintaining band tension. Cut band with cutter lever and slide tool off in same position (or tension will be lost).
4. Hammer ears down over cut band.

► Screw buckles

Screw buckles are used for the application of clamps in restricted areas, for temporary clamps and for other special applications where adjustments may be necessary. Set screws with specially designed tips are used to grip the band within the buckles. All screw buckles are packed in boxes of 25 complete with set screws and Allen key.



▼ Screw buckle application

1. Apply band and screw buckle to object as described for regular buckles.
2. Tension in normal way, but do not move tool in arc to fold band over buckle.
3. Insert set screw into buckle and tighten with Allen key to secure band. Press cutter blade handle down to cut band.
4. Complete clamp by folding stub into buckle. To allow for re-use of clamp or any adjustment to tension, a 100mm stub should be left.

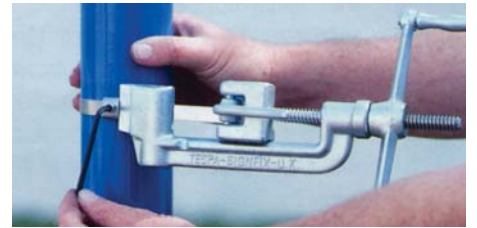
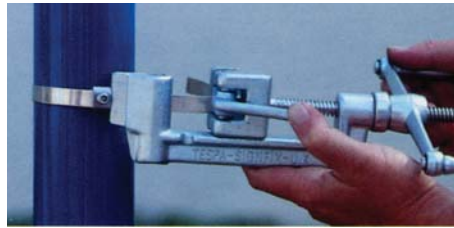
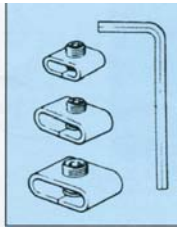

◀ Universal channel clamps

Two universal channel clamp products are offered for fixing all types and sizes of sign that incorporate channel sections to the rear. The clamps slide into the extruded channel sections and then accept stainless steel band to facilitate the fixing of the sign to any size or shape of post, pole or column.

▼ 1-Piece universal channel clamp

This highly versatile fixing will operate with band up to 19mm (3/4") wide. As the band is tightened, its tensioned spring design locks it solidly in place, preventing any sideways movement.

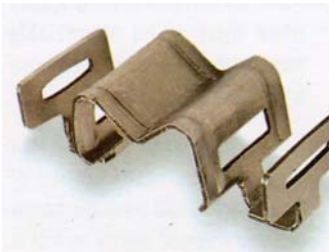

► 2-Piece universal channel clamp

The original two-piece design features a saddle that slides into the channel. Accepts all bands up to 19mm (3/4") and as the band tightens the saddle clamps tightly against the channel holding the sign securely in place.



► Junior channel clamp

The Junior channel clamp operates on a similar principle to its Universal big brother and provides sign erectors with an inexpensive, adaptable one-piece fitting for small timeplate and dog fouling signs. The clamp should only be used in conjunction with Junior bucklestraps utilising a suitable band or 7mm screwband. The design permits mounting onto any size or shape of pole or post, within the scope and limitations of the Junior bucklestraps.

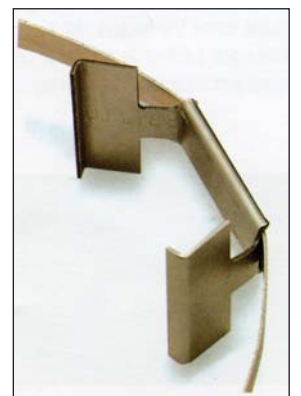

► Offset Bracketry, Post Accessories, Cutouts

Street Furnishings bracketry

- A series of interchangeable components form a wide range of tubular offset brackets to suit selected site conditions for mounting illuminated or non-illuminated signs
- The kit parts can be simply and rapidly assembled to form a neat strong bracket
- A minimum outlay of capital provides a stock of parts which will assemble into a bracket to suit almost every situation
- Any assembly can be dismantled and reassembled in a different form to suit altered site conditions
- All components plascoated grey or hot dip galvanised to BS729
- All bracketry can be plascoated black on request

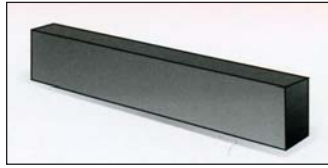

◀ Crossarm

Forms the horizontal offset between any two Streetset components shown.
Specification: 50x25x2.5mm rectangular hollow section drilled and tapped to accept two M10 s/s socket set screws to secure it over the pre-drilled spigots fitted to the Streetset components fitted at each end of the Crossarm.
 B2/OB/02 300mm long; B2/OB/03 450mm long; B2/OB/04 600mm long; B2/OB/05 750mm long



◀ Wall/lamp column plate

Secures Crossarm of selected length to walls or polygonal columns.
Specification: A radiused M.S. plate having four 10mm stainless steel corner steadies and a 12mm diameter hole above and below the Crossarm spigot. The corner steadies retain and tension the stainless steel banding used to clamp the plate to a polygonal column and allow for levelling of the Crossarm on tapered columns. They also take up unevenness in a wall surface when the plate is mounted by wall fixing bolts through the 12mm diameter holes. B2/OB/06



◀ Circular column plate

Secures Crossarm of selected length to circular hollow columns of 89, 114 and 139mm o.d. using stainless steel banding or cartridge tool (e.g. Hilti).
Specification: Small upstands above and below spigot retain the stainless steel banding on the plate. The accurately radiused plate allows direct fixing to a steel column by cartridge tool.
 B2/OB/20 for 89mm o.d. column; B2/OB/21 for 114mm o.d. column; B2/OB/22 for 140mm o.d. column



◀ Mid post sleeve mounting

Secures Crossarm at selected height below top of 76mm o.d. supporting post. Holds selected length of 76mm o.d. tube above and below end of Crossarm to form backpost for sign attachment.
Specification: 120x89x4mm M.S. tube. Diametrically opposite the mid height Crossarm spigot are two 10mm stainless steel screws (to lock it into the 76mm tube) and a 12mm diameter draw wire hole. B2/OB/07



◀ Socket mounting for box sign

Mounts a socket mounted internally illuminated box sign at the end of the Crossarm.
Specification: 230x76x3mm M.S. tube with Crossarm spigot 25mm from bottom of tube. Supplied with drive-in post cap to close bottom end of tube. B2/OB/08



◀ Single post-top mounting

Secures Crossarm from top of 76mm post. Holds selected length of 76mm tube to form backpost above Crossarm.
Specification: 230x76x3mm M.S. tube with Crossarm spigot 25mm from top of tube and Streetjoint fitted at lower end to lock it into 76mm post. Supplied with drive-in post cap to close top end of tube. B2/OB/08HJ

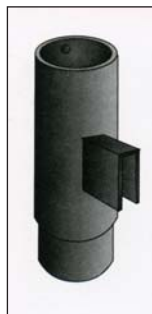

◀ Lower post-top mounting

Positioned below B2/OB/08HJ on top of 76mm post it allows two signs to be offset at different angles from the same post.
Specification: 230x76x3mm M.S. tube with Crossarm spigot centrally mounted and Streetjoint fitted at lower end to lock into 76mm post. B2/OB/09



◀ Top or mid post sleeve mounting

Secures Crossarm to top of 76mm post more cheaply but less elegantly than B2/OB/08HJ. If spring dowel pin is removed it can be slid down the post and used as B2/OB/07 (but has no draw wire hole). Pairs with itself to support selected length of 76mm back post.
Specification: 150x89x4mm M.S. tube. Diametrically opposite the Crossarm spigot (fitted 25mm from top of tube) are two 10mm stainless steel screws (to lock it to 76mm tube) and spring dowel pin to rest on top of 76mm post so that cable entry to Crossarm is above post. B2/OB/10



◀ Twin post-top mounting

Allows two signs to be mounted in angled back-to-back relationship at top of 76mm post. Used beneath post extension on top of 76mm post and with B2/OB/08 at ends of Crossarms, it allows yellow Pedestrian Crossing Beacons to be mounted below white centre island Column Beacon.
Specification: As for B2/OB/08HJ but having two diametrically opposed Crossarm spigots. B2/OB/11



◀ Upstanding backpost

Choice of appropriate length will hold back-mounted signs above Crossarm and so keep the necessary height of supporting post to a minimum.

Specification: 76.3mm o.d. tube with Crossarm spigot welded 25mm from bottom. Supplied with drive-in post caps for top and bottom of tube.
 B2/OB/12 450mm long; B2/OB/13 600mm long;
 B2/OB/14 750mm long; B2/OB/15 900mm long

Streetjoint key

This special tool for tightening Streetjoints is designed for the operator to obtain approximately 8M/Kg torque when applying maximum possible force by hand. MS/HJK



◀ Centre mounted backpost

Choice of appropriate length will hold back-mounted signs equally above and below Crossarm. Better balanced and better looking than the Upstanding Backpost, this unit may require the supporting post to be longer to maintain ground clearance beneath sign.

Specification: As for Upstanding Backpost but with Crossarm spigot centrally mounted.
 B2/OB/16 450mm long; B2/OB/17 600mm long;
 B2/OB/18 750mm long; B2/OB/19 900mm long

▼ Examples of offset bracketry assemblies

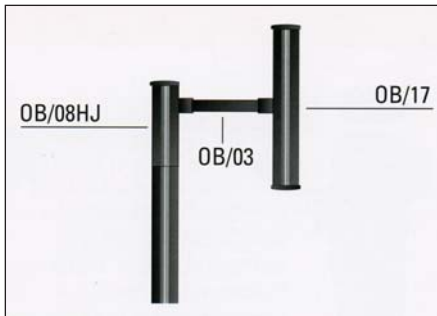

530mm offset and 600mm backpost (centre mounted) for back-mounted signs.

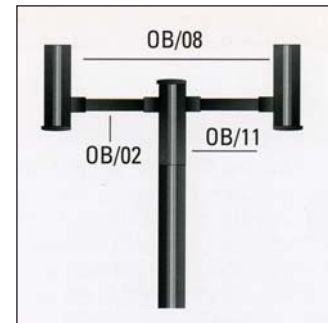

Suitable for angled back-to-back mounting of two socket-mounted box signs.

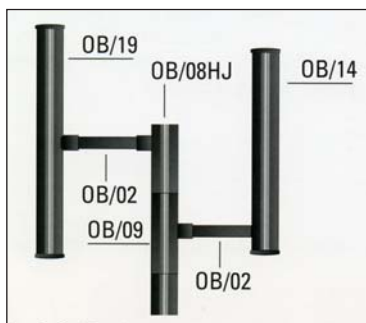

Method of offsetting back-mounted signs of different heights at different angles using available bracketry

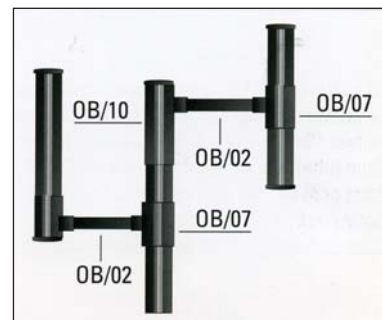

Method of offsetting back-mounted signs of different heights at different angles (using 76mm o.d. tubular offcuts for sign backpost).



Streetset bracketry can be built up into braced assemblies for large area or heavy signs and for signs mounted on longer than usual outreach for which special lengths of Crossarm can be supplied to order.

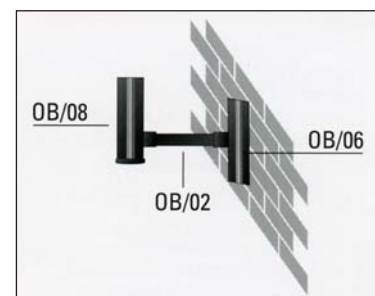

Suitable for socket mounted sign extended 355mm from wall (to centre of sign) to which it is attached by Rag Bolt, Rawbolt, Hilti equipment, etc.

► Offset Bracketry, Post Accessories, Cutouts *(continued)*

▼ Post extension

- 1 metre x 76mm internal fix
- Grey finish
- Other sizes available to order



▼ Offset bracket arm

- 76/76mm 450mm offset
- Tespa fix/Wall fix 450mm offset
- Accepts 76mm tubing up to 1 metre length



◀ Titan cutout

The Titan cutout has many unique features for a compact unit of this size. The Titan range provides improved flexibility and will be the only unit available to achieve the extensive range of terminations required by the installer and has been designed with a Cam Lever handle that ensures easy removal of the fuse carrier. This robust unit has been designed and manufactured to withstand heavy use in demanding locations. The Titan range provides increased access to allow easier cabling for incoming terminations because of its clear access gear tray and external fixing screws.

Specification:

- Max rating 25A
- Height 155mm Width 90mm Depth 65mm
- Designed, manufactured and tested in accordance with BS7654 and IEC 947 Part 1
- Accepts fuses to IEC 269-1 and BS 88 Part 1, AC16 Tag type
- Moulded in high performance thermoplastics to meet BS 7654
- Single pole or double pole
- Single fuse or twin fuses
- Clear access gear tray for enhanced terminations (external fixing screws)
- Terminal blocks to accept circular conductors up to 25mm CSA
- Terminal blocks can accept 1 to 3 conductors
- Terminal blocks available with studs for lug connections
- Terminal blocks have serrated bores to ensure good contact with all conductor types
- Terminal block cover moulded in red thermoplastic for safety
- Cable entry plates available in plastic or brass
- Plastic cable entry plates accept 3 grommets 2x25mm + 1x20mm diameter
- A sealing wire facility is provided
- A padlock facility for safe working
- A captive screw secures the cam lever handle
- IP23D rating

► Globes & Galleries

▼ Galleries & lampholders

- Available in grey or black
- Fixes to 76mm post
- Brass anti-vibration bayonet fix
- Accepts Belisha beacon/CIC globe



▼ Belisha Beacon

300mm diameter one piece.













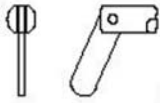



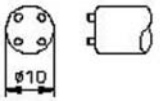



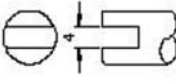

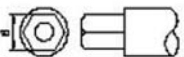

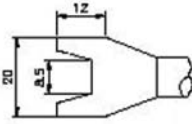



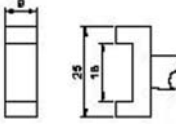



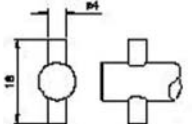







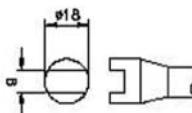

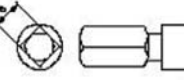

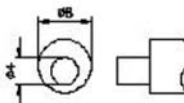

▼ CIC globe

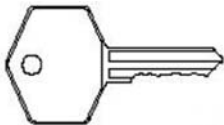
300mm diameter one piece.

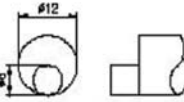

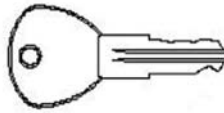
▼ Street Furnishings lighting keys

		<p>SF6002 Small tri head key 6mm. Uses: bollards, control panels, flasher units, etc.</p>			<p>SF6007 Drop latch key. Uses: drop latch door locks.</p>
		<p>SF6020 Standard tri head key 8mm. Uses: 8mm tri head screws, bolts, locks, etc.</p>			<p>SF6024 Design plan type screwdriver key. Uses: design plan type screws.</p>
		<p>SF6004 Large tri head key 10mm. Uses: 10mm tri head screws, bolts, locks, etc.</p>			<p>SF6008 Slotted key for Eleco type columns. Uses: Eleco type column door locks.</p>
		<p>SF6022 Small 6mm AIF anti vandal key. Uses: 6mm AIF anti vandal bolts, locks, screws, etc.</p>			<p>SF6006 Two prong spade key. Uses: Revo type brass head bolt.</p>
		<p>SF6036 Medium 8mm AIF anti vandal key. Uses: 8mm AIF anti vandal bolts, locks, screws, etc; PDE AIV pillar locks</p>			<p>SF6023 Stewart & Lloyd type key. Uses: Stewart & Lloyd type column door locks.</p>
		<p>SF6021 Large 10mm AIF anti vandal key. Uses: 10mm AIF anti vandal bolts, locks, screws, etc; PDE AIV pillar locks</p>			<p>SF6017 Two prong key. Uses: two prong key locks.</p>
		<p>SF6001 Lucy & GEC type key Uses: 1/4 turn lock assemblies, Lucy & GEC type locks</p>			<p>SF6061 1/2" square key. Uses: square door locks.</p>
		<p>SF6005 Tapered square drive key (or Carriage) from 1/4" AIF (6mm) to 3/8" AIF (9mm). Uses: Square drive locks or slam locks.</p>			<p>SF6063 Traffic controller cabinet key. Uses: traffic control cabinets and pelican crossings.</p>
		<p>SF6016 Shouldered square drive key. Uses: square drive locks.</p>			<p>SF6062 Key ring tri head key. Uses: 8mm tri head screws, bolts, locks, etc.</p>
		<p>SF6015 Thorn type offset pin key. Uses: Thorn type offset pin door locks.</p>			<p>SF6009 Stanton & Staveley type key. Uses: Stanton & Staveley type column doors.</p>
		<p>SF6028 Offset subway door pin key.</p>			<p>SF6011 GEC type column key. Uses: GEC type column doors.</p>



◀ 4-Way key options

- SF6039: Consists of keys SF6020, SF6004, SF6007, SF 6023
- SF6065: Consists of keys SF6022, SF6036, SF6021, SF6004
- SF6042: Consists of keys SF6006, SF6016, SF6020, SF6036

Key sets

- SF6030: Full set of all keys shown above
- SF6027: Street lighting key set ■ above
- SF6035: Traffic products key set ■ above

► Signlight Units

► Type A light unit

- Light unit complies with Chapter 11 Traffic Signs Manual BS873 Part 5
- Units designed to illuminate signs of up to 750mm diameter
- Die cast aluminium alloy body for lightness and strength
- 2x8 lighting configuration
- Comes complete with photocell 70lux
- Grey finish - black also available

Arms available:

- 76mm, 89mm or 114mm post top
- 76mm, 89mm or 114mm clamp on
- Tespa fix bracket arm



► Type A2 light unit

- Designed to comply with Category 2
- Able to illuminate signs with supplementary plates
- 2 x 11W lighting independently fused
- No visible external fixings
- High vandal resistance, polycarbonate lens
- Grey finish - other colours available



► Service Boxes/Feeder Pillars

► Feeder pillars

Designed as robust and effective enclosures to provide electrical services for a variety of applications. The pillars incorporate a high level of corrosion proofing to ensure durability and a long maintenance-free life. Available in seven sizes to meet most applications for the smaller installation and available in two material finishes: a) sheet steel which is hot dip galvanised to BS 729 b) sheet steel which is hot dip galvanised to BS 729 and then treated and painted as standard in grey.

Specification:

- Pillars have a fully removable door
- Two tri-head locks fitted as standard, anti vandal lock available
- Backboard from 18mm thick treated exterior grade plywood
- Danger warning label fitted in a recess in the door
- Earth lead connection supplied from pillar body to door
- High quality UV resistant paint to a minimum thickness of 60 microns
- Fixing bolts, nuts, washers and locks are all stainless steel
- Detachable roof
- Backboard can be removed for wiring

Options:

- May be supplied pre-wired with a fuse unit or isolator unit
- Other colours available to special order
- G2A Highways paint specification
- Different locking options available (Lucy locks, Yale locks, hasp and staple)
- Special labels to identify ownership

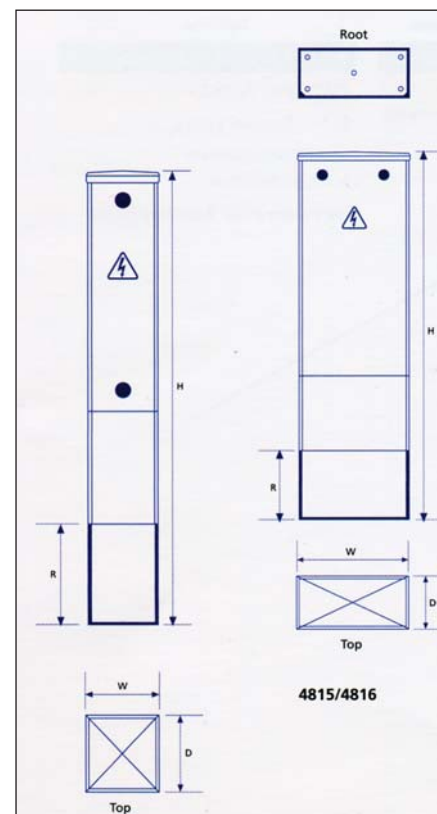

► Root box for post or wall mounting

This unique product is manufactured in one size with two versions to the highest quality and will offer long service even in exposed locations. 4800 Type A is a root box with a closed base, for mounting at the top of a column or post and for wall mounting, painted grey. 4800 Type B is a root box with an open base, for mounting at the base of a column or post, painted grey.

Specification:

- Manufactured in 3mm aluminium
- Anodised prior to painting
- Powder coat painted in grey (BS 4800.18B25)
- High quality UV resistant paint to a minimum thickness of 60 microns
- Tri-head key wedge lock for added security
- Backboard from 18mm thick treated exterior grade plywood
- Danger warning label fitted in a recess in the door
- Earth lead connection supplied from body to door
- Door sealed to IP42 as standard
- Water-shedding cap

Options:

- May be supplied pre-wired with a fuse unit or isolator unit
- Other colours available to special order
- Special labels to identify ownership

Dimensions:

Height 720mm
 Width 180mm
 Depth 160mm
 Door height 460mm
 Working depth 110mm
 Backboard size 140 x 405mm
 Bracket diameter 80mm
 Weight 5kg

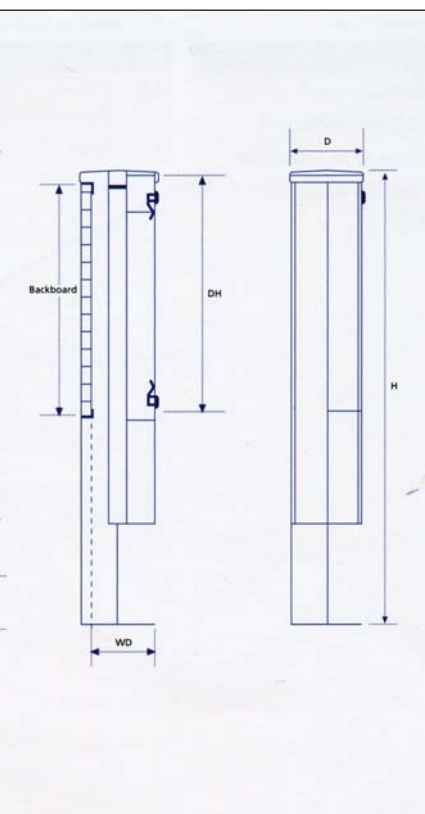
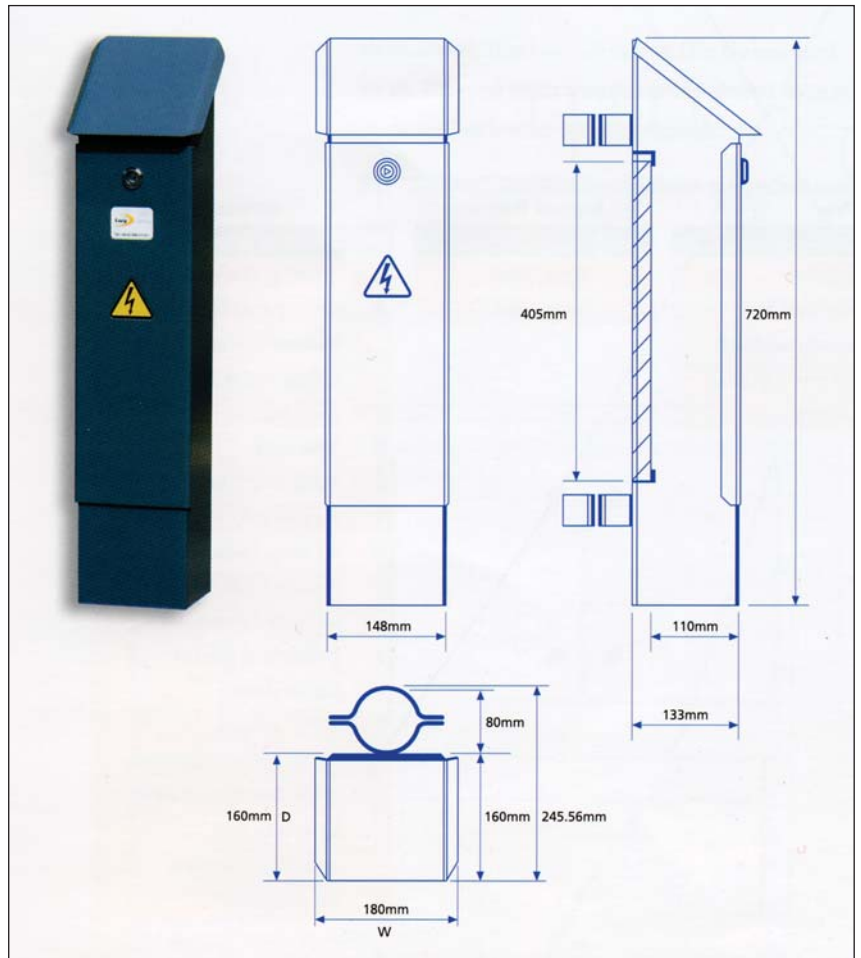

Feeder pillar options

Dimensions (mm)

Pillar size code	SF4810	SF4811	SF4812	SF4813	SF4814	SF4815	SF4816
Nominal size in inches (WxD)	4x4	6x4	6x6	8x6	10x6	14x6	19x10
Total height (H)	1010	1010	1010	1010	1010	1210	1300
Root section (R)	223	223	223	223	223	223	300
Width (W)	110	160	160	210	260	365	490
Depth (D)	120	120	170	170	170	170	250
Door opening height (DH)	490	490	490	490	490	690	780
Working depth (WD)	85	85	130	130	130	130	199
Backboard size (WxH)	90x500	140x500	140x500	190x500	240x500	345x710	480x790
Weight (Kg)	11	14	16	19	22	32	47

► Illuminated Zebra Crossings & Centre Islands

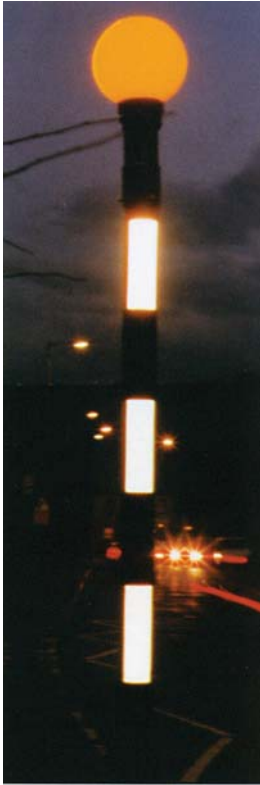

◀ Illuminated zebra post

Available options:

SF-ZEB4-CDM:
4 band CDM assembly post 4.3 OAL (600pd)

SF-ZEB3-CDM:
3 band CDM assembly post 3.7 OAL (600pd)

SF-ZEB2-CDM:
2 band CDM assembly post 3.3 OAL (600pd)

Specification:

Mild steel post, galvanised to BS729, polyester powder coated black with integrated translucent vandal resistant poly inner tube for internal illumination.

CDM light assembly, PAR30L CDM lamp, tungsten halogen flasher and lamp, black 114mm gallery housed in Stayfix anti-vandal yellow globe assembly.

Post 168mm base, 114mm upper section.

► Pedestrian crossing post

Available options:

SF-PDA-43:
4 band pedestrian crossing post 4.3 OAL (600pd)

SF-PDA-37:
3 band pedestrian crossing post 3.7 OAL (600pd)

Combination assemblies also available.

Specification:

Standard pedestrian crossing post - mild steel galvanised to BS729 post, PVC coated black c/w Class I reflective bands. Post 140mm base, 76mm upper section.



Products conform to current BS Standards.

► Floodlight combination assembly

SF-ZEB4/FL-6.9
Floodlight/4 band ZebraSafe combination assembly OAL 6.9M (900pd)

Standard pedestrian post versions available.

In addition to the standard pedestrian crossing and centre island refuge combination assemblies, Street Furnishings offer the full range of crossing equipment to bring a truly flexible product design to meet its customers' application needs.

Specification:

The ZebraSafe Floodlight Combination assembly comprises 4 band ZebraSafe post with galvanised (BS729) top extension post (painted options available), 114mm single clamp round bracket. The CDM assembly is supplied c/w tungsten halogen flasher and lamp, black gallery, housed in Stayfix yellow globe arrangement. LED option available. Included is a 114mm to 76mm spigot (reducer) as standard. Floodlights supplied as extra over to customer specification.



▶ CentreSafe & standard centre island refuge assemblies

Available options:

SF-CI-44-POST	Standard post 4.4M OAL (600pd)
SF-CI-47-POST	Standard post 4.7M OAL (600pd)
SF-CI-58-POST	Standard post 5.8M OAL (900pd)
SF-CI-SAFE44	CentreSafe complete assembly 4.4m OAL (600pd)
SF-CI-SAFE58	CentreSafe complete assembly 5.8m OAL (900pd)
SF-CI-SAFE-H	CentreSafe - Post length made to specification - Hinged type
SF-CI-SAFE-BA	CentreSafe frangible unit - Post length made to customer specification
SF-CI-CONV12	CentreSafe conversion post 1.2M for fixing to standard 76mm post

Specification:

CentreSafe comprises: mild steel post, galvanised to BS729, polyester powder coated grey with two integrated translucent vandal resistant poly inner tube for internal illuminated. Complete CDM assembly c/w Stayfix anti-vandal globe unit. Globe illumination 1 x PL11W gear and lamp or LED option. 168mm base, 114mm upper section.



◀ ZebraSafe/CentreSafe CDM combination assembly

Available options:

SF-ZEB4/CI	4 band CDM ZebraSafe with standard centre island top section
SF-ZEB4/CIS	4 band CDM ZebraSafe with CentreSafe top section

Above supplied as 168mm base with 114mm upper section post OAL 6.9M (900pd)

SF-PDA4/CI	4 band standard post with standard centre island top section post OAL 6.9M (900pd)
------------	--

Above supplied as 140mm base with 76mm upper section

Units as supplied with double beacon bracket full assembly comprising Stayfix unit.



► Lighting Columns & Street Lighting

◀ Streetfighter luminaires

Versatile road lighting luminaires in modern style. Quality lighting for safe and comfortable driving, and for area illumination, with low investment and maintenance costs. Vandal resistant.

Main applications:

- Industrial areas
- Residential areas
- Rural roads
- Minor roads
- Car parks

Suitable lamp types:

- SON-T 50/70 W

Features:

- Optical system designed for good beam control and light output
- Flexible mounting capability, with side entry or post top mounting with 34 and 76mm mounting units
- Vandal-resistant polycarbonate bowl
- Models with NEMA socket for photocell switching available on request
- Sturdy construction resistant to water and dust. Class II insulation provides extra safety
- East installation. Hinged bowl with quick-release clips and removable rear canopy allow swift, safe maintenance

Materials & finish:

Canopy in glass-fibre reinforced UV-stabilized polypropylene in light grey; polycarbonate bowl; mounting module in non-corrosive, diecast aluminium; gear carrier in glass-fibre reinforced polycarbonate.

Installation:

Side entry 34mm post top and 76mm mounting units are available.

▼ Lighting column diagram

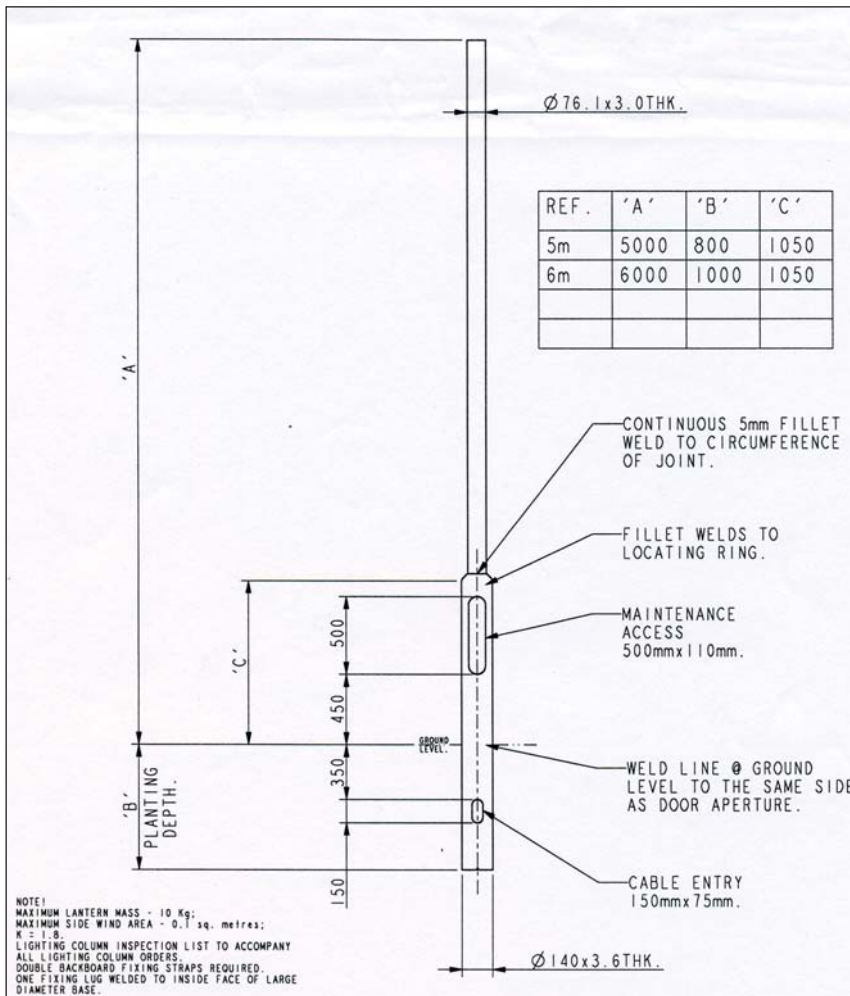

▲ Post-top mounting



▲ Side entry mounting

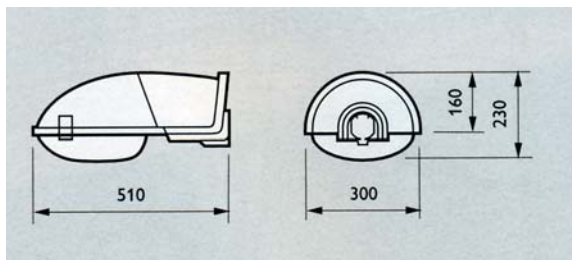



◀ Flat top bollard

- Classical slim line design
- Robust aluminium construction
- High performance polycarbonate refractive lens
- Fused cut-out with SWA cable terminations
- Large access door for easy installation
- Wide range of colour finishes available
- Finished in grey as standard

Lamp options:

- 50W SON-E/I (internal ignitor) - E27 cap
- 50W MBFU Deluxe - E27 cap
- 9W TC-S compact fluorescent, 4000oK - G23 cap
- 100W (max) GLS - E27 cap

Materials:

- Head - pressure die cast aluminium, multi-stage chromate pre-treatment, powder coated in grey finish
- Body - extruded aluminium, multi-stage chromate pre-treatment, powder coated in grey finish
- Lens - clear polycarbonate prismatic refractor

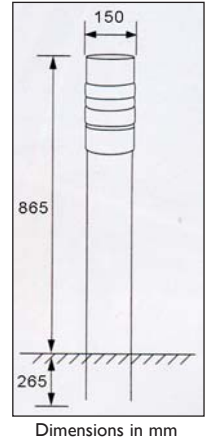

Photometric data:

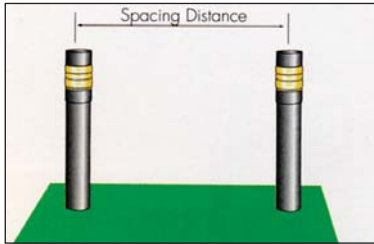

Cat No.	Spacing distance to achieve typical mid-point illuminance				
	15 lux	10 lux	5 lux	2 lux	1 lux
CBSE50	3.0m	5.5m	7.0m	9.0m	12.0m
CBME50	3.0m	5.0m	6.0m	8.0m	10.0m
CBCT209	3.0m	4.0m	5.0m	7.0m	8.0m
CBGE100	3.0m	4.0m	5.0m	7.0m	8.0m

▼ Dome top bollard

- For use in pathways, walkways, urban spaces, piazzas
- Robust, complies with BS EN 60598 - good value and available in two sizes
- IP65 - very good protection against weather for a long reliable life
- Extruded aluminium housing - tough and durable with a very weather resistant black powder coated finish
- Vandal resistant diffuser - the clear ribbed UV-

resistant polycarbonate diffuser will withstand rough treatment

- Versatility in lamp choice - the wide range of lamp types accommodated makes for a very versatile luminaire
- Choice of bases - the zinc coated base plate is standard but a root mounted version is available for greater strength
- Range of options - including a 3-hour integral emergency version, photocell control and a white housing

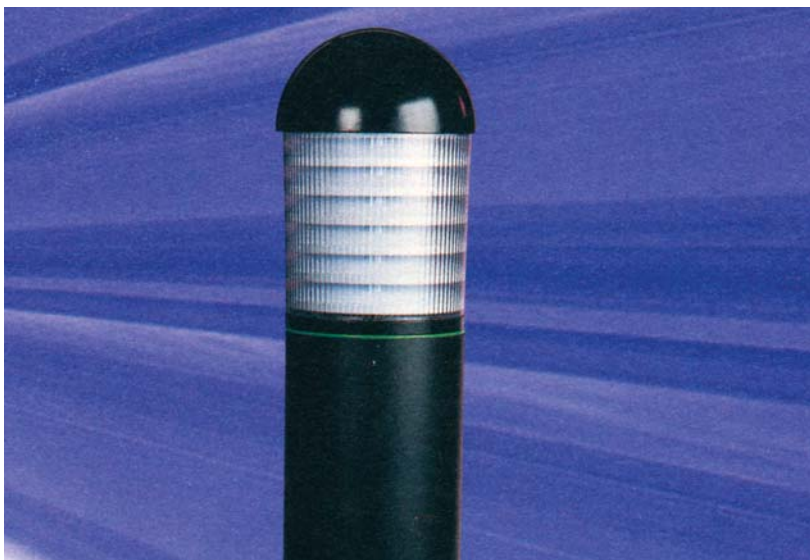
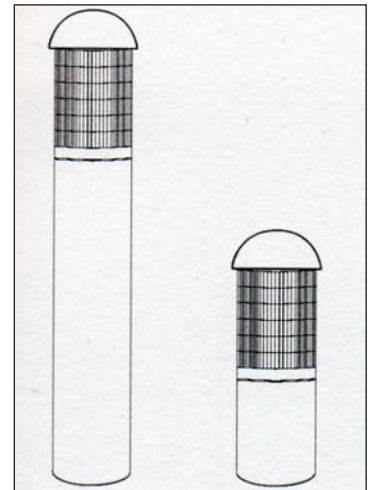

Technical data:

- Two body sizes - available in 500mm and 1100mm heights, extruded aluminium
- Finish - black powder coated as standard
- Lamp types - 70W SON, 80W and 125W MBF/U and 2 x 18W TCD/CFL

Dimensions:

Type	Height mm	Diameter mm	Weight Kg
500	500	180	5.8
1100	1100	180	8.5

► Baselit Bollards



▲ Ecco shell (flexible)

- Economy bodyshell 270
- Complete with stainless steel bolt fixing & nylon bushes
- Single aspect

▲ Reflex shell (flexible)

- Reflex bodyshell 270
- Complete with stainless steel pins
- Single aspect

▲ MDP shell (rigid)

- MDP rigid bodyshell 270
- Complete with nylon fixing pins
- Single aspect



▲ Safelite 600 MDP (rigid)

- Safelite 600 MDP rigid shell
- Complete with nylon fixing pins
- Single aspect

▲ Safelite 600 (flexible)

- Safelite 600 reflex shell
- Complete with stainless steel fixing pins
- Single aspect

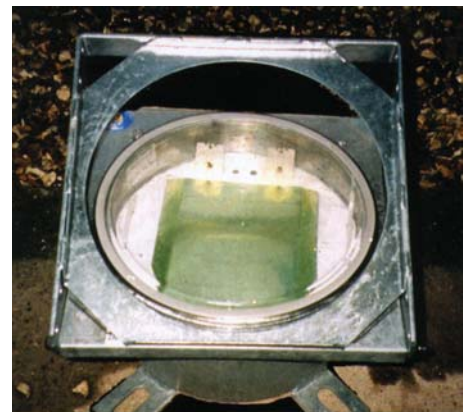

◀ Basebox 19C

- 2 x 11 watt c/w lamps
- Lead tubes as standard
- Gland fitting available

▶ Basebox 19D

- For use with Safelite shells.
- 3 x 11 watt c/w lamps
- Lead tubes as standard
- Gland fitting available



▲ PDGI bollard base

- 2 x 11W c/w lamps
- Domed polycarbonate lid
- One-piece heavy duty spun cannister
- Designed to meet IP67
- Variations on cable entry glands or turrets
- Easily removable gear tray
- Stainless steel hinged pivot frame
- Available 3 x 11W format
- Quick release version available
- Base completely galvanised to BS729
- Competitively priced

► ▼ Range of internally illuminated box signs

Street Furnishings offers the most versatile range of internally illuminated box signs available in the UK market, manufactured to meet current regulatory standards for use on UK roads and highways, other designs are readily available such as those used at airports and for commercial use.

- Up to 750mm - tough polyethylene available as standard grey or black (white interior)
- Over 750mm - extruded aluminium - powder coated, grey as standard, other colours available (white interior)
- All illuminated units can be wall mounted, back or post top fixing

Options include:

- Lower window to illuminate supplementary signage
- Inspection window
- Photocell
- Vandal resistant bonded rim c/w tamper proof fasteners

Specification:

Box unit: available as single or double sided

Rim: moulded flange inside the outer edge provides extra security

Panel: polycarbonate laid with 3M diamond grade material, 12-year reflective guarantee

Mounting: back fix (extruded aluminium channel section), post top (cast aluminium)

Fixings: stainless steel

Gear tray: independently fused with power correction factor as standard 7W, 8W, 13W, 15W and LED (configuration to suit box size lighting levels)



Customised designs:

Through our design service, Street Furnishings customers are offered advice on product selection and we are also able to supply alternative sizes and designs to meet customer needs.

Available units:

Polyethylene body

Complete anti-vandal box sign (triangle) - available as 450mm, 600mm or 750mm

Complete anti-vandal box sign (circle) - available as 450mm, 600mm or 750mm

Complete anti-vandal box sign (rectangular) - 300 x 450mm

Complete anti-vandal box sign (octagonal) - 750mm

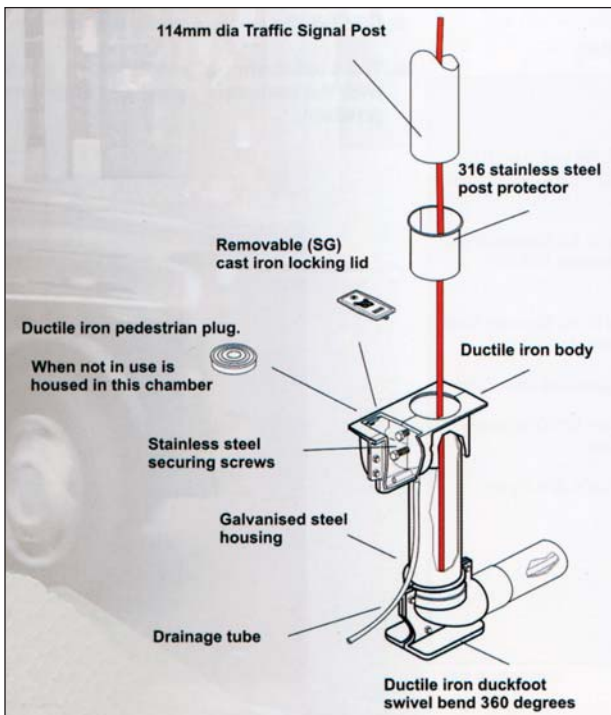

◀ ▼ SF-RSI 15DF retention socket

Modular in construction consisting of a spheroidal graphite cast iron body, lid, pedestrian plug and duckfoot bend, together with a galvanised steel central housing. Available in long or short depths to suit specifier's requirements (as shallow as 366mm with 90 degree rotation either side of main body). All other depths have 360 degree rotation.

The SF-RSI 15DF retention socket eliminates the need for costly and disruptive excavations after knockdowns, allowing posts to be removed and replaced in minutes.

- Simplifies and separates civils and electrical works
- Easily installed in shallow and congested footways
- Addresses Health & Safety installation issues
- Easy reinstatement of knockdown sites
- Cost-effective
- Also available for 60, 76 and 89mm posts



► School Patrol Flasher Units

► TwinFlash unit

- Manufactured to BS 873
- Fully conforms to the requirements of the Low Voltage Directive 73/23/EEC with reference to BS EN 60598-1:1997
- Fully conforms to EMC Emissions - BS EN 55014-1:2001
- Powered by 240V AC mains electricity (alternative voltages available on request)
- Low power consumption - 5 watt 20 ma
- Remote control operation using radio controlled sensor
- Supplied with 6m cable

Body:

- Tough vandal resistant housing made from a single high density polyethylene moulding
- UV stabilised
- UL94 fire retardant test
- Fixed to various sizes of posts by means of sign-fix brackets
- Vertical or horizontal fitting option

Lens pods:

- LED light source - selected for high light output
- Low maintenance - greater than 100,000 hour life expectancy
- 2 x sealed pods with 12 self-coloured LEDs
- Optically designed to maximise light output
- Vandal resistant polycarbonate lens



► MicroTima programmable controller

Use TwinFlash with MicroTima's programmable series 5 controller.

- Automatic flasher operation for up to a year ahead on the days you want at the times you want
- Accurate and reliable timekeeping
- Easy Windows® programming from PC or PDA - with free software
- Wireless programming available
- More switch tables and more switching times
- Mains or DC power supply
- Upgradeable - future-proof your investment



► Safer Routes to School signs - timer activated

In response to the government's Safer Routes to School initiative, a range of signs is available specifically designed for use on busy roads in the vicinity of schools and other pedestrian zones. UK records show that the highest proportion of child pedestrian casualties linked to road accidents occurs during the school journey.



Display formats

The vehicle and timer activated signs present a range of coloured text and pictograms, programmed to suit the requirements of a specific application. The display options include text, simple warning lights, and pictograms - or any combination of these formats.

Activation

Timer activated signs operate during pre-set hours, for example, to coincide with school opening and closing times. Speed warning sign activation is triggered by vehicle detection using above-ground microwave detectors, or by induction loops buried beneath the road surface.

LED optics

The LEDs at the heart of the signs are fully proven and tested over many years of use in a variety of applications. The modules are specifically designed for low power consumption, with a typical life expectancy of 100,000 hours (normal filament bulbs are rated at only 3,000 hours).

Power source

As standard, the signs are powered by mains supply. However, battery, solar and wind power options are available.

Data logging

The detection systems also present an option to monitor traffic flow and vehicle speed, providing data for detailed analysis.



◀ Speed warning signs - vehicle activated

A range of vehicle activated speed warning signs is available to warn drivers of speed and hazards. Various options are available to suit all requirements.

◀ Timer Group 3 Type I Safer Routes sign

Fixed 'school sign, school & 20mph when lights flash'.

Dimensions:

Width 975mm
Height 1780mm
Depth 28mm
Weight 23Kg



◀ VAS Group 5 Small speed sign

Vehicle activated sign. Options of a speed roundel or SLOW DOWN and speed roundels up to 450mm diameter.

Dimensions:

Width 600mm
Height 800mm
Depth 28mm
Weight 12Kg



◀ VAS Group 5/6 Mid-size speed sign

Vehicle activated sign. Typically 600mm diameter (red triangle sign e.g. crossroads or red speed roundel), without additional text.

Dimensions:

Width 1000mm
Height 1000mm
Depth 28mm
Weight 25Kg



◀ VAS Group 6 Mid-size warning sign

Vehicle activated sign. Typically 600mm diameter (red triangle sign e.g. crossroads or red speed roundel) with SLOW DOWN characters up to 150mm high.

Dimensions:

Width 1000mm
Height 1500mm
Depth 28mm
Weight 30Kg



► Island Sites

► Centre island site

These prefabricated frames, or 'D-Rings', provide an economical method of forming a centre island refuge on an existing single carriageway. Unlike concrete kerbs, they require no excavation, but are simply ragbolted to the existing road surface and backfilled with concrete. For temporary sites, a filling of ballast with a top layer of tarmac can be used.

The frames can be supplied with anchor plates only, or as an extra, with a bollard base mounting frame. Another option to simplify installation further is to have the Groundlight base or Knockdown base supplied factory fitted.

Island sites are formed in the shapes illustrated and are of welded construction. The 900mm triangle and 'D' type frames are supplied as one-piece only; the larger triangles are available in segments for bolting together on site, or as one piece.

- Prefabricated, ready to install
- An economical way to form a centre island refuge
- Minimum excavation required
- Adaptable

Material:

130mm deep x 6mm thick mild steel frame with 50mm x 6mm anchor plates.

Finish:

Primed in red oxide paint.

Options:

Ragbolts are available if required. Can be fitted with a bollard base mounting frame.

'D' type sizes available (mm)			
	A	B	RAD
750	750	750	375
900	900	900	450
1200	1200	1200	600
1500	1500	1500	750

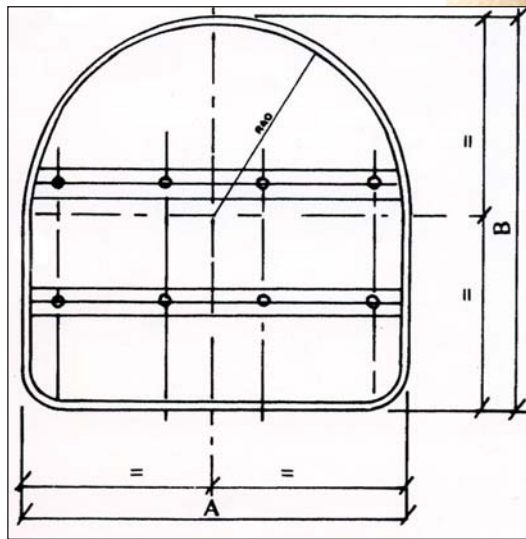

► Catseyes



◀ Long type Catseye

This base affords excellent protection to the rubber insert and is specifically designed for roads carrying heavy traffic or subject to snow ploughing. Only original Catseyes incorporate patented wear grooves which indicate when renewal of the base is required.

► Short type Catseye

This model is intended for use on roads with an AADT of less than 5,000 for single carriageway or 10,000 for dual carriageway and free from snow ploughing. The design ensures that the reflectors are well above the surface, thus clear of the surface debris and that less vehicle impacts initiate the self-wiping action.





◀ **Catseye inserts**

Inserts are easily and speedily replaced with the minimum of labour requirements. The insert is of highly resilient rubber. The life expectancy varies with traffic conditions. Recent approved modifications have extended life expectancies.

Highly efficient reflecting lenses are housed in a resilient rubber insert which clips into a patented metal base provided with ramps to protect the insert. The self-wiping action is automatically performed by vehicle tyres depressing the centre part of the rubber insert causing the reflectors to be wiped against the outer stationary wiper parts of the insert. The same rubber insert fits both Long and Short tpe bases. The studs are embedded into the road surface, therefore installation is permanent. Full instructions regarding installation are available on request.

- Clearly indicate the direction of travel
- Allow traffic to be regimented or laned
- Reduce driver fatigue
- By night and in fog when other roadmarkings fade, Catseyes shine to lead the way

Road Studs & Tactile Studs ◀



▲ **Stainless steel tactile studs**



▲ **Brass tactile studs**



▲ **Brass boundary studs**

▶ **Stainless steel roadstuds**

Each stud is made from austenitic stainless steel (18% chrome, 8% nickel) specially heat treated which ensures maximum toughness, strength and rust resistance. Available with either fishtail or chisel shank designed and shaped to prevent twisting after installation. To assist skid resistance a serrated face is also available (chisel shank only). A superior quality roadstud appropriate for any type of road surface, its durability provides excellent cost effectiveness.

▶ **Aluminium roadstuds**

Each stud is cast from aluminium alloy conforming to BS1490:1988. Supplied with a raised profile to assist skid resistance and fishtail shank. Suitable for most road surfaces - a cheaper short-term alternative to the stainless steel type when a compromise on quality is a necessity.

All studs conform to BS873 Part 4.



Measurements, types & weights						
Surface of stud				Shank of stud	Nett weight (approx)	
Metal	Head shape	Nominal measurements mm	Type		Shape	mm
Stainless Steel	Square	100x100	Plain face	Chisel	70±6	700
Stainless Steel	Square	100x100	Plain face	Fishtail	70±6	700
Stainless Steel	Square	100x100	Serrated face	Chisel	70±6	700
Aluminium	Square	100x100	Raised profile	Fishtail	70±6	210

➤ Allegrini Marker Posts



▲ ▶ Allegrini verge post

The traditional verge post made from hollow plastic with a 'solid' look. All the posts are suitable for installation in concrete, asphalt or soil. Visually compatible, they blend with existing posts in any situation. The long life of all the posts makes them economical with the added bonus of a proven record for all-round safety.

- Designed and manufactured to the highest specification
- Quick and simple to install
- Clearly visible by day or night and in bad weather conditions
- Highly durable plastic has special additive giving resistance to UV radiation
- These cylindrical posts are self-cleaning in wet weather - which ensures reduced maintenance
- Can be used anywhere - from trunk roads to car parks
- Cost-effective, lightweight, rust and rot proof
- In the event of impact, Allegrini has no sharp edges and will not splinter or become a dangerous missile
- Class I reflectors in red and white
- Packed in bags of 10

Specification:

Height	130cm
Weight	1.8Kg
Colour	Black and white
Reflectors	Red and white

➤ Flexible Verge Marker Posts

▶ Reflex Vergemarker

Affordable self-righting reflective plastic marker post. Non-corrosive, maintenance-free and recyclable. Shatter-proof angled reflectors. Highly visible white band on smooth 'non-clog' surface.

Popular uses:

Hazard marking in high risk locations.

Optional features:

Also available in rigid staked.

Fixing mechanism:

Surface and permanent

Materials:

UV stabilised moulded polyethylene (PE). Reflective bandings applied to aluminium carriers.

Colour range:

Black.

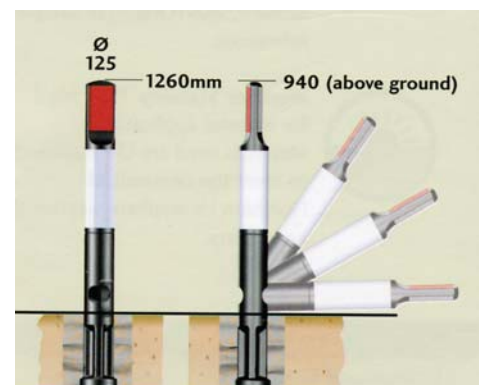

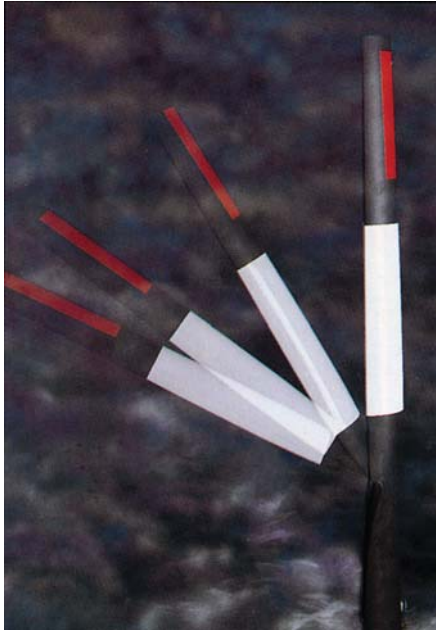

◀ Springbac

Manufactured from polypropylene modified with an Elastomer to provide excellent impact resistance even at very low temperatures. Installation could not be simpler - the only tool required for fixing is a hammer. Vehicle impact causes the post to flex fully before returning to the upright position.

Motorway & Trunk Road Marker Posts

Type of Post	Motorway Verge		Slip Road - (no numerals)		Central Reserve
		Countdown to emergency crossings	VERGE	OFFSIDE	Countdown to emergency crossings
<p>Socket Mounting Location</p> <p>Types 1, 2, 3: 300mm to 400mm outside hard shoulder / hard strip.</p> <p>Type 4 Offside: 300mm to 400mm outside carriageway.</p> <p>Type 4: Central Reserve on central line of centre reserve.</p> <p>Type 5: Centre line of centre reserve.</p>	<p>Type 1</p> <p>The most commonly used post</p>	<p>Type 3</p> <p>Countdown markers to crossings installed on both approaches to the crossing in place of type 1.</p>	<p>Type 2</p>	<p>Type 4</p> <p>This post is used on the central reserve when there is no crash barrier.</p>	<p>Type 5</p> <p>These posts are used in place of type 9 when there is no crash barrier.</p>
<p>Parapet/Tunnel Mounted (using adhesive)</p> <p>Location: 50mm below top of parapet.</p> <p>In tunnels etc, where verge mounted posts cannot be used, the post should be 450mm above verge level.</p>	<p>Type 6A</p>	<p>Type 7</p> <p>3 2 1</p>	<p>Type 6B</p>	<p>Type 6C</p>	
<p>Barrier Mounted Installed on safety fences with the bracket supplied not more than 1.5mm from the edge of the carriageway hard shoulder or hard strip.</p>	<p>Type 8B</p>	<p>Type 8A</p> <p>3 2 1</p>	<p>Type 8B</p>	<p>Type 8B</p>	
<p>Spacing</p> <p>All posts are positioned at 100m intervals.</p>	<p>Type 3(3), 7(3) and 8A(3), at 300m. Type 3(2), 7(2) and 8A(2) at 200m. Type 3(1), 7(1) and 8A(1) at 100m from crossing</p>				<p>Type 5(3), type 5(2) or type 5(1)</p>
	Near side (white posts)			Offside (no numerals blue posts)	

► Hydrant/Boundary Marker Posts

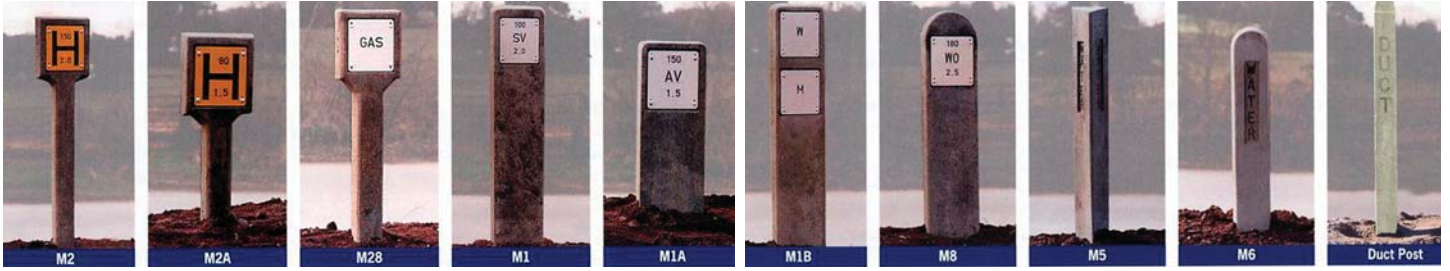

▲ Marker posts

Code	Description	Details
M2	Surrey Long Post	1370mm high x 75mm or 100mm deep with 240mm x 140mm base and 265mm x 240mm head and a recess to receive a marker plate.
M2A	Surrey Short Post	990mm high x 75mm or 100mm deep with 240mm x 140mm base and 265mm x 240mm head and a recess to receive a marker plate.
M28	Cathodic Protection Post	1220mm high x 150mm deep with a 305mm x 230mm head and a recess to receive a marker plate.
M1	Hereford Long Post	1370mm high x 230mm wide x 75mm deep. With a recess to receive one marker plate.
M1A	Hereford Short Post	915mm high x 230mm wide x 75mm deep. With a recess to receive one marker plate.
M1B	Hereford Double Post	1370mm high x 230mm wide x 75mm deep. With a recesses to receive two marker plates.
M8	Bristol Pattern Post	1220mm high x 230mm wide x 75mm deep with a recess to receive a marker plate
M5	Triangular Field Marker	1065mm high x 100mm triangular. Badged as required.
M6	Hedge Marker	915mm high x 75mm wide x 100mm deep. Badged as required.
Duct Post	Duct Marker Post	1525mm high x 100mm wide x 125mm deep. Badged as required.

► Marker plates

All the above recesses to receive standard marker plates 180mm x 205mm. Easy to mount direct to the post with push-in plastic fixings - no need for a backing plate.

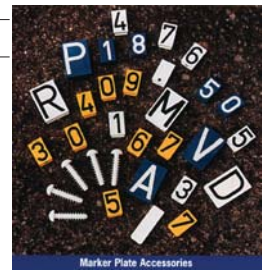

► Salt & Grit Bins

▼ Bee Hive bin

- Full 290o opening
- Capacity 8.8 CUFT (250 litres)
- Excellent nesting, perfect for summer storage

Dimensions:

Height (measured at back)	704mm
Depth (measured back to front)	600mm
Width	1050mm
Weight	15Kg





◀ Grit/salt bin

Moulded in tough polyethylene with a one piece fully integrated hinge arrangement. They are vandal resistant and completely rot proof. The lettering 'Grit' is embossed into the moulding providing permanent identification. Standard colour supplied is yellow. Non-standard colours, additional lettering or plates for personal identification can be fitted at extra cost. Drain holes are provided in the base.

Type	Capacity				Height		Depth		Width	
	ft ³	m ³	cwt	kg	ins	mm	ins	mm	ins	mm
A	6	0.17	4	204	28	712	26	661	26	661
B	12	0.34	8	407	30	762	28	712	32	813

Paint & Pre-Cut Road Markings



▲ Flexline rolls



◀ ▼ Flexline preformed thermoplastic road markings

- Wide range of colours
- Material can be formulated for hot or cold climates
- Can be laid easily onto coloured anti-skid surfacing
- Reflective glass beads can be applied during heating
- Black Flexline can be used to black out existing markings
- Ideally suited for maintaining existing markings



◀ Contractors spray paint

The contractor's answer to economic temporary marking.

- 728ml aerosol
- Temporary line and spot marker for low wear applications
- Fast drying



◀ Specialised logos & images

Maintenance paint

We are able to supply any BS colour paint for use in the maintenance of your highway products e.g. bollards, posts.

► Accessories

Tack Coat, gas torches and other associated equipment available.

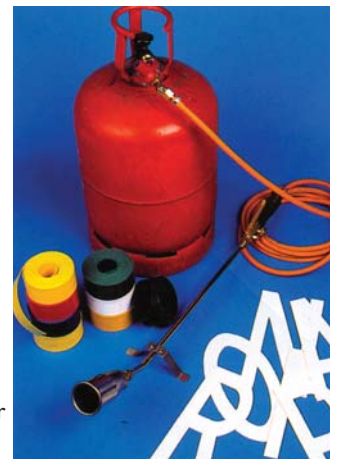

W

ith a highly knowledgeable sales team available to assist with any project at any stage from design through implementation and to completion, and access to a wide range of production facilities, we are committed to providing the complete supply service to our customers.

Based in Berkshire at the heart of the motorway network of the M4, M40 and M25, Street Furnishings Ltd is ideally placed for rapid dispatch of goods from its well stocked warehouse to all parts of the United Kingdom and Ireland - from the Channel Islands to the north of Scotland and from East Anglia to the west of Ireland.

Contact the sales office to speak to people who understand the needs of governmental and local authorities as well as contractors. Or visit the web site for more details of our extensive product range.



Festival House • Mumbery Hill • Wargrave • Berkshire • RG10 8EE
Tel: 01189 404717 • Fax: 01189 403216 • Email: mail@streetfurnishings.co.uk
www.streetfurnishings.co.uk



Member of the Guild of Master Craftsmen