



ELBA PE





## Flaconi cilindrici - Round bottles



Disponibile anche in materiale biodegradabile MOQ 5.000 PZ

Available also in biodegradable material MOQ 5.000 PZ

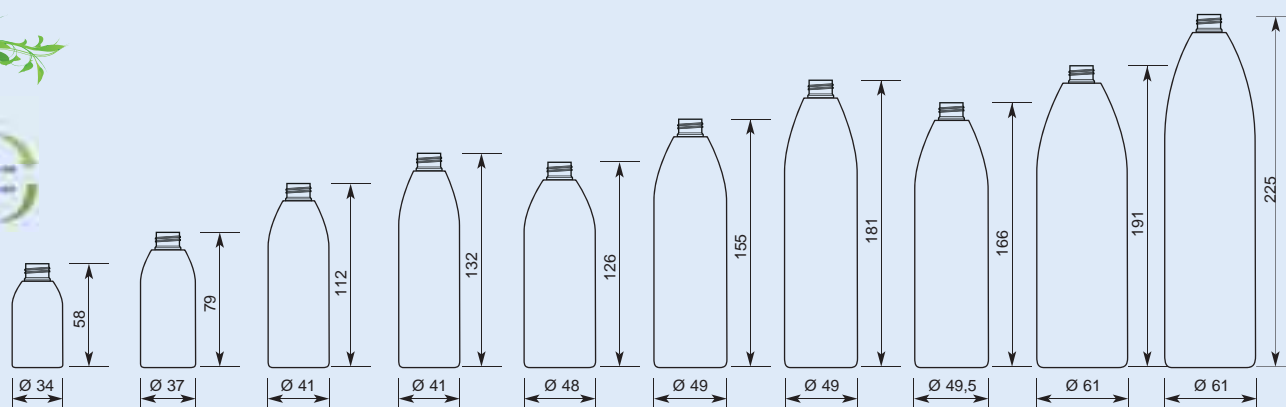

Codice - Code	CL030P	CL050P	CL100P	CL125P	CL150P	CL200P	CL250P	CL300P	CL400P	CL500P
MI	30	50	100	125	150	200	250	300	400	500
Materiale Material	HDPE	HDPE	HDPE	HDPE	HDPE	HDPE	HDPE	HDPE	HDPE	HDPE
GCM	24/410	24/410	24/410	24/410	24/410	24/410	24/410	24/410	24/410	24/410
Colori Standard Standard Colors	bianco e neutro white and natural	bianco e neutro white and natural	bianco e neutro white and natural	bianco e neutro white and natural	bianco e neutro white and natural	bianco e neutro white and natural	bianco e neutro white and natural	bianco e neutro white and natural	bianco e neutro white and natural	bianco e neutro white and natural
Ø	34	37	41	41	48	49	49	49,5	61	61
H	58	79	112	132	126	155	181	166	191	225
Area di stampa Print area	95 x 18	105 x 32	118 x 55	118 x 70	140 x 48	143 x 75	143 x 100	163 x 106	181 x 90	181 x 125
MOQ PZ/PCS	800	500	250	350	350	250	200	120	125	100



**NOTE**

Per il flacone ELBA PE 400-500 ml NON SONO applicabili le seguenti chiusure:  
TA-TV-TU-TL-TLerc

*With ref. to 400-500 ml PE Elba bottle, it isn't possible to use  
TA-TV-TU-TL-TLerc closures*



B = Bianco/White  
A = Arancio/Orange  
F/A = Filo argento/Silver line

N = Nero/Black  
T = Trasparente/Transparent  
F/O = Filo oro/Gold line

U = Neutro/Natural  
D = Anodizzato/Anodized  
M = Metallizzato/Metallized

L = Blu/Blue  
V = Verde/Green

**A RICHIESTA - ON DEMAND**  
Disponibile anche colorati, serigrafati e con stampa a caldo  
Also available coloured, silkscreen printed and hot printed



ELBA PVC



# ELBA PVC



## Flaconi cilindrici - Round bottles



Disponibile anche in materiale biodegradabile  
MOQ 5.000 PZ

Available also in biodegradable material  
MOQ 5.000 PZ

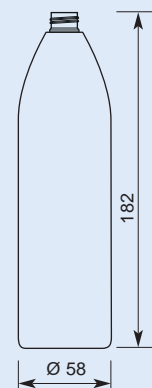
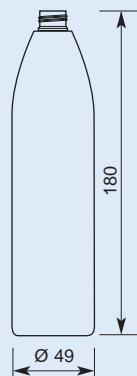
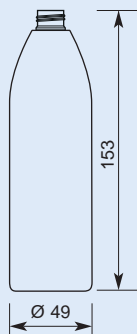
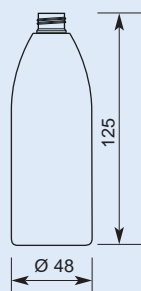

Codice - Code	CL150C	CL200C	CL250C	CL350C
MI	150	200	250	350
Materiale - Material	PVC	PVC	PVC	PVC
GCM	24/410	24/410	24/410	24/410
Colori Standard Standard Colors	neutro satinato - natural frosted	neutro satinato - natural frosted	neutro satinato - natural frosted	neutro satinato - natural frosted
Ø	48	49	49	58
H	125	153	180	182
Area di stampa Print area	140 x 48	143 x 75	143 x 100	172 x 85
MOQ PZ/PCS	350	250	200	150



**NOTE**

With ref. to PVC Elba bottle, it isn't possible to use TAK and TVK closures

B = Bianco/White  
A = Arancio/Orange  
F/A = Filo argento/Silver line

N = Nero/Black  
T = Trasparente/Transparent  
F/O = Filo oro/Gold line

U = Neutro/Natural  
D = Anodizzato/Anodized  
M = Metallizzato/Metallized

L = Blu/Blue  
V = Verde/Green

**A RICHIESTA - ON DEMAND**

Disponibile anche colorati, serigrafati e con stampa a caldo  
Also available coloured, silkscreen printed and hot printed



SM PACK SpA - P.le Vecchia Fornace, 6/A - 43035 Felino - Parma - Italy - EEC  
PLASTIC DIVISION: Tel. +39 0521 334120/34 - Fax +39 0521 804798  
GLASS DIVISION: Tel. +39 0521 836471 - Fax +39 0521 836507  
info@smpack.eu - www.smpack.eu



ELBA BIG PE



# ELBA BIG PE



## Flaconi cilindrici - Round bottles



Disponibile anche in materiale biodegradabile  
MOQ 5.000 PZ

Available also in biodegradable material  
MOQ 5.000 PZ

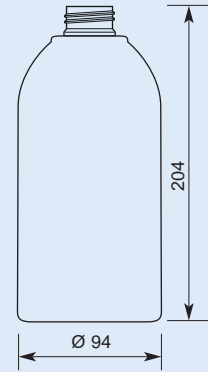
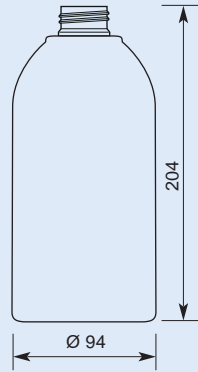
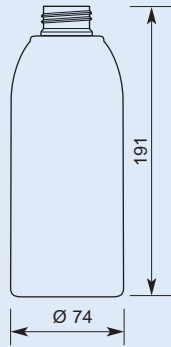

Codice - Code	CL600P	CLA00P	CLA01P
MI	600	1000	1000
Materiale - Material	HDPE	HDPE	HDPE
GCM1	33/410	33/410	SPECIAL
Colori Standard Standard Colors	bianco e neutro - white and natural	bianco e neutro - white and natural	neutro - natural
Ø	74	94	94
H	191	204	204
Area di stampa Print area	222 x 115	285 x 115	285 x 115
MOQ PZ/PCS	150	90	90



Per i flaconi ELBA BIG 600ml e 1000ml (cod CLA00P) SONO APPLICABILI solo le chiusure REFILL - TT, invece per il flacone cod CLA01P solo la chiusura RK

*The bottles Elba big 600 ml and 1000 ml can match only with REFILL - TT closures.  
The bottle CLA01P matches only with RK closure*

B = Bianco/White  
A = Arancio/Orange  
F/A = Filo argento/Silver line

N = Nero/Black  
T = Trasparente/Transparent  
F/O = Filo oro/Gold line

U = Neutro/Natural  
D = Anodizzato/Anodized  
M = Metallizzato/Metallized

L = Blu/Blue  
V = Verde/Green

### A RICHIESTA - ON DEMAND

Disponibile anche colorati, serigrafati e con stampa a caldo  
Also available coloured, silkscreen printed and hot printed



SM PACK SpA - P.le Vecchia Fornace, 6/A - 43035 Felino - Parma - Italy - EEC  
PLASTIC DIVISION: Tel. +39 0521 334120/34 - Fax +39 0521 804798  
GLASS DIVISION: Tel. +39 0521 836471 - Fax +39 0521 836507  
info@smpack.eu - www.smpack.eu



DAFNE PET



# DAFNE PET



## Flaconi cilindrici - Round bottles

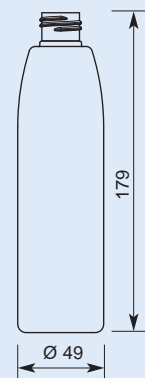
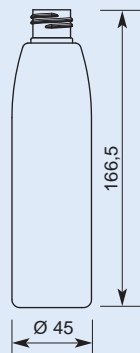
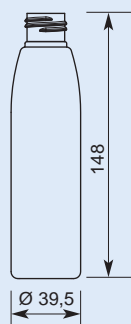

Codice - Code	CM125E	CM200E	CM250E
MI	125	200	250
Materiale - Material	PET	PET	PET
GCM1	24/410	24/410	24/410
Colori Standard Standard Colors	trasparente - crystal	trasparente - crystal	trasparente - crystal
Ø	39,5	45	49
H	148	166,5	179
Area di stampa Print area	83 x 120	96 x 138	105 x 49
MOQ PZ/PCS	330	220	190



B = Bianco/White  
A = Arancio/Orange  
F/A = Filo argento/Silver line

N = Nero/Black  
T = Trasparente/Transparent  
F/O = Filo oro/Gold line

U = Neutro/Natural  
D = Anodizzato/Anodized  
M = Metallizzato/Metallized

L = Blu/Blue  
V = Verde/Green

**A RICHIESTA - ON DEMAND**  
Disponibile anche colorati, serigrafati e con stampa a caldo  
Also available coloured, silkscreen printed and hot printed





HOLLY PET



# HOLLY PET



## Flaconi cilindrici - Round bottles

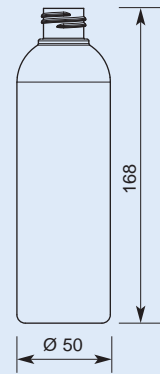
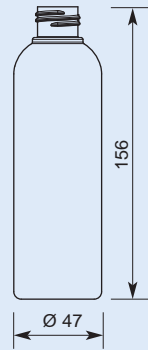
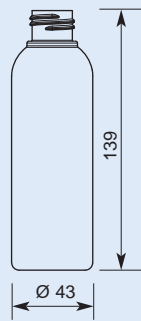

Codice - Code	CG150E	CG200E	CG250E
MI	150	200	250
Materiale - Material	PET	PET	PET
GCM I	24/410	24/410	24/410
Colori Standard Standard Colors	trasparente - crystal	trasparente - crystal	trasparente - crystal
Ø	43	47	50
H	139	156	168
Area di stampa Print area	85 x 133	100 x 143	108 x 153
MOQ PZ/PCS	330	220	190



B = Bianco/White  
A = Arancio/Orange  
F/A = Filo argento/Silver line

N = Nero/Black  
T = Trasparente/Transparent  
F/O = Filo oro/Gold line

U = Neutro/Natural  
D = Anodizzato/Anodized  
M = Metallizzato/Metallized

L = Blu/Blue  
V = Verde/Green

**A RICHIESTA - ON DEMAND**  
Disponibile anche colorati, serigrafati e con stampa a caldo  
Also available coloured, silkscreen printed and hot printed



SM PACK SpA - P.le Vecchia Fornace, 6/A - 43035 Felino - Parma - Italy - EEC  
PLASTIC DIVISION: Tel. +39 0521 334120/34 - Fax +39 0521 804798  
GLASS DIVISION: Tel. +39 0521 836471 - Fax +39 0521 836507  
info@smpack.eu - www.smpack.eu



RYAN PE/PAPIRO 75 PET



# RYAN PE/PAPIRO 75 PET



## Flaconi cilindrici SLIM - SLIM Round bottles

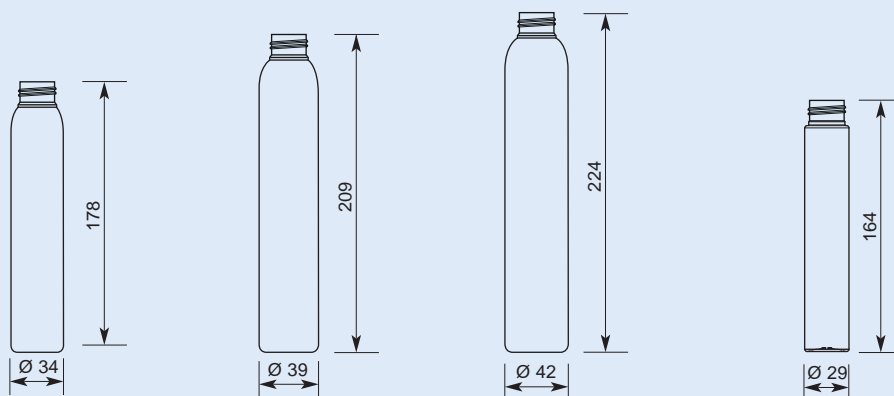

	Ryan			Papiro 75
	DR125C	DR200P	DR250P	CP075E
Codice - Code	DR125C	DR200P	DR250P	CP075E
MI	125	200	250	75
Materiale - Material	HDPE	HDPE	HDPE	PET
GCMi	24/410	24/410	24/410	24/410
Colori Standard Standard Colors	bianco e neutro white and natural	bianco e neutro white and natural	bianco e neutro white and natural	trasparente - crystal
Ø	34	39	42	29
H	178	209	224	164
Area di stampa Print area	96 x 127	112 x 152	121 x 160	123 x 88
MOQ PZ/PCS	264	308	260	350

**24/410**

Abbinabili a RYAN e PAPIRO 75  
Matchable with RYAN and PAPIRO 75

\* Queste chiusure non sono applicabili a RYAN 200/250 ML  
\* These closures aren't matchable with RYAN 200/250 ML

TA B-N-U  
TA+TV o TU      TV B-U-L-A-U+F/A U+F/O      TU U      TL B-N  
TL+TV      TLerc U  
TLerc+TV      TM U-N

Abbinabili solo a RYAN  
Matchable only with RYAN

TMC U      TR U      RE B+F/A  
RE+RS      RV BN  
RV+RS      RZ B+F/A  
RZ+RS      RS U      RL B-U-B+F/O-U+F/A-N

Abbinabili solo a PAPIRO 75  
Matchable only with PAPIRO 75

RN B-U-L-A-N-M-  
B+F/O-U+F/A      RU D      SS B-U      PP B-N-U      TAK M  
TAK+TVK      TVK T

B = Bianco/White  
A = Arancio/Orange  
F/A = Filo argento/Silver line

N = Nero/Black  
T = Trasparente/Transparent  
F/O = Filo oro/Gold line

U = Neutro/Natural  
D = Anodizzato/Anodized  
M = Metallizzato/Metallized

L = Blu/Blue  
V = Verde/Green

**A RICHIESTA - ON DEMAND**  
Disponibile anche colorati, serigrafati e con stampa a caldo  
Also available coloured, silkscreen printed and hot printed



SM PACK SpA - P.le Vecchia Fornace, 6/A - 43035 Felino - Parma - Italy - EEC  
PLASTIC DIVISION: Tel. +39 0521 334120/34 - Fax +39 0521 804798  
GLASS DIVISION: Tel. +39 0521 836471 - Fax +39 0521 836507  
info@sm-pack.eu - www.sm-pack.eu



ZEUS MOUSSE PET



# ZEUS MOUSSE PET



## Flaconi cilindrici - Round bottles

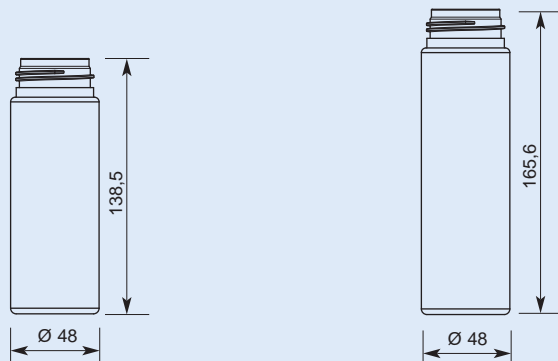

Codice - Code	CN150E	CN200E
MI	150	200
Materiale - Material	PET	PET
GCM1	43	43
Colori Standard Standard Colors	trasparente - crystal	trasparente - crystal
Ø	48	48
H	138,5	165,6
Area di stampa Print area	97 x 146,5	124 x 146,5
MOQ PZ/PCS	240	200

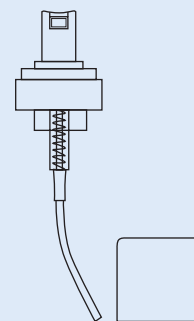

TS 43

Pompa Mousse TF43 + cappuccio trasparente B  
Mousse pompe TF43 + natural cap B

B = Bianco/White  
A = Arancio/Orange  
F/A = Filo argento/Silver line

N = Nero/Black  
T = Trasparente/Transparent  
F/O = Filo oro/Gold line

U = Neutro/Natural  
D = Anodizzato/Anodized  
M = Metallizzato/Metallized

L = Blu/Blue  
V = Verde/Green

**A RICHIESTA - ON DEMAND**

Disponibile anche colorati, serigrafati e con stampa a caldo  
Also available coloured, silkscreen printed and hot printed

**sm**  
PACK

**SM PACK SpA** - P.le Vecchia Fornace, 6/A - 43035 Felino - Parma - Italy - EEC  
PLASTIC DIVISION: Tel. +39 0521 334120/34 - Fax +39 0521 804798  
GLASS DIVISION: Tel. +39 0521 836471 - Fax +39 0521 836507  
info@smpack.eu - www.smpack.eu



LUNA PE



# LUNA PE



## Flaconi cilindrici - Round bottles



Disponibile anche in materiale biodegradabile  
MOQ 5.000 PZ

Available also in biodegradable material  
MOQ 5.000 PZ

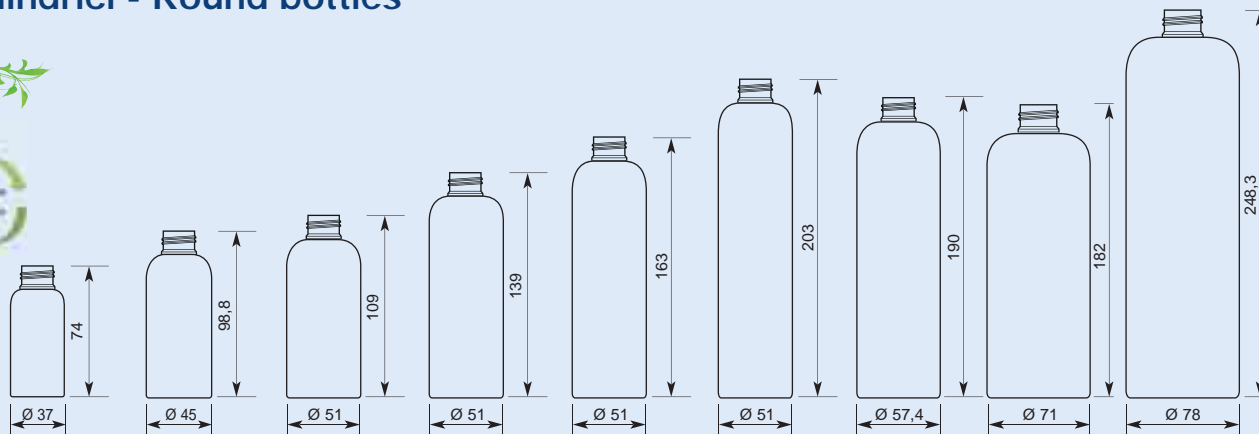

Codice - Code	CH050P	CH125P	CH150P	CH200P	CH250P	CH300P	CH400P	CH500P	CHA00P
MI	50	125	150	200	250	300	400	500	1000
Mat. - Material	HDPE	HDPE	HDPE	HDPE	HDPE	HDPE	HDPE	HDPE	HDPE
GCM1	24/410	24/410	24/410	24/410	24/410	24/410	24/410	28/410	28/410
Colori Standard Standard Colors	bianco e neutro - white and natural								
Ø	37	45	51	51	51	51	57,4	71	78
H	74	98,8	109	139	163	203	190	182	248,3
Area di stampa Print area	105 x 30	136 x 67	150 x 53	150 x 83	150 x 110	150 x 42	174 x 142	212 x 112	240 x 185
MOQ PZ/PCS	500	300	350	250	200	150	80	100	44



### NOTE

Capacità 50/250 ml disponibile in versione Soft Touch. Per il 150 e il 200 ml disponibile solo a richiesta.

Capacity 50/250 ml available also in Soft Touch version. Ref 150 and 200 ml available on demand.

B = Bianco/White  
A = Arancio/Orange  
F/A = Filo argento/Silver line

N = Nero/Black  
T = Trasparente/Transparent  
F/O = Filo oro/Gold line

U = Neutro/Natural  
D = Anodizzato/Anodized  
M = Metallizzato/Metallized

L = Blu/Blue  
V = Verde/Green

### A RICHIESTA - ON DEMAND

Disponibile anche colorati, serigrafati e con stampa a caldo  
Also available coloured, silkscreen printed and hot printed



SM PACK SpA - P.le Vecchia Fornace, 6/A - 43035 Felino - Parma - Italy - EEC  
PLASTIC DIVISION: Tel. +39 0521 334120/34 - Fax +39 0521 804798  
GLASS DIVISION: Tel. +39 0521 836471 - Fax +39 0521 836507  
info@smpack.eu - www.smpack.eu





LUNA PVC



# LUNA PVC



## Flaconi cilindrici - Round bottles



Disponibile anche in materiale biodegradabile  
MOQ 5.000 PZ

Available also in biodegradable material  
MOQ 5.000 PZ

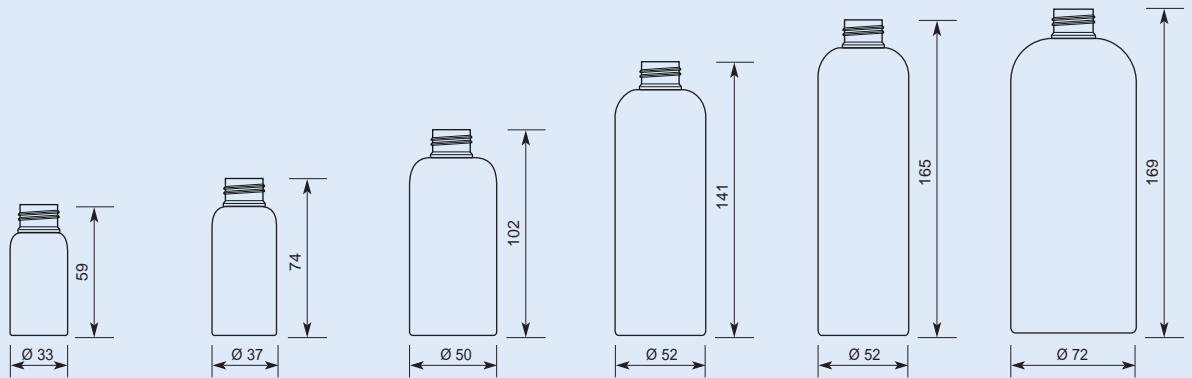

Codice - Code	CH030C	CH050C	CH125C	CH200C	CH250C	CH500C
MI	30	50	125	200	250	500
Materiale - Material	PVC	PVC	PVC	PVC	PVC	PVC
GCM	24/410	24/410	24/410	24/410	24/410	28/410
Colori Standard Standard Colors	bianco e neutro white and natural	bianco e neutro white and natural	bianco e neutro white and natural	bianco e neutro white and natural	bianco e neutro white and natural	bianco e neutro white and natural
Ø	33	37	50	52	52	72
H	59	74	102	141	165	169
Area di stampa Print area	93 x 23	105 x 30	147 x 45	153 x 73	153 x 105	215 x 97
MOQ PZ/PCS	800	500	200	250	200	100



B = Bianco/White  
A = Arancio/Orange  
F/A = Filo argento/Silver line

N = Nero/Black  
T = Trasparente/Transparent  
F/O = Filo oro/Gold line

U = Neutro/Natural  
D = Anodizzato/Anodized  
M = Metallizzato/Metallized

L = Blu/Blue  
V = Verde/Green

**A RICHIESTA - ON DEMAND**  
Disponibile anche colorati, serigrafati e con stampa a caldo  
Also available coloured, silkscreen printed and hot printed



SM PACK SpA - P.le Vecchia Fornace, 6/A - 43035 Felino - Parma - Italy - EEC  
PLASTIC DIVISION: Tel. +39 0521 334120/34 - Fax +39 0521 804798  
GLASS DIVISION: Tel. +39 0521 836471 - Fax +39 0521 836507  
info@sm-pack.eu - www.sm-pack.eu



GIULIA PE



# GIULIA PE



## Flaconi ellittici - Elliptical bottles



Disponibile anche in materiale biodegradabile  
MOQ 5.000 PZ

Available also in biodegradable material  
MOQ 5.000 PZ

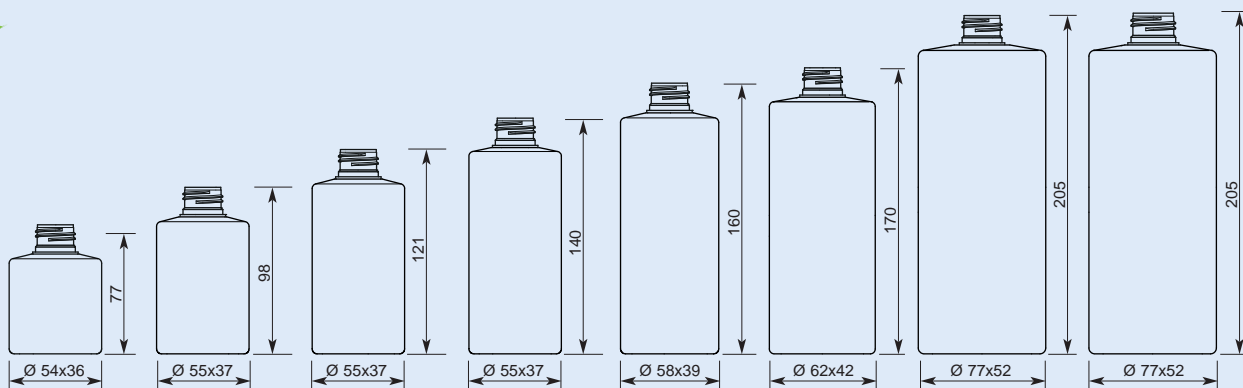

Codice - Code	ED075P	ED100P	ED125P	ED150P	ED200P	ED250P	ED500P	ED501P
MI	75	100	125	150	200	250	500	500
Materiale - Material	HDPE	HDPE	HDPE	HDPE	HDPE	HDPE	HDPE	HDPE
GCM1	24/410	24/410	24/410	24/410	24/410	24/410	24/410	28/410
Colori Standard Standard Colors	bianco e neutro white and natural	bianco e neutro white and natural	bianco e neutro white and natural	bianco e neutro white and natural	bianco e neutro white and natural	bianco e neutro white and natural	bianco e neutro white and natural	bianco e neutro white and natural
Ø	54 x 36	55 x 37	55 x 37	55 x 37	58 x 39	62 x 42	77 x 52	77 x 52
H	77	98	121	140	160	170	205	205
Area di stampa Print area	40 x 35 x 2	40 x 60 x 2	40 x 80 x 2	40 x 96 x 2	44 x 116 x 2	47 x 130 x 2	50 x 155 x 2	50 x 155 x 2
MOQ PZ/PCS	350	270	200	350	250	220	100	100



B = Bianco/White  
A = Arancio/Orange  
F/A = Filo argento/Silver line

N = Nero/Black  
T = Trasparente/Transparent  
F/O = Filo oro/Gold line

U = Neutro/Natural  
D = Anodizzato/Anodized  
M = Metallizzato/Metallized

L = Blu/Blue  
V = Verde/Green

**A RICHIESTA - ON DEMAND**  
Disponibile anche colorati, serigrafati e con stampa a caldo  
Also available coloured, silkscreen printed and hot printed



SM PACK SpA - P.le Vecchia Fornace, 6/A - 43035 Felino - Parma - Italy - EEC  
PLASTIC DIVISION: Tel. +39 0521 334120/34 - Fax +39 0521 804798  
GLASS DIVISION: Tel. +39 0521 836471 - Fax +39 0521 836507  
info@sm-pack.eu - www.sm-pack.eu



APOLLO PE



# APOLLO PE



## Flaconi cilindrici - Round bottles



Disponibile anche in materiale biodegradabile  
MOQ 5.000 PZ

Available also in biodegradable material  
MOQ 5.000 PZ

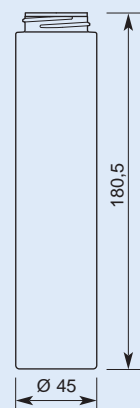
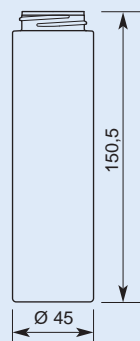
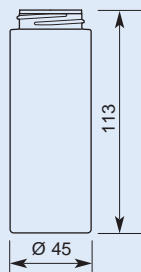

Codice - Code	CZ150	CZ200	CZ250
MI	150	200	250
Materiale - Material	HDPE	HDPE	HDPE
GCM1	M38/400	M38/400	M38/400
Colori Standard Standard Colors	bianco e neutro - white and natural	bianco e neutro - white and natural	bianco e neutro - white and natural
Ø	45	45	45
H	113	150,5	180,5
Area di stampa Print area	136 x 93	136 x 130	136 x 161
MOQ PZ/PCS	230	180	130

M38/400



RP  
B-U

NOTE

A RICHIESTA: capacità 150/200 disponibile in versione Soft Touch  
*ON DEMAND: capacity 150/200 available also in Soft Touch version*

B = Bianco/White  
A = Arancio/Orange  
F/A = Filo argento/Silver line

N = Nero/Black  
T = Trasparente/Transparent  
F/O = Filo oro/Gold line

U = Neutro/Natural  
D = Anodizzato/Anodized  
M = Metallizzato/Metallized

L = Blu/Blue  
V = Verde/Green

**A RICHIESTA - ON DEMAND**

Disponibile anche colorati, serigrafati e con stampa a caldo  
*Also available coloured, silkscreen printed and hot printed*



PARMA PE



# PARMA PE



## Flaconi cilindrici - Round bottles



Disponibile anche in materiale biodegradabile  
MOQ 5.000 PZ

Available also in biodegradable material  
MOQ 5.000 PZ

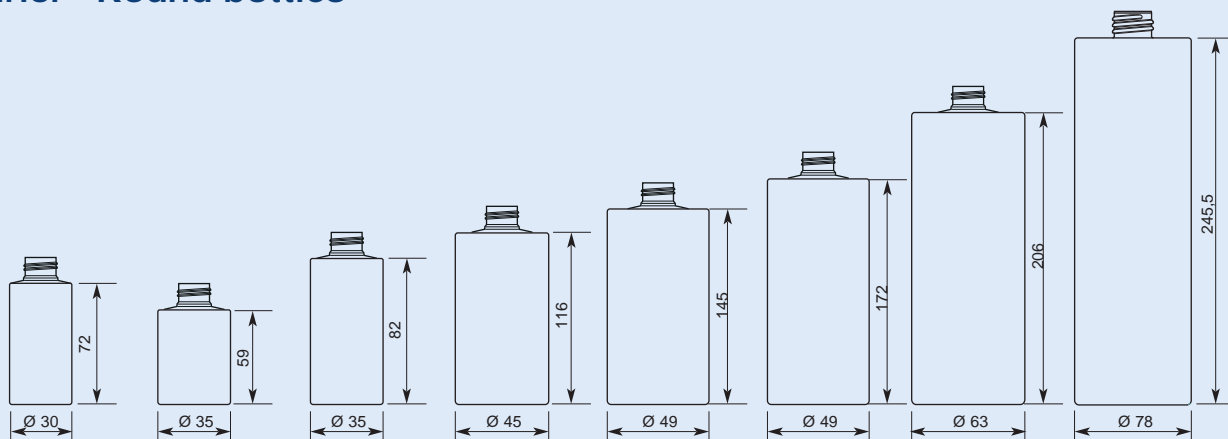

Codice - Code	CD025P	CD030P	CD050P	CD125P	CD200P	CD250P	CD500P	CDA00P
MI	25	30	50	125	200	250	500	1000
Materiale - Material	LDPE	HDPE	HDPE	HDPE	HDPE	HDPE	HDPE	PE
GCM	24/410	24/410	24/410	24/410	24/410	24/410	24/410	28/410
Colori Standard Standard Colors	bianco e neutro white and natural	bianco e neutro white and natural	bianco e neutro white and natural	bianco e neutro white and natural	bianco e neutro white and natural	bianco e neutro white and natural	bianco e neutro white and natural	bianco e neutro white and natural
Ø	30	35	35	45	49	49	63	78
H	72	59	82	116	145	172	206	245,5
Area di stampa Print area	85 x 40	100 x 25	100 x 50	131 x 78	143 x 105	143 x 130	187 x 150	239 x 220
MOQ PZ/PCS	800	800	500	200	250	200	100	45



B = Bianco/White  
A = Arancio/Orange  
F/A = Filo argento/Silver line

N = Nero/Black  
T = Trasparente/Transparent  
F/O = Filo oro/Gold line

U = Neutro/Natural  
D = Anodizzato/Anodized  
M = Metallizzato/Metallized

L = Blu/Blue  
V = Verde/Green

**A RICHIESTA - ON DEMAND**  
Disponibile anche colorati, serigrafati e con stampa a caldo  
Also available coloured, silkscreen printed and hot printed



SM PACK SpA - P.le Vecchia Fornace, 6/A - 43035 Felino - Parma - Italy - EEC  
PLASTIC DIVISION: Tel. +39 0521 334120/34 - Fax +39 0521 804798  
GLASS DIVISION: Tel. +39 0521 836471 - Fax +39 0521 836507  
info@sm-pack.eu - www.sm-pack.eu





GEL PVC/NO GAS PET ■■■

# GEL PVC/NO GAS PET



## Flaconi cilindrici - SLIM Round bottles



Disponibile anche in materiale biodegradabile  
MOQ 5.000 PZ

Available also in biodegradable material  
MOQ 5.000 PZ

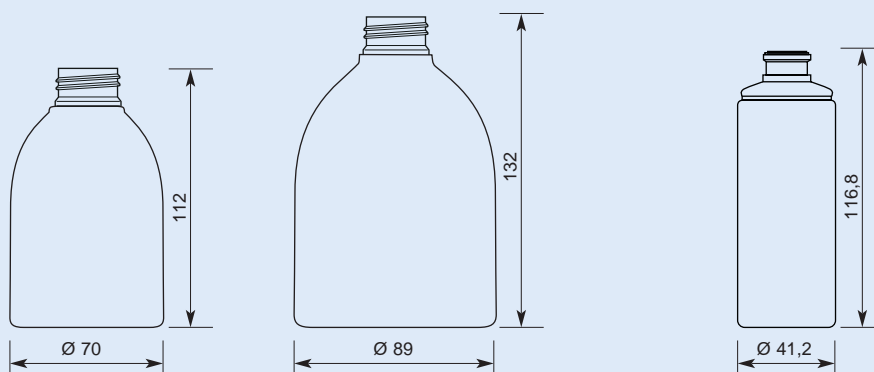

Codice - Code
MI
Materiale - Material
GCM
Colori Standard Standard Colors
Ø
H
Area di stampa Print area
MOQ PZ/PCS

GEL PVC		NO GAS
CQ250C	CQ500C	CU100E
250	500	100
PVC	PVC	PET
28/410	28/410	DIN 20
trasparente - crystal	trasparente - crystal	trasparente - crystal
70	89	41,2
112	132	116,8
NO PRINT	NO PRINT	131,88 x 82
200	100	252

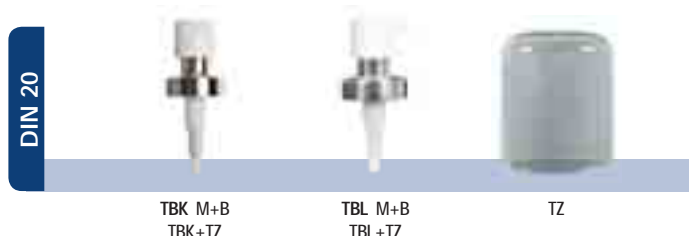

B = Bianco/White  
A = Arancio/Orange  
F/A = Filo argento/Silver line

N = Nero/Black  
T = Trasparente/Transparent  
F/O = Filo oro/Gold line

U = Neutro/Natural  
D = Anodizzato/Anodized  
M = Metallizzato/Metallized

L = Blu/Blue  
V = Verde/Green

**A RICHIESTA - ON DEMAND**  
Disponibile anche colorati, serigrafati e con stampa a caldo  
Also available coloured, silkscreen printed and hot printed



SM PACK SpA - P.le Vecchia Fornace, 6/A - 43035 Felino - Parma - Italy - EEC  
PLASTIC DIVISION: Tel. +39 0521 334120/34 - Fax +39 0521 804798  
GLASS DIVISION: Tel. +39 0521 836471 - Fax +39 0521 836507  
info@smpack.eu - www.smpack.eu



MILOS PP



# MILOS PP



## Vasetti cilindrici monoparete - Single wall round jars

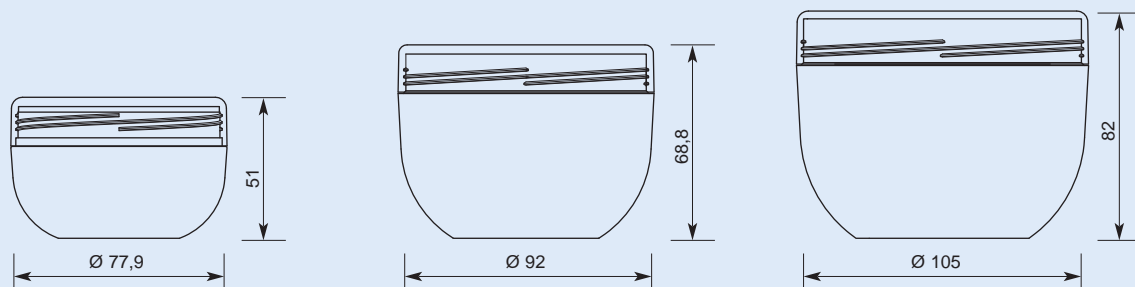

Codice - Code	HJ150R	HJ300R	HJ500R
MI	150	300	500
Materiale - Material	PP	PP	PP
GCM1	vite - screw	vite - screw	vite - screw
Colori Standard Standard Colors	bianco e neutro - white and natural	bianco e neutro - white and natural	bianco e neutro - white and natural
Ø	77,9	92	105
H	51	68,8	82
Area di stampa corpo Body print area	10 x 235	18 x 275	22,8 x 320
Area di stampa coperchio Lid printing area	Ø 63	Ø 78	Ø 86,5
MOQ PZ/PCS	380	225	126

**150 PP**  
fondo + piattina + coperchio  
body + undercap + cap

**300 PP**  
fondo + piattina + coperchio  
body + undercap + cap

**500 PP**  
fondo + piattina + coperchio/LK + TH o THC  
body + undercap + cap/ LK + TH or THC

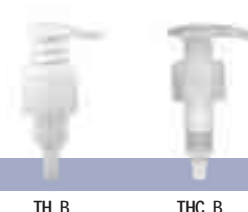

B = Bianco/White  
A = Arancio/Orange  
F/A = Filo argento/Silver line

N = Nero/Black  
T = Trasparente/Transparent  
F/O = Filo oro/Gold line

U = Neutro/Natural  
D = Anodizzato/Anodized  
M = Metallizzato/Metallized

L = Blu/Blue  
V = Verde/Green

**A RICHIESTA - ON DEMAND**  
Disponibili anche colorati, serigrafati e con guarnizione  
polespan montata - Also available coloured, silkscreen  
printed and with polespan cap



KOS PP





## Vasetti cilindrici monoparete - Single wall round jars

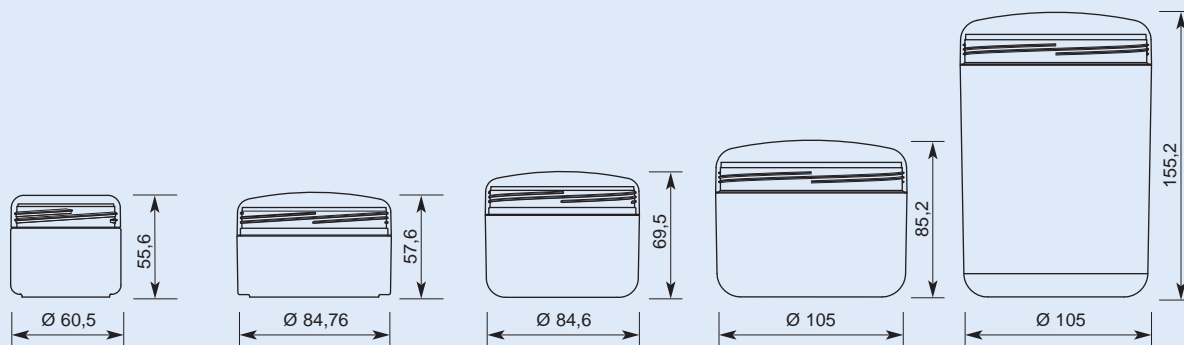

Codice - Code	HK100R	HK200R	HK250R	HK500R	HKA00R
MI	100	200	250	500	1000
Materiale - Material	PP	PP	PP	PP	PP
GCM1	vite - screw	vite - screw	vite - screw	vite - screw	vite - screw
Colori Standard Standard Colors	bianco e neutro white and natural	bianco e neutro white and natural	bianco e neutro white and natural	bianco e neutro white and natural	bianco e neutro white and natural
Ø	60,5	84,76	84,6	105	105
H	55,6	57,6	69,5	85,2	155,2
Area di stampa corpo Body print area	22 x 184	22,5 x 257	27,7 x 256	36 x 320	102 x 314
Area di stampa coperchio Lid printing area	no	no	no	no	no
MOQ PZ/PCS	500	270	224	126	42

**100 PP**  
fondo + coperchio con polespan  
body + cap with polespan liner

**200 PP  
250 PP**  
fondo + piattina + coperchio  
body + undercap + cap

**500 PP  
1000 PP**  
fondo + piattina + coperchio/LK + TH o THC  
body + undercap + cap/ LK + TH or THC

TH B      THC B

B = Bianco/White  
A = Arancio/Orange  
F/A = Filo argento/Silver line

N = Nero/Black  
T = Trasparente/Transparent  
F/O = Filo oro/Gold line

U = Neutro/Natural  
D = Anodizzato/Anodized  
M = Metallizzato/Metallized

L = Blu/Blue  
V = Verde/Green

**A RICHIESTA - ON DEMAND**  
Disponibili anche colorati, serigrafati e con guarnizione polespan montata - Also available coloured, silkscreen printed and with polespan cap



NAXOS PP



# NAXOS PP



## Vasetti cilindrici a doppia parete - Double wall round jars



Disponibile anche in materiale biodegradabile  
MOQ 5.000 PZ

Available also in biodegradable material  
MOQ 5.000 PZ

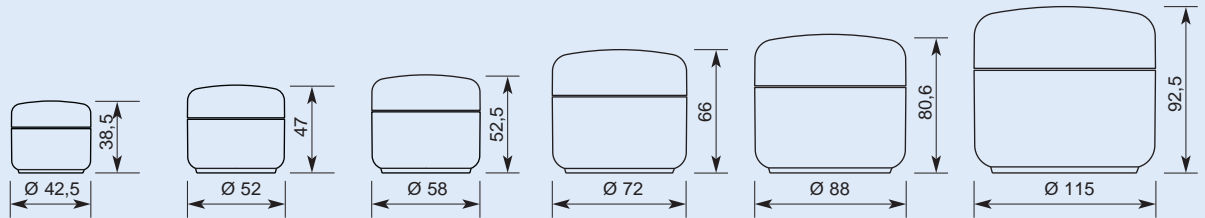

Codice - Code	GN015R	GN030R	GN050R	GN100R	GN250R	GN500R
MI	15	30	50	100	250	500
Materiale - Material	PP	PP	PP	PP	PP	PP
GCM1	vite - screw	vite - screw	vite - screw	vite - screw	vite - screw	vite - screw
Colori Standard Standard Colors	bianco e neutro satinato* white and natural frosted*	bianco e neutro satinato* white and natural frosted*	bianco e neutro satinato* white and natural frosted*	bianco e neutro satinato* white and natural frosted*	bianco e neutro satinato* white and natural frosted*	bianco e neutro satinato* white and natural frosted*
Ø	42,5	52	58	72	88	115
H	38,5	47	52,5	66	80,6	92,5
Area di stampa corpo Body print area	128 x 12	158 x 15	178 x 18	221 x 24	271 x 31	355 x 33
Area di stampa coperchio Lid printing area	no	no	no	no	no	no
MOQ PZ/PCS	800	400	300	156	96	60

### chiusure

fondo + pattina + coperchio  
body + undercap + cap

### NOTE

Disponibile a richiesta anche la versione 200 ml. Dimensioni esterne uguali al 250 ml. / 200 ml size available. External dimension as per 250 ml.

\* Versioni standard aggiuntive previste: bianco + coperchio con filo oro e satinato + coperchio con filo argento.  
\* Additional standard version: white + gold line on the cap and natural frosted + silver line on the cap.

B = Bianco/White  
A = Arancio/Orange  
F/A = Filo argento/Silver line

N = Nero/Black  
T = Trasparente/Transparent  
F/O = Filo oro/Gold line

U = Neutro/Natural  
D = Anodizzato/Anodized  
M = Metallizzato/Metallized

L = Blu/Blue  
V = Verde/Green

**A RICHIESTA - ON DEMAND**  
Disponibili anche colorati, serigrafati e con guarnizione polespan montata - Also available coloured, silkscreen printed and with polespan cap



SM PACK SpA - P.le Vecchia Fornace, 6/A - 43035 Felino - Parma - Italy - EEC  
PLASTIC DIVISION: Tel. +39 0521 334120/34 - Fax +39 0521 804798  
GLASS DIVISION: Tel. +39 0521 836471 - Fax +39 0521 836507  
info@smpack.eu - www.smpack.eu





KRETA PP



# KRETA PP



## Vasetti cilindrici a doppia parete - Double wall round jars



Disponibile anche in materiale biodegradabile  
MOQ 5.000 PZ

Available also in biodegradable material  
MOQ 5.000 PZ

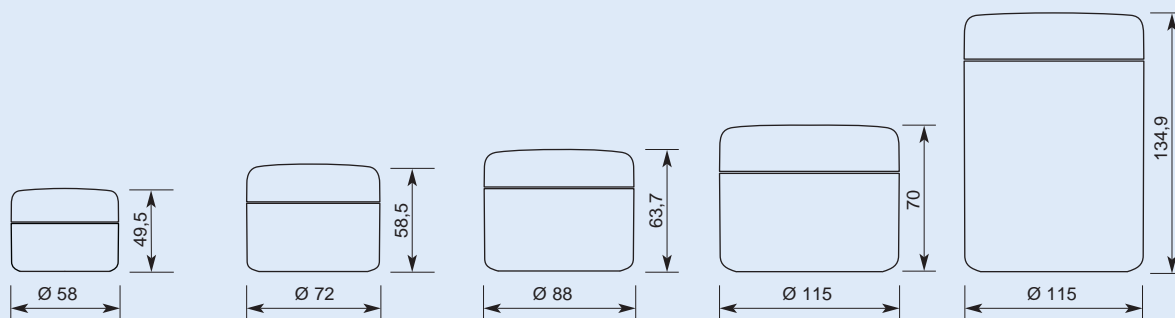

Codice - Code	GM050R	GM100R	GM250R	GM500R	GMA00R
MI	50	100	250	500	1000
Materiale - Material	PP	PP	PP	PP	PP
GCM	vite - screw	vite - screw	vite - screw	vite - screw	vite - screw
Colori Standard Standard Colors	bianco e neutro white and natural	bianco e neutro white and natural	bianco e neutro white and natural	bianco e neutro white and natural	bianco e neutro white and natural
Ø	58	72	88	115	115
H	49,5	58,5	63,7	70	134,9
Area di stampa corpo Body print area	177 x 23	221 x 26	271 x 30	355 x 33	355 x 90
Area di stampa coperchio Lid printing area	Ø 46	Ø 60	Ø 76	Ø 97	Ø 97
MOQ PZ/PCS	300	156	96	75	45

**050 PP**  
**100 PP**  
**250 PP**

fondo + piattina + coperchio  
body + undercap + cap

**500 PP**  
**1000 PP**

fondo + piattina + coperchio/LK + TH o THC  
body + undercap + cap/ LK + TH or THC

TH B      THC B

B = Bianco/White  
A = Arancio/Orange  
F/A = Filo argento/Silver line

N = Nero/Black  
T = Trasparente/Transparent  
F/O = Filo oro/Gold line

U = Neutro/Natural  
D = Anodizzato/Anodized  
M = Metallizzato/Metallized

L = Blu/Blue  
V = Verde/Green

**A RICHIESTA - ON DEMAND**  
Disponibili anche colorati, serigrafati e con guarnizione polespan montata - Also available coloured, silkscreen printed and with polespan cap



**SM PACK SpA** - P.le Vecchia Fornace, 6/A - 43035 Felino - Parma - Italy - EEC  
PLASTIC DIVISION: Tel. +39 0521 334120/34 - Fax +39 0521 804798  
GLASS DIVISION: Tel. +39 0521 836471 - Fax +39 0521 836507  
info@smpack.eu - www.smpack.eu



RODI PP





## Vasetti cilindrici a doppia parete - Double wall round jars

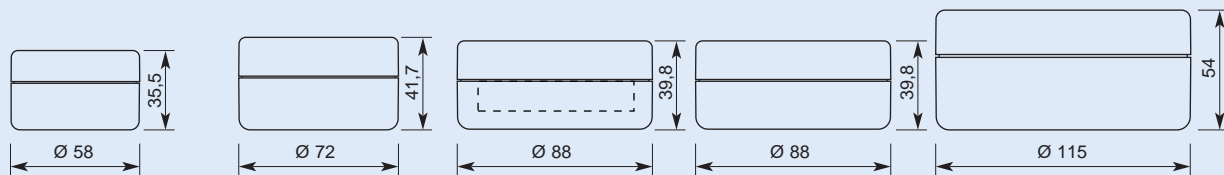

Codice - Code	GR050R	GR100R	GR105R	GR150R	GR250R
MI	50	100	100B	150	250
Materiale - Material	PP	PP	PP	PP	PP
GCM1	vite - screw	vite - screw	vite - screw	vite - screw	vite - screw
Colori Standard Standard Colors	bianco e neutro white and natural	bianco e neutro white and natural	satinato natural frosted	bianco e neutro white and natural	bianco e neutro white and natural
Ø	58	72	88	88	115
H	35,5	41,7	39,8	39,8	54
Area di stampa corpo Body print area	177 x 9	221 x 11	271 x 10	271 x 10	356 x 20
Area di stampa coperchio Lid printing area	Ø 46	Ø 60	Ø 76	Ø 76	Ø 97
MOQ PZ/PCS	360	234	168	168	75

### chiusure

fondo + piattina + coperchio  
body + undercap + cap

B = Bianco/White  
A = Arancio/Orange  
F/A = Filo argento/Silver line

N = Nero/Black  
T = Trasparente/Transparent  
F/O = Filo oro/Gold line

U = Neutro/Natural  
D = Anodizzato/Anodized  
M = Metallizzato/Metallized

L = Blu/Blue  
V = Verde/Green

**A RICHIESTA - ON DEMAND**  
Disponibili anche colorati, serigrafati e con guarnizione  
polespan montata - Also available coloured, silkscreen  
printed and with polespan cap



POT-S SAN



# POT-S SAN



## Vasetti cilindrici a doppia parete - Double wall round jars

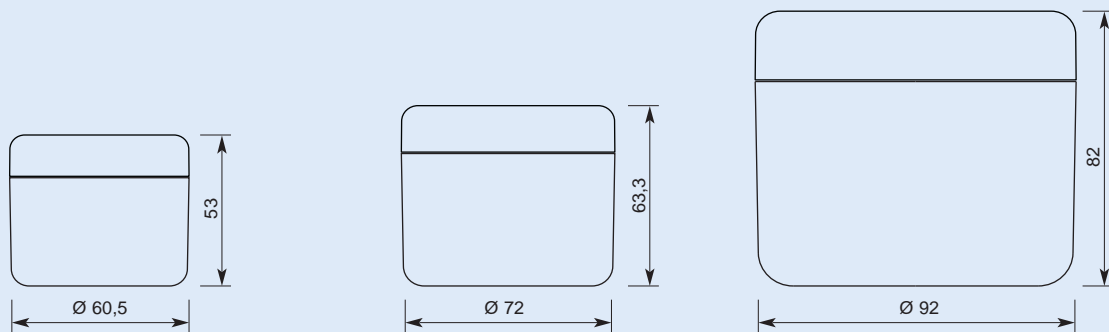

Codice - Code	GB050S	GB100S	GB250S
MI	50	100	250
Materiale - Material	SAN	SAN	SAN
GCM1	vite - screw	vite - screw	vite - screw
Colori Standard Standard Colors	bianco, satinato e cristallo white, frosted and crystal	bianco, satinato e cristallo white, frosted and crystal	bianco, satinato e cristallo white, frosted and crystal
Ø	60,5	72	92
H	53	63,3	82
Area di stampa corpo Body print area	184 x 25	221 x 30	283 x 41
Area di stampa coperchio Lid printing area	Ø 44	Ø 50	Ø 70
MOQ PZ/PCS	270	156	72

chiusure

fondo + piattina + coperchio  
body + undercap + cap

B = Bianco/White  
A = Arancio/Orange  
F/A = Filo argento/Silver line

N = Nero/Black  
T = Trasparente/Transparent  
F/O = Filo oro/Gold line

U = Neutro/Natural  
D = Anodizzato/Anodized  
M = Metallizzato/Metallized

L = Blu/Blue  
V = Verde/Green

LINEA DISPONIBILE SOLO A RICHIESTA  
ALL ITEMS ARE AVAILABLE ONLY ON DEMAND

sm  
PACK

SM PACK SpA - P.le Vecchia Fornace, 6/A - 43035 Felino - Parma - Italy - EEC  
PLASTIC DIVISION: Tel. +39 0521 334120/34 - Fax +39 0521 804798  
GLASS DIVISION: Tel. +39 0521 836471 - Fax +39 0521 836507  
info@smpack.eu - www.smpack.eu



ARAMIS PP



# ARAMIS PP



## Vasetti cilindrici monoparete - Single wall round jars



Disponibile anche in  
materiale biodegradabile  
MOQ 5.000 PZ

Available also in  
biodegradable material  
MOQ 5.000 PZ

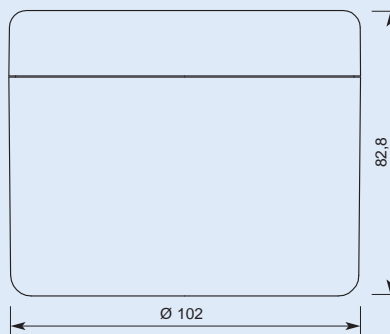
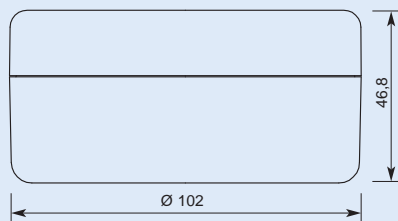

Codice - Code	GA250	GA500
MI	250	500
Materiale - Material	PP	PP
GCM	vite - screw	vite - screw
Colori Standard Standard Colors	bianco e trasparente white and crystal	bianco e trasparente white and crystal
Ø	102	102
H	46,8	82,8
Area di stampa corpo Body print area	312 x 9	312 x 45
Area di stampa coperchio Lid printing area	Ø 75	Ø 75
MOQ PZ/PCS	120	80

chiusure

fondo + piattina + coperchio  
body + undercap + cap

B = Bianco/White  
A = Arancio/Orange  
F/A = Filo argento/Silver line

N = Nero/Black  
T = Trasparente/Transparent  
F/O = Filo oro/Gold line

U = Neutro/Natural  
D = Anodizzato/Anodized  
M = Metallizzato/Metallized

L = Blu/Blue  
V = Verde/Green

**A RICHIESTA - ON DEMAND**  
Disponibili anche colorati, serigrafati e con guarnizione  
polespan montata - Also available coloured, silkscreen  
printed and with polespan cap

**sm**  
PACK

**SM PACK SpA** - P.le Vecchia Fornace, 6/A - 43035 Felino - Parma - Italy - EEC  
PLASTIC DIVISION: Tel. +39 0521 334120/34 - Fax +39 0521 804798  
GLASS DIVISION: Tel. +39 0521 836471 - Fax +39 0521 836507  
info@smpack.eu - www.smpack.eu





CHIUSURE



# CHIUSURE



	<b>24/410</b> Tappo a vite RE B+F/A 24 / 410		Tappo Flip-Top RN B-U-L-A-N-M B+F/O-U+F/A 24 / 410		Nebulizzatore MCL 60 TAK M 24 / 410		Dispenser CC 1 THC B 28 / 410
	Tappo a vite RV B-N 24 / 410		Dosatore SS B-U 24 / 410		Minitrigger ML 0,25 TR U 24 / 410		<b>33/410</b> Dispenser C/ Dosaggi – CC 3,5/5/7,5 TT U 33 / 410
	Tappo a vite RZ B+F/A 24 / 410		Nebulizzatore MCL 130 TA B-N-U 24 / 410		Dispenser CC 1,5 TM U-N 24 / 410		Tappo a vite REFILL B-U 33 / 410
	Tappo a vite RU D 24 / 410		Dispenser Liposomi MCL 190 TL B-N 24 / 410		Dispenser CC 1 TMC U 24 / 410		<b>SPECIAL</b> Tappo a leva RK B SPECIAL
	Riduttore forato RS U 24 / 410		Dispenser Liposomi MCL 190 TLerc U 24 / 410		<b>28/410</b> Tappo a vite RT D 28 / 410		<b>AG 20</b> Nebulizzatore MCL 130 TBK M+B DIN 20
	Riduttore forato RSpet U 24 / 410		Copri pompa TV B-U-L-A U+F/A U+F/O 24 / 410		Tappo Flip-Top RH B-U-L-V 28 / 410		Dispenser Liposomi MCL 190 TBL M+B DIN 20
	Push Pull PP B-N-U 24 / 410		Salva tasto TU U 24 / 410		Tappo Flip-Top RM B-U 28 / 410		Copri zpompa TZ T
	Tappo Disc-top RL B-U-B+F/O- U+F/A-N 24 / 410		Copri pompa TVK T 24 / 410		Dispenser CC 2,5 TH B 28 / 410		<b>M38 / 400</b> Tappo Flip-Top RP B-U 38 / 400

B = Bianco/White  
A = Arancio/Orange  
F/A = Filo argento/Silver line

N = Nero/Black  
T = Trasparente/Transparent  
F/O = Filo oro/Gold line

U = Neutro/Natural  
D = Anodizzato/Anodized  
M = Metallizzato/Metallized

L = Blu/Blue  
V = Verde/Green



# FIALE COSMETICHE



# FIALE COSMETICHE



## Punta aperta oliva

	13,75		14,75				16,75							
	5ml.	1,00	5ml.	6ml.	7ml.	8ml.	10ml.	12ml.	1,00	1,00	1,00			
H1	101,00	1,00	106,00	1,00	110,00	1,00	123,00	1,00	110,00	1,00	115,00	1,00	124,00	1,00
H2	80,00	1,00	82,00	1,00	89,00	1,00	100,00	1,00	86,00	1,00	90,00	1,00	103,00	1,00
H3/1	48,00	1,00	46,00	1,00	52,00	1,00	66,00	1,00	56,00	1,00	60,00	1,00	68,00	1,00
H3/2	57,00	1,00	56,00	1,00	64,50	1,00	78,00	1,00	68,00	1,00	71,00	1,00	80,00	1,00
H4	45,00	0,50	41,50	0,50	48,00	0,50	62,00	0,50	45,00	0,50	55,00	0,50	63,00	0,50
D1	13,75	0,13	14,75	0,13	14,75	0,13	14,75	0,13	16,75	0,13	16,75	0,13	16,75	0,13
D2	6,00	0,40	6,40	0,40	6,40	0,40	6,40	0,40	6,40	0,40	6,40	0,40	6,40	0,40
D3/1	9,00	0,50	9,00	0,50	9,00	0,50	9,00	0,50	9,50	0,50	9,50	0,50	9,50	0,50
D3/2	7,00	0,50	7,00	0,50	7,00	0,50	7,00	0,50	7,00	0,50	7,00	0,50	7,00	0,50
D4	10,00	0,50	10,00	0,50	10,00	0,50	10,00	0,50	10,00	0,50	10,00	0,50	10,00	0,50
D5	11,00	1,00	11,00	0,50	11,00	1,00	11,00	1,00	12,00	1,00	12,00	1,00	12,00	1,00
S1	0,55	0,03	0,55	0,03	0,55	0,03	0,55	0,03	0,60	0,03	0,60	0,03	0,60	0,03
S2	0,37	0,05	0,37	0,05	0,37	0,05	0,37	0,05	0,38	0,05	0,38	0,05	0,38	0,05
S3	0,55	0,10	0,55	0,10	0,55	0,10	0,55	0,10	0,60	0,10	0,60	0,10	0,60	0,10

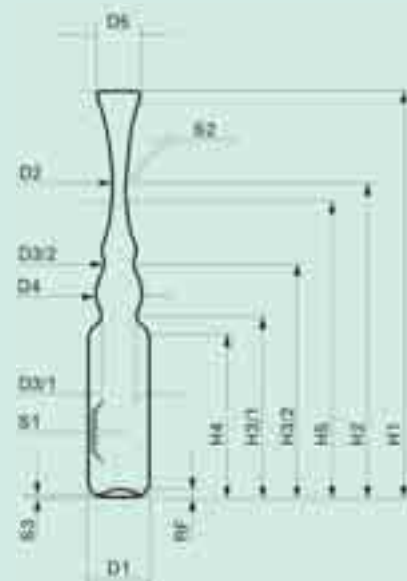

### ACCESSORI - fitments:

- Tettarella con o senza cappuccio in PVC - PE - COPOLIMERO ETILENE / PVC - PE - COPOLYMER ETHYLENE dropper with or without cap
- Rompipiale mono e pluriuso in PE / PE single or multi use ampoules breaking device

## Punta aperta

	10,75		12,75	14,75	17,75	22,50								
	1ml.	2ml.	3ml.	5ml.	10ml.	20ml.	12ml.							
H1	67,00	1,00	79,00	1,00	82,00	1,00	90,00	1,00	109,00	1,00	120,00	1,00	124,00	1,00
H2	47,00	1,00	57,00	1,00	62,00	1,00	68,00	1,00	87,00	1,00	100,00	1,00	103,00	1,00
H3	25,50	1,00	37,50	1,00	39,50	1,00	46,50	1,00	62,00	1,00	76,00	1,00	68,00	1,00
H4	21,00	0,50	23,00	0,50	36,00	0,50	43,00	0,50	58,00	0,50	71,00	0,50	80,00	1,00
D1	10,75	0,13	10,75	0,13	12,75	0,13	14,75	0,13	17,75	0,15	22,50	0,20	63,00	0,50
D2	6,00	0,40	6,00	0,40	6,00	0,40	7,00	0,40	7,50	0,40	7,80	0,40	16,75	0,13
D3	6,50	0,50	6,50	0,50	6,50	0,50	7,50	0,50	7,50	0,50	9,00	0,50	6,40	0,40
D4	10,00	0,50	10,00	0,50	10,00	0,50	10,00	0,50	10,00	0,50	10,00	0,50	9,50	0,50
D5	10,00	1,00	10,00	0,50	11,00	1,00	13,00	1,00	13,00	1,00	14,00	1,00	7,00	0,50
S1	0,50	0,03	0,50	0,03	0,50	0,03	0,55	0,03	0,60	0,03	0,70	0,03	10,00	0,50
S2	0,37	0,05	0,37	0,05	0,37	0,05	0,37	0,05	0,38	0,05	0,40	0,05	12,00	1,00
S3	0,50	0,10	0,50	0,10	0,50	0,10	0,55	0,10	0,60	0,10	0,70	0,10	0,60	0,03
S2	0,37	0,05	0,37	0,05	0,37	0,05	0,37	0,05	0,38	0,05	0,38	0,05	0,38	0,05
S3	0,55	0,10	0,55	0,10	0,55	0,10	0,55	0,10	0,60	0,10	0,60	0,10	0,60	0,10

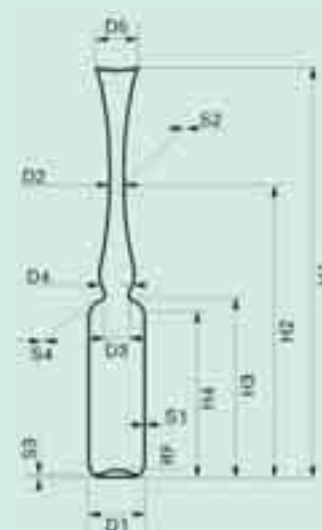

### ACCESSORI - fitments:

- Rompipiale mono e pluriuso in PE / PE single or multi use ampoules breaking device

**A RICHIESTA - ON DEMAND**  
Disponibili anche colorati e serigrafati  
Also available coloured and silkscreen printed





FLACONI A VITE



# FLACONI A VITE



## Flaconi bocca a vite - Screw thread finish vials

### Flaconi passo 13/415 13/415 thread finish vials

Ø x H	Passo/Thread	ml	MPA A x B
16,25 x 37	13/415	3	14 x 35
18,25 x 33	13/415	3	10 x 40
20,25 x 36	13/415	5	13 x 44

Chiusure disponibili - Available closures:

- Capsula 13/415 bianco/nera con guarnizione - 13/415 white or black caps with gasket
- Capsula 13/415 metallizzata con guarnizione - 13/415 metallized cap with gasket
- Contagocce bianco o nero - white or black dropper
- Contagocce metallizzato - metallized dropper

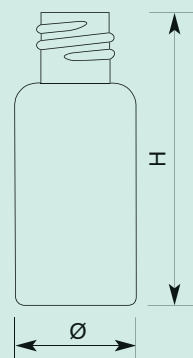

### Flaconi passo EUR 5 EUR 5 thread finish vials

Ø x H	Passo/Thread	ml	MPA A x B
23,25 x 50	EUR 5	10	18 x 55
26,50 x 54	EUR 5	15	23 x 62
29,50 x 54	EUR 5	20	23 x 70
29,50 x 75	EUR 5	30	44 x 70

Chiusure disponibili - Available closures:

- Capsula EUR 5 bianco/nera con guarnizione - EUR 5 white or black caps with gasket
- Capsula EUR 5 metallizzata con guarnizione - EUR 5 metallized cap with gasket
- Contagocce bianco o nero - white or black dropper
- Contagocce metallizzato - metallized dropper

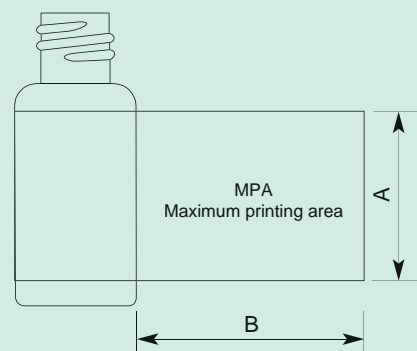

### Flaconi passo 22/410 22/410 thread finish vials

Ø x H	Passo/Thread	ml	MPA A x B
29,50 x 75	22/410	30	44 x 70
34,50 x 61	22/410	30	30 x 82
34,50 x 90	22/410	50	59 x 82

Chiusure disponibili - Available closures:

- Capsula 13/415 bianco/nera con guarnizione - 13/415 white or black caps with gasket
- Capsula 13/415 metallizzata con guarnizione - 13/415 metallized cap with gasket
- Contagocce bianco o nero - white or black dropper
- Contagocce metallizzato - metallized dropper

CONTAGOCCE - DROPPER

CAPSULA - CAP

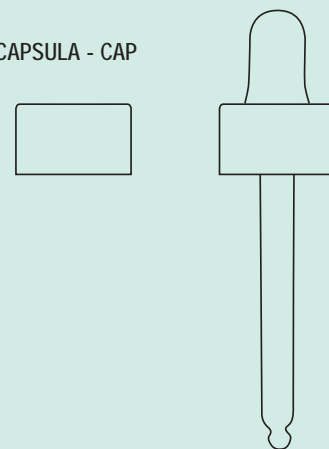

**A RICHIESTA - ON DEMAND**  
Disponibili anche colorati e serigrafati  
Also available coloured and silkscreen printed



FLACONI samples - snap - iso 20 ■■■■

# FLACONI samples - snap - iso 20



## Flaconi - Vials Samples - snap - iso 20

### Flaconi tester profumo - Perfume samples vials

Ø x H	ml	MPA A x B
8,25 x 36	1,2	20 x 20
8,25 x 42	1,4	26 x 20
9,25 x 44	2,0	28 x 22
9,25 x 47	2,2	31 x 22
9,25 x 58	2,7	42 x 22



Chiusure disponibili - Available closures:

- Tappo con clip - cap with clip
- Tappo senza clip - cap without clip

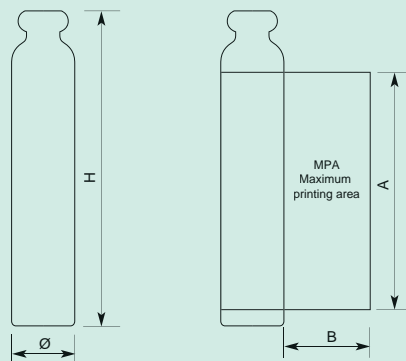

### Flaconi snap - Snap vials

Ø x H	Passo/Thread	ml	MPA A x B
14,25 x 40	B4	3	20 x 30
14,25 x 54	B4	5	34 x 30
14,25 x 80	B4	7	40 x 30
16,25 x 48	B4	5	28 x 40



Chiusure disponibili - Available closures:

- Snap

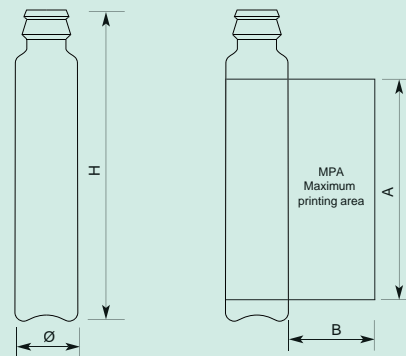

### Flaconi ISO 20 - ISO 20 vials

Ø x H	ml	MPA A x B
22,00 x 40,00	5	16 x 50
22,00 x 44,00	7	20 x 50
22,00 x 50,00	10	26 x 50
24,00 x 45,00	10	22 x 60
24,00 x 55,00	15	32 x 60
30,00 x 55,00	20	28 x 70



Chiusure disponibili - Available closures:

- CAPSULA CLIC 20 - CLIC 20 cap
- Capsula strappo totale - Total tear-off cap
- Dosatore SUC - SUC dosing cap
- Nebulizzatore TBK - MCL 130 - TBK Spray dispenser - MCL 130
- Dispenser Liposomi MCL 190 - TBL - TBL Liposomal dispenser MCL 190
- Cappuccio per dispensers TZ - Dispensers caps TZ

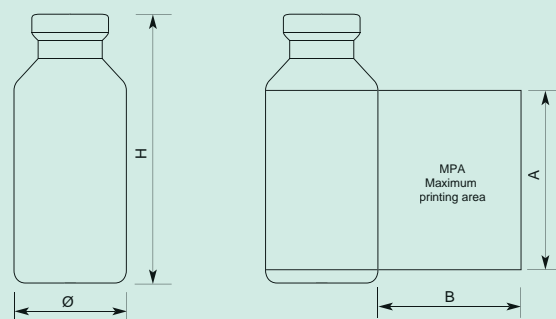

**A RICHIESTA - ON DEMAND**  
Disponibili anche colorati e serigrafati  
Also available coloured and silkscreen printed





ROLL-ON / SPRAY



# ROLL-ON / SPRAY



## ROLL - ON LOOK - SPRAY

Ø x H	Passo - Thread	ml	MPA A x B
14,25 x 50	EUR 3	4	25 x 38
14,25 x 60	EUR 3	5	35 x 38
14,25 x 80	EUR 3	7	55 x 38
14,25 x 100	EUR 3	10	75 x 38

## ACCESSORI - Fitments

Codice - Code	Descrizione - Description
CV40	Porta biglia naturale + biglia PP - natural ball fitment + PP ball
CV41	Porta biglia naturale + biglia INOX - natural ball fitment + INOX ball
CV56	Porta biglia bianco + biglia PP - white ball fitment + PP ball
CV39	Porta biglia bianco + biglia INOX - white ball fitment + INOX ball
CV57	Porta biglia nero + biglia PP - black ball fitment + PP ball
CV43	Porta biglia nero + biglia INOX - black ball fitment + INOX ball
TR47	Capsula in PP bianco - white PP cap
TR52	Capsula in PP nero - black PP cap
TRM15/TRM18	Capsula metallizzata lucida - shining metallized cap
TRM25	Capsula metallizzata opaca - matt metallized cap
TA/SMALL	Pompa spray neutra EUR 3 con cappuccio ml 0,06 natural spray pump with cap - neck EUR3 - ml 0,06

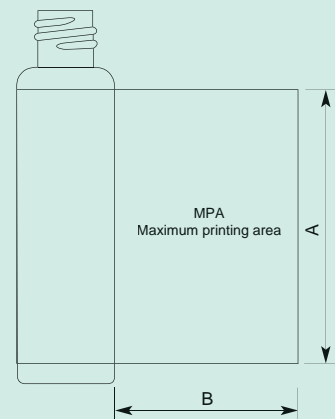
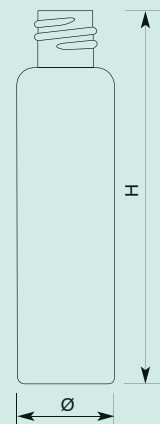

## ROLL - ON SUPER LOOK

Ø x H	Passo - Thread	ml	MPA A x B
20,25 x 41	EUR 5	5	12 x 54
20,25 x 55	EUR 5	7	26 x 54
20,25 x 65	EUR 5	10	36 x 54
20,25 x 86	EUR 5	15	57 x 54
20,25 x 110	EUR 5	20	81 x 54

## ACCESSORI - Fitments

Codice - Code	Descrizione - Description
CV44	Porta biglia naturale + biglia PP - natural ball fitment + PP ball
CV42	Porta biglia naturale + biglia INOX - natural ball fitment + INOX ball
TR26	Capsula in PP bianco - white PP cap
TR39	Capsula in PP nero - black PP cap
TR49	Capsula in PP naturale - natural PP cap
TR40	Capsula platino - platinun cap
TRM20	Capsula metallizzata lucida - shining metallized cap
TRM26	Capsula metallizzata opaca - matt metallized cap

ROLL-ON

SPRAY

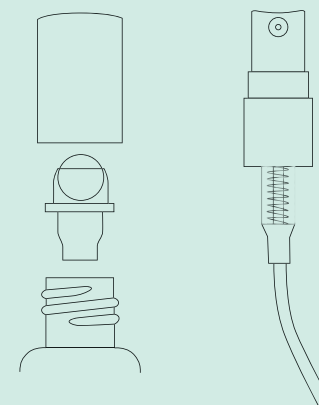

**A RICHIESTA - ON DEMAND**  
Disponibili anche con fondo arrotondato, colorati e serigrafati - Also available with round bottom, coloured and silkscreen printed

N ROUND 100

N ROUND 50



## Round Glass

Flacone in vetro da stampo, disponibile da 50 e 100 ml bocca 24/410

*Mould glass bottle, available in 50 ml and 100 ml, neck 24/410*

### CHIUSURE ABBINABILI / AVAILABLE CLOSURES:

24 C\* - TAK+TVK - Tlerc+TV - TL+TV - TA+TV oppure/or TU - RU - RE - RZ - RV

\*Dispenser spray con cannula erogatrice/safe

24/410 colore bianco erogazione 0,25 ml

\* *Spray dispenser with safety dosing tube*

*Mouth 24/410, white colour dosing 0,25 ml*





## Luxury Vial

Flacone in PE neutro, filetto standard, completo di dosatore in PP bianco o metallizzato e chiusura a vite.

Disponibile nelle versioni da:  
3 - 5 - 7 - 10 - 15 ml

*Bottle in natural PE, standard thread, complete with white or metallized PP dosing cap and screw closure.*

*Available in the following references:  
3-5-7-10-15 ml*

## Luxury Box

Supporto in ABS a sezione quadrata o ellittica per il contenimento dei Luxury Vials da 3 - 5 - 7 e 10 ml

*ABS support packaging with squared or elliptical section for luxury vials (3-5-7-10 ml)*



CUSTOMER CARE



Carlotta Ricchetti  
Skype: carlotta.vimepack

CUSTOMER CARE



Elisabetta Brozzi  
Skype: elisabetta.vimepack

SALES MANAGER



Nadia Procopio  
Skype: nadia.vimepack