



BOREHOLE

DIRECTIONAL CORE DRILLING
BOREHOLE SURVEYING
INSTRUMENTS

POSITIONING SOLUTIONS





About Devico

THE SMART WAY

Devico is a Norwegian company specializing in directional core drilling for the mining and tunneling industry. We help our customers with equipment and services for steering their boreholes in the direction they actually want.

Devico has head office in Trondheim, Norway and branch offices in Hong Kong, Bulgaria, South-Africa and Brazil. The company was established in 1988, and our engineers have many years experience in this industry.

In addition to Devico's in-house team, Devico products are represented by sales agents in all the major markets around the world.

QUALITY ASSURANCE

We are committed to our quality assurance program to ensure we keep our customers satisfied. All equipment sent for field work has been through extensive testing in our renovated and extended workshop. The workshop is equipped with instruments for surface testing of the DeviDrill, calibration jigs for the survey tools and a test hole facility.

CREATIVE SOLUTIONS

At our head office in Norway we are continuously improving our products so that we will always offer the most efficient solutions for the mining and tunneling industry. We have skilled developers within our mechanic, electronic and software departments, who work together to provide the best products possible for our customers. Devico has several products patented worldwide.

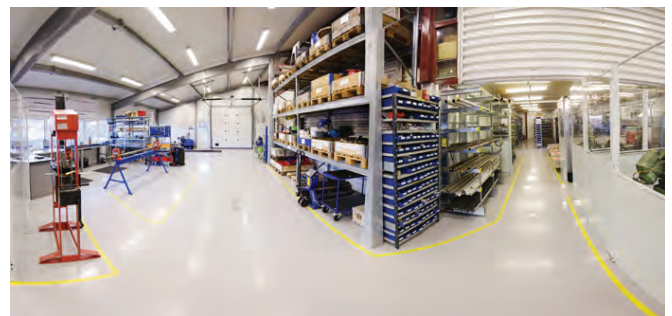

State of the art workshop



Devidrill project



Directional Core Drilling

Core drilling is extremely valuable as an exploration method. But certain aspects make it slow and more expensive than necessary. Often, long sections must be drilled before reaching the target formation. In addition, natural deviation can change the drill path and reduce the value of the borehole.

With the Devico technology you can complete a drilling program quicker, and with higher accuracy than with traditional core drilling methods.

Devico technology makes it possible to control borehole deviation and steer the hole accurately towards the target. At the same time, core samples are collected during the steering process. When the first hole is finalized it can be sidetracked and used again to steer towards a second target. Sidetracking is easily performed by cutting straight in a curved section of the first hole. By using this method no wedges or cement plugs are necessary. Making several branch holes may significantly reduce the length of a drilling program, leading to remarkable savings in both time and money.

Devico technology has been used successfully all around the world. Our experience tells us you will be surprised by how easily directional core drilling can be implemented in your drilling program.

The quality of your geological information will improve for a fraction of the price, and with less impact on the environment!

To ensure rapid and trouble-free implementation with cost saving into any drilling program, directional core drilling with the DeviDrill is offered as a service to our clients throughout the world, performed by highly trained and experienced DeviDrill field operators.

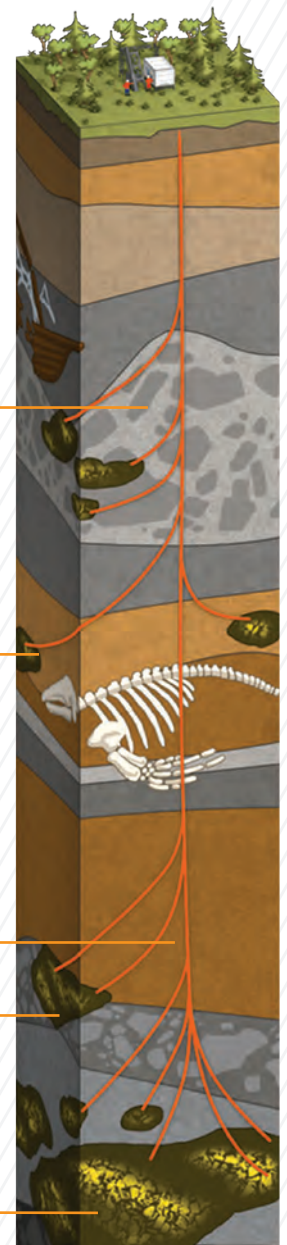

SIDETRACKING WITHOUT CEMENT PLUGS OR WEDGES

4 DAYS
SAVED
PER BRANCH

HIGH ACCURACY

12 DAYS
SAVED
PER BRANCH

26 DAYS
SAVED
PER BRANCH

IMPROVED GEOLOGICAL INFORMATION

MULTIPLE BRANCHES

34 DAYS
SAVED
PER BRANCH

EXTREME DEEP HOLE CAPACITY (3000 M. +)

BENEFITS

There are many benefits using DCD in your exploration project. A few of them are listed here.

Compared to standard wireline drilling (re-drilling from surface)

- Reduced drilling length
- Less wear on drilling equipment
- Fewer drill sites
- Less environmental impact
- Full control over natural deviation
- Improved borehole accuracy

Compared to other directional drilling techniques

- Core in directional sections
- Low water consumption
- All necessary equipment in small start package
- Fits directly on NWL drill string
- High penetration rate in hard rocks
- Easily adjustable dogleg
- Higher dogleg used due to smoother curve
- Drill string rotation also during steering
- Directional surveys performed at hole bottom (throughout DeviDrill bit)
- Full N-size borehole and no additional reaming required

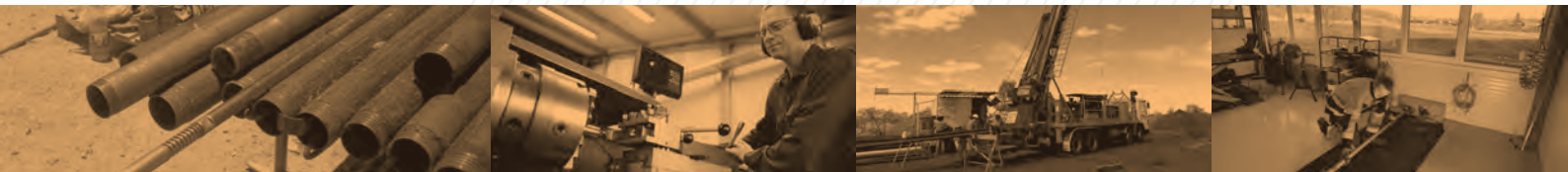

Directional core drilling

DeviDrill

The **DeviDrill** is a steerable wireline core barrel. The design of the N-size tool was introduced in 2001. Today it is successfully applied in various projects all over the world, from mineral exploration to geotechnical investigations.

The **DeviDrill** reduces the cost of exploration drilling programs by hitting targets quicker significantly and more accurately than with traditional core drilling methods. By making multiple branches from one mother hole it dramatically reduces both the time and the cost spent. In addition, you get the geological information from where you want. No time is lost on moving the drill rig, drilling through the overburden, and drilling further down to where you almost were with your previous hole.

HOW IT WORKS

The principle behind the tool is a drive shaft running through a bushing offset from the centre line of the tool. Expanding pads operated by a differential pressure keeps the **DeviDrill** in a fixed Tool face while drilling in a curve. The inner assembly carries an inner tube collecting the core, a muleshoe system, and an instrument barrel with the survey tool recording inclination and tool orientation. Data is stored inside the tool and downloaded to a PDA after each run.

There is no need to trip drill rods in and out of the hole during directional coring, surveying and orientation, as the tool is wireline operated.

The **DeviDrill** has proved to work well in both igneous and sedimentary rock. Over time, Devico has developed extensive knowledge of how the **DeviDrill** behaves under different conditions and provides valuable experience in directional planning and drilling.

TECHNICAL SPECIFICATIONS

Total weight	87 kg/192 lbs
Total length	5400 mm/17.7 ft
Core length	3000 mm/9.8 ft
Core diameter	31.5 mm/1.240"
Bit diameter	75.4 mm/2.969"
Reamer diameter	75.6 mm/2.976"
Tool body diameter	72.0 mm/2.835"

More Technical Specifications on page 15

**DOGLEG
SETTINGS**

**SPECIAL DEVICO
DIAMOND BIT**





LOCKING COUPLING

THRUST UNIT

SLIDING PACKER

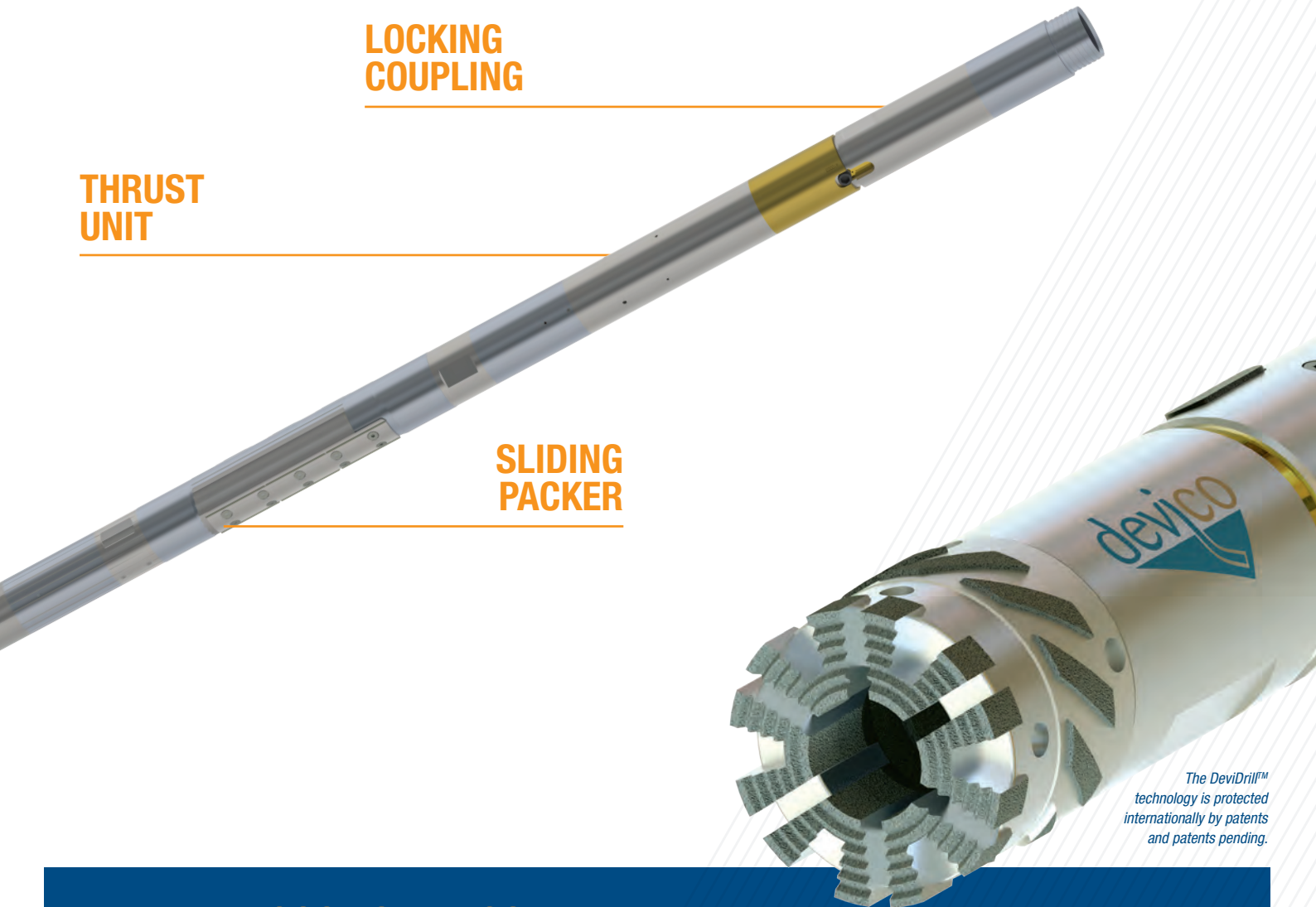

The DeviDrill™ technology is protected internationally by patents and patents pending.

TIME AND COST SAVINGS



Clients have reported time and cost savings of up to 80 percent in projects where the **DeviDrill** was used. A satisfied geologist stated: “Devico forced the hole down in inclination, and the 1000 meter deep hole switched from total failure to great success.”

The **DeviDrill** uses a normal drill string and is fully compatible with the N-size wireline systems. There is no need for additional water pumps, drill strings, or survey instruments. Devico's survey tools are a fully integrated part of the tool, as they stay on board and measure while drilling.

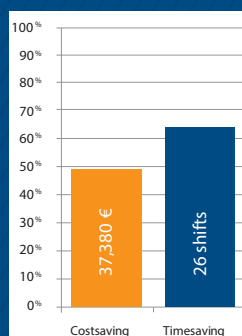
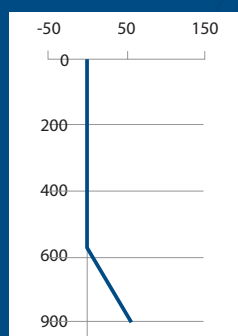

Coring during steering provides a complete record of the geology. It leaves nothing in the hole - except a bend. The curvature or dogleg can be adjusted from straight to more than 20 degrees/30 meters. However, the recommended curvature from the drill rod manufacturer is 9 degrees/30 meters, as any greater deviations can result in extensive wear on the drill rods



Non-magnetic survey tools

DeviFlex

Non-magnetic multishot

If you know how to run your inner tube, you know how to run your *DeviFlex*.
It is that easy.

DeviFlex is a non-magnetic electronic multishot for surveying inside casings and drill strings by simply using the wireline system. Magnetic disturbances will not influence the tool at all, and its design makes it very easy to use. Just pump the tool into the hole and pull it out in given intervals. No adjustments are necessary.

The *DeviFlex* tool consists of two independent measuring systems. Three accelerometers and four strain gauges are used to calculate inclination and change in azimuth. In addition, the *DeviFlex* records and stores gravity vector, temperature, and battery capacity.

The *DeviFlex* fits casings and drill strings from B-size and up to H-size. You need one instrument and a set of sleeves with various wheel sizes to adjust for different hole dimensions. The tool has proven to work in horizontal as well as vertical holes.

The *DeviFlex* communicates with a PDA through a USBmodem. The results can be viewed on the PDA screen in the field once the data is downloaded from the tool. The data can thereafter be further processed in *DeviSoft*, analyzed, plotted and reported to the client or given directly to the client on a memory stick.

TECHNICAL SPECIFICATIONS

Weight	20 kg/44 lbs
Diameter	40 mm/1.58"
Length	4000 mm/13.1 ft
Magnetic	No
Running gear	Integrated
Inclination accuracy	$\pm 0.1^\circ$
Direction accuracy	$\pm 0.01^\circ$ pr station
Tool face accuracy	$\pm 0.2^\circ$



**NON-MAGNETIC
MEASUREMENT**

**BWL, NWL, HWL
CENTRALIZERS**

**SURVEY INSIDE
DRILL RODS**

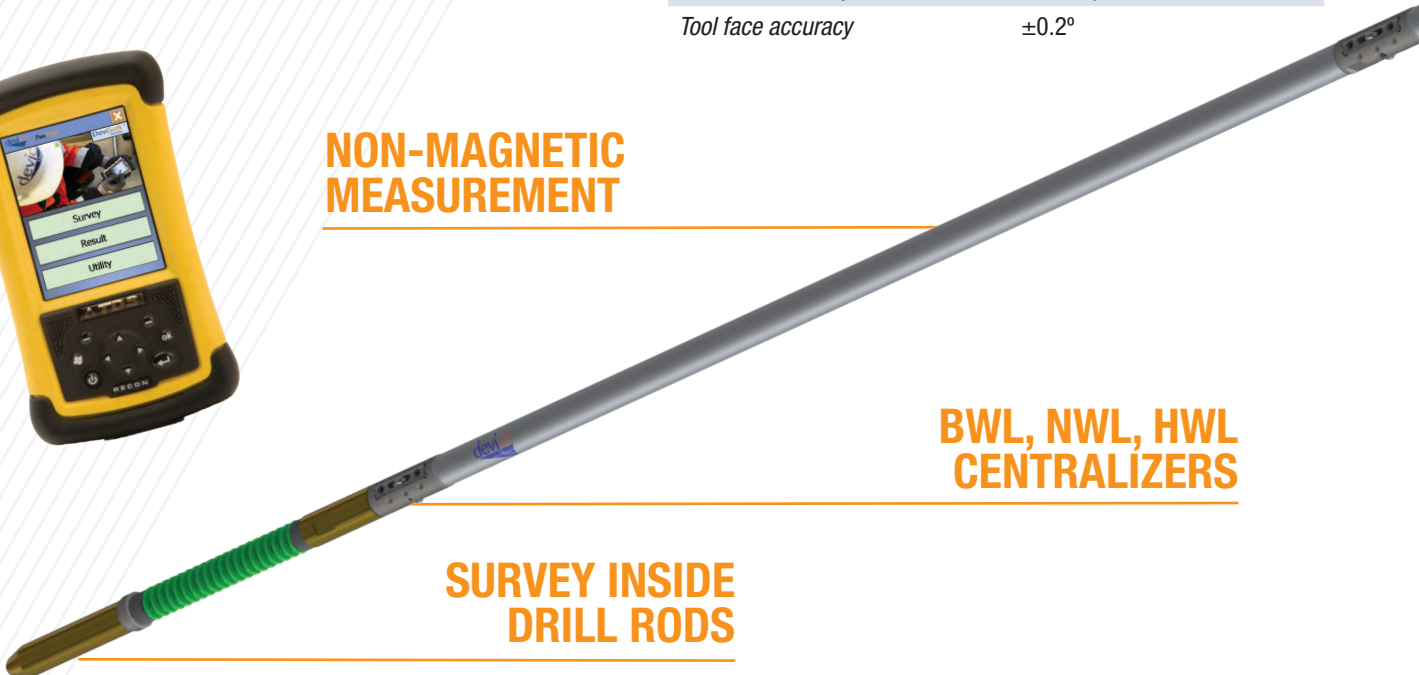



**SPEAR HEAD
ADAPTER**

**RUNNING
LIKE AN
INNER TUBE**

**UP TO 400 HOURS
BATTERY CAPACITY**



Vertical orientation

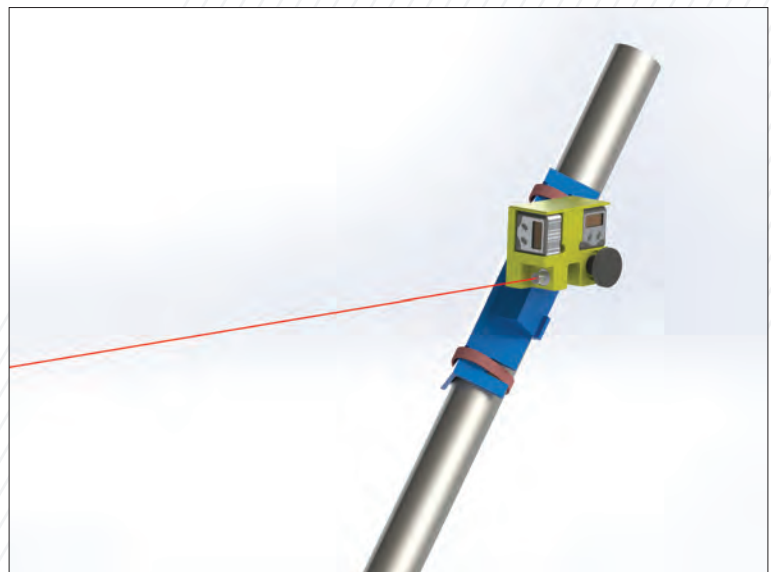

Collar Azimuth Laser, makes it easier to measure borehole start azimuth and inclination accurately.



Magnetic survey tools DeviShot

The most innovative multishot survey tool on the market.

This NEW versatile rugged instrument features a low voltage wireless communication system with Brilliant Blue Technology (BBT), a robust integrated running gear, limited maintenance, quality control of survey data, LED indicator for communication, battery control.

The **DeviShot** is designed with user-friendliness in mind and comes assembled and ready for use straight from the box. The integrated running gear enables operation at great depths, while an efficient BBT activation system ensures minimal power consumption and long battery life.

The **DeviShot** comes equipped with the IP67 rated Nomad PDA system and the highly flexible **DeviSoft.Mobile** software. It can be used in most situations and will for instance easily operate as single shot, multi shot, with constant or variable depth interval, and for surveying in and/or out. The instrument is ready to go as it is, regardless of whether you want to survey exploration boreholes, grout curtains or blast holes.

The **DeviShot** is using Brilliant Blue Technology to communicate wirelessly with the PDA and the results can be viewed on the PDA screen in the field once the data is downloaded from the tool. The results can thereafter be transferred to a USB-memory stick and given to the client, or further processed in **DeviSoft**, analyzed and plotted.

TECHNICAL SPECIFICATIONS

Weight	5.7 kg/12.6 lbs
Diameter*	35 mm/1.38"
Length	1170 mm/46.1"
Magnetic	Yes
Running gear	Integrated
Inclination accuracy	±0.1°
Azimuth accuracy	±0.5°
Tool face accuracy	±0.2°

*Also available in 30 mm.

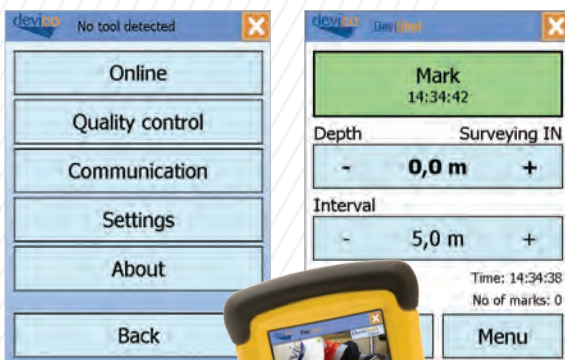

Depth	Az	Incl	Northing
0.0	26.83	-0.20	0.00
5.0	26.86	-0.21	4.46
10.0	26.84	-0.27	8.92
15.0	26.86	-0.21	13.38
20.0	26.85	-0.22	17.84
25.0	26.48	-0.20	22.31
30.0	26.90	-0.20	26.78
35.0	26.86	-0.18	31.24
40.0	26.82	-0.17	35.70

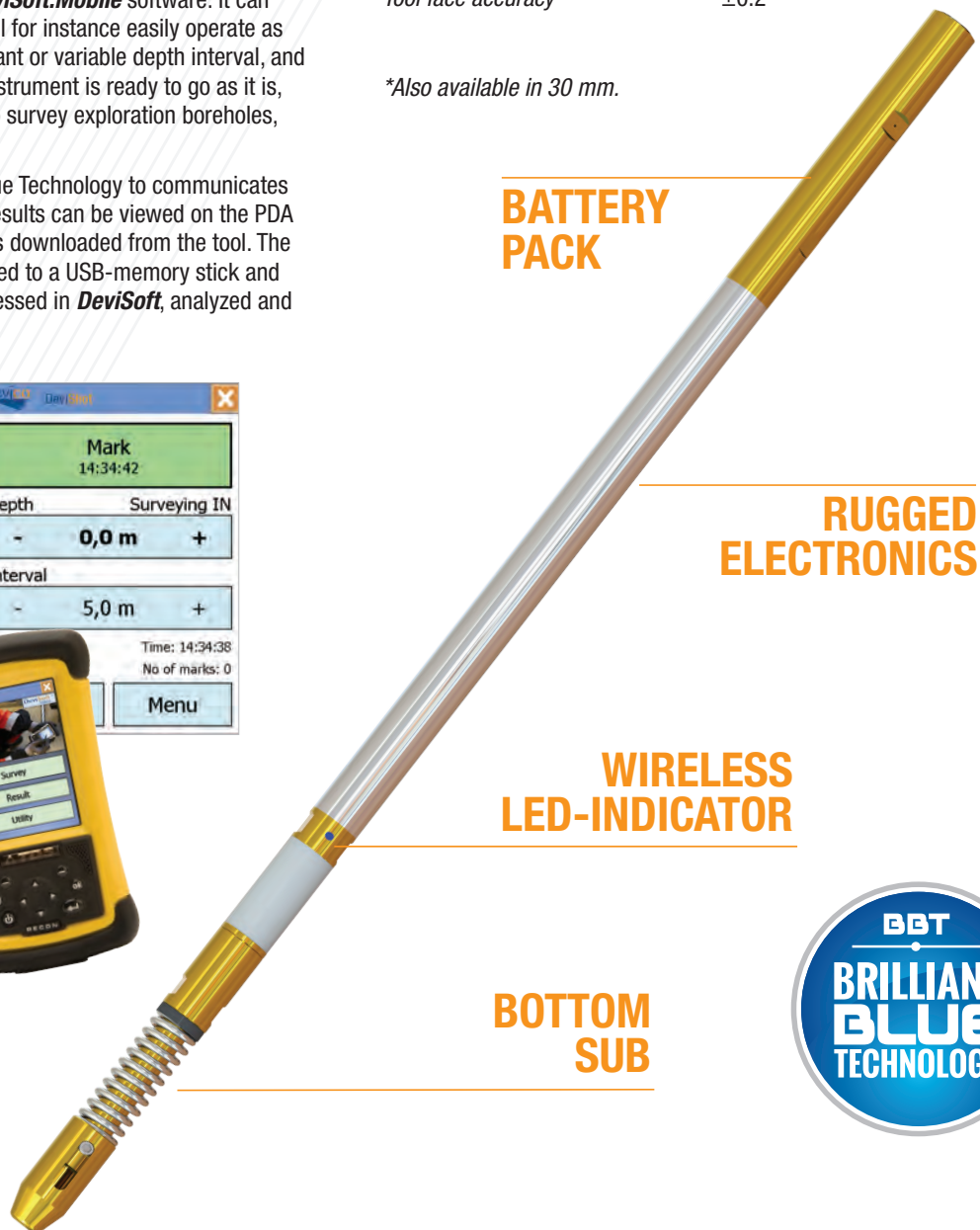

BATTERY
PACK

RUGGED
ELECTRONICS

WIRELESS
LED-INDICATOR

BOTTOM
SUB



Rugged single and multishot system

DeviTool Standard

The original model from Devico with a separate running gear.

DeviTool Standard is an electronic single or multishot survey instrument. Its rugged design makes it tough enough to stay inside the **DeviDrill** core barrel while drilling and still provide reliable results. The **DeviTool Standard** uses three high-accuracy magnetometers and accelerometers. The tool records inclination, azimuth, toolface, gravity vector, magnetic field vector and magnetic dip angle, as well as temperature and battery status. Time intervals can be set from 5 seconds and up. The **DeviTool Standard** performs all-angle surveys with high precision. The survey tool is delivered in an interchangeable running gear where all parts are included. The connector port in the running gear makes the download of survey results fast and easy. It is delivered in a transport box that is easy to carry around. The tool has been successfully used in a broad variety of applications all over the world.

The **DeviTool Standard** communicates with the PDA through a USB modem and the results can be viewed on the PDA screen in the field once the data is downloaded from the tool. The results can thereafter be transferred to a USB-memory stick and given to the client, or further processed in **DeviSoft**, analyzed and plotted.

Available with 36mm or 38mm brass running gear.

TECHNICAL SPECIFICATIONS

<i>Weight</i>	8.8 kg/19.4 lbs
<i>Diameter</i>	36 mm/1.41" & 38 mm/1.50"
<i>Length</i>	1900 mm/74.8"
<i>Magnetic</i>	Yes
<i>Running gear</i>	Integrated
<i>Inclination accuracy</i>	±0.1°
<i>Azimuth accuracy</i>	±0.5°
<i>Tool face accuracy</i>	±0.2°

AZIMUTH & DIP READINGS

FAST DOWNLOAD

BATTERY PACK

SEPARATE RUNNING GEAR

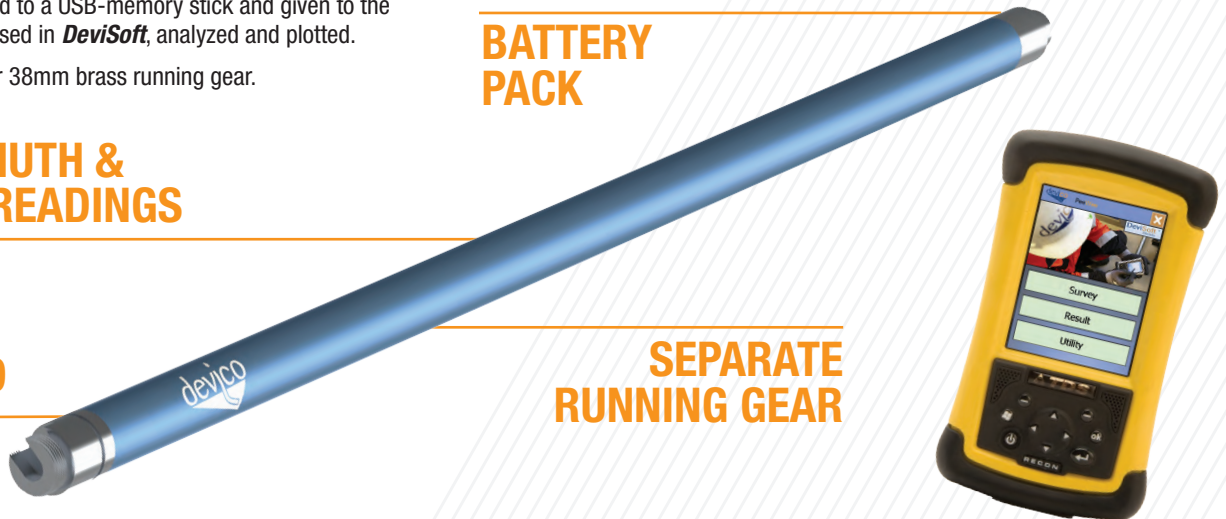

RUNNING GEAR WITH COM-PORT

In order to get the best out of your **DeviTool** instrument you need a running gear. The Devico running gear can handle up to 450 bars of pressure and meets industry standards.

The running gear fits most 30 mm diameter survey tools on the market. The **DeviTool** can stay inside the running gear during download of data because of the special connector port.

	DIAMETER 36 MM/1.43"		DIAMETER 38 MM/1.50"	
<i>Length</i>	1900 mm/6.6 ft	2400 mm/7.9 ft	11900 mm/6.6 ft	2400 mm/7.9 ft
<i>Weight</i>	7.5 kg/16.5 lbs	8.1 kg/17.9 lbs	9.5 kg/20.9 lbs	10.2 kg/22.5 lbs
<i>Pressure</i>	160 bar/2320 psi	160 bar/2320 ps	450 bar/6525 psi	450 bar/6525 psi



Core orientation DeviCore BBT

Efficiency and reliability all in one

The **DeviCore BBT** is the latest core orientation innovation from Devico. The **DeviCore BBT** represents an integration of the patent pending Brilliant Blue™ technology and other proprietary Devico technologies. The **DeviCore BBT** employs the same **DeviDip** system probe technology which has proven to be an industry leader in reliability for more than 10 years as a part of the **DeviDrill**, combining electronic core orientation integration with brand new ergonomic running gear. It was developed to be user friendly and efficient, keeping the influence on the daily production rates at a minimum.

The kit includes two **DeviCore BBT** probes and a core barrel extension and is ready to be assembled on the drilling equipment on site. The probes also has a valve system in front securing that pump-in time is not affected.

DeviCore BBT comes equipped with the IP67 rated Nomad PDA system and **DeviSoft.Mobile** software. The operation follows a clear step-by-step procedure, and one probe can be started and downloaded while the other is down in the hole.

DeviCore BBT uses three high-accuracy accelerometers, it measures inclination, orientation, gravity vector, temperature and battery status, and offers quality control on the results.

Communication between **DeviCore BBT** and the PDA is done wirelessly via Brilliant Blue Technology.

TECHNICAL SPECIFICATIONS

Weight [kg/lbs]	5.7/12.6
Diameter [mm/in]	*
Length [mm/in]	500/19.7
Magnetic	No
Running gear	Integrated
Inclination accuracy	±0.1°
Orientation accuracy	±0.5°

*Available in BWLTK, NWL, NWLTK, HWL and PWL.

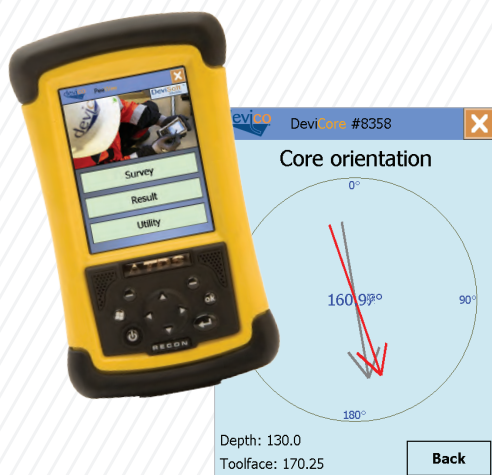

The rock core is orientated at the surface when the two arrows are aligned.

DIP MEASUREMENT

MEASURE WHILE DRILLING

QUICK MEASUREMENT





Dip Measurement System

DeviDip

If you know what you need, it is unnecessary to pay for additional features.

The **DeviDip** electronic multishot offers a simple and efficient solution for measuring inclination angles. The rugged design even makes it possible for the tool to stay with the core barrel while drilling.

When fitted in the belonging survey barrel the **DeviDip** attaches directly to the inner tube spear head, meaning surveys can be performed during the drill run. This configuration makes it possible to monitor borehole inclination with minimal to no impact on the drilling process.

Besides being an independent survey tool the **DeviDip** is used as a steering tool for the **DeviDrill**. It can also be used as an orientation device for other equipment, such as wedges and downhole motors.

The **DeviDip** uses three high-accuracy accelerometers to perform the measurements. The tool measures inclination, Tool face, gravity vector, and temperature and battery status. Time intervals can be set from 5 seconds and up.

The **DeviDip** communicates with a PDA, and the results can be viewed on the PDA screen in field once the data is downloaded from the tool. The results can thereafter be transferred to a USB-memory stick and given to the client.

TECHNICAL SPECIFICATIONS

Weight [kg/lbs]	0.34/0.75
Diameter [mm/in]	30/1.18
Length [mm/in]	230/9.03
Magnetic	No
Running gear	Required
Inclination accuracy	±0.1°
Tool face accuracy	±0.2°
Inclination range	-90° – +90°

SPEAR HEAD ADAPTER

SWIVEL

MEASURE INCLINATION WHILE DRILLING

VERY ACCURATE DIP CONTROL



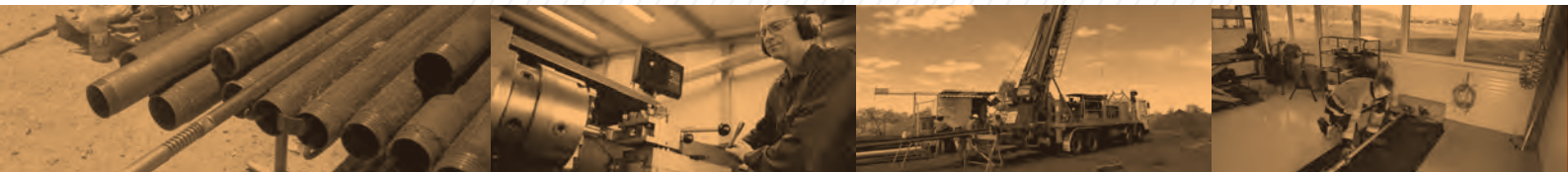

Software

DeviSoft Mobile

DeviSoft Mobile is Devico's PDA software which operates all Devico tools. The software will automatically detect which of the Devico tools is connected. Just plug and play. Direct access to the results after downloading, a plot function of the borehole in different angles, and possibilities for multiple surveys without downloading are some of the functions supported. The software is translated to several languages.

DeviSoft Mobile comes preinstalled on the PDA delivered by Devico. Software updates are made available on www.devico.com.

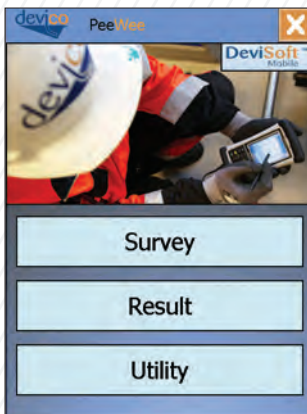

Main screen

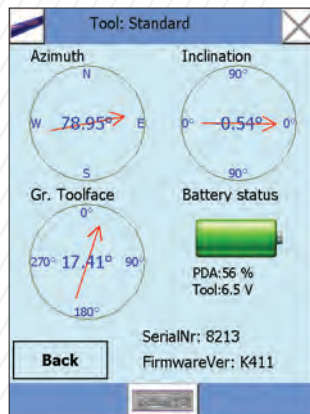

Online screen

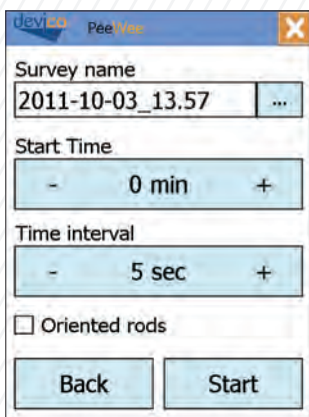

Input parameter

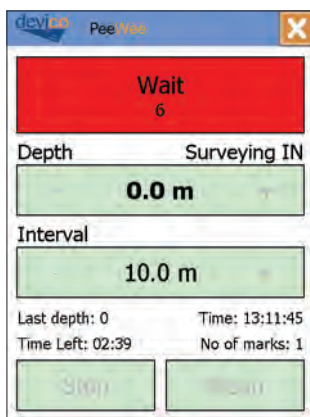

Registration of measurement

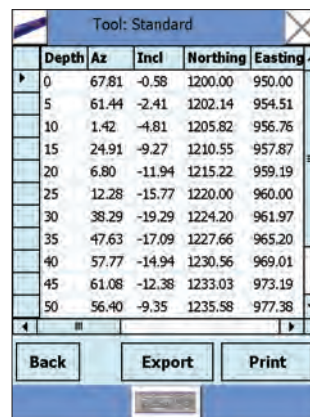

Results including quality control

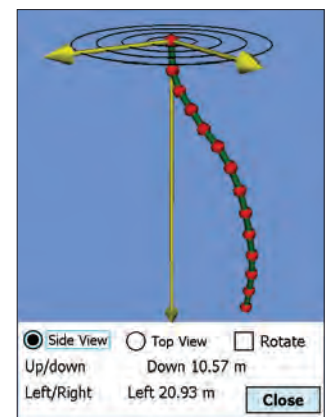

Plot the results immediately



Software

DeviSoft

Borehole software for PC

DeviSoft is software used in directional drilling and traditional borehole surveying. The software is flexible, and covers the needs of a directional driller or a borehole surveyor, as well as the planning and surveying of blast holes and grouting curtains.

The **DeviSoft** will at any position in the hole provide you with the setting of the **DeviDrill**, such as Tool face, dogleg and the drilling distance necessary to hit the specified target. You can import 3D coordinates from your ore body or rock face, calculate the distance from the profile to the hole and plot the entire situation.

The planning of curved holes is linked to the capabilities of the drill tool. The starting position may be specified or calculated. Target coordinates are specified along with the dogleg rate. The calculation supplies azimuth, inclination, coordinates, and drill Tool face setting for specified intervals along the curved section of the hole.

The measured depth, azimuth, and inclination of boreholes may be entered manually, imported from files, or transferred from a PDA.

Various analysis of deviation from corresponding planned holes may be performed and the results plotted on the screen or listed in tables.

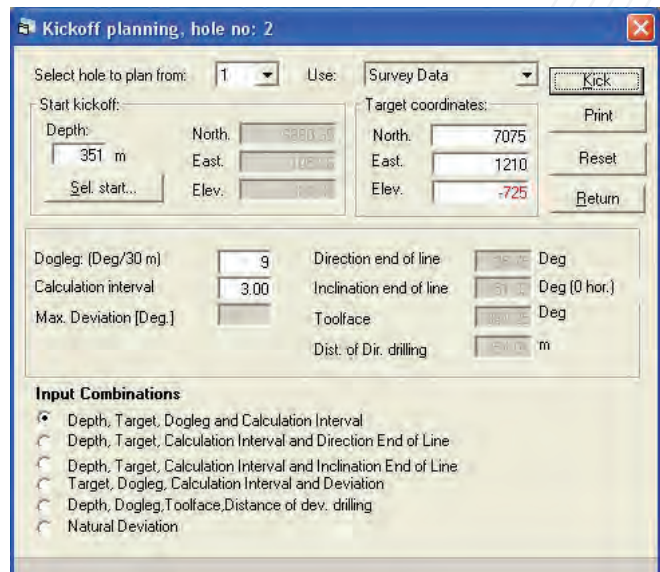

- Plan drill holes for exploration program, blasting, grout curtains, multiple wells with target drilling and directional drilling.
- Calculate, analyze, and report borehole surveys.

System requirements: Windows XP, Windows 7
Hard disk: Min. 50 MB free.

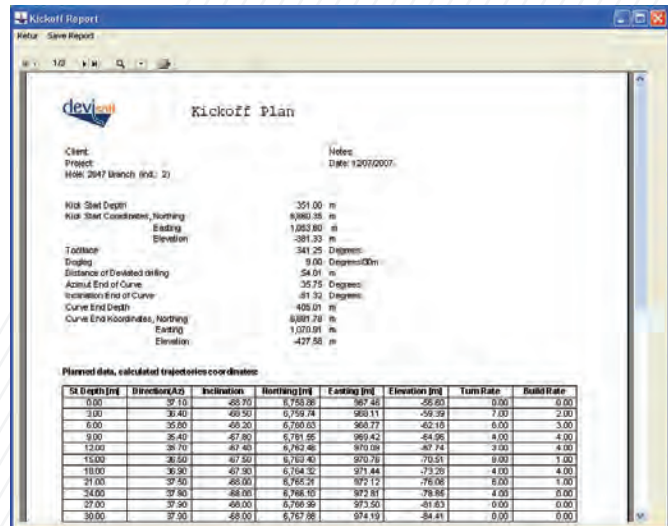



Test facility

Devico test facility

Devico has great test facilities for borehole survey tools right out of the workshop. Two boreholes of 250 meters and 150 meters are accessible all the year. The longest borehole is standard N-size. The borehole has a varying curvature, from practically straight to sections with a high dogleg. The borehole is a good challenge for all types of non-magnetic survey tools.

The 140 meter long borehole is made of plastic tubes, and is very suitable for testing magnetic survey tools. The two boreholes give Devico and all other interested a chance to test almost all types of survey tools. The test holes have a known trajectory and open exit points.

TECHNICAL SPECIFICATIONS

<i>Length</i>	245 / 140 meter
<i>Diameter</i>	60 mm / 50 mm
<i>Location</i>	Melhus, Norway
<i>Constructed</i>	Summer 2009



TECHNICAL SPECIFICATIONS DIRECTIONAL CORE DRILLING

Total weight	87 kg / 192 lbs	Instrument barrel length	1.6 m / 5.2 ft
Total length	5.4 m / 17.7 ft	Instrument barrel diameter	51 mm / 2.01"
Length front section	3.2 m / 10.5 ft	Pumping/latching unit	Standard Longyear NQ™
Weight front section	47 kg / 104 lbs	Landing ring	Standard Longyear NQ™
Length rear section	2.2 m / 7.2 ft	Landing indication	Yes
Weight rear section	23 kg / 51 lbs	Core block indication	Yes
Bit diameter	NWL	Pull out by-pass valve	Yes
Reamer diameter	NWL	Use of additives	Optional
Tool body diameter	72.0 mm / 2.83"	Dogleg severity (DLS)	0-20°/30 m / 0-20°/100 ft
Core diameter	31.5 mm / 1.24"	Differential pressure	20 bar / 290 psi
Core length	3 m / 9.8 ft	Operating pressure	20 bar + circulation pressure
Length inner assembly	5.4 m / 17.7 ft	Feeding force (max)	4500 kg / 9900 lbs
Weight inner assembly	17 kg / 37 lbs	RPM	300-1200

RECOMMENDED PARAMETERS

Dogleg severity, NWL rods	9° pr. 30 m / 9° pr. 100 ft (180 m / 590 ft radius)
RPM	300 - 800
Feeding force (Bit weight + sliding force)	1500 - 2500 kg
Typical penetration rate	3 m/h / 10 ft/h
Typical production rate	9 - 27 m/12 h / 30 - 90 ft/12 h (50% - 75% of conventional wireline drilling)

TECHNICAL SPECIFICATIONS BOREHOLE SURVEYING TOOLS

	DEVISHOT • STANDARD	DEVICORE II	DEVIDIP	DEVIFLEX
Weight [kg/lbs]	5.6/12.6 • 8.8/19.4	2.8/6.20	0.34/0.75	20/44.10
Diameter [mm/in]	35/1.38 • 36/1.41 & 38/1.50	36/1.41	30/1.18	40/1.58
Length [mm/in]	1170/46.1 • 1900/74.8	650/25.59	230/9.03	4000/157.48
Memory [readings]	5000 • 1920	1920	1920	1920
Operational temperature	-10/+60 °C	-10/+60 °C	-10/+60 °C	-10/+60 °C
Pressure [bar/psi]	450/6525 • N/A	300/4350	NA	300/4350
Magnetic	Yes	No	No	No
Running gear	Integrated • Required	Integrated	Required	Integrated
Azimuth accuracy	±0.5°	NA	NA	±0.01° pr station
Typical vertical accuracy	NA	NA	NA	0.07 % *
Typical sideways accuracy	NA	NA	NA	0.16 % *
Inclination accuracy***	±0.1°	±0.1°	±0.1°	±0.1°
Tool face accuracy***	±0.2°	±0.2°	±0.2°	±0.2°
Temperature	Recorded	Recorded	Recorded	Recorded
Magnetic vector	Recorded	NA	NA	NA
Magnetic dip	Recorded	NA	NA	NA
Azimuth range	0°-360°	NA	NA	0°-360°
Inclination range	-90°- +90°	-90°- +90°	-90°- +90°	-90°- +90°
Sum inclination	No	No	No	Yes
Battery data	2x 3.6V Lithium	2x 3.6V Lithium	2x 3.6V Lithium	6x 3.6V Nimh
Battery capacity**	1200 • 400 hours	450 hours	450 hours	400 hours Rechargeable
Data communication	Wireless or Cable • Cable	Cable	Cable	Cable
Baud rate	115000 • 9600 bps	9600 bps	9600 bps	9600 bps
Main area of use	Open hole survey	Core/Tool orientation	Dip measurement/ Tool orientation	Survey inside casing/ drill string

* Percent of hole length

** Battery capacity is measured with 5 sec interval.

*** Accuracy calibrated for temperature range -10°C to +60°C



HEAD OFFICE – NORWAY

Devico AS

Drammensvegen 55, 7224 Melhus

Norway

Phone: +4772 87 01 01

Fax: +47 72 87 01 11

devico@devico.no

www.devico.com

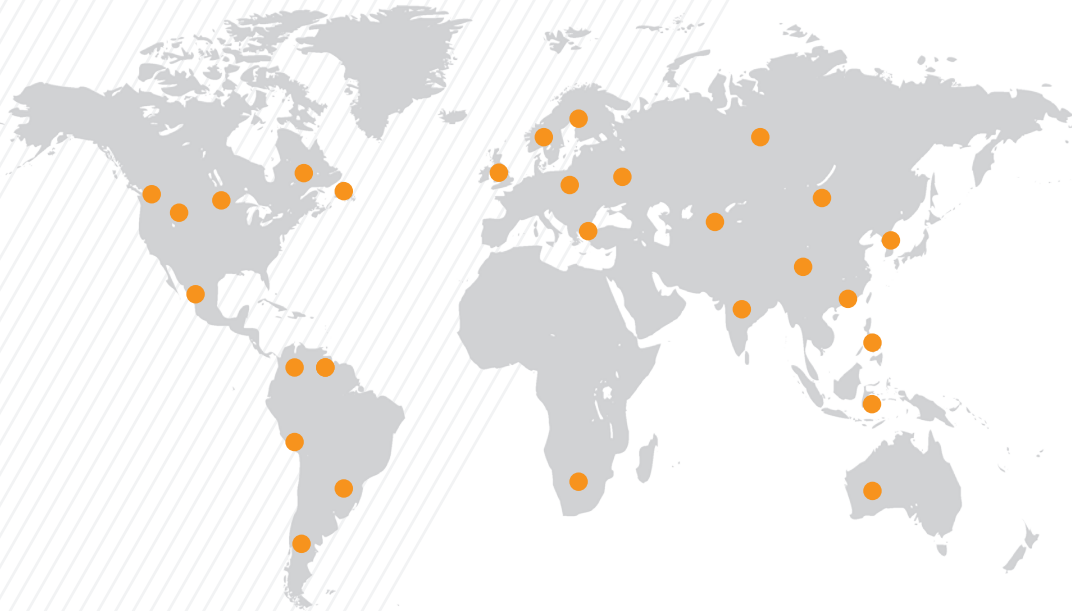

Devico is present in all corners of the World and we invite you to look on our Devico.com website for the latest details of your nearest Devico representative.

Local representative:

GeoMEM Ltd.

Tel: +44 (0)1382 329011 email: james@geomem.com

Web: www.geomem.com

24 John Huband Drive, Birkhill,
Dundee, DD2 5RY, UK

Devico technologies depicted herein are protected internationally by patents and patents pending.