

PICK  
UP YOUR  
**FREE COPY**  
TODAY



**ENDURAMAXX**<sup>®</sup>

# SPRAYERS

SALES CATALOGUE 2014



Product helpline 0800 840 4030

[enduramaxx.co.uk](http://enduramaxx.co.uk)

# WELCOME

Welcome to the new Enduramaxx catalogue where you will find innovative new products and subtle changes to existing products as a result of continuous research and development. As always our focus is value for money and uncompromising quality.

We recommend that you check our website for regular news updates and special offers. You can also keep in touch by subscribing online to our monthly newsletter.

We value any feedback or suggestions for improvement that you may have. You can speak directly to one of our friendly and helpful staff for product advice and support or make contact online.

The Enduramaxx Team



England, Wales & Industrial Scotland - Carriage Paid on all orders over £150

Highlands and Offshore Islands - Please phone for carriage rates

## Carriage Details

All products - Freight Free to your nearest distributor. Remote areas excluded. Enduramaxx are committed to supplying carriage free to your local store in as many areas as possible. In order to achieve this there may be some delays in delivery. Urgent deliveries may incur a freight charge. Please contact us or your local dealer to discuss. Orders less than £150.00 may incur a £7.50 handling charge. England & Wales.

**Disclaimer:** All goods are sold in accordance with our standard terms and conditions for the sale of goods available upon request. All prices exclude VAT. Product specifications and prices are subject to change in line with our commitment to continuous improvement. Capacities and dimensions may vary due to manufacturing process. Colours represented may vary due to printing process.

SPOT SPRAYERS	04
SKID SPRAYERS	08
DUST SUPPRESSION & PLANT WATERING	18
SPRAY BOOMS	23
TRAILER SPRAYERS	28
ON THE GO SPRAYERS	34
ACCESSORIES & PARTS	37
INDEX	51

## Our best sellers at a glance...

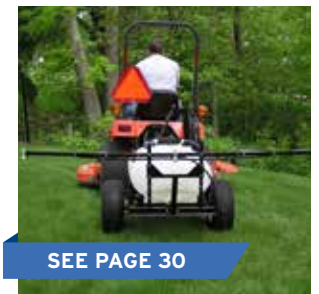



We have a great range of 12V sprayers and booms providing the best value and quality around.



PRODUCT SHOWN  
131000 34L 12V Spot Sprayer

SILVER SERIES SPOT SPRAYERS

Features

- 3.8L/min 40PSI pump
- Metal 12V spray gun with adjustable nozzle
- 2.4m electrical cables with switch and battery clip
- Drain plug in tank for easy cleaning
- Includes attachment straps
- 4.5m hose



SILVER SERIES SPOT SPRAYERS 34-95L



Code	Description	Dimensions in mm
131000	34L 12V Spot Sprayer	475 (L) x 375 (W) x 400 (H)
131015	55L 12V Spot Sprayer	865 (L) x 390 (W) x 345 (H)
131020	95L 12V Spot Sprayer	865 (L) x 390 (W) x 435 (H)

All prices exclude VAT.

SEE OFFERS & PRODUCTS ONLINE [enduramaxx.co.uk](http://enduramaxx.co.uk)

### Features

- Choose from a range of kits to adapt to ATVs, trailers, pick-ups and RTVs
- Controlled spraying
- Range of booms to suit your application
- Spare parts available for all sprayers and booms
- All models are fitted with a pressure regulator and gauge for accurate spray control
- Some assembly required



131018



131023



### 55-95L SPOT SPRAYERS

Code	Description	Dimensions in mm
131017	55L 12V Spot Sprayer 8.3L/min 60PSI Pump 4.5m Hose	865 (L) x 390 (W) x 345 (H)
131018	55L 12V Spot Sprayer 11.4L/min 60PSI Pump 4.5m Hose	865 (L) x 390 (W) x 345 (H)
131022	95L 12V Spot Sprayer 8.3L/min 60PSI Pump 4.5m Hose	865 (L) x 390 (W) x 480 (H)
131023	95L 12V Spot Sprayer 11.4L/min 60PSI Pump 4.5m Hose	865 (L) x 390 (W) x 480 (H)

### Features

- Choose from a range of kits to adapt to ATVs, trailers, pick-ups and RTVs
- Controlled spraying
- Range of booms to suit your application
- Spare parts available for all sprayers and booms
- All models are fitted with a pressure regulator and gauge for accurate spray control
- Some assembly required



131032



131026

### 150-225L SPOT SPRAYERS

Code	Description	Dimensions in mm
131025	150L 12V Spot Sprayer 8.3L/min 60PSI Pump 6m Hose	900 (L) x 620 (W) x 500 (H)
131026	150L 12V Spot Sprayer 11.4L/min 60PSI Pump 6m Hose	900 (L) x 620 (W) x 500 (H)
131030	225L 12V Spot Sprayer 8.3L/min 60PSI Pump 6m Hose	900 (L) x 620 (W) x 650 (H)
131032	225L 12V Spot Sprayer 11.4L/min 60PSI Pump 6m Hose	900 (L) x 620 (W) x 650 (H)





PRODUCTS SHOWN  
132122 225L Skid Unit & 151060SK 3m Boom Kit

**Features**

- Use for UTV spray systems
- Choose from 2 sizes of sprayer: 150 & 225L
- 6m of spray hose with metal spray gun
- Powder coated steel frame with hose wrap facility
- Easy to bolt together
- Add boom mount kit and boom as required



**SKID SPRAYERS**



Code	Description	Dimensions in mm
132115	150L Skid Unit c/w 8.3L/min Pump	1040 (L) x 650 (W) x 635 (H)
132116	150L Skid Unit c/w 11.4L/min Pump	1040 (L) x 650 (W) x 635 (H)
132122	225L Skid Unit c/w 8.3L/min Pump	1040 (L) x 650 (W) x 700 (H)
132123	225L Skid Unit c/w 11.4L/min Pump	1040 (L) x 650 (W) x 700 (H)

**OPTIONAL BOOM KITS**

Code	Description
151050SK	2m Boom Kit c/w UTV Kit
151060SK	3m Boom Kit c/w UTV Kit
151065SK	4m Boom Kit c/w UTV Kit
151104SK	4m Boomless Nozzle c/w UTV Kit

**HOSE REEL KITS** with mounting frame

Code	Description
136130	30m Hose Reel with <sup>3</sup> / <sub>8</sub> Hose + Fittings
136150	50m Hose Reel with <sup>3</sup> / <sub>8</sub> Hose + Fittings

More boom options on pages 23-27

**Features**

- Choose from 2 sizes of sprayer: 150 & 225L with 3.5HP Briggs and Stratton engine 28L/min @ 40PSI Delavan pump
- Heavy duty spray gun
- Adjustable pressure relief valve
- 6m hose



132422



**MOTORISED SKID SPRAYERS**

Code	Description	Dimensions in mm
132415	150L Skid Sprayer with 3.5HP Briggs and Stratton Engine	1300 (L) x 680 (W) x 550 (H)
132422	225L Skid Sprayer with 3.5HP Briggs and Stratton Engine	1300 (L) x 680 (W) x 700 (H)
151203-30	30m Hose Reel with Hose and Gun	
151205-50	50m Hose Reel with Hose and Gun	

**HIGH PERFORMANCE MOTORISED SKID SPRAYERS**



Code	Description	Dimensions in mm
132417	150L Skid Sprayer with Comet APS-41 Pump	1300 (L) x 680 (W) x 550 (H)
132424	225L Skid Sprayer with Comet APS-41 Pump	1300 (L) x 680 (W) x 700 (H)
151223-05-30	30m Hose & Reel with Hose and Gun	
151223-05-60	60m Hose Reel with Hose and Gun	

**Features**

- Great for tree spraying and orchard spraying
- Choose from 2 sizes of sprayer: 150L & 225L
- Comet APS-41 three diaphragm pump
- Honda GC160 engine
- Fitted with Deluxe spray gun
- Adjusts from stream to fog
- Fitted with 8m of 1/2" hose
- 38L/min @ 580PSI

132424







**Features**

- 2 sizes 150L and 225L – suitable for 3-point linkage spray systems
- Mounted on sturdy powder coated steel frame with hose wrap facility
- Choice of 12V pump with regulator for spray pressure control available
- 6m of hose & Powerjet spray gun for spot spraying applications
- Can be optioned with 2, 3 or 4m boom
- 2.4m of electrical cables with on/off switch & battery clips
- Easy to bolt together
- Ideal for small unit acre farms
- Add boom mount kit and boom as required – see pages 23-27

**3 POINT LINKAGE SPRAYERS**



Code	Description
133115	150L 3-Point Linkage Unit c/w 8.3L/min Pump
133117	150L 3-Point Linkage Unit c/w 11.4L/min Pump
133122	225L 3-Point Linkage Unit c/w 8.3L/min Pump
133123	225L 3-Point Linkage Unit c/w 11.4L/min Pump
136135	30m hose reel with 3/8 hose including mounting frame

**Features**

- 3 sizes: 200L, 300L and 400L
- Frames are hot dip galvanised
- 6m of hose & Powerjet spray gun
- 4.5m of electrical cables with on/off switch and battery clips/12V socket adaptor
- Boom options available – see pages 23-27



**PRO SERIES 12V SKID SPRAYERS**

Code	Description	Dimensions in mm
132020	200L Skid Sprayer Unit Fitted with 7.7L/min Delavan 60PSI 12V Pump	1100 (L) x 650 (W) x 650 (H) 255mm LID size
132030	300L Skid Sprayer Unit Fitted with 7.7L/min Delavan 60PSI 12V Pump	1000 (L) x 850 (W) x 740 (H) 255mm LID size
132045	400L Skid Sprayer Unit Fitted with 7.7L/min Delavan 60PSI 12V Pump	1400 (L) x 880 (W) x 735 (H) 255mm LID size

**PRO SERIES 12V SKID SPRAYERS WITH HOSE REEL**

Code	Description	Dimensions in mm
132025	200L Skid Sprayer Unit with 30m Hose Fitted with 11.4L/min Delavan 60PSI 12V Pump	1100 (L) x 650 (W) x 945 (H) 255mm LID size
132035	300L Skid Sprayer Unit with 30m Hose Fitted with 11.4L/min Delavan 60PSI 12V Pump	1000 (L) x 850 (W) x 1035 (H) 255mm LID size
132040	400L Skid Sprayer Unit with 30m Hose Fitted with 11.4L/min Delavan 60PSI 12V Pump	1100 (L) x 880 (W) x 1030 (H) 255mm LID size



## PRO SERIES MOTORISED SKID SPRAYERS

Code	Description	Dimensions in mm
132820	200L Sprayer with Spray Marshal Pump Kit	1100 (L) x 650 (W) x 1030 (H)
132830	300L Sprayer with Spray Marshal Pump Kit	1000 (L) x 850 (W) x 1120 (H)
132840	400L Sprayer with Spray Marshal Pump Kit	1400 (L) x 880 (W) x 1115 (H)

## Features

- Genuine Honda GX35 4 stroke motor for proven reliability - 3 year warranty
- Glycerin filled pressure gauge
- Spray gun has adjustable turbo atomiser for full range of spray requirements
- Hot dipped galvanised frame
- Secure tank mounting system
- 30m hose & reel ready to use versatility



132820



Rapid Commando™ pump  
- stainless steel & brass  
construction with Viton  
seals. Pumps at 12L/min  
and up to 360PSI - ideal  
for spot spraying or small  
boom spraying

## Other pump options available (price on application):

Delavan Roller Pump 28L/min @ 40PSI / Briggs & Stratton Engine  
Comet Pump 22L/min @ 290PSI / Honda GX120 Engine  
Comet Pump 38L/min @ 580PSI / Honda GX120 Engine  
Comet Pump 50L/min @ 580PSI / Honda GX240 Engine  
Comet Pump 67L/min @ 580PSI / Honda GX390 Engine

## Features

- Excellent chemical resistance characteristics
- Rapid Commando™ pump constructed from stainless steel & brass - fitted with Viton seals, pressure regulator & gauge
- Rapid Commando™ 12L/min pump 25 Bar (360PSI) & pressure regulator & gauge
- Compact space saving design
- Spray gun has adjustable turbo atomiser for full range of spray requirements
- 30m hose & reel hose swivel prevents hose tangles



132224



132240



## 200L SPRAY UNIT



Code	Description	Dimensions in mm
132224	240L Spray Unit - 12L/min Pump 25 Bar (360PSI) & 30m Hose	925 (L) x 710 (W) x 510 (H)
132240	400L Spray Unit - 12L/min Pump 25 Bar (360PSI) & 30m Hose	1600 (L) x 710 (W) x 510 (H)



### Features

- UV stabilised & chemical resistant polyethylene tank specifically designed for spraying
- Available in 500L and 700L sizes
- Sump in tank for maximum use of contents and easy cleaning
- Graduations for easy measurement of contents
- Choice of reliable, high performance Comet & Bertolini diaphragm pumps
- Spray gun
- Hot dip galvanised steel frame
- Suction filter
- Genuine Honda engine with 3 year warranty



132870

**FIELD  
SPRAYER**

### FIELD SPRAY UNITS

Code	Description	Dimensions in mm
132850	500L Spray Marshal Skid Unit	1680 (L) x 1170 (W) x 685 (H)
132870	700L Spray Marshal Skid Unit	1680 (L) x 1170 (W) x 685 (H)

#### Other pump options available (price on application):

Delavan Roller Pump 28L/min @ 40PSI / Briggs & Stratton Engine  
 Comet Pump 22L/min @ 290PSI / Honda GX120 Engine  
 Comet Pump 38L/min @ 580PSI / Honda GX120 Engine  
 Comet Pump 50L/min @ 580PSI / Honda GX240 Engine  
 Comet Pump 67L/min @ 580PSI / Honda GX390 Engine

30m, 60m and  
90m hose reels  
are available (price  
on application)

### Features

- Units supplied with 10m of high pressure hose and lance
- Available in 500L and 700L sizes



1325701



### 500L & 700L PRESSURE WASHER SKID UNITS

Code	Description
1325501	500L 12L/min @ 1960PSI / Honda GX160 Engine
1325701	700L 12L/min @ 1960PSI / Honda GX160 Engine
1325502	500L 15L/min @ 2800PSI / Honda GX340 Engine
1325702	700L 15L/min @ 2800PSI / Honda GX340 Engine
1325503	500L 21L/min @ 2380PSI / Honda GX390 Engine
1325703	700L 21L/min @ 2380PSI / Honda GX390 Engine
1325504	500L 23L/min @ 3500PSI / Briggs & Stratton Engine - Electric start
1325704	700L 23L/min @ 3500PSI / Briggs & Stratton Engine - Electric start
1325505	500L 15L/min @ 2800PSI / Hatz IP40 Diesel Engine - Electric start
1325705	700L 15L/min @ 2800PSI / Hatz IP40 Diesel Engine - Electric start

# 18 DUST SUPPRESSION & PLANT WATERING

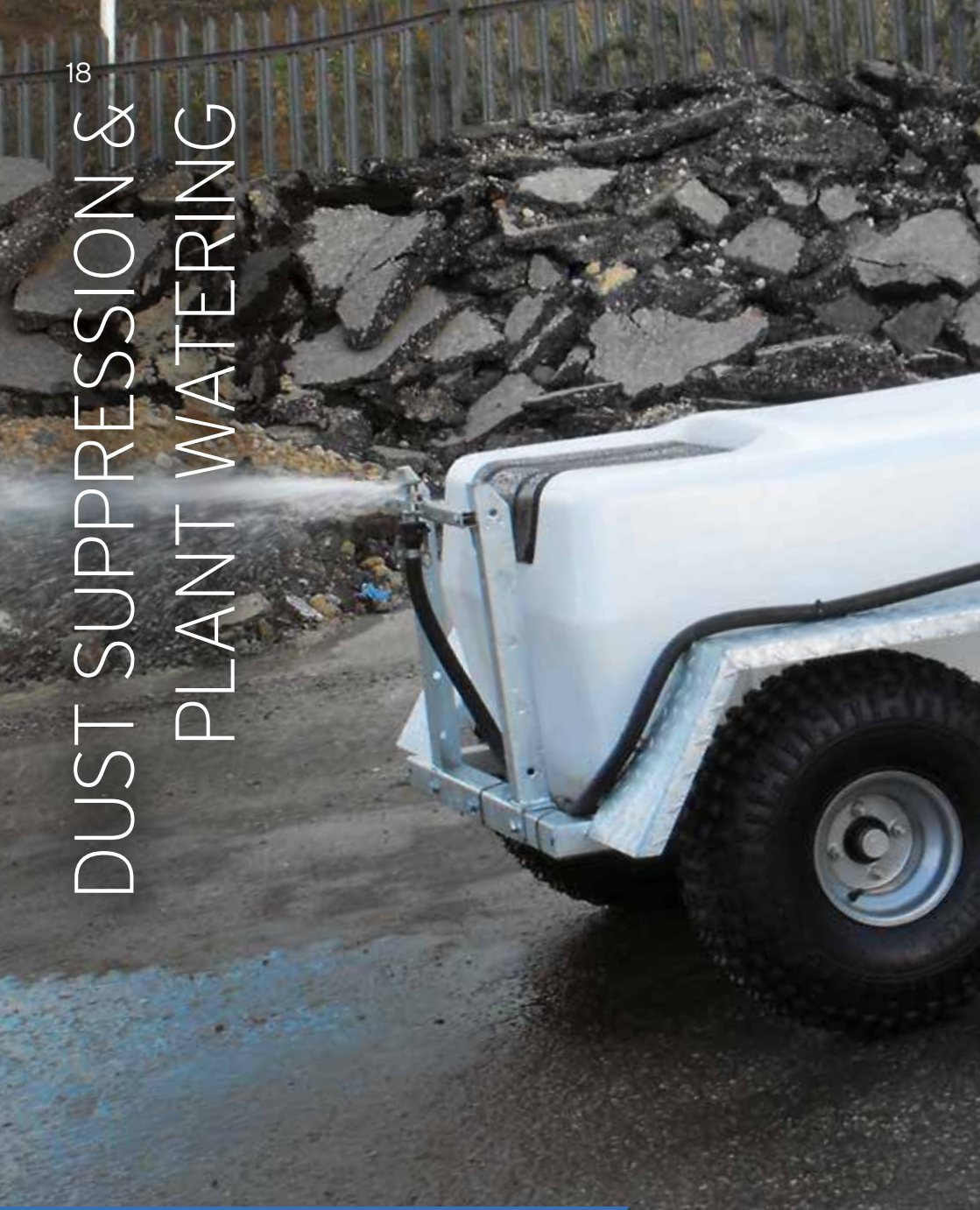

PRODUCT SHOWN  
1415402 400L Trailer Dust Suppression Unit

## 200L - 5000L SKID WATERING UNITS



1326402



### 200L - 5000L SKID WATERING UNITS

Code	Description
1326201	200L 38L/min 12V Pump, 6m x 1/2" Hose, Watering Lance
1326202	200L Honda 1" Pump, 30m x 3/4" Hose (no Reel), Watering Lance
1326301	300L 38L/min 12V Pump, 6m x 1/2" Hose, Watering Lance
1326302	300L Honda 1" Pump, 30m x 3/4" Hose (with Hose Reel), Watering Lance
1326401	400L 38L/min 12V Pump, 6m x 1/2" Hose, Watering Lance
1326402	400L Honda 1" Pump, 30m x 3/4" Hose (no Reel), Watering Lance
1326403	400L Honda 1" Pump, 30m x 3/4" Hose (with Hose Reel), Watering Lance
1326501	500L 38L/min 12V Pump, 6m x 1/2" Hose, Watering Lance
1326502	500L Honda 1" Pump, 30m x 3/4" Hose (no Reel), Watering Lance
1326503	500L Honda 1" Pump, 30m x 3/4" Hose (with Hose Reel), Watering Lance
1326701	700L 38L/min 12V Pump, 6m x 1/2" Hose, Watering Wance
1326702	700L Honda 1" Pump, 30m x 3/4" Hose (no Reel), Watering Lance
1326703	700L Honda 1" Pump, 30m x 3/4" Hose (with Hose Reel), Watering Lance

Other tanks sizes available include:

1200L, 1500L, 2000L, 3000L, 4000L & 5000L (Price on application)

All prices exclude VAT.

SEE OFFERS & PRODUCTS ONLINE [enduramaxx.co.uk](http://enduramaxx.co.uk)





**Features**

- Choice of 2 tank sizes available
- Galvanised frames
- Reliable Honda pumps



**200L & 400L TRAILER WATERING UNITS**

Code	Description
141421	200L 38L/min 12V Pump, 6m x 1/2" Hose, Watering Lance
141422	200L Honda 1" Pump, 30m x 3/4" Hose (no Reel), Watering Lance
141441	400L 38L/min 12V Pump, 6m x 1/2" Hose, Watering Lance
141442	400L Honda 1" Pump, 30m x 3/4" Hose (no Reel), Watering Lance
141443	400L Honda 1" Pump, 30m x 3/4" Hose (with Hose Reel), Watering Lance

**Features**

- Galvanised frames
- Reliable Honda pumps



1327702

**200L - 5000L DUST SUPPRESSION SKID UNITS**

Code	Description
1327201	200L Honda 1" Pump, 25m x 3/4" Hose (no Reel), 3/4" Deflector Nozzle
1327301	300L Honda 1" Pump, 25m x 3/4" Hose (no Reel), 3/4" Deflector Nozzle
1327401	400L Honda 1" Pump, 25m x 3/4" Hose (no Reel), 3/4" Deflector Nozzle
1327402	400L Honda 1" Pump, 25m x 3/4" Hose (with Reel), 3/4" Deflector Nozzle
1327501	500L Honda 1" Pump, 25m x 3/4" Hose (no Reel), 3/4" Deflector Nozzle
1327502	500L Honda 1" Pump, 25m x 3/4" Hose (with Reel), 3/4" Deflector Nozzle
1327701	700L Honda 1" Pump, 25m x 3/4" Hose (no Reel), 3/4" Deflector Nozzle
1327702	700L Honda 1" Pump, 25m x 3/4" Hose (with Reel), 3/4" Deflector Nozzle

**Other tanks sizes available include:**

1200L, 1500L, 2000L, 3000L, 4000L & 5000L (Price on application)





**Features**

- Choice of 2 tank sizes available
- Galvanised frames
- Reliable Honda pumps



1415402

**200L & 400L TRAILER DUST SUPPRESSION UNITS**

Code	Description
1415201	200L Honda 1" Pump, 25m x 3/4" Hose (no Reel), 3/4" Deflector Nozzle
1415401	400L Honda 1" Pump, 25m x 3/4" Hose (no Reel), 3/4" Deflector Nozzle
1415402	400L Honda 1" Pump, 25m x 3/4" Hose (with Reel), 3/4" Deflector Nozzle



PRODUCT SHOWN  
141315 150L Trailer Unit & 151060 3m Boom Kit





**DEFLECTOR 140° NOZZLE SPRAY BOOM**

Code	Description
151050	2m Boom
151060	3m Folding Boom
1510605	4m Folding Boom
151050ATV	2m Boom with ATV Mounting Kit
151060ATV	3m Folding Boom with ATV Mounting Kit
151065ATV	4m Folding Boom with ATV Mounting Kit

**Features**

- 3 sizes: 2m, 3m and 4m
- Fitted with deflector 140 spray nozzles at 1000mm spacings
- 3m and 4m booms have spring loaded positive action breakaway and vertical fold capacity
- On/off taps fitted as standard on 3m and 4m folding booms
- Kits come with hose and fittings
- Some assembly required



**FLAT FAN 110° NOZZLE SPRAY BOOM**

Code	Description
152060	2.5m Folding Boom
152065	3.5m Folding Boom
152060ATV	2.5m Folding Boom with ATV Mounting Kit
152065ATV	3.5m Folding Boom with ATV Mounting Kit

**Features**

- 2 sizes: 2.5m and 3.5m
- Fitted with flat fan type spray nozzles at 500mm spacing with anti-drip diaphragm
- Spring loaded positive action breakaway and vertical fold capacity
- Kits come with on/off valve, hose and fittings
- Some assembly required



**BOOMLESS NOZZLE KITS**

Code	Description	Coverage
151102	Up to 37L/hectare Minimum Pump Capacity 7L/min	2m
151104	Up to 37L/hectare Minimum Pump Capacity 7L/min	4m
151107 #2 nozzle	Up to 37L/hectare Minimum Pump Capacity 7L/min	7m
151115 #5 nozzle	Up to 74L/hectare Minimum Pump Capacity 11L/min	15m
151116 #10 nozzle	Up to 147L/hectare Minimum Pump Capacity 20L/min	16m
151117 #20 nozzle	Up to 190L/hectare Minimum Pump Capacity 30L/min	17m



**Features**

- 6 sizes to choose from
- Use with ATV, 3PL or ute sprayers
- Can be used as 180° swath or 90° swath by swapping nozzle plates
- Ideal for rough country spraying
- Brass boomless nozzle
- Steel mounting brackets
- On/off tap with 1/4" male BSP fitting
- Can be easily changed from one side to two side spraying 7-17m sizes



**Features**

- 1.2m compact boom
- Sprays 5m swath width
- Compatible with any spot sprayer with pump - 6.8L/min or more
- Versatility of spraying options
- Fitted with diaphragm check valve & ball check filters



151015

**VERSATILE BOOM**

Code	Description
151015	Versatile Boom



**Features**

- Boom mounting brackets with U bolt clamps for attaching to vehicle/trailer
- 110° Low drift nozzles x3
- Metal boom guards for protection of end nozzles
- On/off ball valve tap for OC end jet nozzles
- Fitted with diaphragm check valve & ball check filters



136505



**BUDGET/VERSATILE BOOM MOUNTING KIT**

Code	Description
136505	Budget/Versatile Boom Mounting Kit

**Features**

- Mounts directly to ATV front or rear rack
- Height adjustable
- Suitable for smaller spraying jobs
- Pump delivery of 3.8L/min sufficient for efficient coverage
- Fitted with diaphragm check valve & ball check filters
- 1.5m spray width

**BUDGET BOOM**

Code	Description
151012	Budget Boom



151012



SUITABLE FOR  
SMALLER  
SPRAYING  
JOBS

PRODUCT SHOWN  
151015 Versatile Boom





PRODUCTS SHOWN  
141312 95L 12V Estate Sprayer  
& 151060 3m Boom

## SILVER SERIES 12V TRAILER SPRAYERS

### Features

- 2 sizes 55L and 95L
- Mounted on sturdy powder coated steel frame
- Reliable 8.3L/min pump with regulator and gauge for spray pressure control
- 4.5m of hose & spray gun for spot spraying applications
- Options include 2, 3 or 4m booms see pages 23-27
- 2.4m of electrical cables with on/off switch & battery clips
- 10" x 4" - 4", 2 ply pneumatic tyres
- Clevis hitch to attach to lawn tractor



### 12V ESTATE SPRAYERS

Code	Description
141307	55L 12V Estate Sprayer 8.3L/min 60PSI Pump
141312	95L 12V Estate Sprayer 8.3L/min 60PSI Pump

### SILVER SERIES BOOM KIT OPTIONS

Code	Description
151050	2m Boom Kit
151060	3m Boom Kit
151065	4m Boom Kit
151104	4m Boomless Nozzle Kit

More boom options on pages 23-27





**CHOOSE FROM 2 PUMP OPTIONS 12V OR 3.5HP**



143422

Silver Series

**ATV MOTORISED TRAILER SPRAYER**

Code	Description
141315	150L 12V Estate Sprayer
141322	225L 12V Estate Sprayer
143415	150L Estate Sprayer with 3.5HP Briggs and Stratton Engine
143422	225L Estate Sprayer with 3.5HP Briggs and Stratton Engine

**Features**

- 2 sizes 150L & 225L - suitable for ATVs and large mowers
- Mounted on sturdy powder coated steel frame
- Reliable 8.3L/min pump with regulator for spray pressure control
- 4.5m of hose & Powerjet spray gun for spot spraying applications
- Options include 2, 3 or 4m booms
- 2.4m of electrical cables with on/off switch & battery clips
- 18" x 7" - 8", 4 ply pneumatic tyres
- Choose from 2 pump options; 12V 8.3L/min 60PSI pump or 3.5HP 34L/min 40PSI pump

**BOOM KIT OPTIONS**

Code	Description
151050	2m Boom Kit
151060	3m Boom Kit
151065	4m Boom Kit

More boom options on pages 23-27

**Features**

- Pressure regulator with gauge for accurate & controlled spraying
- 7.7L/min, 400kPa (60PSI) Delavan pump mounted under cover
- 6m of 10mm spray hose
- Boom mounting brackets
- Single axle fitted with 22" high flotation all terrain tyres
- Hose wrap for storage & spray lance holder
- Chequer plate mudguards
- Strong steel construction chassis, hot dip galvanised for durability
- 50mm tow hitch
- Choose from a 11.4L/min, 15.2L/min, 19L/min or 26L/min pump



141020

SPRAY RANGER

**200L ATV TRAILER SPRAYER**

Code	Description	Pump
141020	200L ATV Trailer - Single Axle	7.7L/min 12V
141021	200L ATV Trailer - Single Axle	11.4L/min 12V
141120	200L ATV Trailer - Single Axle	12L/min Rapid Commando Motorised

**ADD ON OPTIONS**

Code	Description
151015	Versatile Boom
1364030	30m Hose Reel c/w 30m Hose and Hand Gun including Mounting Frame
1364060	60m Hose Reel c/w 60m Hose and Hand Gun including Mounting Frame

More boom options on pages 23-27



141120



**Features**

- Range of motorised and 12V pumps available. See page 16 for motorised pump options and pages 40-45 for 12V options
- Hinged drawbar allows flotation over uneven terrain
- Dual axles fitted with 22" high flotation all terrain tyres
- Hot dip galvanised steel frame



141040



**400L ATV TRAILER SPRAYER**

Code	Description	Pump
141040	400L Trailer - Double Axle	7.7L/min 12V
141042	400L Trailer - Double Axle	11.4L/min 12V
141140	400L Trailer - Double Axle	12L/min Rapid Commando Motorised

**ADD ON OPTIONS**

Code	Description
151015	Versatile Boom
151203-30	30m Hose Reel c/w 30m Hose and Hand Gun inc. Mounting Frame
151205-50	50m Hose reel c/w 50m Hose and Hand Gun inc. Mounting Frame

More boom options on pages 23-27



**Features**

- 200 or 400L capacity
- Comes with 2m of 1.5" hose and quarter turn tap
- Fitted with off road tyres



142020



142040

**WATER BOWSERS**

Code	Description
142020	200L Water Bowser - Single Axle
142040	400L Water Bowser - Double Axle



PRODUCTS SHOWN  
131004 34L Push Along Sprayer

## 16L KNAPSACK SPRAYER

**Features**

- Built-in carry handle for easy transport
- Wide-mouthed tank lid opening for less spillage
- Lance clips to side of tank for convenient storage
- Lever action piston pump with convertible handle for right or left hand use
- Built-in strainers and filters to help prevent clogging
- Ergonomically designed tank comes with quick fitting padded shoulder harness

**16L KNAPSACK SPRAYER**

Code	Description
121215	16L Knapsack Sprayer
121145	Spares Kit

COMES WITH  
**4 SPRAY TIPS**

**COMES WITH 4 SPRAY TIPS**

The Enduramaxx Knapsack Sprayer features four spray tips. Choose between:



Flat Fan Spray



Conical Spray Tip

4-Hole Adjustable  
Spray TipDual Conical  
Spray Tip



## 34L PUSH ALONG SPRAYER

## Features

- Reliable 3.8L/min 40PSI pump
- Spray lance with adjustable nozzle for range of spraying options
- Lance clips hold spray lance securely
- Boomless nozzle sprays up to 1m width for spraying large areas of lawn
- Easily adjustable handle suits all users - max. height 1070mm
- Large wheels & tyres - 300mm diameter easily handle steps and uneven terrain
- Well balanced and easy to use
- Tow bar supplied for easy hitching to ride on mowers
- Electric on/off switch for pump
- Drain bung for easy cleaning
- Rechargeable 12V battery (charger included)
- Overall width 605mm



## 34L PUSH ALONG SPRAYER

Code	Description
131004	Pull Along Sprayer 3.8L/min 40PSI Pump



PRODUCT SHOWN  
131015 55L Spot Sprayer



**SPRAY LANCES**

Code	Description
135010	Economy Spray Lance
135015	Economy Telescopic Spray Lance

**Features**

- Lightweight chromed aluminium economy spray lance
- Adjustable spray nozzle
- Filter in handle
- 10mm hose barb connection
- 750mm overall length for standard lance
- 1500m maximum length for telescopic lance

**TOP GUN**

Code	Description
135024	Top Gun



**Features**

- High pressure, long range, multi-purpose spray gun
- Front handgrip allows quick spray pattern selection
- Fitted with trigger lock and 1/2" swivel inlet
- Overall length: 700mm
- Max range: 25m @ 50bar
- Max pressure: 60 Bar (870PSI)
- Max flow rate: 135L/min

**MULTI-PURPOSE SPRAY GUN**

Code	Description
135022	Multi-purpose Spray Gun



**Features**

- Great value multi-purpose spray gun
- One hand operation for easy pattern adjustment and on/off trigger
- Adjustable turbo atomiser
- Supplied with 10mm hose tail
- Max pressure 250PSI
- Overall length 445mm

**SWIVEL CONNECTOR**

Code	Description
1232038	Swivel Connector



**Features**

- No more tangled hoses!
- Max pressure: 50 Bar (725PSI)
- 3/8" female threads

**POWERJET SPRAY GUN**

Code	Description
135020	700mm Powerjet Spray Gun - 700mm long
135018	250mm Powerjet Spray Gun - 250mm long



**135020 Features**

- Standard equipment on our professional sprayers
- Durable, dependable spray gun used for high pressure washing, cleaning and agricultural applications
- Adjustable nozzle
- Overall length: 700mm
- Max pressure: 190 Bar (2950PSI)
- Now fitted with hose swivel

**135018 Features**

- Same as STAL 26 with no extension
- Overall length: 250mm
- Fitted with hose swivel

**PISTOL GRIP SPRAY GUN**

Code	Description
135017	Pistol Grip Spray Gun







## 134012

- 3.8L/min open flow 270kPa (40PSI) demand switch
- Santoprene diaphragm
- Self priming up to 1.2m
- 2 chamber positive displacement diaphragm pump, capable of being run dry
- Viton valves
- 3/8" hose barb inlet/outlet part

PSI	Bar	L/min	Amps
0-3	0.2	3.7	1.4
10	0.7	3	1.7
20	1.4	2.2	2.0
30	2.1	1.7	2.1
40	2.8	1.4	2.2



## 134022

- 8.3L/min open flow 400kPa (60PSI) demand switch
- Viton valves, Santoprene diaphragm
- Self priming up to 4m
- 3 chamber positive displacement diaphragm pump capable of being run dry
- Supplied with 2 pin electrical connector

PSI	L/min	Amps
0-3	8.3	4.0
10	7.5	4.5
20	6.9	5.1
30	6.3	5.6
40	5.9	6.2
50	5.6	6.8
60	5.5	7.4



## 134032

- 11.4L/min open flow 400kPa (60PSI) demand switch
- Viton valves, Santoprene diaphragm
- Self priming up to 4m
- Supplied with 2 pin electrical connector
- 5 chamber positive displacement pump capable of being run dry

PSI	L/min	Amps
0-3	12	4.2
10	10.9	5.5
20	9.6	6.7
30	8.5	7.8
40	7.5	8.6
50	6.2	9.1



## 134034

- 15.2L/min open flow 400kPa (60PSI) demand switch
- Other specs same as 11.4L/min pumps

PSI	L/min	Amps
0-3	17	6.4
10	16	7.5
20	15.1	9.0
30	14	10.4
40	12.4	11.7
50	11.1	12.7



## 134035

- 19L/min open flow 270kPa (45PSI) demand switch
- Other specs same as 11.4L/min pumps

PSI	L/min	Amps
0-3	21.7	8.4
10	19.8	10.3
20	17.6	12.1
30	15.6	14.2
40	14	16.0
50	12.9	17.3



## 134010

- 3.8L/min open flow 270kPa (40PSI) demand switch
- Santoprene diaphragm
- Self priming up to 1.2m
- 2 chamber positive displacement diaphragm pump, capable of being run dry
- Viton valves
- 3/8" hose barb inlet/outlet part

PSI	Bar	L/min	Amps
0-3	0.2	3.7	1.5
10	0.7	3.2	1.9
20	1.4	2.7	2.1
30	2.1	2.3	2.4
40	2.8	1.5	2.6



## 134020

- 7.7L/min open flow 400kPa (60PSI) demand switch
- Viton valves, Santoprene diaphragm
- Self priming up to 4m
- 3 chamber positive displacement diaphragm pump capable of being run dry
- Supplied with 2 pin electrical connector

PSI	L/min	Amps
10	7.6	2.8
20	6.4	3.7
30	6.0	4.2
40	5.8	4.7
50	4.7	5.2
60	4.0	5.7



## 134030

- 11.4L/min open flow 400kPa (60PSI) demand switch
- Viton valves, Santoprene diaphragm
- Self priming up to 4m
- Supplied with 2 pin electrical connector
- 5 chamber positive displacement pump capable of being run dry

PSI	L/min	Amps
10	21.1	3.5
20	10.6	5.8
30	10.0	7.2
40	9.3	8.3
50	8.3	9.1
60	7.6	9.9

**134037**

- 15.2L/min open flow 400kPa (60PSI) demand switch
- Viton valves, Santoprene diaphragm
- Self priming up to 4m
- Supplied with 2 pin electrical connector
- 5 chamber positive displacement pump capable of being run dry

PSI	L/min	Amps
10	15.2	4.8
20	14.0	6.1
30	11.7	7.7
40	10.2	9.6
50	9.5	10.0
60	9.1	10.8

**134040**

- 19L/min open flow 270kPa (45PSI) demand switch
- Viton valves, Santoprene diaphragm
- Self priming up to 4m
- Supplied with 2 pin electrical connector
- 5 chamber positive displacement pump capable of being run dry

PSI	L/min	Amps
10	19.0	6.0
20	17.1	9.0
30	15.5	10.0
40	14.4	1.01

**134050**

- 26L/min open flow 400kPa (60PSI) demand switch
- Viton valves, Santoprene diaphragm
- Self priming up to 4m
- 3 chamber positive displacement diaphragm pump capable of being run dry
- Supplied with 2 pin electrical connector

PSI	L/min	Amps
10	26.4	11
20	25.7	12
40	22.5	13
60	18.8	17
80	14.9	21
100	9.6	25

**134002**

- 3.8L/min open flow 270kPa (40PSI) demand switch
- Viton valves with Santoprene diaphragm
- $\frac{3}{8}$ " male hose barbs

**134004**

- 6.8L/min open flow 400kPa (60PSI) demand switch
- Viton valves with Santoprene diaphragm
- $\frac{3}{8}$ " female hose barbs

**134006**

- 11.4L/min open flow 400kPa (60PSI) demand switch
- Viton valves with Santoprene diaphragm
- $\frac{3}{8}$ " female hose barbs





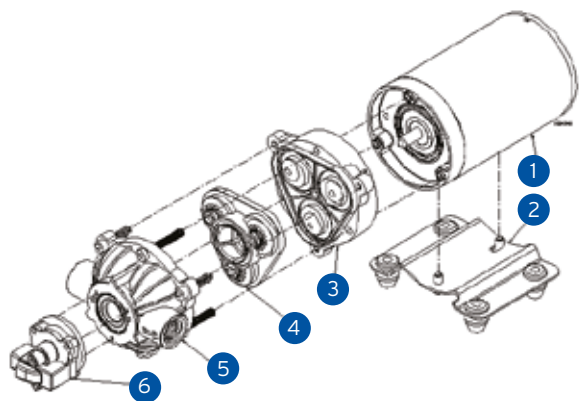

DELAVAN PUMP PARTS

Code	Description	
139030	Lower Housing Assembly - for 7.7L/min Pumps - Diaphragm	4
139032	Lower Housing Assembly - for 11.4L/min Pumps - Diaphragm	4
139034	Lower Housing Assembly - for 19L/min Pumps - Diaphragm	4
139020	Valve Housing Assembly for 7800 pumps	3
139022	Valve Housing Assembly for 5900 pumps	3
139010	Upper Housing Assembly for 7800 pumps	2
139012	Upper Housing Assembly for 5900 pumps	2
139050	Pressure Switch Only to Suit 7800 Series Pumps	1
139051	Pressure Switch Only to Suit 5900 Series Pumps	1

EVERFLO PUMP PARTS

Code	Description	
139120	Motor Everflo 8.3L/min	1
139122	Motor Everflo 11.4/15 & 19L/min	1
139130	Base Plate Assembly	2
139140	Diaphragm Assembly - Everflo 8.3L/min	3
139142	Diaphragm Assembly - Everflo 11.4L/min	3
139144	Diaphragm Assembly - Everflo 15L/min	3
139146	Diaphragm Assembly - Everflo 19L/min	3
139110	Valve Plate Assembly - Everflo 8.3L/min	4
139112	Valve Plate Assembly - Everflo 11.4/15 & 19L/min	4
139150	Pump Head Assembly - Everflo 8.3L/min	5
139152	Pump Head Assembly - Everflo 11.4/15 & 19L/min	5
139052	Pressure Switch Assembly - Everflo 8.3L/min	6
139053	Pressure Switch Assembly - Everflo 11.4/15 & 19L/min	6



## PRESSURE REGULATORS

Code	Description
134062	Regulator for 7.7L/min Pump (Quick Attach)
134062-ST	Regulator for 7.7L/min Pump (Screw Type)
134066	Regulator for 11.4/15 & 19L/min Pump (Quick Attach)
134066-ST	Regulator for 11.4/15 & 19L/min Pump (Screw Type)



## PRESSURE GAUGES

Code	Description
134085	100PSI - 1/4" M Bottom Thread
134530	100PSI - 1/8" M Back Thread



## HOSE CONNECTORS

Code	Description
137050-PK	3/8" M x 3/8" Hose Barb - Polypropylene Pack of 10
137052-PK	1/2" M x 3/8" Hose Barb - Polypropylene Pack of 10
137057-PK	1/2" M x 1/2" Hose Barb - Polypropylene Pack of 10



## WIRING HARNESS

Code	Description
135085	Silver Series Wiring Harness
135087	Complete Professional Series Wiring Harness



## FILTERS

Code	Description
134063	Filter for 7.7L/min Pump (Quick Attach)
134063-ST	Filter for 7.7L/min Pump (Screw Type)
134067	Filter for 11.4/15 & 19L/min Pump (Quick Attach)
134068-ST	Filter for 11.4/15 & 19L/min Pump (Screw Type)



## SCREW ATTACH HOSE BARBS

Code	Description
137058	1/2" M x 3/8" HB Straight - Polypropylene
137050	3/8" M x 3/8" HB Straight - Polypropylene
137052	1/2" M x 3/8" HB Straight - Polypropylene
137057	1/2" M x 1/2" HB Straight - Polypropylene
137079-M-PP	3/4" M x 1/2" HB Straight - Polypropylene
137083-PP	3/4" M x 3/4" HB Straight - Polypropylene
137061	1/4" M x 3/8" HB Elbow - Polypropylene
137064	3/8" M x 3/8" HB Elbow - Polypropylene
137065	1/2" M x 3/8" HB Elbow - Polypropylene
137065-075	1/2" M x 1/2" HB Elbow - Polypropylene
137073	3/4" M x 1/2" HB Elbow - Polypropylene
137074	3/4" M x 3/4" HB Elbow - Polypropylene













## QUICK ATTACH HOSE BARBS

Code	Description
134070-PK	10mm Hose Barb Elbow (2 pack)
134072-PK	13mm Hose Barb Elbow (2 pack)
134074-PK	10mm Hose Barb Straight (2 pack)
134076-PK	13mm Hose Barb Straight (2 pack)





FLAT FAN NOZZLES

Colour	Code	Description	Pack Qty
	123036-PK	001 Flat Fan 110° Nozzle	10
	123038-PK	0015 Flat Fan 110° Nozzle	10
	123040-PK	002 Flat Fan 110° Nozzle	10
	134042-PK	0025 Flat Fan 110° Nozzle	10
	123044-PK	003 Flat Fan 110° Nozzle	10
	123046-PK	004 Flat Fan 110° Nozzle	10
	123048-PK	005 Flat Fan 110° Nozzle	10
	123050-PK	006 Flat Fan 110° Nozzle	10
	123052-PK	008 Flat Fan 110° Nozzle	10
	123054-PK	0010 Flat Fan 110° Nozzle	10

Features







- Precision moulded in polyacetal, a highly stable polymeric material with outstanding wear characteristics
- Colour coded (in accordance with ISO10625) for quick identification of flow rate

Applications

- Used for broadcast application of pre and post emergent herbicides, fungicides and insecticides



DEFLECTOR 140° NOZZLES

Colour	Code	Description	Pack Qty
	1230005-PK	0.5 Deflector 140° Nozzle	10
	123001-PK	1.0 Deflector 140° Nozzle	10
	123002-PK	1.5 Deflector 140° Nozzle	10
	123004-PK	2.0 Deflector 140° Nozzle	10
	123006-PK	2.5 Deflector 140° Nozzle	10
	123008-PK	3.0 Deflector 140° Nozzle	10
	123010-PK	4.0 Deflector 140° Nozzle	10

Applications

- Well suited to broadcast spraying with small boom sprayers fitted to all-terrain vehicles. The wide angle allows the nozzles to be spaced at 1m intervals effectively reducing the number of nozzles required
- This wide angle Deflector is also suitable for use with knapsack sprayers for single nozzle applications where the wide swath will improve productivity
- The Deflector 140° is very good for pre-emergent and soil incorporated herbicides and good for post emergent herbicides
- Good for systemic formulations of insecticides and fungicides

Features



- Wide spray angle of 140°
- Gives a narrow rectangular spray pattern
- Reduced potential clogging due to large round orifice
- Produces coarse droplets with reduced potential drift when operated at 1 + 2 bar
- Incorporates screwdriver slot at the front to enable nozzle to be aligned in standard caps
- Moulded in high performance colour coded (non ISO) polyacetal providing good wear and chemical compatibility



QUICK FITTING CAP





**FILTERS**

Colour	Code	Description	Pack Qty
	126026	Ball Check Filter (50 Mesh)	10
	126027	Ball Check Filter (50 Mesh)	10



**NOZZLE CAPS**

Colour	Code	Description	Pack Qty
	126028-PK	Nozzle Cap c/w Gasket	4
	126030-PK	Nozzle Cap c/w Gasket	4
	126031-PK	Nozzle Cap c/w Gasket	4



**NOZZLE BODIES**

Code	Description	Pack Qty
126055-PK	Wet Boom Clamp Type Non-drip Nozzle Holder with Seal, Bolts & Cap-suit 1/2" Pipe	4
126022-PK	Tee Non-drip Dry Boom Nozzle Holder with Cap - 3/8" Hose Barbs	4
126020-PK	Elbow Non-drip Dry Boom Nozzle Holder with Cap - 3/8" Hose Barbs	4
126023-PK	Cross' Non-drip Dry Boom Nozzle Holder - 3/8" Hose Barbs	4



**Dry Boom Features**

- Polypropylene construction complete with quick couple cap and gasket
- EPDM diaphragm check valve opens at 0.5 Bar
- Max working pressure 20bar
- 10mm (3/8") hose barbs - single, two or three

**Wet Boom Features**

- Designed for clamping around 1/2" spray tubes
- 10mm inlet size - polypropylene construction complete with quick couple cap, gasket, seal and screws
- EPDM diaphragm check valve opens at 0.5 Bar

**PAGE**

**PAGE**

3-Point Linkage Sprayers	12	Knapsack Sprayer	35
12V & Motorised Pro Series Trailer Sprayers	31-32	Motorised Silver Series Trailer Sprayers	30
12V Pro Series Skid Sprayer	13	Plant Watering Skid & Trailer Units	19-20
12V Pumps	40-43	Pro Series Motorised Skid Sprayers	14-15
12V Pump Spares	44-47	Push-Along Sprayer	36
12V Silver Series Skid Sprayers	9	Silver Series Motorised Skid Sprayers	10-11
12V Silver Series Trailer Sprayers	29	Spray Booms	24-27
500L & 700L Field Spray Units	16	Spray Lances	38-39
500L & 700L Pressure Washer Skid Units	17	Sprayer & Boom Spares	48-50
ATV Spot Sprayers	5-7	Water Bowsers	33
Dust Suppression Skid & Trailer Units	21-22		

We are proud that all our products are safe and environmentally friendly.







To fulfil our customers' needs we develop and manufacture innovative sprayer products along with ultimate customer care. Together we strive for a culture where perfection is only just good enough.

### **The Enduramaxx Team**

Our products are available from many stores - for your nearest Enduramaxx dealer call us on 0800 840 4030 or visit [enduramaxx.co.uk](http://enduramaxx.co.uk)

**Telephone** 01778 562 810

**Freephone** 0800 840 4030

**Fax** 01778 560 488

**Email** [sales@enduramaxx.co.uk](mailto:sales@enduramaxx.co.uk)

**Web** [enduramaxx.co.uk](http://enduramaxx.co.uk)

**Address** Outgang Road, Baston Fen,  
Baston PE6 9PT

### **Global Associates**

While Enduramaxx is a British company we have global reach with products being sold in Argentina, Australia, France and the United States of America

**Argentina** [duraplas-argentina.com](http://duraplas-argentina.com)

**Australia** [rapidspray.net](http://rapidspray.net)

**France** [duraplas.net](http://duraplas.net)

**USA** [agrimaxx.com](http://agrimaxx.com)

**UK** [enduramaxx.co.uk](http://enduramaxx.co.uk)



VAT number 910 1496 55

Certificate number 10720  
ISO 9001: 2008