



# Mass Spectrometers for Gas Analysis Applications

## MASS SPECTROMETERS

# QIC Series and HPR Series Systems for Gas Analysis Applications

A range of gas analysis systems: stable, sensitive and responsive for real-time analysis of multiple gas and vapour species with dynamic range from ppb to 100 %

Hidden Analytical have been designing and developing the highest quality quadrupole mass spectrometer based gas analysis systems for 30 years. We have built a reputation for delivering instruments with superior sensitivity, accuracy and reproducibility together with a first class global service and applications support network.

Hidden gas analysis systems provide for real-time analysis of almost any gas and vapour including: *hydrogen, nitrogen, ammonia, hydrogen sulphide, water, oxygen, nitric oxides, sulphur oxides, hydrocarbons, fluorocarbons, VOCs, carbon dioxide, carbon monoxide, deuterium, argon, helium, xenon, krypton, chlorine, hydrogen chloride, deuterated compounds, methane, ethanol, methanol, butane, propane, propene, neon ...*



# Contents

**QIC SERIES** - Advanced Real-time Gas Analysers - Systems Overview

---

**QGA** - Quantitative Gas Analyser

---

**HPR-20 QIC R&D** - Specialist Gas Analysis System for Advanced Research

---

**HPR-20 QIC R&D<sup>plus</sup>** - with Integrated Gas Control Calibration Unit

---



**QGA** - Quantitative Gas Analyser

## Application Specific Systems

**HPR-20 QIC EGA** - Gas Analysis System for Evolved Gas Analysis in TGA-MS

---

**TGA-MS** - Mass Spectrometer Inlets for Connecting/Coupling to TGA Systems

---

**QIC SERIES GAS SAMPLING INLETS** - Pressure and Temperature Gas Sampling Options

---

**HPR-20 QIC TMS** - Transient MS for Fast Event Gas Analysis

---

**QIC BIOSTREAM** - Multi Stream Gas/Vapour Analyser for Fermentation Off-Gas Analysis

---

**HPR-40 DSA** - Membrane Inlet Mass Spectrometer for Dissolved Species Analysis

---

**HPR-60 MBMS** - Molecular Beam Sampling Mass Spectrometer for Ion and Radical Analysis

---

**HPR-70** - Batch Inlet Gas Analysis System for Discrete Low Volume Sample Analysis

---

**HPR-90** - Automated Package Cracking Analysis System for Light Bulb Gas Analysis

---

**APPLICATION SOFTWARE** - QGA, EGAssoft, MASsoft

---



**HPR-20 QIC EGA** - Gas Analysis System for Evolved Gas Analysis in TGA-MS

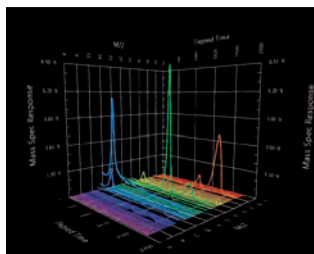

**EGASOFT** - For Evolved Gas Analysis

## QIC SERIES

# Advanced Real-time Gas Analysers

### BASELINE SYSTEM FEATURES INCLUDE:

- ▶ Sample pressure range 2 bar to 100 mbar
- ▶ Continuous sampling with inlet flow rate configurable down to 1 ml/min
- ▶ Low dead volume, heated inlet for fast response to vapours
- ▶ Species molecular weight range to 200 amu
- ▶ Fast data acquisition speeds > 500 readings/second in transient mode
- ▶ Fast 300 ms sampling response
- ▶ Time/intensity trend monitoring of multiple species
- ▶ APSI-MS soft ionisation mode for suppression of spectral fragmentation providing simplified analysis of complex mixtures
- ▶ Integration of external process data (temperature, weight, pressure)

### SYSTEM OPTIONS INCLUDE:

- ▶ Species molecular weight range to 300, 510 or 1000 amu
- ▶ Special gas sampling interface options for high pressure, high temperature applications
- ▶ Multi-stream selectors - up to 80 stream versions available
- ▶ Application specific software:
  - **QGA for quantitative gas analysis** - included as standard with QGA systems
  - **EGAssoft for evolved gas analysis** - included as standard with HPR-20 QIC EGA systems



QGA - bench-top gas analyser



HPR-20 QIC R&D



HPR-20 QIC R&D<sup>PLUS</sup>

# QGA

## Quantitative Gas Analyser

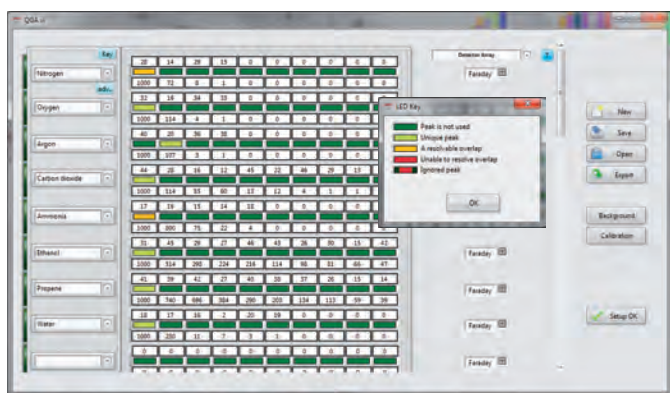

Automatic mass spectral calculator

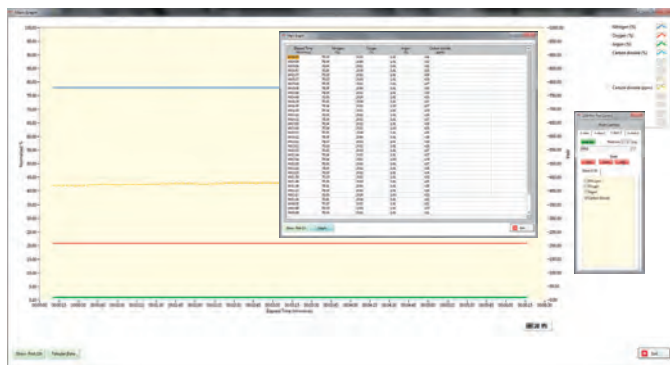

Graphical and tabular data with plot control

The Hiden QGA quantitative gas analysis system is for continuous analysis of multiple gases and vapours at pressures near atmosphere.

The Hiden QIC (quartz inert capillary) sampling interface sampling from 100 mbar to 2 bar gauge is included as standard. Operating to 200°C, the QIC flexible 2m capillary inlet provides fast response times less than 300 milliseconds for most common gases and vapours, including water and organic vapours.

The QGA system has a mass range of 200 amu (300 amu option) and a detection capability from 100% to less than 100 parts-per-billion.

The QGA system connects to a range of backing pump options including a high performance scroll pump. For flexibility the QGA will operate with fore line connection up to 10m.



QGA - bench-top gas analyser



QGA - external scroll pump

### FEATURES:

- ▶ simplified set up and operation from template files
- ▶ real-time graphical and tabular data displays
- ▶ automatic calibration with background correction
- ▶ species molecular weight range to 200 amu
- ▶ OPC data available as raw data or %/ppm quantitative output
- ▶ gas/vapour mass spectral library with intelligent scan feature for precise fragmentation pattern recording
- ▶ automatic subtraction of spectral overlaps

# HPR-20 QIC R&D

## for Advanced Research

The Hiden HPR-20 QIC R&D specialist gas analysis system is a bench-top mass spectrometer for the monitoring of evolved gases and vapours. A triple filter mass spectrometer is included providing improved resolution and abundance sensitivity with an ultimate detection limit of 5 ppb subject to spectral interference.

The HPR-20 QIC R&D is offered with a wide range of interfaces for connection to thermal equipment and is configured with Hiden's heated Quartz Inert Capillary (QIC) for continuous sampling of gases and vapours.

Backing and bypass pumping is provided by a high performance scroll pump. Gas sampling is continuous with a gas sample flow rate user configurable/selectable in the range < 1 ml/min to > 15 ml/min.



HPR-20 QIC R&D

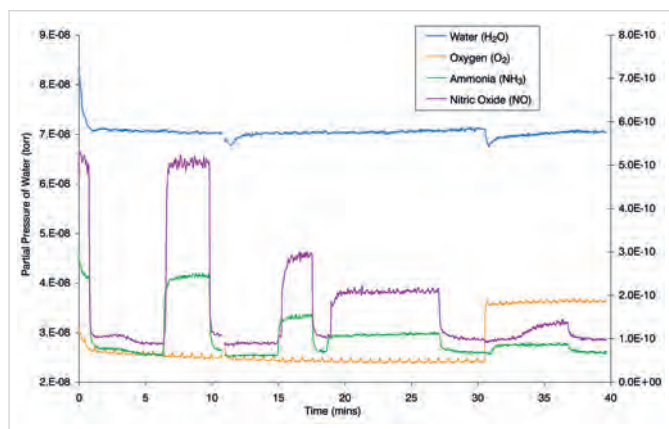

Simultaneous measurement of low ppm levels of ammonia, nitric oxide and oxygen in percentage (2%) concentrations of water

### FEATURES:

- ▶ triple filter mass spectrometer
- ▶ mass range options 200, 300, 500 or 1000 amu
- ▶ enhanced abundance sensitivity
- ▶ detection to 5 ppb
- ▶ APSI-MS soft ionisation mode

# HPR-20 QIC R&D<sup>Plus</sup> with Integrated Gas Control Unit



HPR-20 QIC R&D<sup>Plus</sup>

The HPR-20 QIC R&D<sup>Plus</sup> features the standard R&D system with the addition of an integrated gas mixing panel for control of gas mixes for calibration or reactant mixing. The additional gas control unit allows precision mixing of gases from up to 4 digital MFCs for determining accurate cracking patterns and relative sensitivity (RS) factors of analysis gases. Control, setpoint, readback etc, is fully integrated in MASsoft also giving control over MFC gas conversion factors for the use of different gases with the same MFCs.

The gas control unit can also be used to control the gas supply to users' own reactor systems allowing complete control of gas blending and data acquisition in one software package (furnace control options are also available).

The gas control unit can also be supplied separately for integration into existing Hiden gas analysis systems.

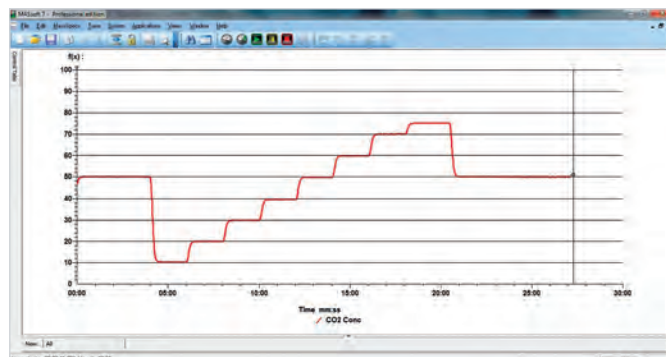

Gas control calibration

## FEATURES:

- ▶ 4 high precision digital MFCs
- ▶ fully software controlled
- ▶ integrated positive shutoff valves
- ▶ software controlled switching valves to ensure continuous gas flow to either analysis or vent lines
- ▶ optional temperature inputs
- ▶ digital output for control of injection valves (optional)

# HPR-20 QIC EGA

## for Evolved Gas Analysis in TGA-MS



HPR-20 QIC EGA

The Hiden HPR-20 QIC EGA gas analysis system is configured for continuous analysis of evolved gases and vapours from thermogravimetric analysers (TGA). Interface systems are available for most TGA instruments. The TGA interface includes re-entrant furnace sampling, providing close coupling to the TGA furnace region for optimized evolved gas/vapour analysis.

Custom designed interfaces are available for special requirements with alternative systems being offered for applications requiring direct sampling from advanced thermogravimetric analysers operating at higher pressures to 30 bar.

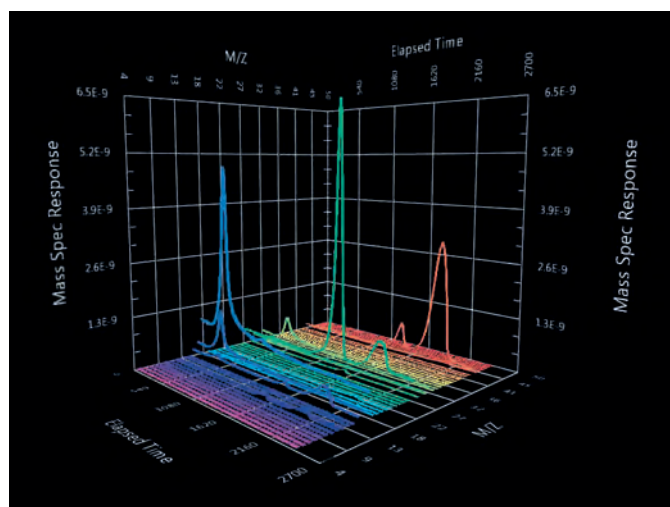

EGAssoft 3D bar mode

### FEATURES:

- ▶ enhanced pumping for light gases
- ▶ heated inlet for non-tailing response to desorbed gases and vapours
- ▶ control of ionisation energy parameters for simplification of cracking patterns
- ▶ custom, low dead volume interface to specific manufacturers' TGA systems
- ▶ optimised data acquisition using EGAssoft
- ▶ mass range option 300 or 510 amu



## TGA-MS

# MS Inlets for Coupling to TGA Systems

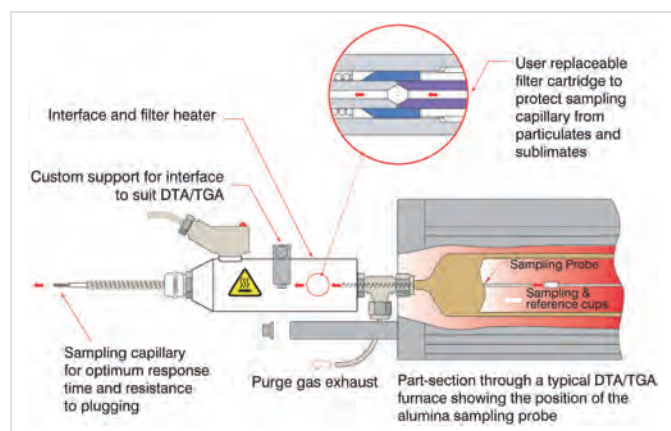

Typical TGA inlet

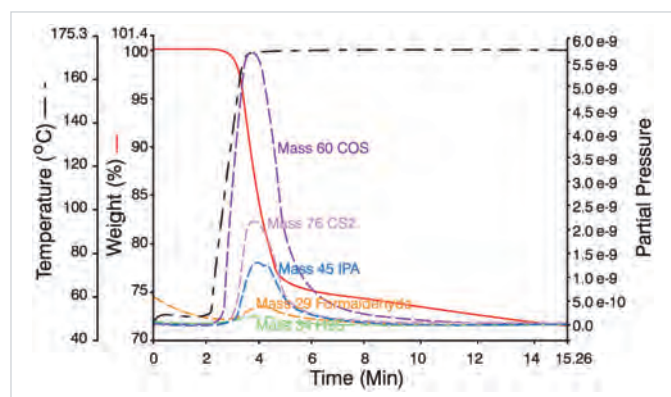

TGA-MS plot

All of Hiden's capillary inlet gas analysers may additionally be equipped with fast response, low dead volume interfaces for the most popular TGA equipment.

Each interface has been custom engineered in collaboration with TGA manufacturers and includes, where necessary, robust clamping arrangements and in-line heated filter assembly between the outlet of the TGA and the MS capillary inlet.

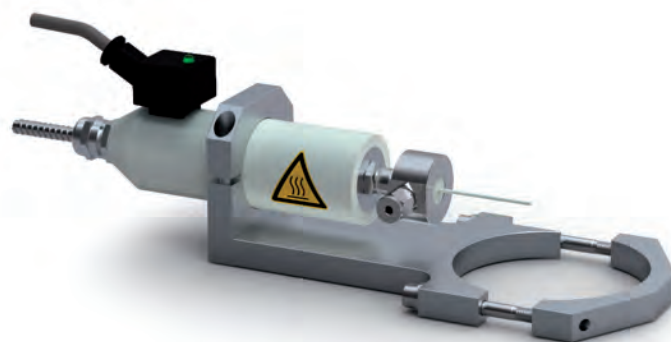

### FEATURES:

- ▶ minimum dead volume
- ▶ controllably heated sample inlet - no cold spots
- ▶ inert materials
- ▶ high performance gas handling for operation with low molecular weight gas components ( $H_2$ , He) and for flow matching with the TGA

# QIC SERIES INLETS

## Gas Sampling Options

### PRESSURE AND TEMPERATURE

Hidden offer a variety of inlet options for the QIC Series gas analysis systems. Capillary inlets are available to sample at pressures both above and below atmospheric pressure. High pressure inlets are offered for sampling gases and vapours up to 30 bar, and special capillaries are offered for low pressure sampling down to 1 mbar. There is also a high temperature version of the QIC Inlet available for demanding applications.

Other options include heated capillary extensions, heated multi-stream inlets and hot-zone adaptors for sampling from furnaces (for example TGA-MS).

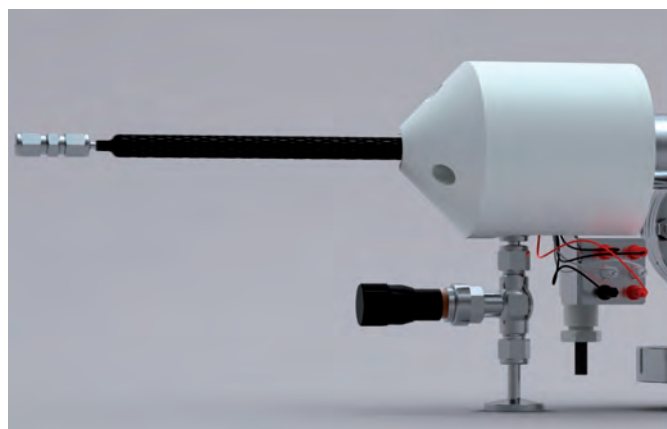

Low pressure sampling inlet (10 to 1 mbar version)



Proteus 40-way and 80-way rotary valve



Hot-zone inlet with heated filter (2 micron)



HT/HP inlet (up to 30 bar at 200 °C)

### FEATURES:

- ▶ high temperature capillary inlet
- ▶ high pressure/high temperature sampler
- ▶ low pressure capillaries
- ▶ heated capillary extension
- ▶ hot-zone inlets
- ▶ multi-stream selectors - 8, 16, 20, 40 and 80-way
- ▶ flexible RGA inlet for residual gas analysis at high vacuum

# HPR-20 QIC TMS

## Transient MS for Fast Event Gas Analysis



HPR-20 QIC TMS transient MS QIC inlet

The Hiden HPR-20 QIC TMS Transient MS is configured for fast event gas analysis of gases and vapours at pressures near atmosphere. Ideal for fast gas switching experiments the MS features the Hiden QIC quartz-lined 0.9 m sampling interface. The inlet, operating at 200 °C, provides response times of less than 150 ms to changes in gas composition with a 5 decade response time in < 200 ms.

The QIC inlet is coupled directly to Hiden's Pulse Ion Counting (PIC) digital MS which is capable of measurement speeds of up to 500 data points/s over the entire 7 decade dynamic range.

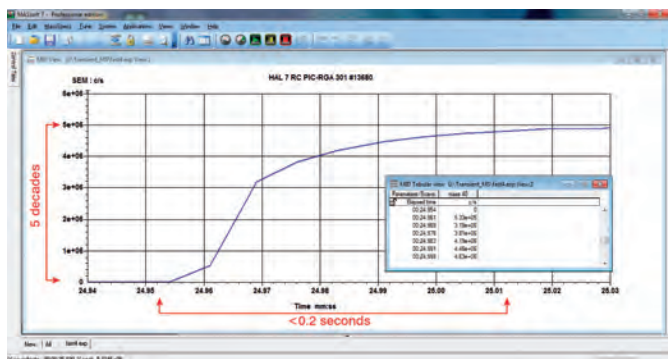

HPR-20 transient MS data - > 5 decades response in < 0.2 s

### FEATURES:

- ▶ 1 m fast response QIC capillary - 150 ms response time
- ▶ open ion source and optimised pumping configuration for fast response
- ▶ digital PIC detector - 7 decades continuous log scale
- ▶ detection of low ppm to high % levels in < 200 ms

# QIC BioStream

## for Fermentation Off-Gas Analysis

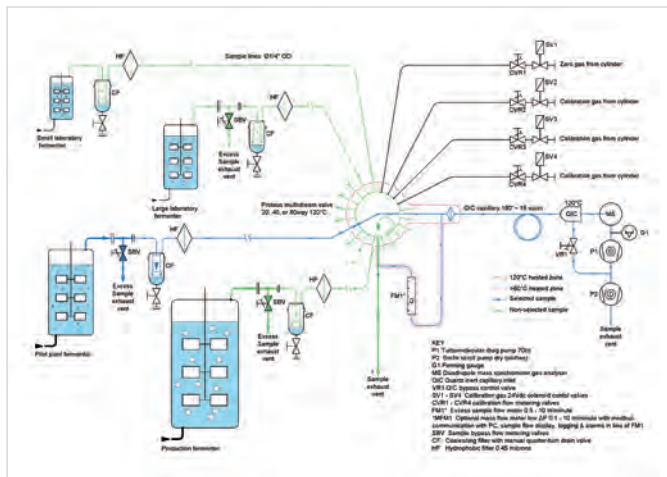

### FERMENTER SAMPLING

A typical system setup for sampling from multiple fermenters, configured with sample conditioning components, sample lines and flow control valves to accommodate reactors with flows from 100 ml/min up to > 10 L/min.

### FEATURES:

- ▶ Hiden 3F ultra-stable mass spectrometer
- ▶ Proteus 20, 40 or 80-way multi-port switching options
- ▶ rapid port switching
- ▶ low flow configuration - from 4 ml/min
- ▶ high flow configuration - to 10 L/min
- ▶ quantitative gas analysis of up to 16 species
- ▶ dissolved species analysis
- ▶ OPC Server technology - for process control
- ▶ OUR - Oxygen Uptake Rate
- ▶ CER - CO<sub>2</sub> Evolution Rate
- ▶ RQ - Respiratory Quotient

The Hiden QIC BioStream is a complete, multi-stream gas composition monitoring system. Capable of analysing gas streams at flow rates from 4 ml/min up to 10 L/min the system is suited to a range of applications including fermentation off-gas analysis, biogas production monitoring and bio-enzyme production.

The system features Hiden's state-of-the-art "Proteus" Multi-stream selector valve coupled with a precision, ultra-stable triple filter mass analyser. Fast data acquisition and low internal dead volume allows switching times as low as 1 second per stream.

Hiden's QGA Pro quantitative gas analysis software features automatic calibration routines for accurate quantitative analysis. Gas/vapour mass spectral libraries and automatic subtraction of spectral overlaps allow for precise fragmentation pattern recording.



QIC BioStream system - mobile cart



QIC BioStream-C - bench-top

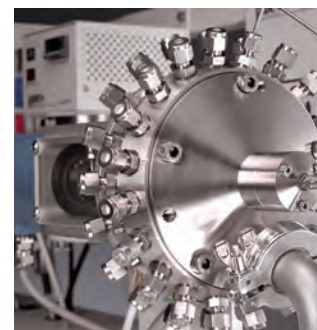

Proteus multi-stream selector

# HPR-40 DSA

## for Dissolved Species Analysis

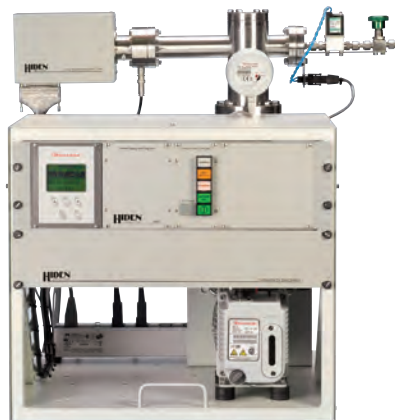

HPR-40 DSA

The Hiden HPR-40 DSA Membrane Inlet Mass Spectrometer (MIMS) is a compact bench-top gas analysis system for real-time quantitative analysis and monitoring of dissolved/evolved gases.

The system offers the facility for analysis to sub-ppb (parts per billion) levels and is suited to gas analysis applications where sample volume is small and for environmental applications where detection of a low concentration level is required. Both insertion probe inlets and circular membrane carrier inlets are available to address a broad range of applications.

The inlet probe uses a special membrane that allows small levels of the dissolved species to pass through it and into the ion source of a high precision quadrupole mass spectrometer.

A manual isolation valve allows for control of the sampling and a solenoid safety valve provides protection for the mass spectrometer and vacuum system in case of membrane failure.

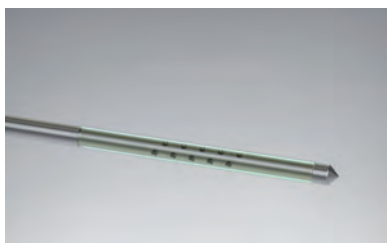

Interchangeable membrane inlet probe types

### FEATURES:

- ▶ analysis of dissolved species with mass range 200 amu (300 amu option)
- ▶ sub parts per billion detection levels
- ▶ high precision and stability species ratio measurements (e.g. marine de-nitrification studies)
- ▶ soil core analysis
- ▶ fermentation process analysis
- ▶ water analysis in estuary, river or reservoir
- ▶ groundwater contamination studies
- ▶ methane production control
- ▶ microbiological/enzyme activity studies
- ▶ environmental monitoring

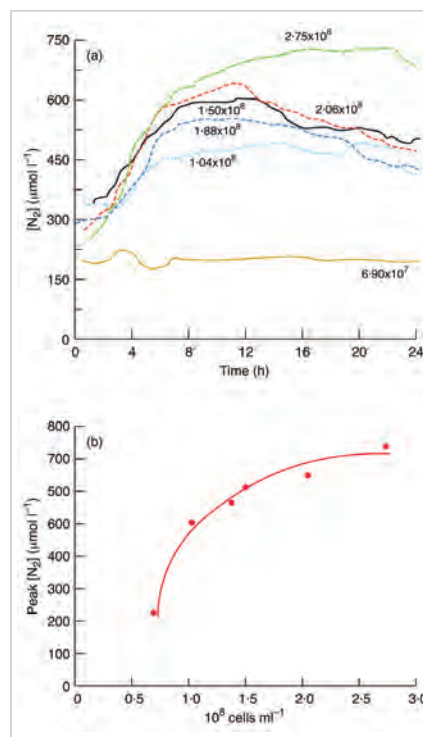

Denitrification by *Pseudomonas stutzeri* in a sterile lake water microcosm supplemented with succinate and nitrate  
JR Firth and C Edwards  
2000 *Journal of Applied Microbiology* **88** 853-859

# HPR-60 MBMS

## for Ion and Radical Analysis

The Hiden HPR-60 molecular beam mass spectrometer is a compact skimmer inlet MS for the analysis of reactive gas phase intermediates. Radicals are sampled via a multistage differentially pumped skimmer inlet and transferred to the MS ion source with minimal interaction with other species and without wall collisions. Customisable inlets allow connection to many different reactor systems, including atmospheric plasmas.

The skimmer system, combined with a Hiden triple filter precision mass spectrometer, offers a sampling system with ultra fast response and high accuracy.

- ▶ catalytic reactors
- ▶ reaction kinetics
- ▶ study of transients
- ▶ plasma chemistry

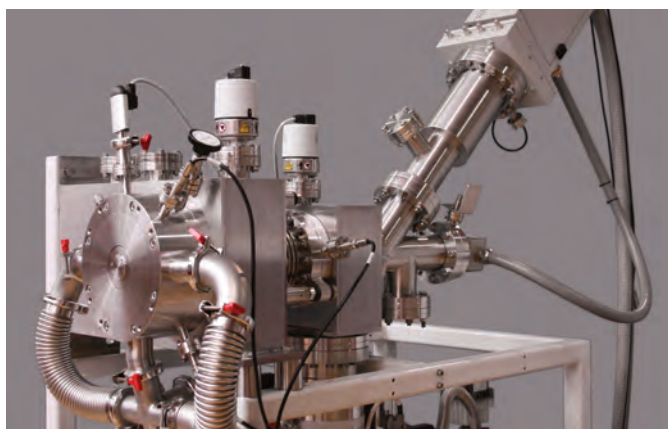

HPR-60 MBMS

### FEATURES:

- ▶ molecular beam sampling at atmospheric pressure
- ▶ +ve and -ve ion analysis
- ▶ user replaceable skimmer cones (can be biased)
- ▶ electron attachment ionisation mode for the study of electro-negative radicals
- ▶ APSI-MS soft ionisation mode for radicals analysis
- ▶ mass range options: 300, 510 or 1000 amu
- ▶ energy range options: 100 eV or 1000 eV

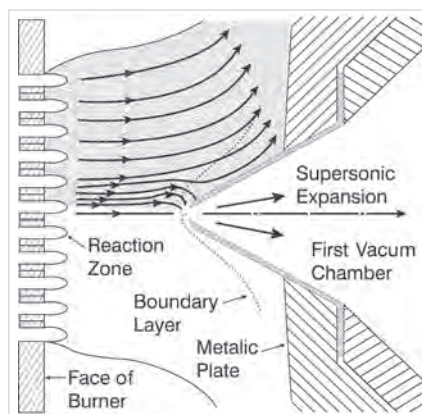

HPR-60 MBMS schematic

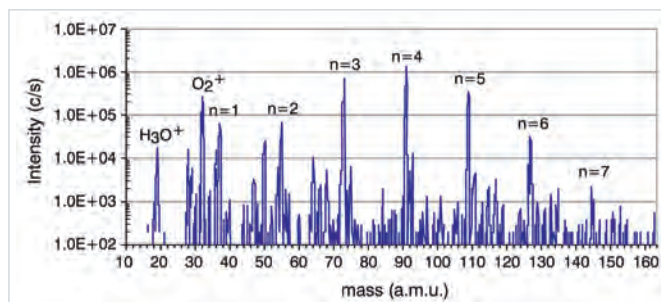

Hydrated cluster ions from atmospheric dielectric barrier discharge

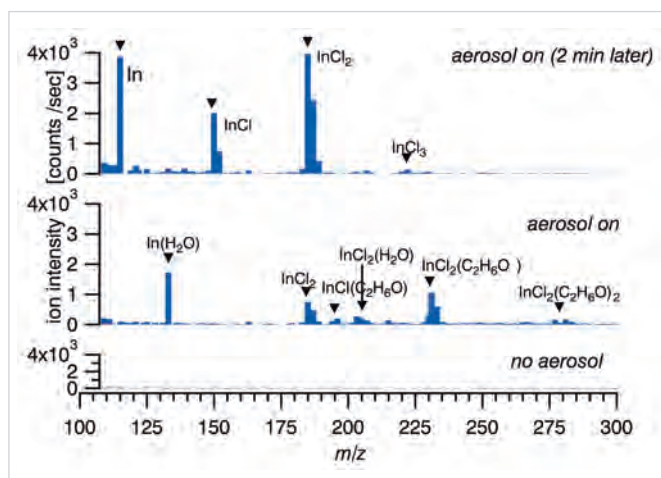

Mass spectra of the indium containing fractions of the aerosol of  $\text{InCl}_3$  in ethanol sprayed at room temperature. The lowest row is the background measurement in the chamber before aerosol generation. The middle spectrum is directly recorded as the aerosol is switched on and the top spectrum is measured after 2 min of spraying into a tube held at room temperature.

S Gledhill *et al.* 2011 *Thin Solid Films* **519** 6413-6419

# HPR-70

## for Discrete Low Volume Sample Analysis

The Hiden HPR-70 compact bench-top batch inlet gas analysis system is suitable for the analysis of discrete gas samples.

A small quantity of gas, usually at or close to atmospheric pressure, is sampled using an automated batch inlet. After expansion and consequent pressure drop the gas is analysed using a high sensitivity 500 amu quadrupole mass spectrometer.

Most minor components in the gas mixture can be measured at levels of 5 ppm or above.

- ▶ landfill and environmental monitoring
- ▶ nuclear gas analysis
- ▶ head space measurements
- ▶ fuel cell analysis
- ▶ geological sample

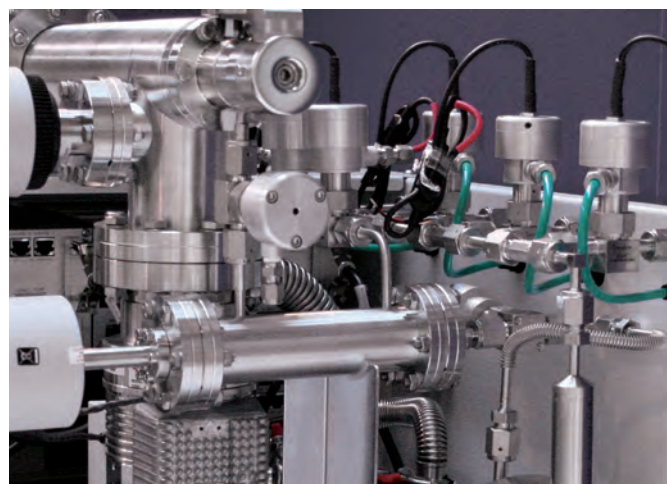

HPR-70 batch inlet

Parameters/Scans:	Argon 40	Hydrogen 2	Water 18	N2/CO 28	Oxygen 32	CO2 44	Ar, % 0.4	H2_ppm 0.4	H2O_ppm 0.4	N2/CO_ppm 0.4	O2_ppm 0.4	CO2_ppm 0.4
Elapsed time	mbar	mbar	mbar	mbar	mbar	mbar						
00:12:341	2.357E-06	8.731E-09	2.311E-09	1.926E-09	4.196E-11	3.653E-10	9.972E+01	1.697E+03	1.317E+02	7.602E+02	1.340E+01	1.507E+02
00:23:478	3.888E-06	8.803E-09	2.077E-09	1.793E-09	4.131E-11	3.598E-10	9.984E+01	1.048E+03	1.988E+01	4.273E+02	7.962E+00	9.005E+01
00:34:615	3.857E-06	8.616E-09	2.110E-09	1.790E-09	4.074E-11	3.486E-10	9.984E+01	1.009E+03	2.857E+01	4.300E+02	7.882E+00	8.790E+01
00:45:745	3.826E-06	8.524E-09	2.031E-09	1.689E-09	4.094E-11	3.518E-10	9.985E+01	9.929E+02	8.113E+00	4.072E+02	7.998E+00	8.943E+01
00:56:863	3.812E-06	8.452E-09	2.105E-09	1.678E-09	4.081E-11	3.543E-10	9.985E+01	9.775E+02	2.750E+01	4.056E+02	7.992E+00	9.040E+01
01:08:003	3.808E-06	8.328E-09	2.045E-09	1.754E-09	4.082E-11	3.510E-10	9.985E+01	9.460E+02	1.185E+01	4.260E+02	8.002E+00	8.965E+01
01:19:122	3.810E-06	8.306E-09	1.989E-09	1.699E-09	4.042E-11	3.519E-10	9.986E+01	9.399E+02	-2.771E+00	4.114E+02	7.895E+00	8.986E+01
01:30:258	3.821E-06	8.176E-09	2.043E-09	1.764E-09	4.040E-11	3.494E-10	9.986E+01	9.032E+02	1.128E+01	4.274E+02	7.866E+00	8.893E+01

HPR-70 batch inlet sampling schematic

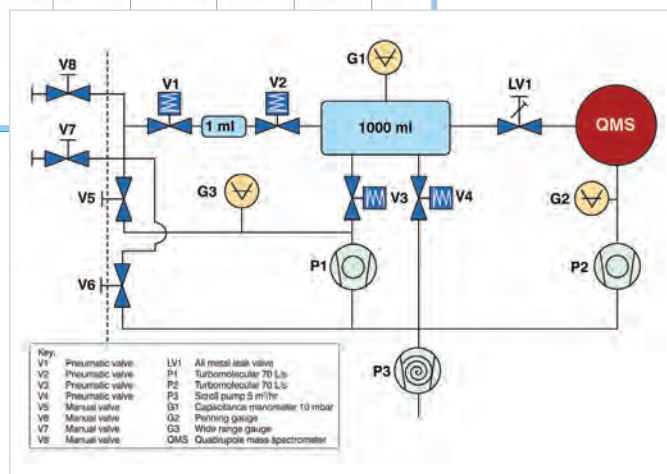

### FEATURES:

- ▶ dual compound turbo pumps and oil-free, totally dry backing pump
- ▶ automatic dosing, expansion and accurate sampling
- ▶ total sample pressure measurement with capacitance manometer
- ▶ optional aliquot filling facility
- ▶ 1 litre sample reservoir
- ▶ 1 ml injection reservoir
- ▶ optional calibration lines

# HPR-90

## for Light Bulb Gas Analysis

The HPR-90 automated package cracking analysis system is a complete system optimised to analyse gas within sealed volumes such as light bulbs. The HPR-90 system can be custom configured to suit small automobile bulbs through to fluorescent tubes.

This system comprises a piercing unit, UHV manifold and sampling system, a triple filter quadrupole mass spectrometer and all associated control equipment on a mobile cart.

- ▶ **fill gas analysis**
- ▶ **quality control studies**
- ▶ **sealed volumes analysis**
- ▶ **automatic data reporting formats**



**HPR-90** automated package cracking analysis system

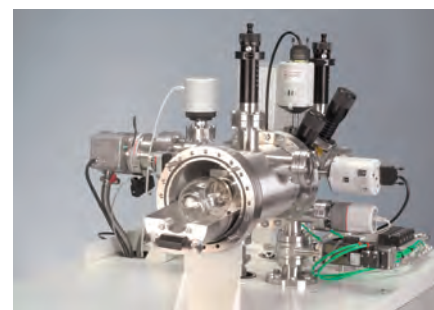

**HPR-90** carrier with light bulb

### FEATURES:

- ▶ Hiden HAL 3F/301 triple filter quadrupole mass spectrometer
- ▶ interchangeable cracking chamber with cracking mechanism
- ▶ automated inlet with automatic leak valve including calibration gas inlet
- ▶ high sensitivity to < 10 ppm in a sealed package at 10 mbar
- ▶ data can be collated with serial numbers from sample bulbs
- ▶ mass range options to 1000 amu
- ▶ automatic data reporting formats



# QGA PROFESSIONAL SOFTWARE

## for Quantitative Gas and Vapour Analysis



QGA PROFESSIONAL main screen

QGA Professional Edition software is an application specific software package for quantitative gas and vapour analysis providing real-time continuous analysis of up to 16 species with species concentration measured in the range 0.1 ppm to 100 %. The software can be used in either single stream mode or multi-stream mode for use with multi-stream gas selection valves with up to 80 streams.

The software features easy to use calibration routines for both cracking pattern and Relative Sensitivity (RS) measurement. Analysis is performed using simple template setup routines and features automatic spectral removal algorithms and correction factor determination to output quantitative data. Integrated inputs from external devices such as CO analysers make the software versatile for a whole range of gas analysis applications.

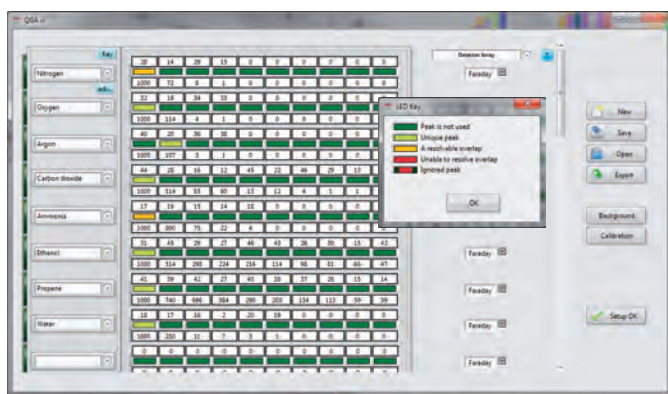

Automatic mass spectral analysis setup

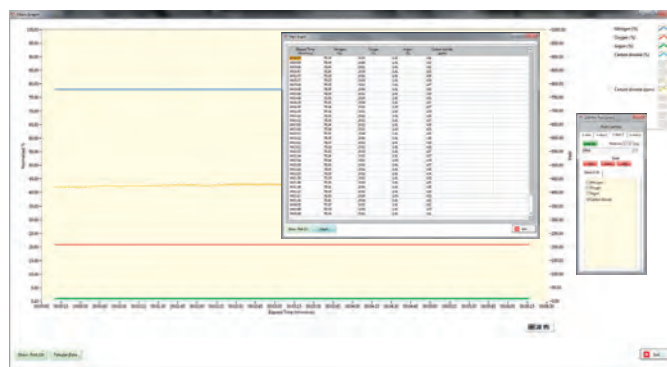

Graphical and tabular data with plot control

### FEATURES:

- ▶ quantitative gas analysis of up to 16 gases
- ▶ 10 peak spectral library with intelligent library scan feature
- ▶ component gas calibration with background correction
- ▶ automatic triggering of analysis from an external input read multiple inputs, temperature or pressure for example
- ▶ x-axis can display time or an external input, e.g. temperature

# EGAsoft SOFTWARE for Evolved Gas Analysis

Hidden EGAsoft, a complete, application specific, software package for Evolved Gas Analysis data acquisition and analysis. The software has been designed to meet the specific requirements of Evolved Gas Analysis, e.g. TG-MS, DSC-MS. The software only features the settings that are required making it easy to use for even novice users. The 3D graphing of bar scan data ensures that trends can be easily identified from the decomposition of unknown substances. Hidden collaborates with a range of TGA manufacturers to ensure the compatibility of the file export functions with their software.

In addition to the acquisition features the software also features some post process analysis functions such as peak integration and peak deconvolution with multiple Gaussian peaks.

- ▶ TGA-MS
- ▶ DSC-MS
- ▶ Temperature Programmed Desorption (TPD)
- ▶ Thermal Decomposition

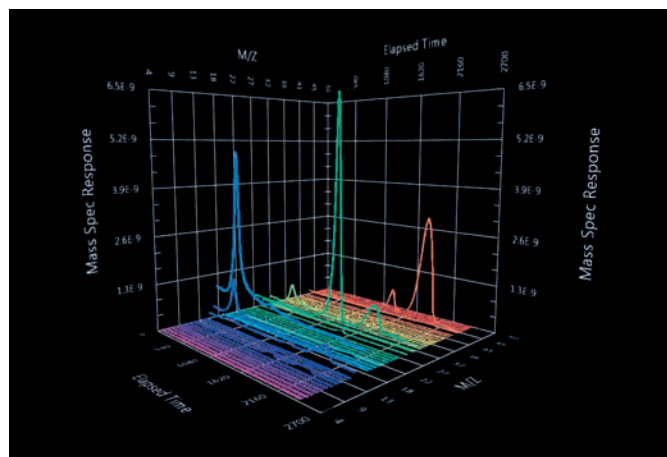

EGAsoft 3D bar mode

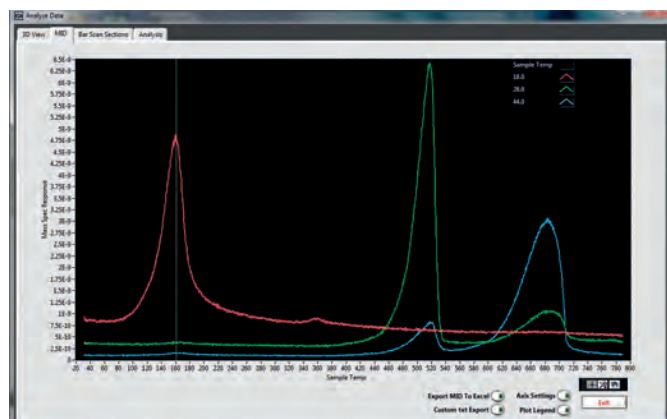

EGAsoft MID view

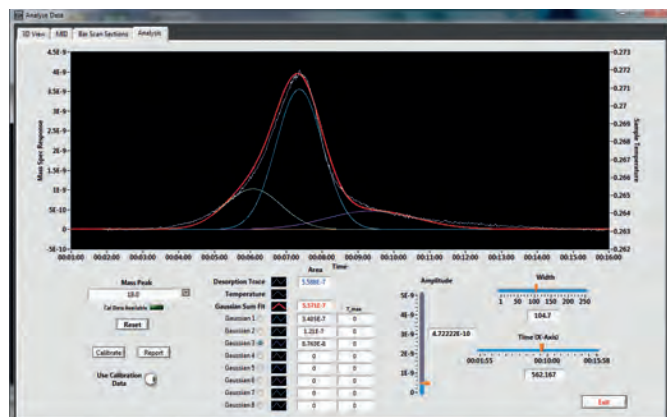

EGAsoft peak integration functions

## FEATURES:

- ▶ 3D bar scan view for easy determination of trends in bar data
- ▶ simple automatic export in formats specific for import to any TGA/DSC manufacturer
- ▶ automatic spectral deconvolution in MID mode
- ▶ peak integration and data analysis routines
- ▶ auto-sequencing of MS data acquisition files e.g. for use with auto samplers
- ▶ auto start/stop and temperature inputs where output signals are available
- ▶ mass spectrometer ionisation energy control for soft ionisation of complex mixtures

# MASsoft PROFESSIONAL Control Software

All Hiden instruments are supplied with MASsoft mass spectrometer control software. MASsoft Professional is a multilevel software package allowing both simple control of mass spectrometer parameters and complex manipulation of data and control of external devices.

Quick start tabs with user configurable single key start functions means novice users can start collecting data within seconds.

Scan templates allow fast set up of scans from previous similar experiments.

User selected alarm facilities (including status indication with message send and output drive capability) provide powerful control for process environments.

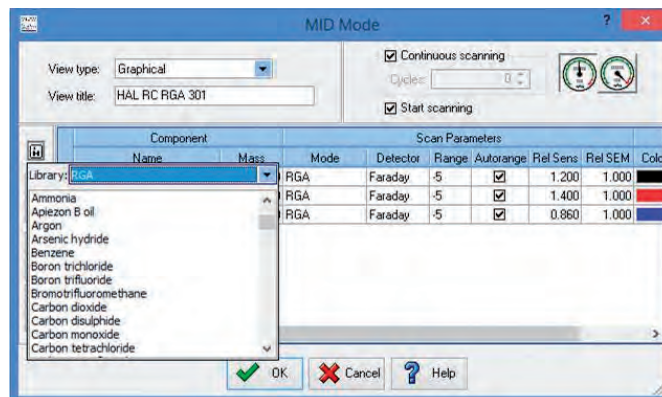

Trend analysis (MID) setup

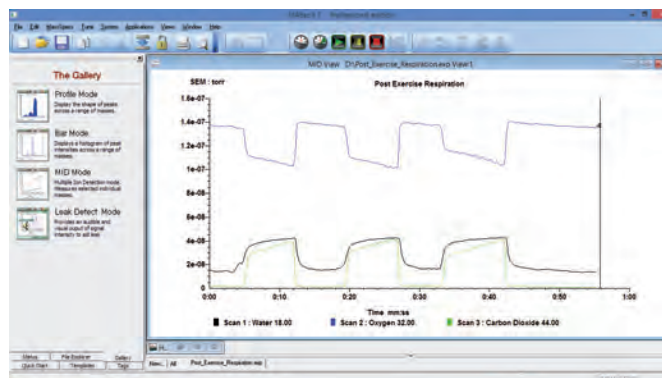

Scan gallery

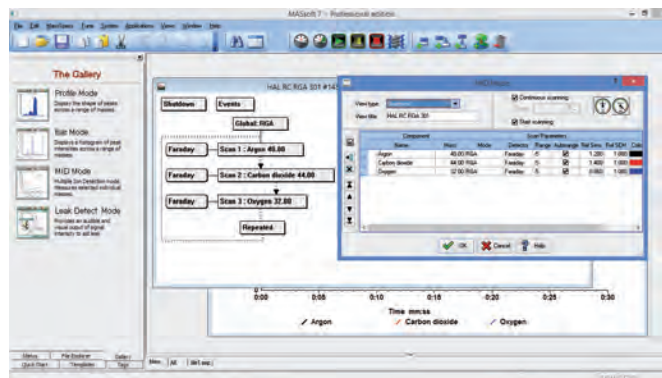

MASsoft Professional - overview

## FEATURES:

- ▶ mass spectrometer ionisation energy control for soft ionisation of complex mixtures
- ▶ export data to NIST MS database for analysis of unknowns
- ▶ export to external data analysis software, e.g. Excel, Origin
- ▶ control of external devices, e.g. MFCs, gas switching/sampling valves and furnace PID controllers
- ▶ output data as percentage or ppm files
- ▶ real-time subtraction of overlapping peaks

# Hidden **APPLICATIONS**

Hidden's quadrupole mass spectrometer systems address a broad application range in:

## **GAS ANALYSIS**

- ▶ dynamic measurement of reaction gas streams
- ▶ catalysis and thermal analysis
- ▶ molecular beam studies
- ▶ dissolved species probes
- ▶ fermentation, environmental and ecological studies

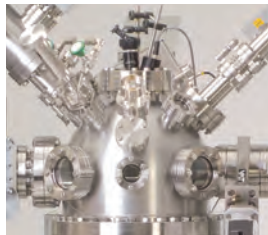

## **SURFACE ANALYSIS**

- ▶ UHV TPD
- ▶ SIMS
- ▶ end point detection in ion beam etch
- ▶ elemental imaging – 3D mapping

# **HIDDEN**

**ANALYTICAL**

Hidden Analytical Ltd.  
420 Europa Boulevard  
Warrington WA5 7UN England

**T** +44 [0] 1925 445 225  
**F** +44 [0] 1925 416 518  
**E** [info@hidden.co.uk](mailto:info@hidden.co.uk)  
**W** [www.HiddenAnalytical.com](http://www.HiddenAnalytical.com)



## **Sales Offices:**

We have sales offices situated around the globe. **Visit our website for further information.**



## **PLASMA DIAGNOSTICS**

- ▶ plasma source characterisation
- ▶ etch and deposition process reaction kinetic studies
- ▶ analysis of neutral and radical species



## **VACUUM ANALYSIS**

- ▶ partial pressure measurement and control of process gases
- ▶ reactive sputter process control
- ▶ vacuum diagnostics
- ▶ vacuum coating process monitoring

