

GB

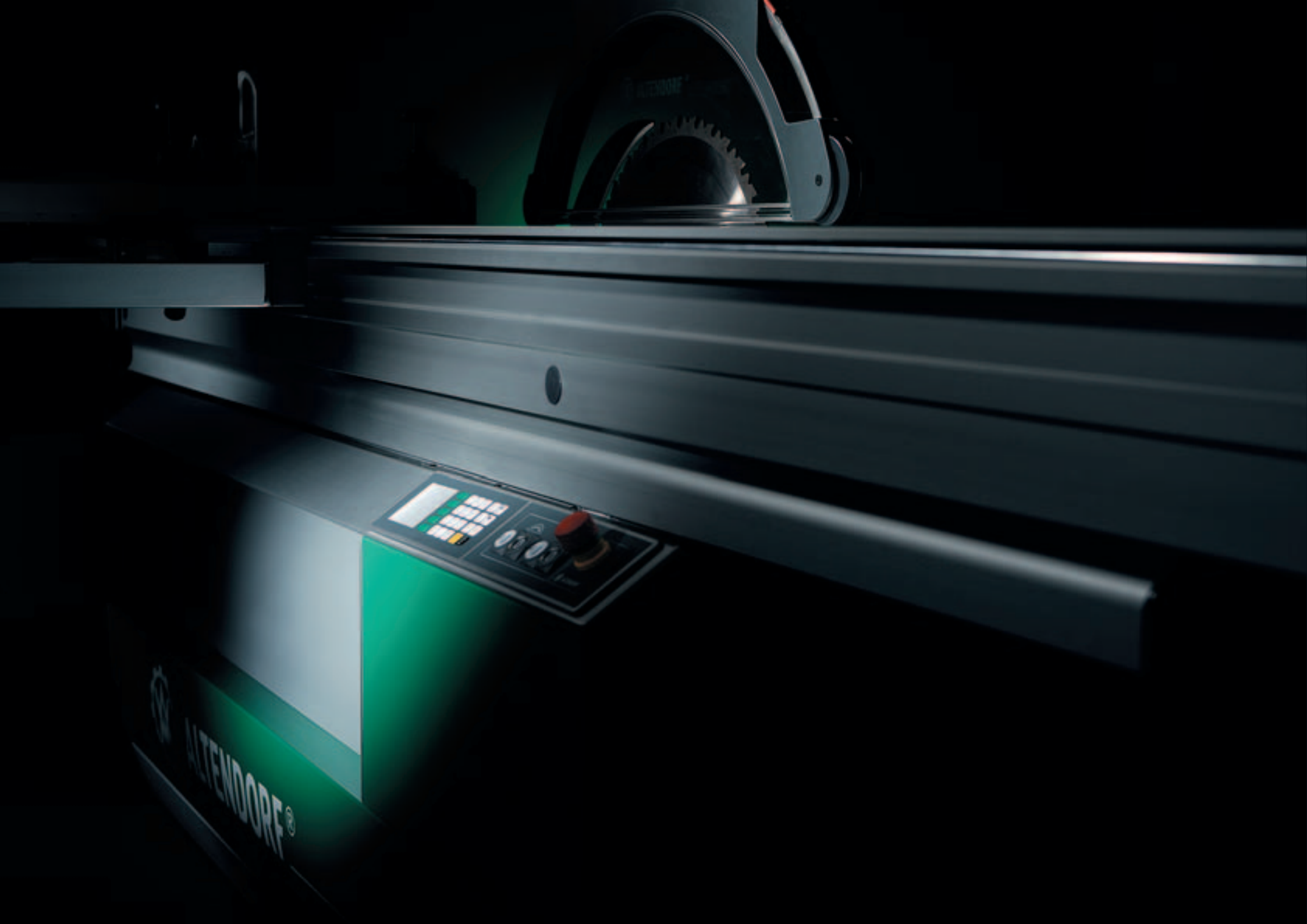



ALENDORF®

# CONTENTS

08	F 45 Quality Features
10	F 45
11	F 45 ELMO
12	F 45 Equipment Overview
20	Options Pack F 45 I
22	Options Pack F 45 II
24	Options Pack F 45 III
26	F 45 Controls
28	F 45 ELMO Equipment Overview
36	F 45 ELMO III
38	F 45 ELMO IV
40	F 45 ELMO Controls
41	F 45 ELMO Controls/IT Integration
42	Options
54	Technical Data
58	About Altendorf













## A firm foundation is all-important.

■ **New: Machine frame.** The new generation of saws has the most torsion-resistant machine frame Altendorf have ever built. The new frame design means even smoother running and stability. The machine frame is fully enclosed with the connection socket for the lower extraction hose located in a fixed position on the outside of the machine frame.



■ **New: Saw unit.** The Altendorf saw unit is the engineering heart of all our saws. It is a powerhouse produced with the latest manufacturing technology. The saw shaft runs incredibly smoothly: this is because it is electronically balanced as a fully assembled unit, and extensive use is made of cast components. The high-precision vertical movement of the unit is linear with maintenance-free guide bearings. The robust tilt quadrants incorporate the traditional Altendorf tongue and groove connection system, which allows the whole unit to tilt easily and precisely to exactly the correct angle. See page 45 for more details.

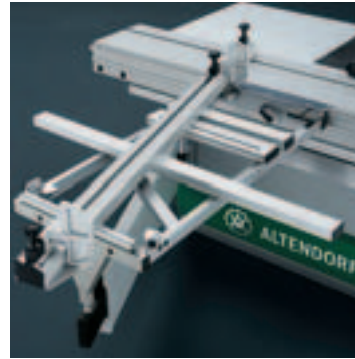

■ **Crosscut-mitre fence:** This patented Altendorf fence, with integral length compensation, can cut both square cuts and mitre cuts. The measuring scales are sloped towards the operator for easy visibility. The two solid, no-play flip stops move smoothly and can be set anywhere along the fence section for measurements up to around 1 700 mm. For larger dimensions up to 3 500 mm, the outer stop docks into the roller-stabilized telescopic extension. This extension is equipped with integral support wings for narrow unstable workpieces. See page 48 for more details.



■ **New: Extraction hood.** The new extraction hood is technically state-of-the-art and has been praised in all its aspects by independent test bodies, in particular for its optimized airflow. The hood uses linear guidance for easy vertical adjustment, and can also be swung out of the way of the cutting line from the operator position. Switching between wide and narrow hoods doesn't involve a complete hood change, just a straightforward switch of the relevant half, which locks and unlocks in one simple click. The new hood will allow cutting heights of up to 200 mm (without scoring unit).



■ **Rip fence with fine adjustment:** Setting the fence is easy; the precision fine adjustment makes for great accuracy. The hard chrome-plated round bar ensures the fence moves smoothly. If you need to divide large panels, you can swing the rip fence away under the level of the machine table. See page 51 for more details.

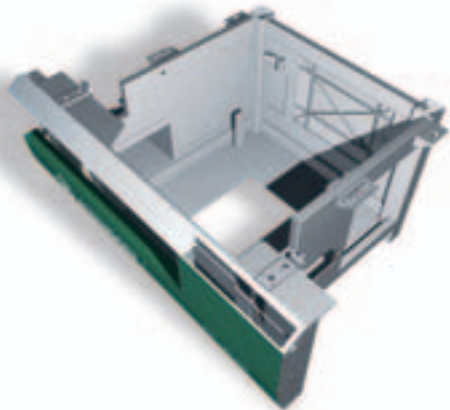



## The Altendorf sliding table: Smooth running and precise guiding.

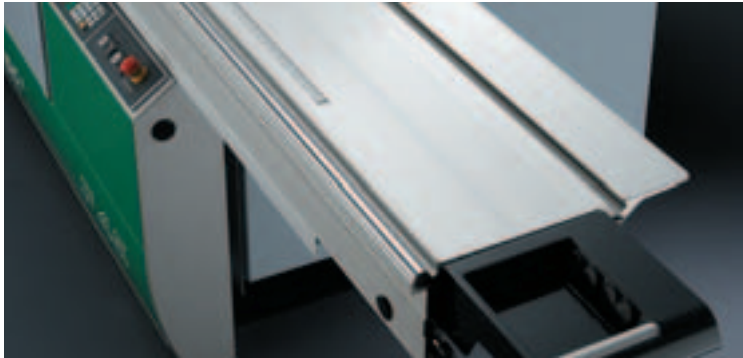

■ **Sliding table:** The Altendorf sliding table is renowned for its smooth and exact running. This is hallmark of an Altendorf, and it all comes down to design: the table runs on large dumb bell rollers sandwiched between hard chromed guide bars, guaranteeing absolute precision. The system's large rollers ensure smooth action, meaning the table takes less effort to move and glides as securely as if it were on rails. This quality running will endure decades of heavy load bearing in the constant presence of dust and chips, and it needs virtually no maintenance. Each time the table moves, the brush fitted to the upper part automatically cleans the round guide bars. The system operates without any lubrication. The table's hollow multi-chamber aluminium extrusion guarantees optimal torsion resistance and rigidity. See page 46 for more details.

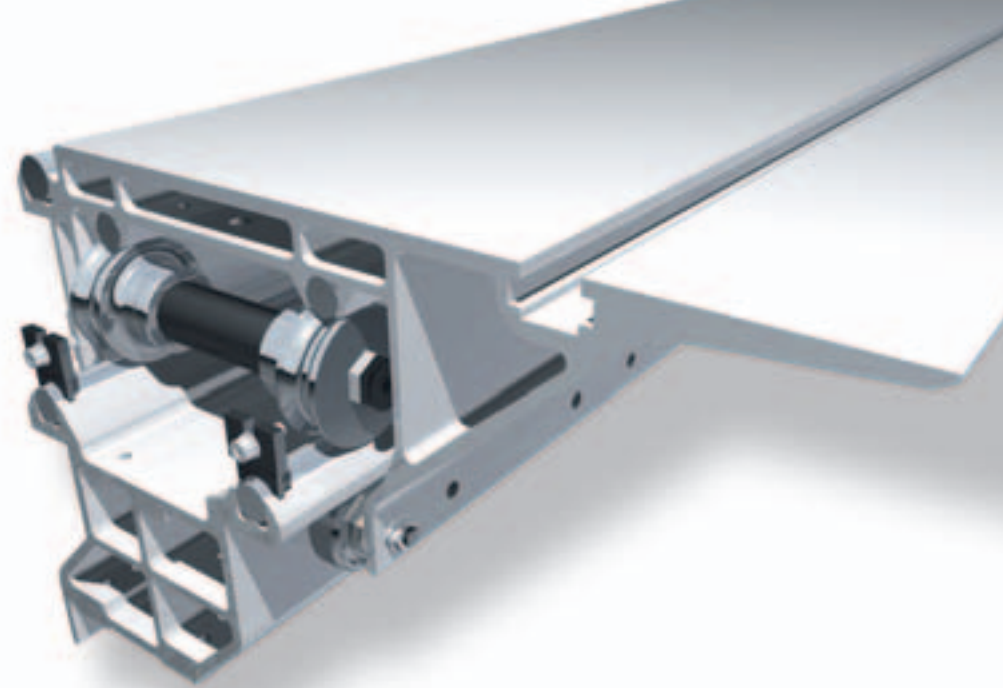

■ **The principle of the sliding table.** Wilhelm Altendorf discovered in 1906 that the only way to achieve an absolutely straight edge, which in turn is required as a reference edge for precise rip and crosscutting, was to guide a static workpiece through the rotating saw blade by holding it firmly on a moving support. To begin with, Wilhelm Altendorf used a wooden push slide system to guide the workpiece. In the 1950s, Altendorf developed the double roller carriage, for which the company held a patent for 30 years. We know of no better system than the double roller carriage in terms of smooth running, precision, torsion-resistance and low maintenance. Over 120 000 users worldwide agree with us.



10 F 45

A new generation of Altendorfs –  
the legend lives on!



*The new F45:  
Striking design and user friendliness  
in one. The large LCD display on the  
control panel is immediately noticeable.*



*The new F45 ELMO:*

*Elegance and confidence. Setting a new standard for convenience, ergonomics and productivity.*

THE F45



- Equipment Overview
- Options Pack F 45 I
- Options Pack F 45 II
- Options Pack F 45 III



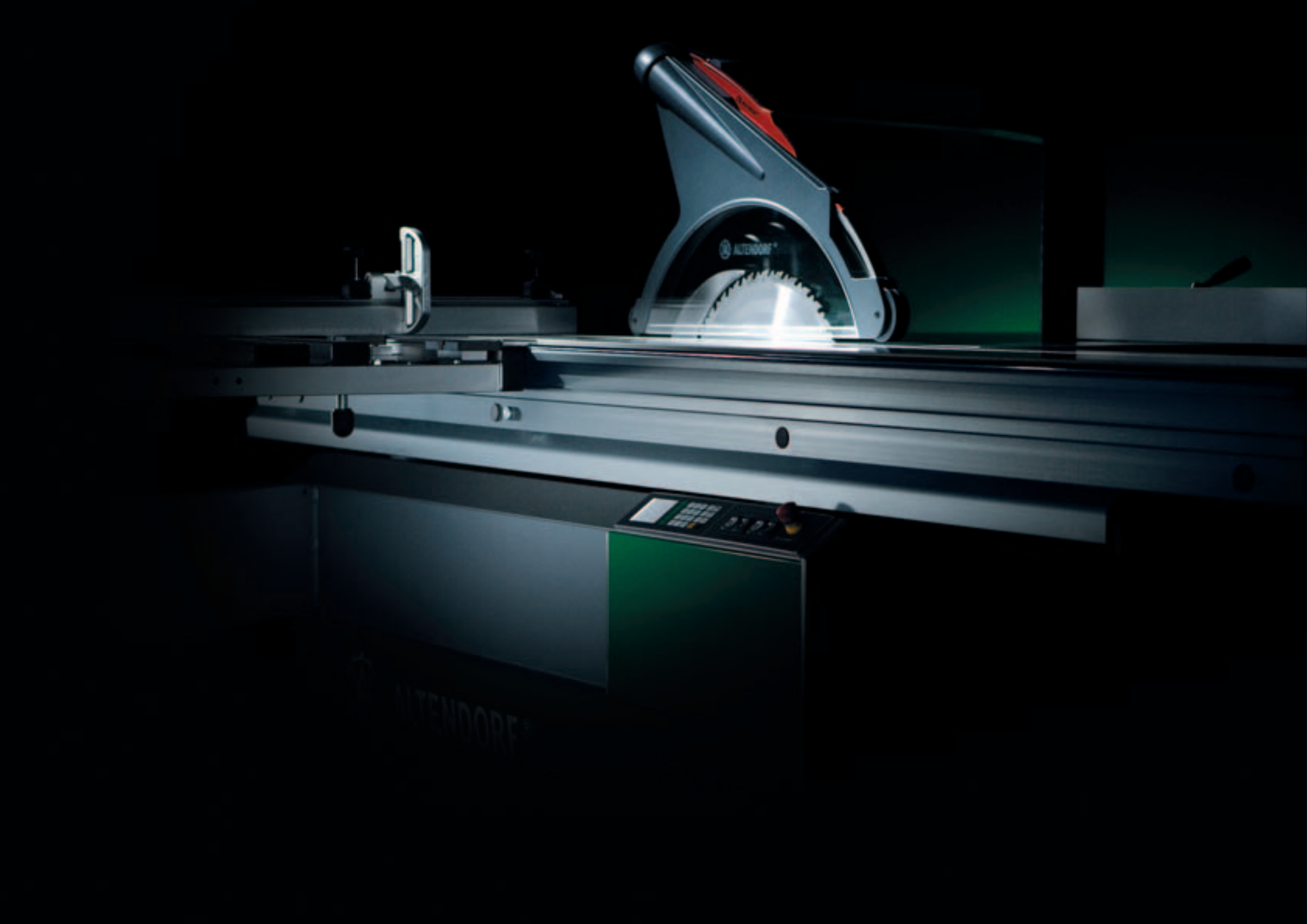







ALTENDORF®





Extraction hood

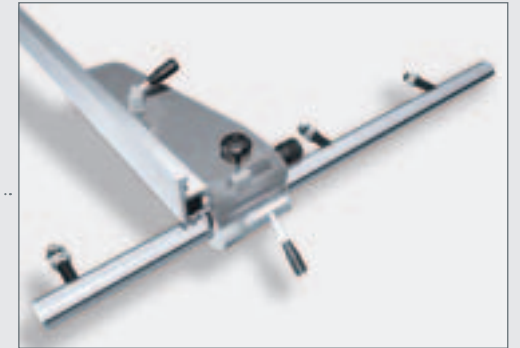

Rip fence



Crosscut-mitre fence

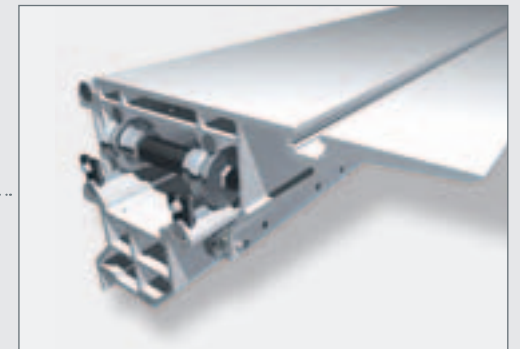

Sliding table



## Flexibility – F 45 available as individual modules.

■ **The Altendorf system** permits the modular configuration of many different options. That’s how you build your own, individual machine – tailored to fit your practical requirements. To make your choice easier, we have put together three practical, user-focused options packs. All other options can be individually combined with the basic machine and the options packs. You will also be able to upgrade your original equipment for a long time to come, wherever the technology permits. As the systems have a lifespan of over 20 years, this is an important factor to consider in your procurement.

EQUIPMENT FOR THE F 45	PAGE	STANDARD EQUIPMENT FOR THE F 45	OPTIONS PACK F 45 I	OPTIONS PACK F 45 II	OPTIONS PACK F 45 III
Motorised rise/fall and tilt control for main saw blade	26/27	■	■	■	■
F 45 screen controls	26/27	■	■	■	■
Eye-level operating panel with clipboard	25, 47				■
Sliding table 3 000 mm	9, 46	■	■	■	■
Rip fence, manual setting with fine adjustment, cutting width 1 000 mm	8	■			
Rip fence, manual adjustment with DIGIT X/digital display, cutting width 1 000 mm	21, 51		■		
Rip fence, motorised adjustment, cutting width 1 000 mm	23, 25, 51			■	■
Crosscut-mitre fence, manual adjustment with length compensation, crosscuts to 3 500 mm	8, 48	■	■	■	■
5.5 kW (7.5 HP) drive rating with three speeds, 3/4/5 000 rpm., manually adjusted	45	■			
VARIO 5.5 kW (7.5 HP) drive rating with infinitely variable speed adjustment between 2 000 and 6 000 rpm.	21, 23, 25, 45		■	■	■
On/off switches on sliding table	21, 23, 47		■	■	
Quick change system for the main saw blade		■	■	■	■
Max. cutting height 200 mm, max. saw blade diameter 550 mm	8, 57	■	■	■	■
840 mm table extension, anodized aluminium	50	■	■	■	■
USB interface for data and program transfer	26/27	■	■	■	■
Machine diagnostics and operating hours counter	26/27	■	■	■	■









## Options pack F 45 I: Combining convenience and safety.

■ The Altendorf F45 can get even easier to use. All you have to do is add a few simple options. This package includes a **VARIO drive**, which can be set to any speed between 2 000 and 6 000 rpm. and thus freely adjusted to suit your materials. This extends the useful life of the saw blades. The rotational speed is displayed digitally on the LCD screen which forms part of the central control unit. The **DIGIT X** digital display on the rip fence increases its precision. The fence is fitted with fine adjustment to ensure setting to within +/- 1/10 mm. Anyone who regularly cuts large panels will learn to love the **on/off switches on the sliding table**. The operating panel on the machine frame has been completely redesigned. The height, tilt angle and speed settings are now displayed even more clearly on a large high-contrast LCD screen.



*This model is fitted with a VARIO drive, a DIGIT X cutting width display on the rip fence and on/off switches on the sliding table itself.*

OPTIONS PACK F 45 I	PAGE	STANDARD EQUIPMENT FOR THE F45	OPTIONS PACK F45 I
Motorised rise/fall and tilt control for main saw blade	26/27	■	■
F45 screen controls on machine frame	26/27	■	■
Sliding table 3 000 mm	9, 46	■	■
Rip fence, manual adjustment with Digit X/digital display, cutting width 1 000 mm	51		■
Crosscut-mitre fence, manual adjustment with length compensation, crosscuts to 3 500 mm	8, 48	■	■
VARIO drive with 5.5 kW (7.5 HP) drive rating with infinitely variable speed adjustment between 2 000 and 6 000 rpm.	45		■
On/off switches on sliding table	47		■
Quick change system for the main saw blade		■	■
Max. cutting height 200 mm, max. saw blade diameter 550 mm	8, 57	■	■
840 mm table extension, anodized aluminium	50	■	■
USB interface for data and program transfer	26/27	■	■
Machine diagnostics and operating hours counter	26/27	■	■

F 45 I





## Options pack F 45 II: Motorised settings save time.

■ **The motorised rip fence** is the highlight of this package. Since the rip fence is controlled directly from the central operating position, there's no need to run round to the other side of the machine and back – so it saves you time. Enter the cutting width using the keypad on the control panel on the machine frame, press the start button, and the rip fence will set itself automatically to within +/- 1/10 mm (absolutely accurate – no need to check again). The **VARIO drive** is also very user-friendly. Using a keypad from the same operating position, you can choose any speed between 2 000 and 6 000 rpm. The LCD screen clearly displays the settings chosen. And just so you can size large panels in greater safety and comfort, **on/off switches** have been fitted to the **sliding table**.

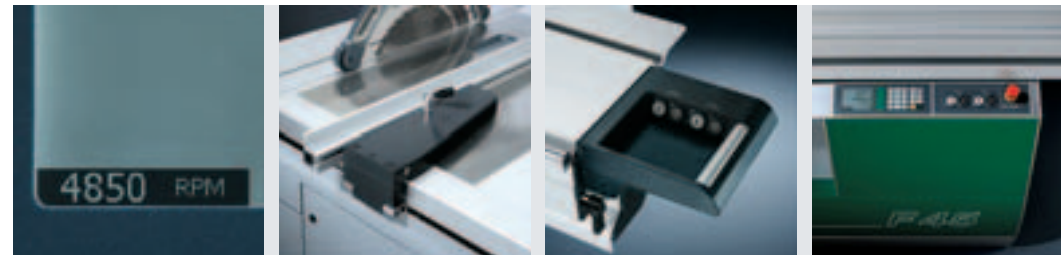

*This model is fitted with a motorised rip fence, the VARIO drive and on/off switches on the sliding table itself.*

OPTIONS PACK F 45 II	PAGE	STANDARD EQUIPMENT FOR THE F45	OPTIONS PACK F 45 II
Motorised rise/fall and tilt control for main saw blade	26/27	■	■
F 45 screen controls on machine frame	26/27	■	■
Sliding table 3 000 mm	9, 46	■	■
Rip fence, motorised adjustment, cutting width 1 000 mm	51		■
Crosscut-mitre fence, manual adjustment with length compensation, crosscuts to 3 500 mm	8, 48	■	■
VARIO drive with 5.5 kW (7.5 HP) drive rating with infinitely variable speed adjustment between 2 000 and 6 000 rpm.	45		■
On/off switches on sliding table	47		■
Quick change system for the main saw blade		■	■
Max. cutting height 200 mm, max. saw blade diameter 550 mm	8, 57	■	■
840 mm table extension, anodized aluminium	50	■	■
USB interface for data and program transfer	26/27	■	■
Machine diagnostics and operating hours counter	26/27	■	■

F 45 II





## Options pack III: See eye to eye with your control panel.

■ The **F45 III** is controlled from an **eye-level operating panel** which allows the user an easy overview of all settings. The panel can be adjusted ergonomically to suit the user, moving both vertically and horizontally. The practical clipboard can be fixed to either the left or the right of the operating panel. The **motorised rip fence** is operated via a keypad from this eye-level panel. The dimensions appear on the large screen. This fence saves you running round to the other side of the machine and back to change the settings. The **VARIO drive** is particularly good for obtaining the optimal cutting speed setting for your material. The infinitely variable speed control is operated via a keypad, and the settings are displayed clearly on the LCD screen. The VARIO drive means there's no need to move the V-belt to change the speed, and the saw blades will no longer need such frequent sharpening.



*An eye-level operating panel allows the user to achieve optimum, ergonomic control of the VARIO drive and the motorised rip fence.*

OPTIONS PACK F45 III	PAGE	STANDARD EQUIPMENT FOR THE F45	OPTIONS PACK F45 III
Motorised rise/fall and tilt control for main saw blade	26/27	■	■
F45 screen controls	26/27	■	■
Eye-level operating panel with clipboard	47		■
Sliding table 3000 mm	9,46	■	■
Rip fence, motorised adjustment, cutting width 1000 mm	51		■
Crosscut-mitre fence, manual adjustment with length compensation, crosscuts to 3500 mm	8,48	■	■
VARIO drive with 5.5 kW (7.5 HP) drive rating with infinitely variable speed adjustment between 2000 and 6000 rpm.	45		■
Quick change system for the main saw blade		■	■
Max. cutting height 200 mm, max. saw blade diameter 550 mm	8,57	■	■
840 mm table extension, anodized aluminium	50	■	■
USB interface for data and program transfer	26/27	■	■
Machine diagnostics and operating hours counter	26/27	■	■

F45 III





## Intelligent control – exact cuts.



■ **The most advanced controls ever offered** in a standard Altendorf are incorporated in this new generation of machinery, resulting in new standards of user-friendliness, simplicity, safety and ergonomics. All settings are easy to read in the large 90 mm LCD display. The green function keys call up the height and tilt of the saw blade, as well as, depending on configuration, scorer, motorised rip fence, and VARIO variable drive speed options. New values are entered using the white input keys.



■ **Control of the axes** and other functions is possible either via numerical input or via continuous precision control using the +/- keys. The control unit can store up to 20 set-ups, making it easier to repeat a cut and helping to eliminate user errors. A touch of a button calls up the previous set-up from the memory, and another puts it into effect. When the saw blade tilts, the cutting height is corrected automatically.



■ **For safety's sake**, the F45 has a self-diagnosis facility which displays potential faults immediately on the display in detail. The USB interface is also new: it enables you to store machine data on a USB stick. It also provides quick and easy access for software updates.



**CONTROL FUNCTIONS AVAILABLE:**

- Input of height and tilt parameters for main saw blade via keypad (CNC controlled)
- Digital cutting height display
- Digital tilt angle display
- Digital rotational speed display
- Continuous precision control using +/- keys
- Easy axis calibration
- Machine self-diagnosis
- Operating hours counter
- USB interface
- Last set-up recall from the buffer memory
- Program menu with language selection, switching between mm and inches and 20 storable set-ups

**Optional:**

- Motorised rip fence control incorporating the following functions: grooving, incremental dimensions and bevel rip
- Motorised adjustment of the scoring unit
- Infinitely variable speed adjustment (VARIO)



THE F45

- Equipment Overview
- F45 ELMO III
- F45 ELMO IV

# ELMO

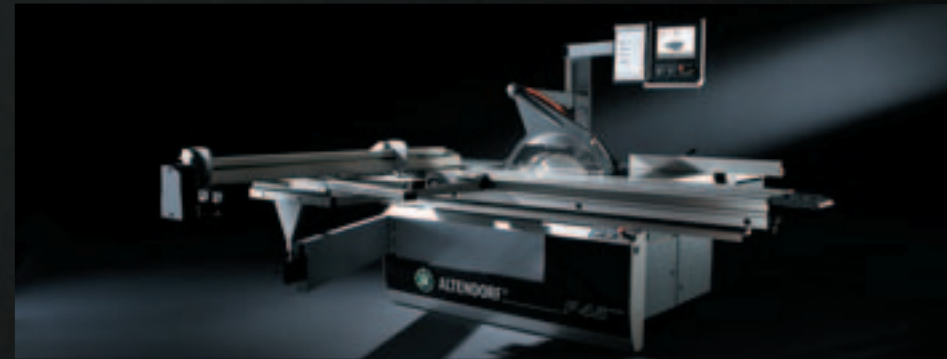

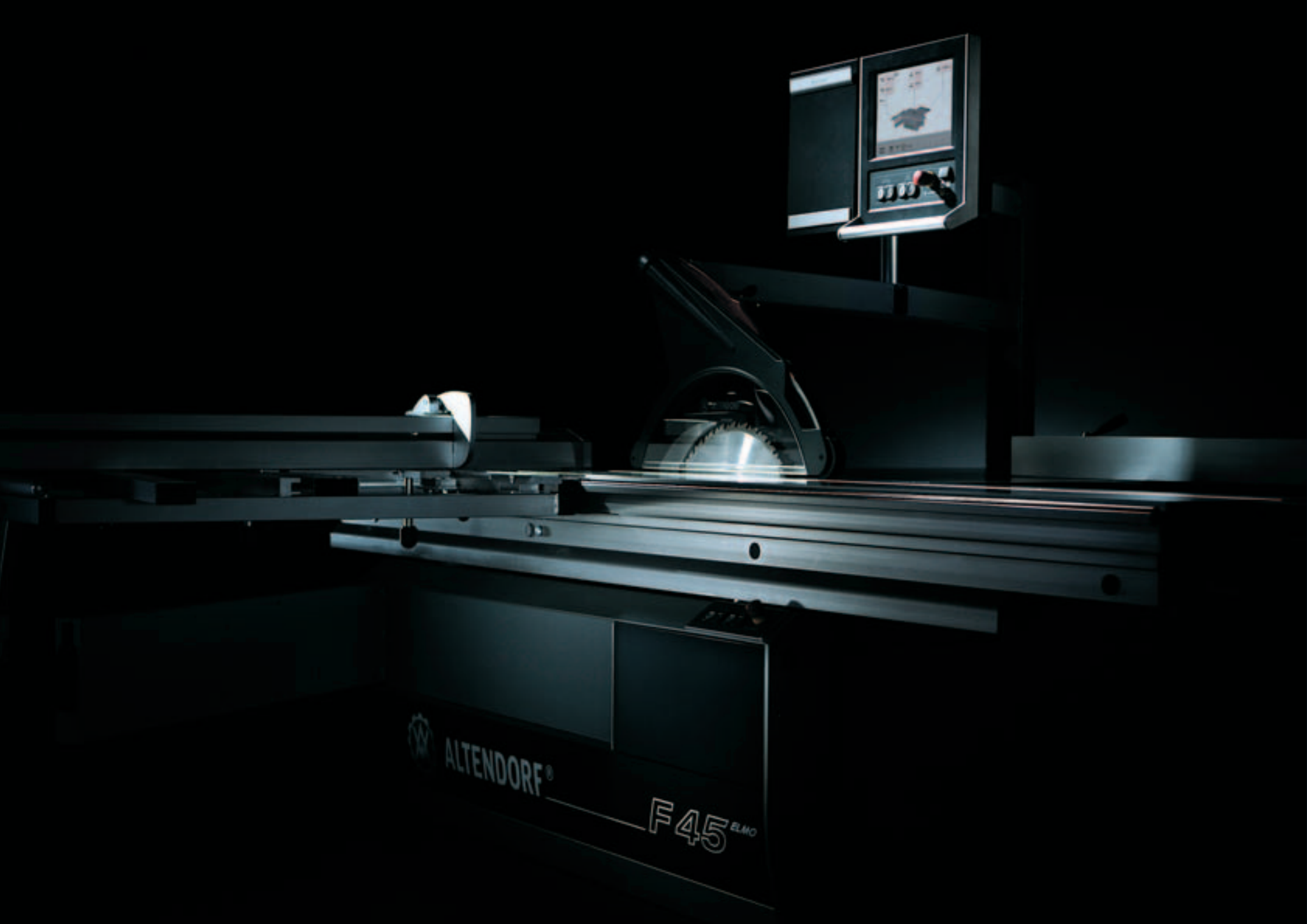

 ALTENDORF®

F45<sup>ELMO</sup>











Eye-level operating panel

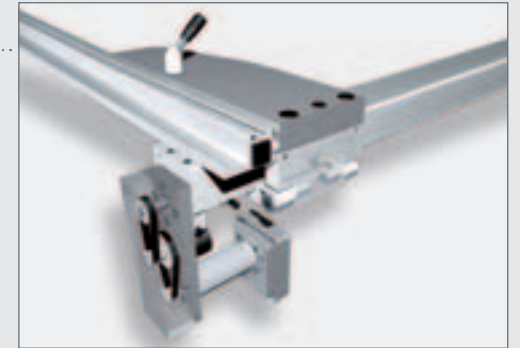

Motorised rip fence

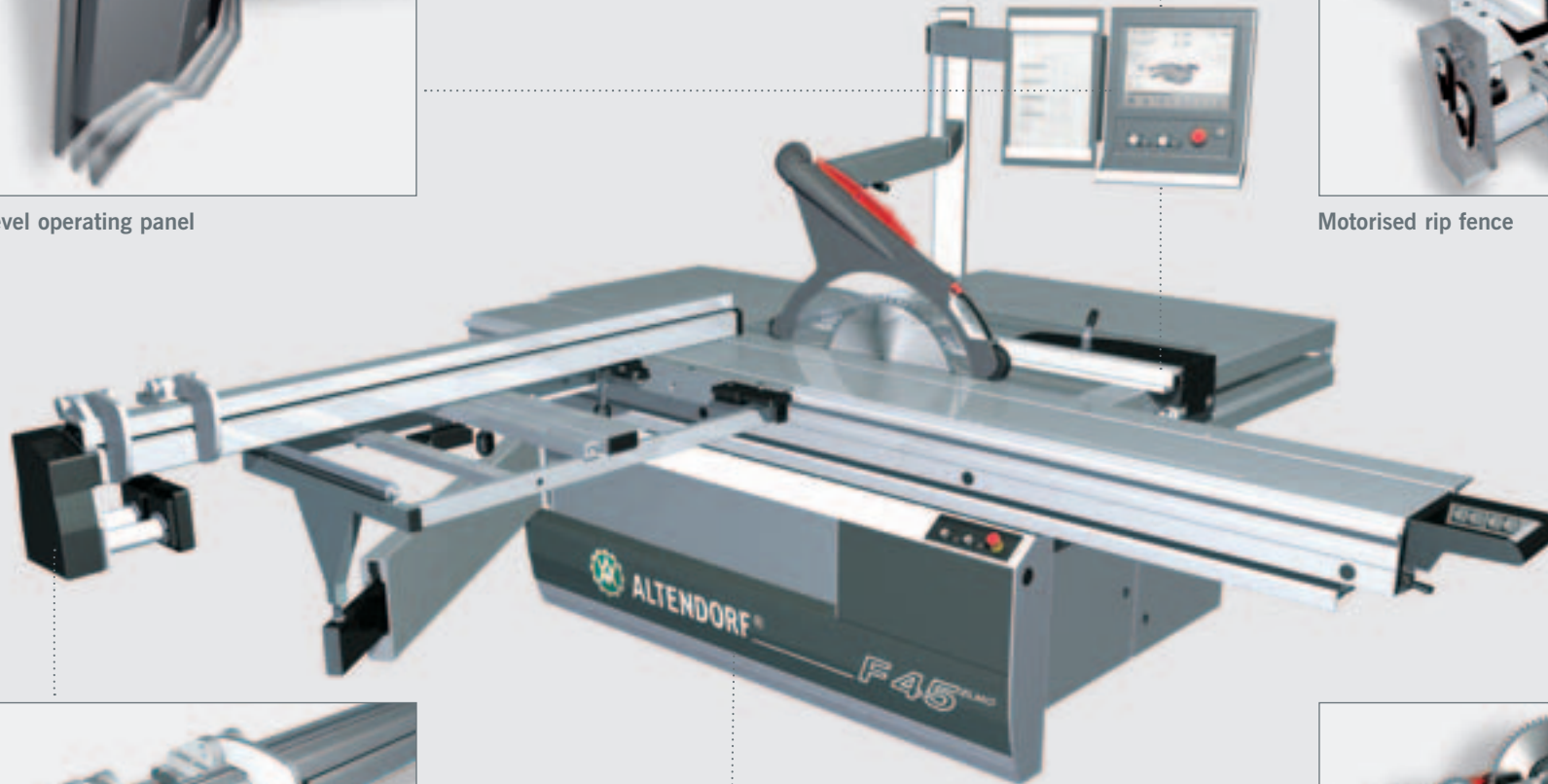

Motorised crosscut-mitre fence

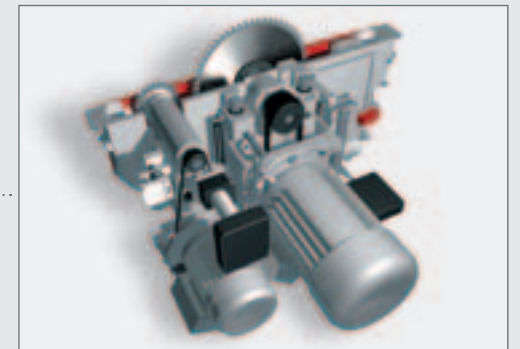

Saw unit



## The F 45 ELMO – An intelligent modular system.

■ **The new F 45 ELMO** has been fundamentally redesigned. The result is a high-tech modular system, which handles even the most challenging technical requirements of the saw user. The low-reflection 12" colour LCD display with touch screen functionality is **new**. This display method makes for straightforward operation through a self-explanatory, graphics-oriented approach to control. The display shows 90% of the applications, thus cutting down on time spent navigating. The USB port for data exchange and backup is also **new**. A further innovation is the crosscut-mitre fence on the F 45 ELMO IV, which can be adjusted to any angle between 0 and 47° and has integral length compensation. The F 45 ELMO legend is reborn!

		F 45 ELMO III	F 45 ELMO IV
<b>EQUIPMENT FOR THE F 45 ELMO</b>	<b>PAGE</b>		
Motorised rise/fall and tilt control for main saw blade	40, 41	■	■
F 45 ELMO screen controls with touch screen	37, 39, 40	■	■
Eye-level operating panel with clipboard	37, 39, 40	■	■
Sliding table 3 000 mm	9, 46	■	■
Rip fence, motorised adjustment, cutting width 1 000 mm	37, 39, 40, 51	■	■
Crosscut-mitre fence, manual adjustment with length compensation, crosscuts to 3 500 mm	8, 37, 48	■	
Crosscut-mitre fence, motorised adjustment of flip stops, manual angle adjustment with length compensation, crosscuts to 3 500 mm	39		■
VARIO drive with 5.5 kW (7.5 HP) drive rating and infinitely variable speed adjustment between 2 000 and 6 000 rpm.	37, 39, 45	■	■
Preparation for scoring unit retrofit	37, 39, 44	■	■
Quick change system for the main saw blade		■	■
Max. cutting height 200 mm, max. saw blade diameter 550 mm	8, 57	■	■
840 mm table extension, anodized aluminium	50	■	■
USB interface for data and program transfer	40	■	■
Machine diagnostics and operating hours counter	40	■	■





## F 45 ELMO III: Diversity and functionality.

■ The **F 45 ELMO III** offers a diverse range of practical application programs to simplify the execution of both daily operations and special cutting requirements. Operation is via a **12" touch screen**. Just key in the dimensions, press the start key and the **motorised rip fence** will move, at 250 mm/sec., to precisely the set value within a tolerance of +/- 1/10 mm. The infinitely variable 2 000–6 000 rpm. **VARIO drive** rounds off the package of quality and efficiency.



*The F 45 ELMO III is ideal, with a large 12" touch screen to run the whole machine and its comprehensive range of programs.*

EQUIPMENT FOR THE F 45 ELMO III	PAGE	STANDARD EQUIPMENT FOR THE F 45	F 45 ELMO III
Motorised rise/fall and tilt control for main saw blade	40, 41	■	■
F 45 ELMO screen controls with touch screen	40		■
Eye-level operating panel with clipboard	40		■
Sliding table 3 000 mm	9, 46	■	■
Rip fence, motorised adjustment, cutting width 1 000 mm	40, 51		■
Crosscut-mitre fence, manual adjustment with length compensation, crosscuts to 3 500 mm	8, 48	■	■
VARIO drive with 5.5 kW (7.5 HP) drive rating and infinitely variable speed adjustment between 2 000 and 6 000 rpm.	45		■
Preparation for scoring unit retrofit	44		■
Quick change system for the main saw blade		■	■
Max. cutting height 200 mm, max. saw blade diameter 550 mm	8, 57	■	■
840 mm table extension, anodized aluminium	50	■	■
USB interface for data and program transfer	40	■	■
Machine diagnostics and operating hours counter	40	■	■

F 45 ELMO III









## F 45 ELMO IV: High-level CNC technology.

■ The **F 45 ELMO IV** is the pinnacle of the Altendorf sliding table saw range. It has four axes – height, tilt, **rip fence and crosscut-mitre fence**. These can be controlled via the ELMO 12" touch screen controls and the comprehensive range of programs. The display depicts 90 % of all applications. And it has new features: the **crosscut-mitre fence can be manually adjusted to the required angle, with automatic length compensation of the two motorised flip stops**. Switching between front and rear positions on the cross slide can be achieved without lifting the fence. The mitre angle can be adjusted to anywhere between 0 and 47° in either position, and is displayed in digital form on the screen, to an accuracy of 1/100°. The **VARIO drive** for infinitely variable speed adjustment (between 2 000 and 6 000 rpm.) forms an integral part of the machine. And the interface package option means the F 45 ELMO can be networked.

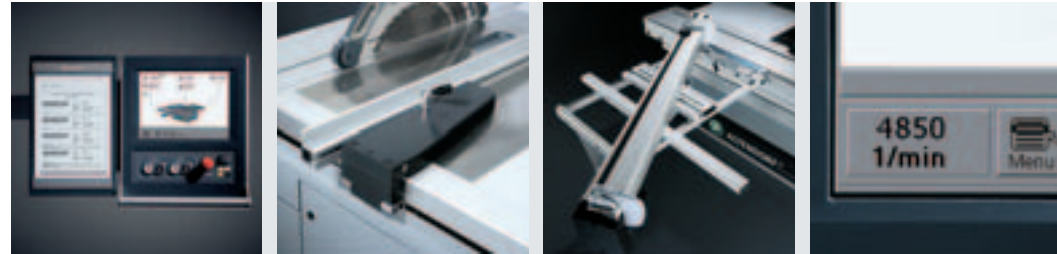

*The F 45 ELMO IV is simplicity itself to work with: The 12" touch screen controls all processes, the rip and crosscut-mitre fence are both motorised, and the VARIO drive provides infinitely variable speed adjustment.*

EQUIPMENT FOR THE F 45 ELMO IV	PAGE	STANDARD EQUIPMENT FOR THE F-45	F 45 ELMO IV
Motorised rise/fall and tilt control for main saw blade	40, 41	■	■
F 45 ELMO screen controls with touch screen	40		■
Eye-level operating panel with clipboard	40		■
Sliding table 3 000 mm	9, 46	■	■
Rip fence, motorised adjustment, cutting width 1 000 mm	51		■
Crosscut-mitre fence, motorised adjustment of flip stops, manual angle adjustment with length compensation, crosscuts to 3 500 mm	39		■
VARIO drive with 5.5 kW (7.5 HP) drive rating with infinitely variable speed adjustment between 2 000 and 6 000 rpm.	45		■
Preparation for scoring unit retrofit	44		■
Quick change system for the main saw blade		■	■
Max. cutting height 200 mm, max. saw blade diameter 550 mm	8, 57	■	■
840 mm table extension, anodized aluminium	50	■	■
USB interface for data and program transfer	40	■	■
Machine diagnostics and operating hours counter	40	■	■

F 45 ELMO IV



## Simple controls for efficient cutting.



■ **The new F45 ELMO touch screen control** reacts to light pressure from the user's fingers, and its large 12" size makes it easy to read. At any one time, only the information required to perform the next operating step is displayed. This means targeted work and fast, error free entry.

**A swift glance at the screen** shows the position of the fences and other settings. In the centre of the screen is an icon for the machine, while the axis positions are shown grouped around the machine to give an easy overview. Touching a parameter displayed on the screen opens the window for entering values. Positioning can then begin with a touch of the start key. Self-explanatory symbols provide a reliable guide to the comprehensive range of functions available. The practical help function reacts to unexpected inputs and shows means of troubleshooting.

**Even difficult cuts** are made easier and more exact than ever. The F45 ELMO IV's crosscut-mitre fence can be adjusted manually to any angle between 0 and 47°. The new controls measure the mitre angle to within  $\pm 1/100^\circ$ , calculate the length compensation and automatically adjust the flip stops to the correct setting. This means you can make mitre cuts at acute or obtuse angles, and cut compound mitres in a single operation.

**For speed** when it comes to frequently-used functions, the lower part of the screen has a toolbar giving direct access without having to trawl through the menu. In order to optimize the individual steps needed in your particular work, some of these fields can be customized (desktop function). All the other functions are arranged in three easily identifiable groups on the main menu, which you can access via the menu key. Control unit software updates can be loaded using a USB stick.



### APPLICATIONS:

- Incremental dimensions
- Grooving
- Bevel rip for accurate angle ripping of long, narrow work-pieces
- Compound mitres
- Mitre joints between pieces of different widths
- Cutting sequences
- Geometric shapes
- Measurement to the stops on the crosscut-mitre fence as a function of the blade angle and the thickness of the material



## Combining IT with the F 45 ELMO.

### F 45 ELMO CONTROL FUNCTIONS AVAILABLE:

- Motorised rise and fall and tilt of the saw blade
- Motorised rip fence setting
- F 45 ELMO IV: Motorised setting of the stops on the crosscut-mitre fence
  - Automatic length compensation for the stops on the crosscut-mitre fence
  - Mitre angle displayed to within  $1/100^\circ$ , range:  $0-47^\circ$
  - Two independently adjustable flip stops
- Automatic cutting width correction on motorised fences when saw blade tilted
- Traverse speed of axes 250 mm/sec.
- Stores up to 600 set-ups
- Machine diagnostics
- Job time recording and operating hour counter
- Calculator function, with results transferred to the relevant axis
- Interface for connecting to a PC (optional)
- Tool management
- Options for basic settings: Choice of language, switch between mm and inches, data import/export, technician level
- Infinitely variable speed selection (VARIO)

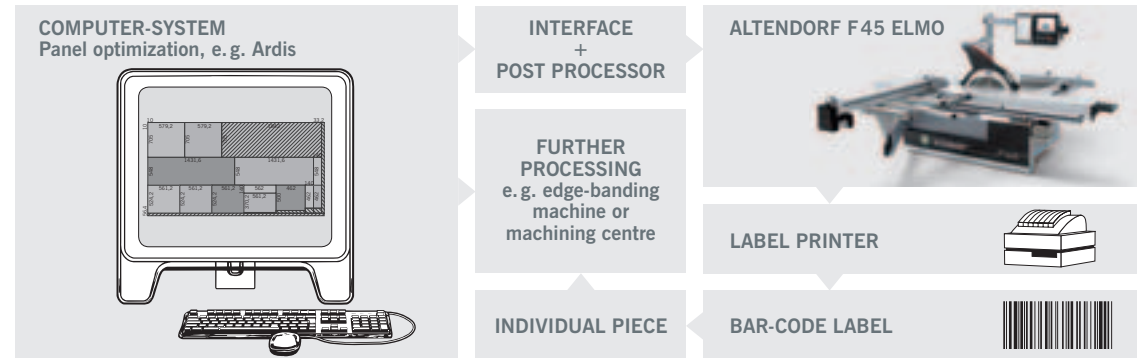

#### ■ Connecting to your network:

The interface package option means the F45 ELMO can be networked. This network connection means the machine can communicate online with your production planning department using all the latest software operating systems (requires CP out interface).

#### ■ Activities using the F 45 ELMO combined with your IT system:

Cutting sequences can be read in easily by scanning the workpieces using a barcode reader. For every new cutting sequence, the user simply presses the start key and the axes move into position. This results in error-free finished pieces.

■ **Label printing:** A label is automatically generated for each finished workpiece. This label contains information for subsequent processing (e.g. by an edge-banding machine or machining centre).







## The right configuration for the materials you cut.



■ **RAPIDO scoring tool:** A scorer prevents chipping out on the underside of laminated panels. The RAPIDO scoring system makes it easier and quicker to adjust the cutting width to match that of the main blade. How quick? About three minutes, max! Compared to working with shims, where you have to take the blade off the machine to alter its width, the RAPIDO saves up to 30 minutes time, as the blade stays on the machine during adjustment. Adjustment is continuous so the RAPIDO can be fine-tuned to match any main blade. Adjustment range: 2.8–3.8 mm.

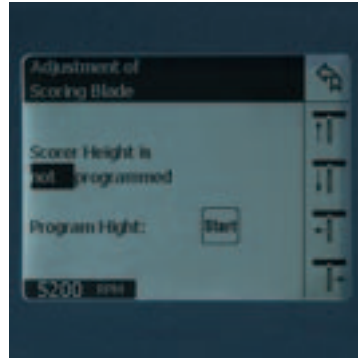

■ **Motorised scorer adjustment:** The vertical and lateral settings of the Altendorf scoring saw are motorised and can be adjusted while the saw is running. Simple menu guidance on the display positions the scorer within seconds. The last scoring height used can be stored. When the scoring blade is switched on, the scorer moves to the height stored. When either the main or scoring blade is switched off, the scorer moves back under the table.



■ **New: RAPIDO Plus.** This three-axis scoring system offers motorised positioning not only of the vertical and lateral settings, but also of the cutting width. All settings can be activated via the keypad while the machine is running, and are shown on screen. Settings are stored, then called up again the next time the machine is switched on. Changing saw blades is quick, easy and safe. The first set of saw blades is supplied with your machine.



■ **VARIO drive:** VARIO offers infinitely variable rotational speed setting, so the saw shaft RPM can be set to achieve the exact optimum cutting speed for whichever material you use. There are many questions relating to cutting wood, plastic and non-ferrous metals which conventional three-phase motors cannot answer. The VARIO drive is Altendorf's response to these. Infinitely variable speed adjustment between 2000 and 6000 rpm. means that, compared to three-phase motors with nominal power of 11 kW, there is no loss of power in the key 2000–4300 rpm. speed range. The average torque on the saw, throughout the speed range, is 40 Nm. The VARIO is very user-friendly: frequently-used speeds can be stored and recalled. This means it is possible to adapt the rotational and cutting speeds to suit the application and the geometry of the workpiece and thus achieve the best results.

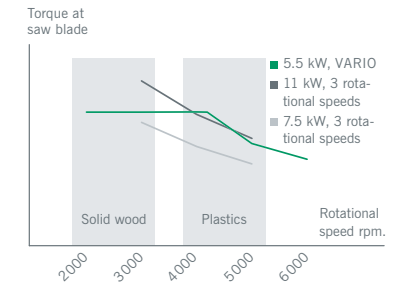





## Silence is power.

■ We recommend the VARIO drive as the best way of achieving optimum results for different materials by means of infinitely variable speed adjustment between 2 000 and 6 000 rpm. The drive will save you saw blade maintenance and procurement costs, as well as setup time. The drive can be adjusted while the motor is running. Frequently-used speeds can be stored and recalled.

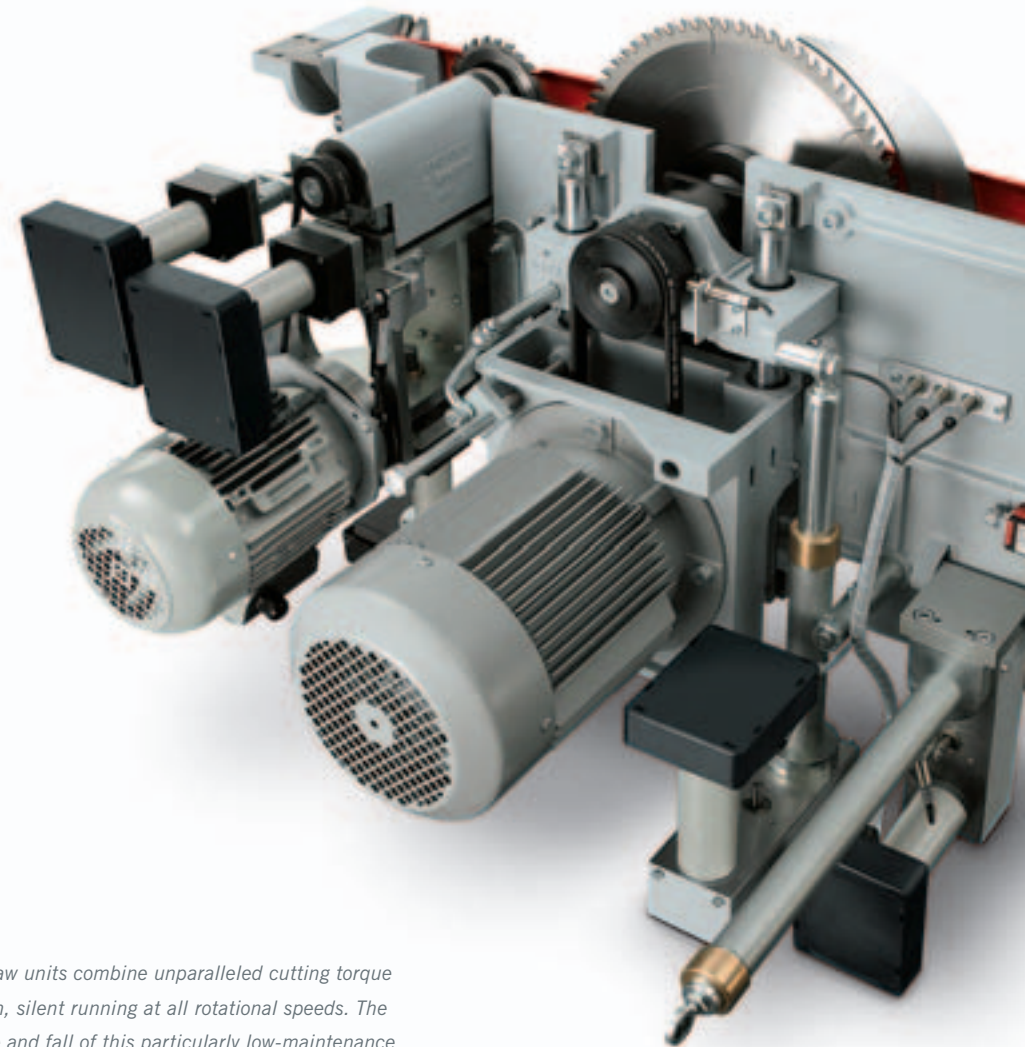

	STANDARD EQUIP- MENT FOR THE F 45	OPTIONS PACKS F 45 I – III	F 45 ELMO III AND IV
<b>DRIVE RATING AND ROTATIONAL SPEED</b>			
<b>5,5 kW (7.5 HP)</b>			
· three-speeds, manually adjusted 3/4/5 000 rpm.	■		
· VARIO/infinitely variable speed adjustment 2 000 – 6 000 rpm.	□	■	■
<b>7.5 kW (10 HP)</b>			
· three-speeds, manually adjusted 3/4/5 000 rpm.	□	□	□
<b>11 kW (15 HP)</b>			
· three-speeds, manually adjusted 3/4/5 000 rpm.	□	□	□

- Supplied as standard
- Optional extra

*Altendorf saw units combine unparalleled cutting torque with smooth, silent running at all rotational speeds. The vertical rise and fall of this particularly low-maintenance saw unit uses high-precision maintenance free linear motion guide bearings.*



## Renowned for smooth running and precision.

■ **Sliding table:** The Altendorf sliding table is renowned for its smooth, precise running. The large double rollers guide the moving table with absolute precision between the top and bottom hardened steel guide bars. The table requires little force to move. The sliding table will work for decades without any complications, requiring little maintenance and no lubrication. The hollow multi-chamber design gives great torsion resistance and rigidity.

SLIDING TABLE	F45
Table length 2 250 mm	<input type="checkbox"/>
Table length 3 000 mm	<input checked="" type="checkbox"/>
Table length 3 200 mm	<input type="checkbox"/>
Table length 3 400 mm	<input type="checkbox"/>
Table length 3 800 mm	<input type="checkbox"/>
Table length 4 300 mm	<input type="checkbox"/>
Table length 5 000 mm	<input type="checkbox"/>

■ Supplied as standard

Optional extra



■ **On/off switches on sliding table:** The practical option. The on/off switches are always right where you need them, at the end of the sliding table. The four keys switch both the main and scoring blades on and off. This option allows you to load a large workpiece before switching the machine on, thus improving safety and convenience. The keys can be operated without you having to switch specially between the machine operating panel and the sliding table switches.



■ **New: Eye-level operating panel.** The eye-level operating panel has been designed to suit both left- and right-handed operators. The optional clipboard can be fitted to either side of the screen. A new type of positioning joint ensures the screen can be adjusted both horizontally and vertically to suit the user.

**OTHER USEFUL FEATURES INCLUDE:**

- A low-reflection screen
- A large, easily readable display
- Ergonomically designed operating controls
- Colour-coded function areas
- Multilingual software
- Data transfer (e.g. software updates) and backup via USB port



■ **TIP-SERVO-DRIVE:** Electric servo assisted drive for the sliding table. This unique optional extra is designed to take the strain off the operator's body, especially the back. The motorised drive of the sliding table makes it supremely easy to move even the heaviest of workpieces back and forward during cutting, while the electronic sensor control handle responds to the slightest touch (max. 1 kp). You can move the sliding table along the entire length of the cut in both directions of travel with full servo support, and you can vary the speed as you wish by varying your hand pressure. The control handle can be positioned anywhere on the sliding table. The result: you can walk upright and fully relaxed during the entire cutting operation. TIP-SERVO-DRIVE is not available for model F45 ELMO IV or in conjunction with on/off switches on sliding table.



## Improved crosscutting and mitre cutting.



■ **DIGIT L crosscut-mitre fence:**

This fence has a digital length display with fine adjustment allowing precise setting to within  $\pm 1/10$  mm over a range from 150–3200 mm. The stop being displayed changes at the touch of a button. Calibration, e.g. after changing saw blades, is quick and easy, all three stop positions being calibrated in a single operation. The electronics are on permanently so they can be used at any time. The mitre, with length compensation, is set using scales.



■ **DIGIT LD crosscut-mitre**

**fence:** This fence is the same as the DIGIT L, but with this option the angle is also displayed digitally. It can be set to within  $\pm 1/100^\circ$ . The length is calculated automatically according to the mitre. This means there's no need for test cuts.



**Crosscut-mitre fence:** This fence simplifies crosscuts and mitre cuts because it does both. Switching between front and rear positions on the cross slide can be achieved without lifting the fence. In either position, the mitre angle can be adjusted to anywhere between 0 and  $49^\circ$  using a scale. Even when the fence is angled, a large supporting surface area is available for workpieces.



When cutting mitres, length compensation means measurements to the stops are accurate whatever the angle. Simply slide the fence to the desired angle, line up the pointer with the same angle on the length compensation scale, then set the flip stop to the length required.

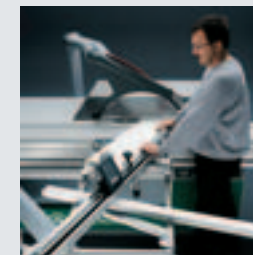

The **DIGIT LD** version of the crosscut-mitre fence offers digital display of both the angle and the distance to the flip stops to an accuracy of  $\pm 1/10$  mm. Length compensation is automatic, there's no additional scale. This makes it child's play to reproduce workpiece lengths as a function of the cutting angle, without the need for extra calculation or special gauges.

**PRACTICAL TIPS:**  
**CROSSCUT-MITRE FENCE**





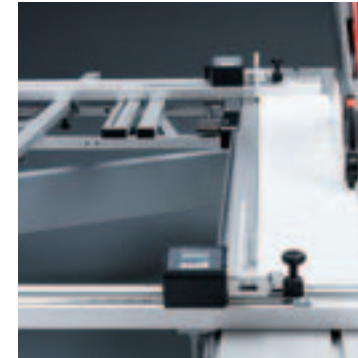

■ **DUPLEX double-sided mitre fence:** DUPLEX fences make it possible to cut any angle between 0 and 90° very quickly and exactly. At 45°, the mitre can be cut on both sides of the workpiece without having to adjust the fence. The dimensions are set using a magnifying glass, measuring scale and length compensation scale. All varieties of DUPLEX can be positioned anywhere along the length of the sliding table.

■ **DUPLEX D:** The DUPLEX D functions in exactly the same way as the standard DUPLEX with the addition of a digital angle display which operates to an accuracy of within 1/100°.

■ **DUPLEX DD:** An exclusive Altendorf development, the DUPLEX DD has been patented worldwide. The high precision DUPLEX DD electronics incorporate automatic length compensation and calculate the distance to the stops as a function of the angle on both sides of the fence and display both figures digitally. Checking of measurements, complicated calculations and test cuts are all unnecessary.

■ **PALIN D:** This fence, used in conjunction with the flip stops on the crosscut fence, is ideal for ripping long narrow workpieces to precise width on the sliding table side of the saw blade. The PALIN D is equipped with a digital measuring unit with fine adjustment. It's ideal for cutting long mitres with the saw blade at an angle. The stop adjusts to 900 mm wide. It is also available in an analogue version, with a measuring scale which can be read with a magnifying glass. The photo shows the DIGIT L crosscut-mitre fence option.

DOUBLE-SIDED MITRE FENCES	CROSSCUT STOPS TO
DUPLEX, settings via measuring scale with longer fence	1 350 mm 2 150 mm
DUPLEX D, with digital angle setting with longer fence	1 350 mm 2 150 mm
DUPLEX DD, with digital angle and length setting with longer fence	1 350 mm 2 150 mm





## Workpieces securely supported.

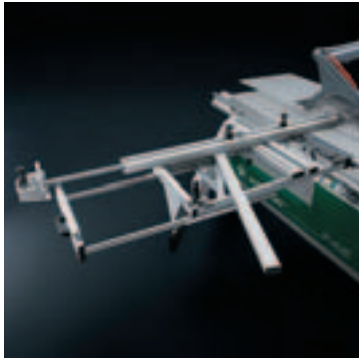

■ **Cross slide extension:** Can be pulled out by up to 700 mm.



■ **Additional cross slide:** For particularly large workpieces weighing up to 250 kg. The flip stops drop away under the support area of the cross slide.

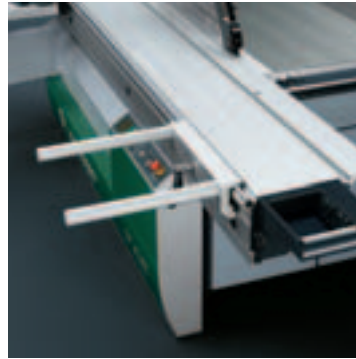

■ **STEG – second support on the sliding table:** Enlarges support area (width: 400 mm) for wider workpieces.



■ **Infeed support table:** An additional workpiece support for long, narrow workpieces. Positioned in front of the machine table, it can be swung away and lowered.

TABLE EXTENSIONS		CUTTING WIDTHS TO RIP FENCE	
(positioned behind the machine table), anodized aluminium		Table extension, anodized aluminium	
	F45		F45
840 mm	■	800 mm	□
1 200 mm	□	1 000 mm	■
1 600 mm	□	1 300 mm	□
2 000 mm	□	1 600 mm	□

■ Supplied as standard

□ Optional extra



**Cross slide extension:**

*The cross slide extension can be used as an additional supporting surface when crosscutting large or long workpieces.*

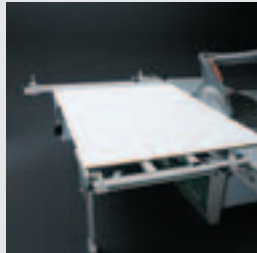

**Additional cross slide:**

*The additional cross slide supports large and/or heavy panels, thus ensuring precise cutting.*

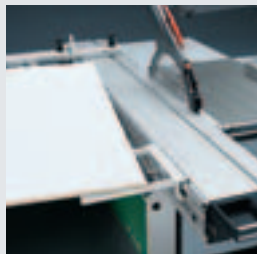

**STEG:**

*The STEG second support makes the user's job easier when it comes to sizing large panels.*



**Infeed support table:**

*The infeed support table is useful when trimming long, narrow workpieces.*

## Precision cutting to the right of the saw blade.



■ **DIGIT X:** A digital cutting width display for the rip fence with manual fine adjustment. This electronic measuring system guarantees rapid, precise adjustment of the rip fence. DIGIT X also offers repeat accuracy: the fence can be moved and then returned to exactly where it was previously. The system is immune to both wear and dust. Dimensions are corrected automatically when the fence is changed from the upright or the flat position.

■ **Motorised rip fence:** The motorised rip fence has a traverse speed of 250 mm/sec. and an accuracy of +/- 1/10 mm. The high precision five-point recirculating ball spindle system needs little maintenance and, along with the motor, is well protected by its integration into the aluminium profile. There are no loose cables to get in the way. The fence automatically recognizes the position it's in, especially when it reaches the danger area around the saw blade. It has an emergency cut-out to prevent the risk of crushing. The dimensions are corrected automatically when the fence is changed from the upright or the flat position, or the saw blade tilted.

**PRACTICAL TIPS:  
LAYING WORKPIECES OUT.**





## Greater safety, greater convenience.



■ **Quick-action pneumatic clamp:** Ensures the workpiece is securely supported on the sliding table. Activated by radio remote control, the quick-action clamp exerts a clamping force of up to 1 000 N. The workpiece is held rock solid against the crosscut fence. Workpieces up to 90 mm or between 80 and 170 mm thick can be attached in this way. Available with one or two clamping units.



■ **Manual quick-action clamp:** This is the alternative to the pneumatic clamp. The manual clamp can be easily positioned on the sliding table and is equally easy to fix. The workpiece is then firmly secured on the table and held firmly against the crosscut fence. This provides extra safety at very little extra cost.

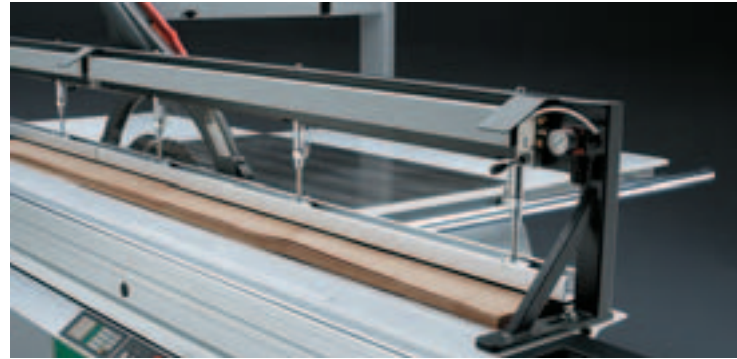

■ **Pneumatic pressure beam:** Comes in two pieces, which can be controlled separately. This secures workpieces up to 80 mm thick. It is especially useful for long, thin materials such as veneer.

### PNEUMATIC PRESSURE BEAM

Clamping height 80 mm, pneumatic connection to be provided by customer (6 bar)

TABLE LENGTH	CLAMPING LENGTH
2 250 mm	1 975 mm
3 000 mm	2 725 mm
3 200 mm	2 925 mm
3 400 mm	3 125 mm
3 800 mm	3 525 mm



■ **Laser cutting line marker:** Shows the cutting line – up to around 5000 mm beam length – which is useful when trimming or cutting marked jobs, e.g. steps. Saves time and materials.



■ **Coolant spray device:** A spray device is recommended for plastics with a low melting point and for certain light metal alloys. Thousands of Altendorf sliding table saws have already been at work for years in the plastics and metal processing industries. An Altendorf will cut non-ferrous metals and plastics cleanly, with sharp contours, to within a tenth of a millimetre.



*Perfect cutting results, and not just for wood: With the F45 and F45 ELMO, you can handle a wide range of materials apart from wood, for example non-ferrous metals and various plastics. And there is no better evidence than the thousands of Altendorf sliding table saws in use with in metal- and plastics-processing businesses right across the world.*









■ **An Altendorf needs space:** Your new Altendorf will have a long life of precision cutting and high productivity. But you will need to give it room to develop its full potential. The key parameters for the amount of space required are as follows: On the left is the crosscut fence, which can extend up to 3650 mm when the outer flip stop is at its maximum. The space required on the right-hand side will be determined by your decision regarding cutting width to the rip fence (between 800 and 1600 mm). Thirdly, the length of the sliding table will determine the space you will need to leave clear to accommodate its travel to the front and back of the machine.

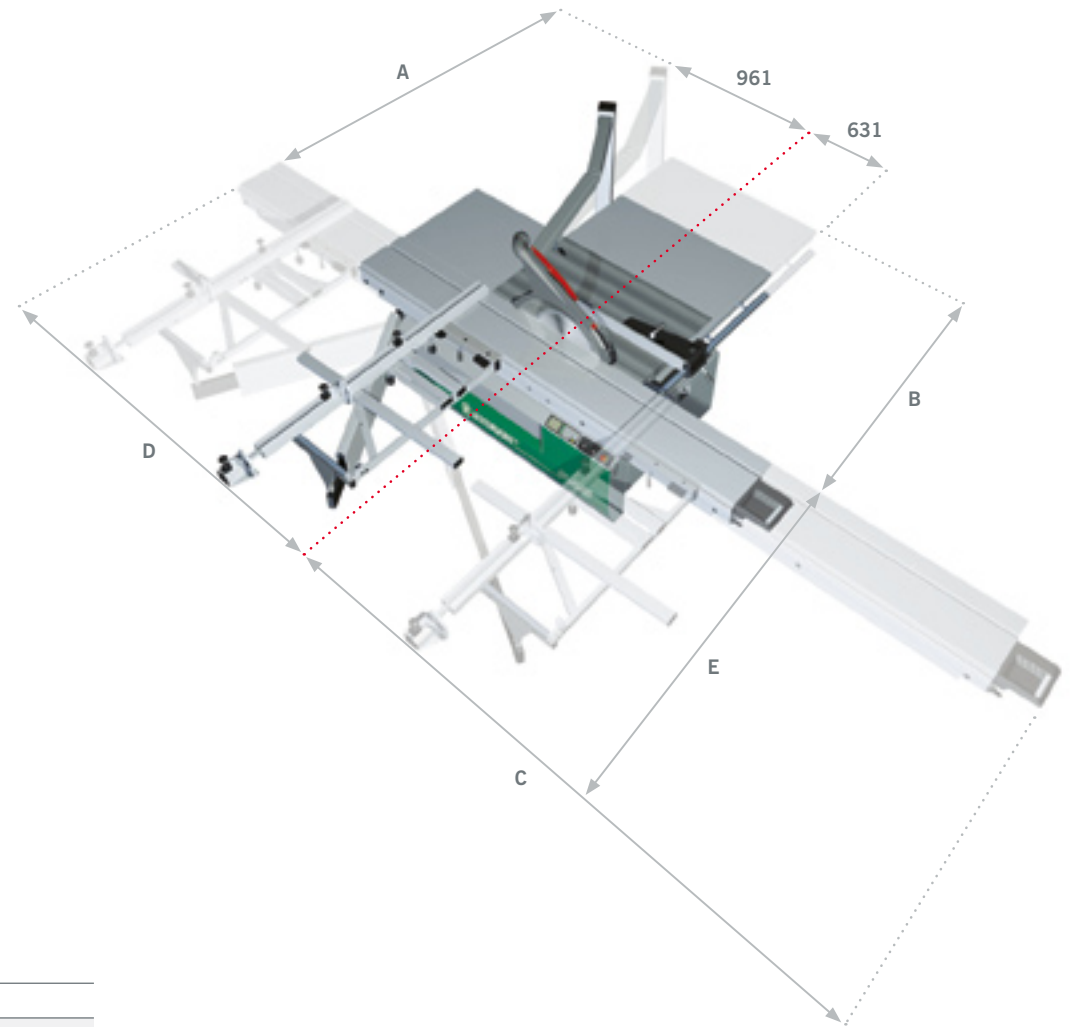

## Space requirements

### YOUR F45'S SPACE REQUIREMENTS ARE AS BELOW:

<b>A</b>	Cutting width + 330 mm Cutting width + 580 mm	with manual adjustment for F45 ELMO III und F45 ELMO IV
<b>B</b>	Cutting width + 310 mm Cutting width + 400 mm	with manual adjustment and DIGIT X for F45 ELMO III and F45 ELMO IV
<b>C</b>	Sliding table length + 360 mm	
<b>D</b>	Sliding table length + 290 mm	
<b>E</b>	Crosscut-mitre fence Crosscut-mitre fence with DIGIT L Crosscut-mitre fence F45 ELMO IV Crosscut fence up to 3200 mm	1970 – max. 3635 mm 1970 – max. 3335 mm 2100 – max. 3650 mm 1445 – max. 3330 mm
Machine weight 870 kg – 1170 kg depending on configuration		
Table height 910 mm		



All machines illustrated are CE models.

Some illustrations of machines depict special equipment which is not included in the basic price.

Right of technical modification reserved.

© ALTENDORF® 2006

Order number K 9690.0426

03/2007



## Technical information.

### SLIDING TABLE CUTTING LENGTHS

Maximum cutting lengths when using clamping shoe or crosscut-mitre fence. Not in conjunction with crosscut fence, stops to 2 500 mm.

Table length (mm)	2 250	3 000	3 200	3 400	3 800	4 300	5 000
Cutting length (mm) with or without scoring saw blade	2 155	2 905	3 105	3 305	3 705	3 870 (4 205*)	3 870 (4 905*)
<b>TIP-SERVO-DRIVE</b>							
Cutting length (mm) without scoring saw blade	1 840	2 590	2 790	2 990	3 390	3 870	3 870 (4 570*)
Cutting length (mm) with scoring saw blade	1 725	2 475	2 675	2 875	3 275	3 775	3 775 (4 475*)

\* Possible cutting lengths without use of the crosscut fence and cross slide.

Cutting lengths refer to mechanical travel, i. e. from end stop to end stop on the sliding table.

### CUTTING HEIGHTS

Saw blade diameter, in mm	250	300	315	350	400	450 <sup>1)</sup>	500 <sup>1)</sup>	550 <sup>2)</sup>
Cutting heights, vertical, in mm	0–50	0–75	0–82	0–100	0–125 <sup>3)</sup>	10–150	35–175	90–200
Cutting heights at 45°, in mm	0–33	0–50	0–56	0–68	0–86	4–103	22–121	61–139

<sup>1)</sup> If a scoring unit is fitted, the scoring saw blade, including front and back flanges, or RAPIDO must be removed.

<sup>2)</sup> Only on saws without a scoring unit.

<sup>3)</sup> Only on saws with a scoring unit.





## The home of the saw.

■ **Over the course of its history**, Altendorf has only really moved homes once, namely in 1919, when Wilhelm Altendorf relocated operations from Berlin to his home town of Minden. Altendorf did move on one other occasion, but this was within the town boundaries. Since then, the existing production and administrative facilities have been remodeled and extended several times. The company's anniversary year saw the most notable expansion, with the inauguration of the new training and sales building in March 2006. Within these walls, Altendorf's leading-edge industrial design documents the company's determination and ability to face future challenges. The ground floor accommodates not only exhibition space featuring the latest Altendorf machines, but also a museum section devoted to the development of the "Altendorf System" sliding table saw. The layout is arranged in such a way that every visitor passes through this large exhibition area upon entering the building. The upper part of the building houses the company's training school, which is accommodated in tuition rooms equipped with the latest facilities. The school instructs more than 1 000 people in the use of our saws every year.

Minden remains the home of the world's most famous sliding table saw. Here is where we devise our new solutions, develop innovations and plan our appearances on the international stage. Minden is where the heart of Altendorf lies, even if we now operate several subsidiary companies around the world which either market our products or manufacture other regional models. Our subsidiary in Qinhuangdao (China), for example, has been doing this with success since 1995.





Wilhelm Altendorf GmbH & Co. KG · Wettinerallee 43/45 · 32429 Minden · Germany  
Phone +49 571 9550-0 · Fax +49 571 9550-111 · [sales@altendorf.de](mailto:sales@altendorf.de) · [www.altendorf.com](http://www.altendorf.com)