

# “XL”

## Presse idrauliche a caldo



Hydraulic hot presses

# XL

Heizplattenpressen

# XL



**Italpresse S.p.A.**  
Presse idrauliche



# Il nuovo standard di pressa a caldo

**XL:** sets the new standards for a hot press  
**XL:** der neue standard fuer heizplattenpressen

ITALPRESSE re-inventa la pressa a caldo per falegnameria mettendo a frutto gli oltre 50 anni di esperienza nella costruzione di macchine per l'industria del legno. Le rivoluzionarie tecniche di fabbricazione adottate, unite al massiccio impiego di centri di lavoro a controllo numerico, ad una completa riorganizzazione del lavoro e al lancio di lotti economici di produzione consentono a ITALPRESSE di immettere sul mercato un prodotto completamente ingegnerizzato ed industrializzato. La conseguenza di tale sforzo organizzativo e' la possibilita' di offrire una pressa dalle caratteristiche qualitative eccellenti a prezzi molto competitivi. Nessun compromesso su qualita', affidabilita' e sicurezza. Solo il prezzo viene tagliato.



Contattate la rete commerciale ITALPRESSE e verificate di persona la convenienza della nuova gamma di presse a caldo ITALPRESSE mod. XL.

ITALPRESSE re-invents the woodworking hot press putting to interest its 50 years' experience in the manufacturing of industrial equipment. The use of revolutionary manufacturing techniques, the automated CNC machining of the steel components, the new organization of the workflow and the high production volumes allow ITALPRESSE to introduce on the market a completely engineered and industrialized product. The major consequence of such an effort is the possibility to offer a press with excellent quality features at competitive prices. No compromise on quality, reliability and safety; only the prices are cut. Get in touch with ITALPRESSE sales network and check yourself the convenience of the new range of ITALPRESSE hot presses mod. "XL".

ITALPRESSE hat diese neue Generation von Furnierpressen für Schreinereibetriebe basierend auf der 50 jährigen Erfahrung in der Herstellung von Maschinen für die Holzindustrie entwickelt. Mit der Baureihe XL haben wir das Preis-Leistungsverhältnis entscheidend zu Ihrem Nutzen optimiert: Kostenminimierte Fertigungsstrukturen unter anderem durch den erhöhten Einsatz von CNC-Bearbeitungszentren und die Auflage von Serien ermöglichen ein technisch ausgereiftes Produkt. Als Ergebnis präsentieren wir dem Markt eine Furnierpresse, die höchsten Qualitätsansprüchen genügt zu einem äußerst attraktiven Preis; dabei werden keine falsche Kompromisse hinsichtlich Qualität, Zuverlässigkeit und Sicherheit akzeptiert. Sprechen Sie mit uns und überzeugen Sie sich persönlich von den Vorteilen der neuen Heizplattenpresse Baureihe ITALPRESSE Mod. XL.

## CARATTERISTICHE TECNICHE - TECHNICAL DATA - TECHNISCHE DATEN

	Dimensioni piani Platen dimensions Plattenabmessungen mm (inch)	Pressione totale Total pressure Gesamtdruck Ton.	Apertura (standard) Opening (standard) Öffnung (standard) mm			Cilindri Cylinders Zylinder N.	Dimensioni di ingombro* Machine dimensions* Ausssenmasse* mm
			PA	PM	PE		
XL / 4 - S	2500 x 1300 / 98"x51"	50	400	370	350	4	3100 x 1800 x 2100
XL / 4	2500 x 1300 / 98"x51"	70	400	370	350	4	3100 x 1800 x 2100
XL / 6 - S	2500 x 1300 / 98"x51"	90	400	370	350	6	3100 x 1800 x 2100
XL / 6	2500 x 1300 / 98"x51"	120	400	370	350	6	3100 x 1800 x 2100
XL / 6 - K	3000 x 1300 / 118"x51"	50	400	370	350	6	3550 x 1750 x 1900
XL / 6 - J	3000 x 1300 / 118"x51"	70	400	370	350	6	3550 x 1750 x 1900
XL / 6 - S	3000 x 1300 / 118"x51"	90	400	370	350	6	3700 x 1800 x 2100
XL / 6	3000 x 1300 / 118"x51"	120	400	370	350	6	3700 x 1800 x 2100
XL / 8 - S	3000 x 1300 / 118"x51"	120	400	370	350	8	
XL / 8 - J	3500 x 1300 / 138"x51"	90	400	370	350	8	4300 x 1800 x 2100
XL / 8 - S	3500 x 1300 / 138"x51"	120	400	370	350	8	4300 x 1800 x 2100
XL / 8	3500 x 1300 / 138"x51"	160	400	370	350	8	4300 x 1800 x 2300
XL / 8	3200 x 1600 / 126"x63"	160	400	400	350	8	4000 x 2100 x 2300
XL / 8	4200 x 1400 / 165"x55"	160	400	400	350	8	5000 x 1900 x 2300
XL 10	3200 x 1600 / 126"x63"	190	400	400	350	10	
XL / 10	3800 x 1600 / 150"x63"	190	400	400	350	10	4400 x 2100 x 2300
XL / 10	4200 x 1600 / 165"x63"	190	400	400	350	10	5000 x 2100 x 2300

\* Dimensioni approssimative riferite a macchina con apertura standard senza piani intermedi.

\* Aproximate dimensions of a machine with standard opening without intermediate platens.

\* Ca.-Abmessungen der Presse bei Öffnung standard ,ohne Zwischenheizplatten

# La dotazione di serie

**XL:** Standard features

**XL:** Standardausstattung



- Apparecchiatura elettronica di comando e controllo della macchina
- Electronic operated interface to set and control the machine functions
- Elektronische Steuereinheit zur Steuerung und Überwachung der Maschine

- Timer di pressata digitale per l'apertura automatica con relativa esclusione
- Digital timer for the automatic opening of the press after the pressing cycle. Selector to exclude the automatic opening of the mobile platen
- Digitaler Zeitschalter zur Einstellung der Presszeit und automatisches Öffnen

- Impostazione e lettura digitale della temperatura di lavoro (N.D. su macchine con riscaldamento a caldaia)
- Digital setting and reading of the working temperature (Not available for presses heated with wood/coal boilers)
- Digitale Eingabe und Überwachung der Temperatur (nicht verfügbar auf Maschinen mit Heizkessel)

- Impostazione e lettura digitale della pressione di lavoro
- Digital setting and reading of the working pressure
- Digitale Eingabe und Überwachung des Pressdruckes

- Timer giornaliero/settimanale per la programmazione dell'avviamento del riscaldamento (N.D. su macchine con riscaldamento a caldaia)
- Daily/weekly timer to program the start up of the heating system (Not available for presses heated with wood/coal boilers)
- Wochenzeitschaltuhr zur Programmierung der Einschaltzeit der Heizung (nicht verfügbar auf Pressen mit Heizkessel)

- Esclusione della fila sinistra di cilindri (di serie su XL/8-XL/10, optional su XL/6)
- Electric exclusion of the left row of cylinders (standard on the XL/8-XL/10, optional on the XL/6)
- Ausschaltung der linken Zylinderreihe (serienmäßig auf XL/8-XL/10; optional auf XL/6)

- Sistema di diagnostica digitale con visualizzazione delle anomalie generali della macchina
- Digital diagnostic system complete with general machine errors displaying.
- Digitale Diagnose und Anzeige der Störungsmeldungen

- Selettore per la parzializzazione del boiler elettrico (di serie per macchine dotate di boiler di potenza superiore ai 18 Kw.)
- Selector to use 50% of the total power of the heating system to save energy. (standard on the presses with boiler power above 18 Kw)
- Schalter zur Leistungsreduzierung des Boilers (serienmäßig auf Maschinen mit Boiler über 18 Kw. Leistung)

- Regolazione dell'apertura della pressa
- Press opening regulation
- Regelung von der Öffnung der Presse



Cremagliera controllo planarità  
Rack and pinion for flatness control  
Zahnstange für Parallelbewegung



Gancio di sollevamento  
Lift hook  
Transporthaken



Adesivi con indicatori di sicurezza  
Safety labels  
Sicherheitshinweise



Diagramma lavoro  
Surface vs. Pressure Diagram  
Arbeitsdiagramm

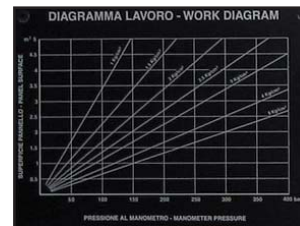

Interfaccia operatore  
Operator interface  
Digitales Eingabeterminal



Chiavistello per bloccaggio piani in fase di manutenzione  
Safety lock  
Verriegelungshaken für die Heizplatte bei Wartungsarbeiten



Tensionamento mylar (opt.)  
Mylar tensioning system (opt.)  
Mylar -Spannvorrichtung (opt.)

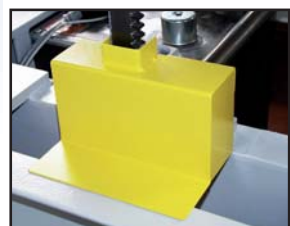

Carter di protezione organi mobili  
Metal safety covers  
Schutz-Abdeckung

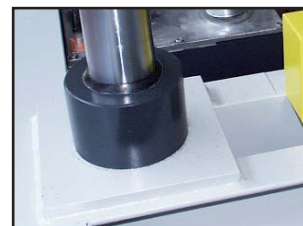

Appoggio inferiore cilindri rinforzato  
Reinforced lower cylinders plates  
verstärkte untere Zylinderauflageplatte



Supporto superiore cilindri libero  
Cylinder thrust plates  
obere Zylinderauflageplatte  
schwimmend befestigt

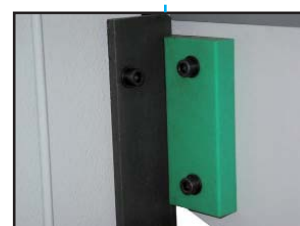

Guida piano mobile  
Platen guides  
Führung des unteren Preßtisches



Guida piano mobile  
Platen guides  
Führung des unteren Preßtisches



Centralina idraulica accessibile  
Easy access hydraulics  
leicht zugängliche Hydraulikeinheit



Viti per messa in bolla  
Leveling bolts  
Schrauben zur Nivellierung



Impianto di riscaldamento  
Heating system  
Heizkreisanschlüsse



Boiler elettrico per olio diatermico  
Electric boiler for thermal oil  
Elektro-Öl-Boiler



Fune più interruttore di sicurezza  
Perimeter E-stop System  
Sicherheits-Reißleine mit Schalter



Finecorsa apertura piano  
Limit switch for press opening  
Endschalter "Öffnung Presse"



Quadro comandi ergonomico  
User-friendly operator console  
ergonomisches Bedienpult



# XL: Caratteristiche costruttive

## XL: Construction Details

### XL: konstruktive Eigenschaften

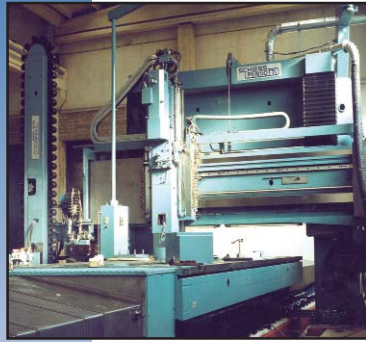

In termini di **solidità, robustezza ed affidabilità** le presse **XL** non hanno uguali nella loro categoria. La scelta **ITALPRESSE** di fabbricare internamente ogni componente meccanico consente un controllo di qualità totale su ogni fase produttiva. L'utilizzo dei componenti idraulici ed elettrici di 1° scelta contribuisce a fare di **XL** un prodotto di assoluto riferimento.

The **solidity and stiffness of XL** construction are far superior to many other competitors' presses because **ITALPRESSE** manufactures every mechanical press component in its own shops to ensure complete control of quality in every phase of construction. Coupled with the best electrical and hydraulic components on the market, the **XL** is the benchmark of presses in its class.

Was die **Stabilität** und die **Zuverlässigkeit** der Pressen "**XL**" betrifft scheuen wir keinen Vergleich mit ähnlichen Produkten. Alle mechanischen Teile werden selbst hergestellt und erleichtert eine umfassende Qualitätskontrolle in allen Produktionsphasen. Es werden nur erstklassige hydraulische und elektrische Komponenten verwendet.

**STRUTTURA:**  
La struttura della pressa è realizzata in **normal profili**. I **componenti del telaio** vengono saldati utilizzando apposite **dime di saldatura**. I **panconi mobili e fisso** della pressa sono costruiti utilizzando **normal tipo HEA**. I **componenti saldati** subiscono un trattamento di **distensione termica** onde eliminare ogni tensione meccanica. **Tutti i particolari vengono lavorati su macchine a CNC.**

**FRAME:**  
Each XL frame is fabricated by **welding formed structural steel components** together in proprietary fixtures. **Mobile and fixed platen bolsters** are manufactured using **HEA preformed steel components**. All welded assemblies are **stress relieved** to alleviate all residual thermal stresses and are then **CNC machined to assure precision, uniformity and interchangeability.**

**PRESSENGESTELL:**  
Das Pressengestell besteht aus einer schweren verwindungssteifen und spannungsfrei geschweißten **Stahlkonstruktion**. Beide **Preßtische** sind aus **HEA-Profilen** geschweißt. Alle **Verbindungen** sind mit einem **thermischen Entspannungsverfahren** behandelt. Die **Bearbeitung der Baugruppen erfolgt auf CNC-Bearbeitungsmaschinen.**

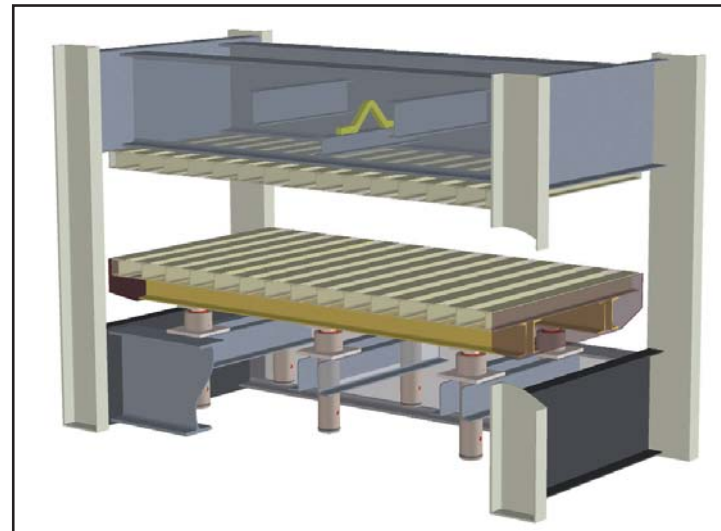

#### CILINDRI:

Le **camicie in acciaio Fe 510/C**, sono realizzate su **centro di saldatura robotizzato** in atmosfera controllata. Lo **stelo** è ricavato da una barra di **acciaio legato 40 Ni Cr Mo 4**. Sullo **stelo** pre rettificato viene effettuato un **riporto di cromo** a forte spessore per garantire una **maggiore resistenza all'usura ed un migliore scorrimento**. Quindi lo stelo viene rettificato nuovamente. La **toleranza** di accoppiamento **Stelo/Camicia** è controllata con apposito calibro onde garantire la **intercambiabilità** e la **perfetta tenuta** delle guarnizioni. La **camicia**, che appoggia su una **sede circolare**, e lo stelo sono liberi di muoversi per tener conto della dilatazione termica.

#### HYDRAULIC CYLINDERS:

The XL's hydraulic **cylinder casings** are **fabricated from FC 510/C grade steel** and **robotically welded in an inert atmosphere**. The **rams** are **manufactured with chrome-plated double precision-ground 40 NI CR MO 4 round stock**. The double grinding cycles assure diametrical uniformity, superior surface finish and proper fit with the cylinder casings and gasket seals. Each **cylinder sub-assembly** is then housed in a **circular seat** that helps limit thermally-induced stresses.

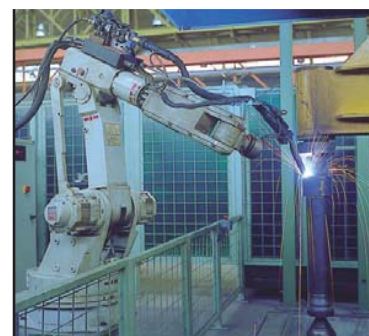

#### ZYLINDER

Die **Gehäuse** bestehen aus **Stahl Fe 510/C** und werden ebenso auf **CNC-Bearbeitungsmaschinen** bearbeitet. Die **Kolben** werden aus Stangenmaterial aus **niedriglegiertem Stahl 40 ni Cr Mo4** herausgearbeitet: die vorgeschliffenen **Kolben** werden **verchromt** für eine **höhere Verschleissfestigkeit und eine bessere Gleitfähigkeit**. Dann wird der Kolben nochmals geschliffen. Die **Toleranz** der Baugruppe **Kolben-Gehäuse** wird geprüft, um den **Austausch** und den **perfekten Sitz** der Dichtungen zu gewährleisten. **Temperaturausdehnungen** können durch einen **kreisförmigem Sitz** kompensiert werden.

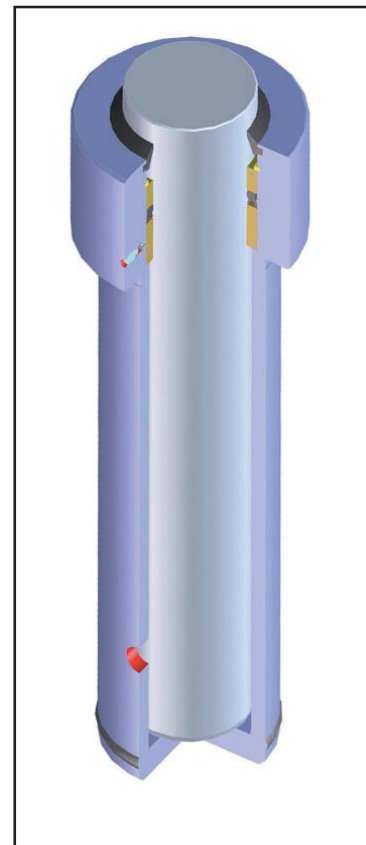

# XL: Impianto idraulico

## XL: Hydraulic system

### XL: Hydraulikeinheit



La pressa è dotata di centralina idraulica compatta **che comprende:**

A powerful, compact hydraulic power supply mounted in the base of each XL press and consists of the components diagrammed **on the right:**

Die Presse ist mit einer hydraulischen Einheit ausgerüstet, **bestehend aus:**

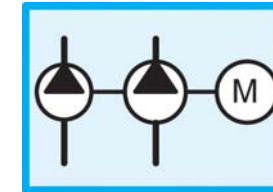
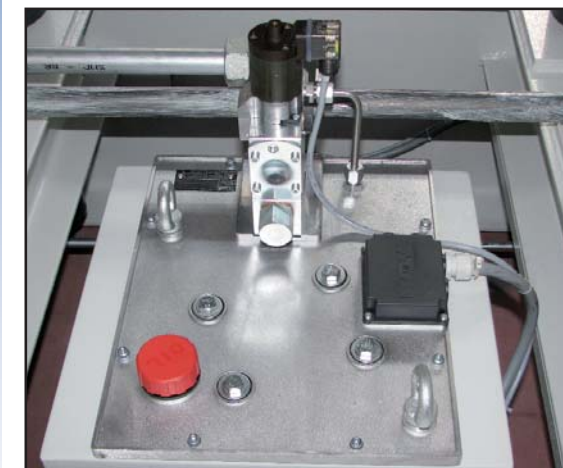

**Gruppo motore-pompa sommersa**  
Submersed motor pump group  
Motor-Pumpe-Einheit

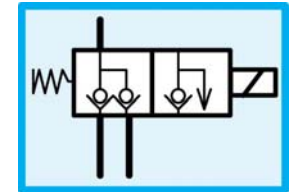

**Gruppo elettrovalvole**  
Solenoid valves group  
Elektroventile

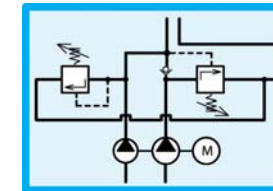

**Pompa doppia con valvola disgiuntiva**  
Two stage pump with pressure relief valve  
doppelte Pumpe mit Druckentlastungs-Ventil

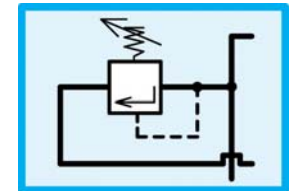

**Valvola di massima**  
Relief valve  
Max.Ventil

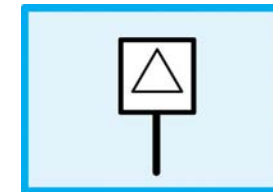

**Trasduttore di pressione**  
Pressure transducer  
Wandler

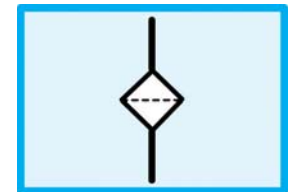

**Filtro olio**  
Oil filter  
Ölfilter

# XL: Impianto elettrico e quadro comandi

## XL: Electrical system and operator console

### XL: elektrische Anlage und Bedienpult

Costruito secondo la più severa normativa CE/89/392, certificato su richiesta anche secondo le normative CSA-UL-VDE Comprende un PLC per il controllo automatico di tutte le funzioni della pressa.

Il quadro comandi comprende il selettore di accensione, il doppio pulsante temporizzato per chiusura pressa, il pulsante di apertura, il pulsante di emergenza con reset, la nuovissima interfaccia elettronica di controllo.

L'interfaccia consente una programmazione di tutti i parametri di pressata; pressione, temperatura, tempo, esclusione dei cilindri, temporizzazione del riscaldamento.



Every XL electrical system is built in strict compliance with CE/89/392 safety regulations and is also certified to CSA, UL, and VDE standards. A PLC integrated into the operator console controls all press functions. Mounted on the front panel are the main power switch, a two-hand timed operator pushbutton system for safely closing the press, a single pushbutton for opening the press, a programmable press cycle timer, a programmable temperature setpoint control, a cylinder lock-out pushbutton, and a resettable e-stop switch.

gemäß CE/89/392, auf Anfrage zertifiziert gemäß CSA-UL-VDE-Normen. Speicherprogrammierbare Steuerung für automatische Steuerung und Kontrolle. Der Schaltschrank enthält einen Hauptschalter, eine Zweihand-Schaltung zum Schliessen der Presse, einen Druckknopf "Öffnen", einen Not-Aus-Schalter mit Reset, Preßzeit-Schaltuhr, Telethermometer zur Temperaturregelung (Zusatzeinrichtung) sowie die Funktion "Ausschaltung Zylinderreihe" (Zusatzeinrichtung)





## XL: Tipi di piani riscaldanti

XL: Type of heating platens

XL: Heizplatten - Typen

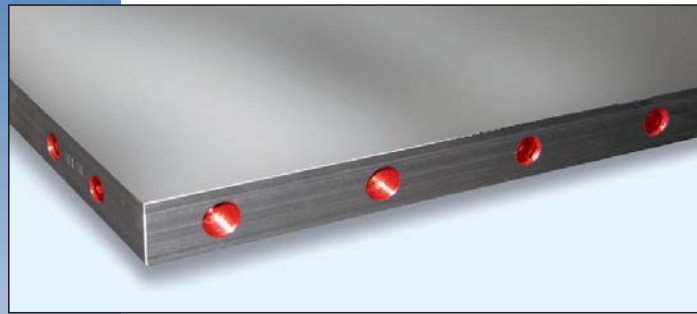

### PM: SOLID STEEL PLATEN

- Each platen is machined of **Fe 430/B** grade steel plate to assure flatness and a smooth surface finish.
- **Deep channels** for the heating oil are gun drilled with diameters appropriate to the thermal and dimensional characteristics of the press.
- Working surfaces of the **platens are covered with mylar, Teflon, or aluminum sheet.**

### MASSIVE STAHLHEIZPLATTEN

- Platten aus Stahl **Fe 430/B**. Die Bearbeitung der Platten erfolgt mit **CNC Bearbeitungsmaschine.**
- **Die Plattenoberflächen werden exakt gefräst und geschliffen.**
- Bohrungen für die Thermoöl-Zirkulation.
- Der **Durchmesser** der Bohrung wird gemäss den geometrischen und thermischen Daten der Presse **optimiert.**
- **Die Plattenoberfläche** wird mit **Mylar-Folie** oder mit **Aluminium** Platten verkleidet.

### P.M.: PIANO MASSICCIO:

- Piano realizzato in lamiera di acciaio **Fe 430/B** di forte spessore lavorato su **centro di lavoro a CNC.**
- **Elevato grado di finitura superficiale.**
- Circuito olio ricavato mediante foratura profonda su macchine foratrici ad alta specializzazione.
- **Diametro** del foro **ottimizzato** alle caratteristiche geometriche e termiche della pressa.
- **Superficie di lavoro** del piano ricoperta con **mylar** oppure con fogli di **alluminio.**

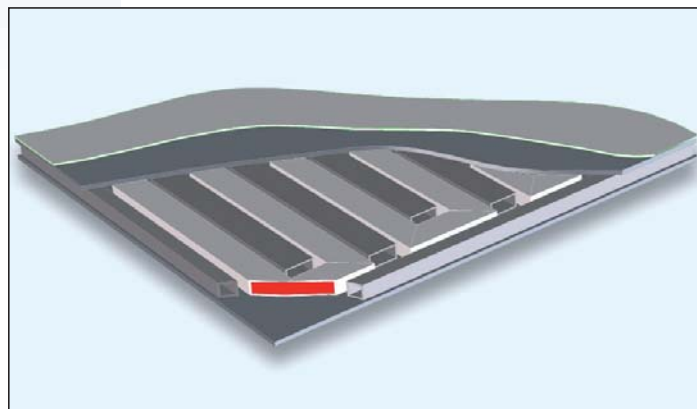

### P.A.:PIANO ASSEMBLATO

In cui possiamo distinguere:

- **Serpentine** in cui circola il liquido riscaldante.
- **Tubolare di riempimento** degli interspazi.
- **Lamiere di contenimento** inferiore e superiore.
- **Pannello isolante.**
- **Alluminio** spessore 9/10 per copertura piani.

### PA: FABRICATED PLATEN

- Fabricated platens are made using **square cross-section steel tubing** fixed between two steel plates.
- Steel tubing used to circulate the heating oil is configured as a **continuous serpentine conduit fixed to a steel sub-plate.**
- Gaps in the conduit array are filled with lengths of square steel tubing.
- A second steel plate is fixed opposite the first plate to form a sandwich with the tubing.
- **Platens are then covered with thin aluminum sheet.**

### STAHLROHR-HEIZPLATTE:

- **Röhren in Schlangenform** für den Umlauf der Heizflüssigkeit.
- **Füllungsstäbe** in den Zwischenräumen.
- **Sandwich-Konstruktion** mit abschließendem oberem und unterem Stahlblech.
- **Isolierplatte.**
- **Aluminium** zur Verkleidung der Platten, Stärke 9/10.

### P.E. PIANO ELETTRICO

Originale **tedesco.**

- Superficie disponibile con finitura elossidale.

### PE: ELECTRIC PLATEN

- These platens are sourced from our quality German supplier
- Electrical heating coils are imbedded in the platen instead of oil channels or conduit
- Platens are fabricated of hard anodize-finished aluminum

### ELEKTRISCHE HEIZPLATTE:

**deutsches** Markenfabrikat  
Eloxierte Oberfläche auf Wunsch

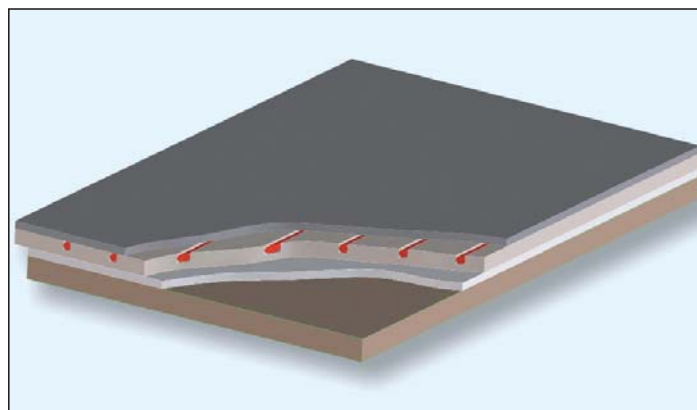

## XL: Tipi di riscaldamento

XL: Types of heating

XL: Heiz – Varianten

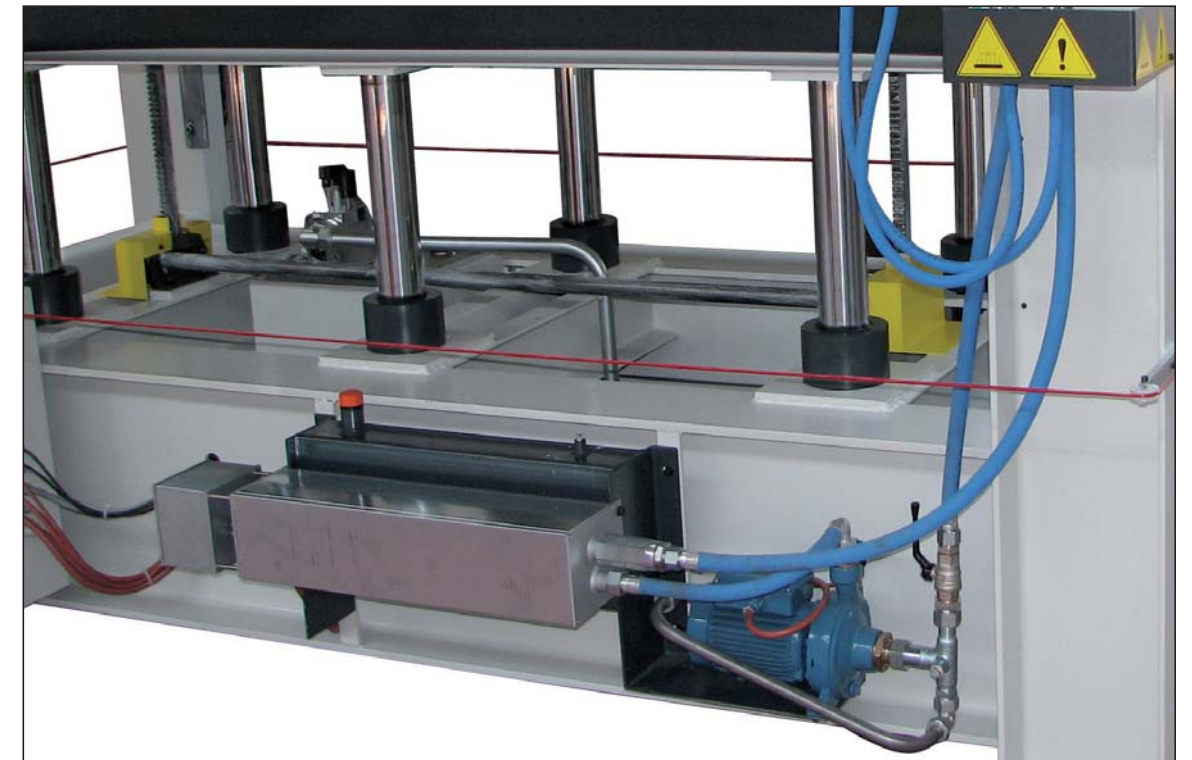

Le presse possono utilizzare differenti soluzioni per il riscaldamento dei piani. In alcuni casi è disponibile un sistema centralizzato di riscaldamento tipo: vapore, acqua calda, acqua surriscaldata. Nella maggioranza dei casi la pressa è dotata di un suo sistema autonomo di riscaldamento:

### • OLIO DIATERMICO CON BOILER ELETTRICO (foto)

Riscaldamento con un boiler elettrico;  
pompa di circolazione;  
vaso espansione;  
selettore per ridurre il consumo a regime (di serie per potenze >18kw);  
elettrovalvola spurgo aria;  
termoregolatore di sicurezza;  
sonde per rilevare la temperatura dei piani;  
valvola manuale per esclusione pompa dal circuito;  
flessibili collegamento piani in acciaio.

### • CALDAIA A LEGNA E/O CARBONE

Completa di:  
vaso espansione;  
kit di sicurezza e collegamento (optional)

### • SCAMBIATORE DI CALORE, ACQUA CALDA / OLIO

### • PIANI ELETTRICI

XL press platens can be heated with a variety of heating systems. In some factories central sources like steam, hot water and super heated water may be used to heat the XL's solid steel or fabricated platens. Wood or coal –fired boilers may also be considerations. Since regulating the temperatures of the platens using these fuel sources can be a challenge, in the US we provide either time-tested electric boiler systems or electric platens specifically designed for your press.

### THERMAL OIL WITH ELECTRIC BOILER: (see photo above)

thermal oil heating with electric boiler;  
circulating pump;  
expansion tank;  
energy saving selector (standard on the presses with boiler power > 18 Kw);  
air spill valve;  
safety thermostat;  
temperature probes;  
ball valve to separate boiler;  
steel flexible hoses to connect platens;

### • WASTE WOOD OR COAL BOILER

Complete with:  
expansion tank;  
safety and connection kit. (optional)

### • HEAT EXCHANGER-OIL / WATER

### • ELECTRIC PLATENS

Die Heizplatten können mit verschiedenen Medien beheizt werden. Falls bauseitig verfügbar: Dampf, Warmwasser, Thermoöl. In meisten Fällen ist die Presse mit einem unabhängigen Heizsystem ausgerüstet :

### • THERMOÖL UND ELEKTRO-BOILER (siehe Photo)

Beheizung mittels Elektro-Boiler  
Umlaufpumpe;  
Expansionsgefäß;  
Wählschalter zur Verbrauchsreduktion (serienmäßig auf Maschinen mit Boiler über 18 Kw. Leistung);  
Entlüftungs-Elektroventil Sicherheitsthermoregler;  
Thermofühler;  
Kugelhahn zum Absperrern des Thermo boilers;  
Flexible Verbindungsschläuche zu den Heizplatten

### • HOLZ U/O KOHLE-KESSEL

Komplett mit:  
Expansionsgefäß  
Sicherheits- und Verbindungs-Kit (optional)

### • WÄRMETAUSCHER WARMWASSER/ÖL

### • ELEKTRO-HEIZPLATTEN



# XL: Sicurezza d'uso

## XL: Safety devices

## XL: Sicherheitseinrichtungen

### SICUREZZA:

L'UFFICIO SICUREZZA, prodotto di Italtipresse S.p.A. ha analizzato ogni rischio di impiego della XL ed ha modificato il progetto della pressa per renderla ancor più sicura, Tali dispositivi sono strettamente di serie:

### SAFETY:

safety is paramount in the design, manufacture and use of all ITALPRESSE S. p. A. press products and accessories. We've designated a department to address safety issues as they relate to our products and to ensure that all products meet or exceed established practices. This is an ongoing process as safety standards are continuously being updated and ITALPRESSE S. p. A. revises current products and releases new models for sale. Below are examples of our common practices.

### SICHERHEIT

UNSERE EIGENE SICHERHEITS-ABTEILUNG überprüft ständig die Sicherheitseinrichtungen der Presse XL und paßt sie permanent den neuesten Erkenntnissen und Vorschriften an. Serien-Zusatzeinrichtungen:

"Dichiarazione CE" per paesi in cui è richiesta.



"CE Declaration" For those countries requiring it.

CE-Konformitätserklärung wo erforderlich

Carter protettivi per le aree a rischio.

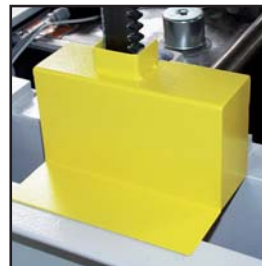

Metal protective covers: For potentially dangerous areas.

Schutz-Abdeckungen von Quetschstellen etc.



Bloccaggio meccanico del piano mobile in fase di manutenzione.

Mechanical platen lock to prevent movement.

Verriegelungshaken für die Heizplatte bei Wartungsarbeiten

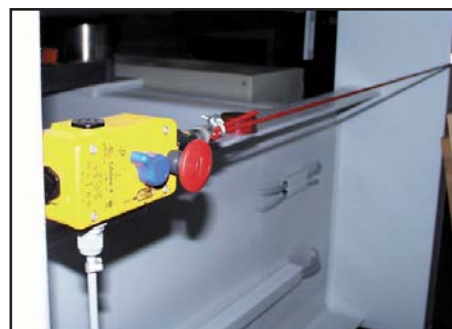

Fune di sicurezza con interruttore a strappo lungo il perimetro.

Perimeter e-stop safety cable and switch

Sicherheits-Reißleine rund um die Maschine



Targhette adesive di pericoli e precauzioni

Adhesive stickers to advise of precautions and dangers

Aufkleber mit Sicherheitshinweisen

Doppio pulsante temporizzato per chiusura pressa con comando a due mani



Two-hand timed press closure push-button switches

Zwei-Handschtaltung zum Schließen der Presse

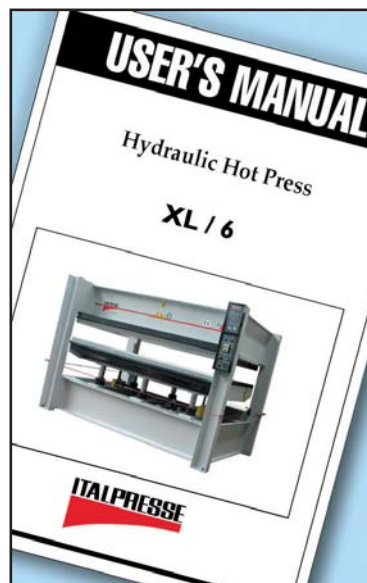

Documentazione tecnica completa di:  
• Istruzioni uso e manutenzione  
• Diagrammi idraulici e pneumatici  
• Schemi elettrici  
• Lista pezzi di ricambio  
• Dichiarazione di conformità

Technical documentation complete with:  
• Use and maintenance instructions  
• Hydraulic and pneumatic diagrams  
• Electrical diagrams  
• Spare parts list  
• Declaration of conformity  
• Notes on precautions and areas of danger

Technische Dokumentation komplett mit:  
• Bedien- und Wartungsanleitungen  
• Hydraulik- und pneumatik-Pläne  
• Elektro-Schaltplan  
• Ersatzteilliste  
• Konformitätserklärung

# XL: Optionals

## XL: Optionals

## XL: Zusatzeinrichtungen

Le presse XL, già riccamente dotate nella versione base, possono essere completate con una serie di optionals che ne aumentano l'efficienza, la produttività o la facilità d'uso:

The XL press is already loaded with standard features. The following options are available to increase its efficiency, productivity, and ease of use.

Die XL, die bereits in der Grundversion großzügig ausgestattet ist, bietet viele Optionen, die die Leistungsfähigkeit, die Produktivität und die Bedienfreundlichkeit verbessern:



### Piani intermedi:

i piani intermedi possono essere aggiunti per aumentare la produttività della XL.

### Intermediate platens:

the intermediate platens can be added to increase the productivity of the XL.

### Zwischenheizplatten

zur Kapazitätserweiterung

Apertura vano maggiorata: il vano della pressa può essere aumentato fino a mm. 600-620-650.

Increased daylight opening: the opening of the press can be increased up to mm. 600-620-650

vergrößerte Etagenöffnung bis 600-620-650 mm

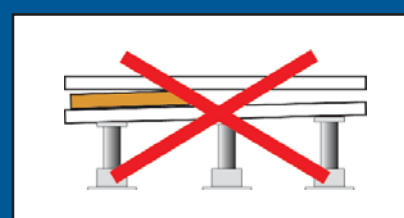
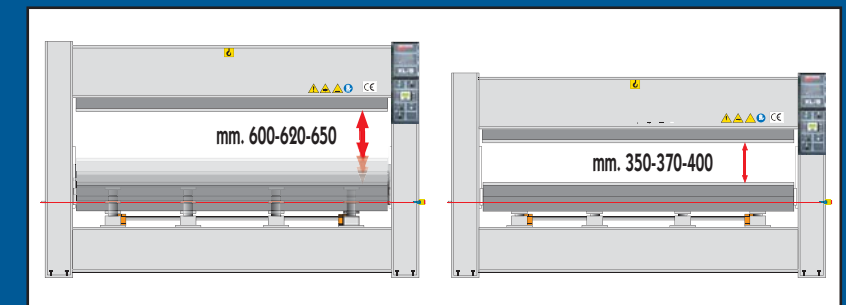

Controllo elettronico planarità [EFC]: questo dispositivo interrompe il ciclo di pressata in caso di carico non corretto o di sovrapposizione dei pannelli.

Electronic flatness control (EFC) : this device stops the press cycle in case of improper loading of panel

elektronische Ebenheitskontrolle (EFC) als Schutz vor Fehlbelegungen

Esclusione elettrica dei cilindri: [ACE] per parzializzare l'uso del piano pressa.

Electrical cylinder exclusion (ACE): for the partial use of the press platen.

Elektrische Zylinder-Ausschaltung (ACE) bei verringerter Preßfläche

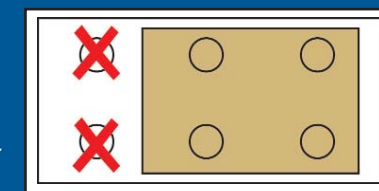

Controllo a Touch-screen

Touch screen operator interface

Touch-screen Bedienung



# Italpresse S.p.A.

## Un esteso programma di Produzione

La costante attenzione al progresso tecnologico nel settore del legno, ha consentito ad **ITALPRESSE S.p.A.** di estendere nel tempo la gamma della sua produzione, che è oggi fra le più significative e complete presenti sul mercato internazionale. La sua produzione comprende: • Presse monovano e multivano con caricamenti manuali ed automatici per la produzione di pannelli di compensato, pannelli rivestiti con tranciati, laminati plastici decorativi e carte • Presse per stampaggio • Presse a membrana • Presse per curvare • Strettoi per corpi di mobili, infissi, listellari • Spalmatrici • Dosatori mescolatori per colle • Incollatrici, giuntatrici • Taglierine per impiallacciatura • Impianti automatici per listellare • Strettoio e impianti per lamellare • Impianti completi di pressatura in genere, completamente automatizzati.

The constant attention to the technological progress of the woodworking industry has granted **ITALPRESSE S.p.A.** the extension of its range of products, so that today it is one of the most significant and complete at the disposal of the international market. The production includes: • Single and multi-daylights presses with manual and automatic loading for production of plywood panels, panels laminated with veneer, decorative plastic laminates and papers • Embossing presses • Membrane presses • Bending presses • Windows, cabinets and beams presses • Glue spreaders • Mixing and dosing units for glue • Veneer stitchers • Veneer guillotines • Automatic lines for wood strips • Different kinds of fully automatic press lines.

Durch ständige Marktbeobachtung haben wir unser Herstellungsprogramm so erweitert, dass

**ITALPRESSE S.p.A.** heute eines der bedeutendsten und international führenden Unternehmen seiner Branche geworden ist. Zu unserem Herstellungsprogramm zählen: „Hydraulische Ein- und Mehretagenpressen, mit manueller oder automatisch Beschickung, zur Herstellung von Sperrholz, Möbelteilen; sowie Pressen zur allgemeinen Veredelung von Plattenmaterialien mit Echtholz furnier, Dekorpapieren und Folien, wie z.B. Prägepressen, Membranpressen, Formpressen für MDF, automatische Kurztakt-Massivholzpressenanlagen, Pressen für Lamellierholz, Rahmenpressen und Korpuspressen; ferner Leimauftragsmaschinen, Klebstoffmischanlagen, Leimdosieranlagen, Furnierscheren, u.s.w.



I dati e le immagini riportati nel presente catalogo sono puramente indicativi e possono essere modificati senza preavviso.

The technical data and the pictures shown in this catalogue are subject to modification without notice.

Änderungen der technischen Daten auch ohne Vorankündigung vorbehalten. Abbildungen können von Originalware abweichen.

# ITALPRESSE

**Italpresse S.p.A.** 24060 BAGNATICA (BG) - ITALIA  
Via delle Groane, 15 Tel.: +39 035 666341 - Fax: +39 035 6663400  
E-Mail: [sales@italpresse.com](mailto:sales@italpresse.com) - Web: [www.italpresse.com](http://www.italpresse.com)



Italpresse USA, inc. 26520 Mallard Way, Punta Gorda, Florida 33950  
Ph. (941) 639-2100 - Fax: (941) 639-1663  
E-Mail: [sales@italpresseusa.net](mailto:sales@italpresseusa.net) - Internet: [www.italpresseusa.net](http://www.italpresseusa.net)