

CONTROL

EVOLUTION

STANDARD

COMPACT

■ STRIEBIG ■

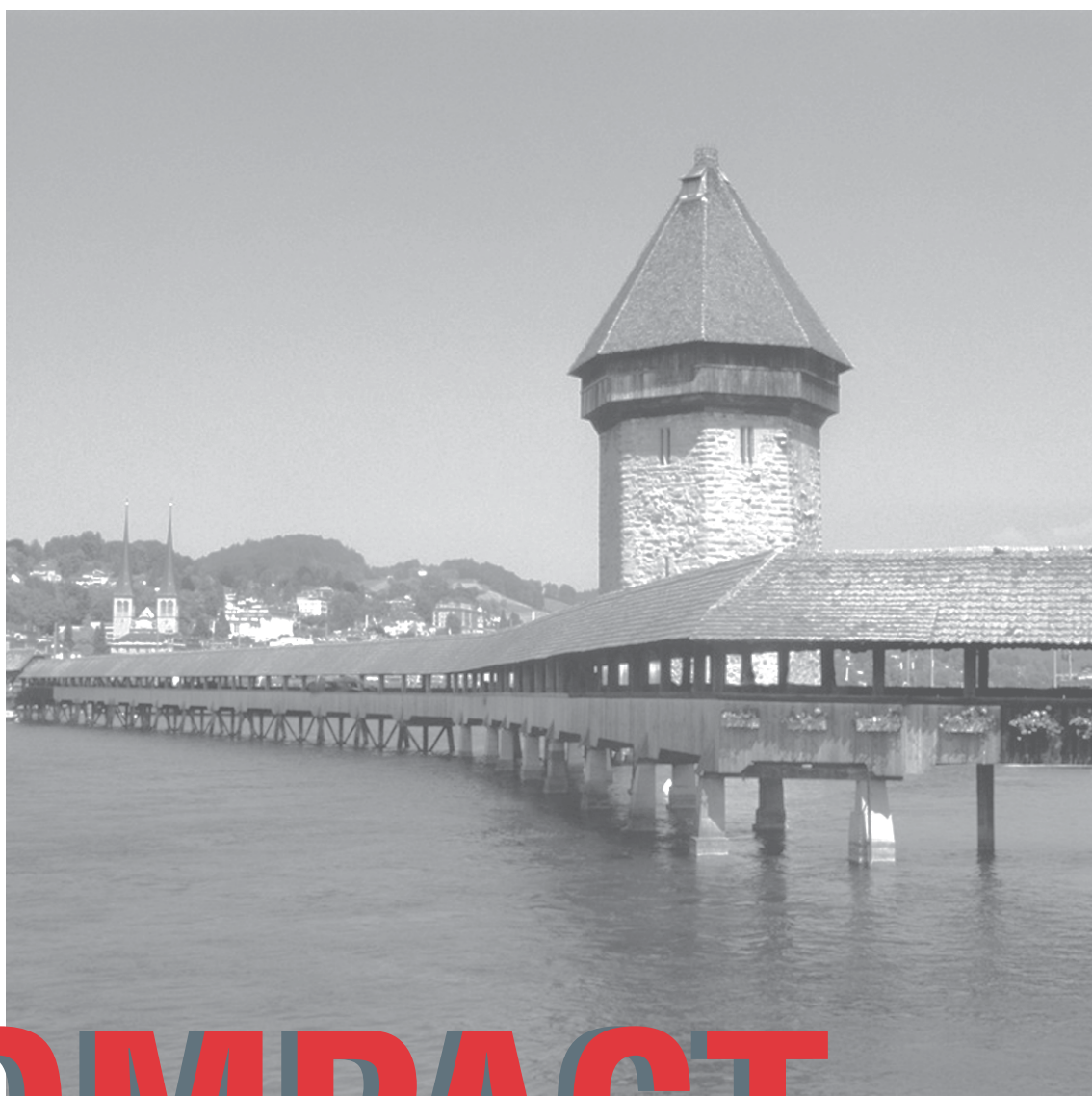

COMPACT

Flexible and cost-effective.
Moving into vertical sawing technology.

From vision to market leadership

50 years of successful company history:
The "simple" panel saw becomes an all-purpose standard machine for all sawing and grooving work.
The vision of our company founder, Ludwig Striebig, has become reality!

Standstill is a foreign word to us. Every single day we continue to work on the optimization of the vertical sawing technology. Striebig AG is the only manufacturer of vertical panel saws in the world which exclusively specializes in this individual product category. Therefore we probably have the most comprehensive expertise!

Our vertical panel saws stand for excellent user benefit, spirit of innovation, long life cycle and proverbial „Swiss precision“.



Built corporate identity: Vertical aluminium pilaster strips subdivide the front of our principal office in Littau in the near of Luzern, and establish a good reference to our products and market partners.

The principle is the sizing cut

The principle with all Striebig panel saws is the sizing cut. Our commitment is the perfectly fitting, dimensionally accurate edge that is ready to be glued. Thinking and acting holistically in all of our company processes is our guarantee for edge-sharp and precise cuts.

Our focussing on one single product segment, the experience gained during many years of research and development work, strictest quality guidelines for the materials used, very considerable in-house production depth as well as the certifications according to ISO 9001, ISO 14001 and OHSAS 18001 have enabled us to reach this high level of vertical panel saws.



"Classic and prizewinning" Striebig design: Saw unit and control unit of the COMPACT AV. Easy operability has always been the trademark of Striebig.



The principle of the sizing cut in in perfection. Especially the manufacture of high-quality furniture and interior fittings requires precisely cut edges which are ready to be glued as essential quality criterion. Ideal tool for this task is: Striebig COMPACT.



COMPACT

Our title picture shows the Chapel Bridge in Lucerne. The Chapel bridge, the oldest wooden bridge in Europe, with its rich series of paintings and water tower is the undisputed landmark of our city.

Essential advantages of the "vertical system"

Space saving, precise and efficient – the vertical sawing technology ideally combines precision and cost effectiveness. In many fields of application, it is the only possible, cost-effective and space saving solution for panel cutting. Vertical panel saws offer benefits which often cannot be realized by horizontal cutting centres.

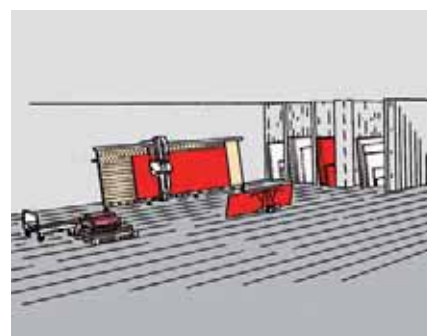
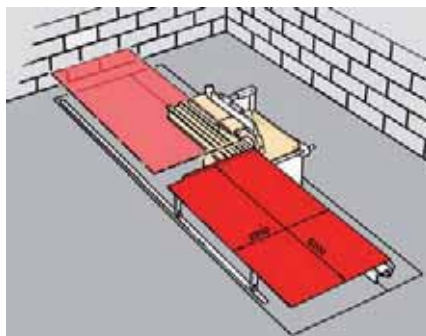
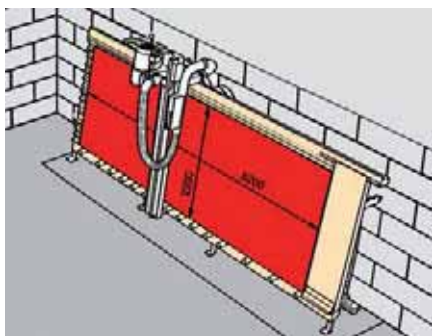

Advantages with regard to space requirement

The vertical panel saw needs approximately half the space of a horizontal cutting centre for handling the same panel size. Considering the space requirement for the panel storage, as well, the space advantage of the vertical sawing technology becomes even more apparent.

	vertical panel saw	horizontal panel cutting system
space requirement	100	up to 185
fixed costs p.a.	100	up to 148
variable costs/hour	100	up to 154

Advantages with regard to price-performance ratio

3:0 in favour of the vertical panel saw. It offers clear advantages over the horizontal panel cutting centre with regard to the cost-benefit contemplation.

Advantages with regard to precision and sawing technology

The Striebig saw frame is torsionally rigid and guarantees absolute parallelism between upper guide rail, central support and lower roller support. Another advantage: The panel stands absolutely safely so that no "untidy saw cut" can occur.

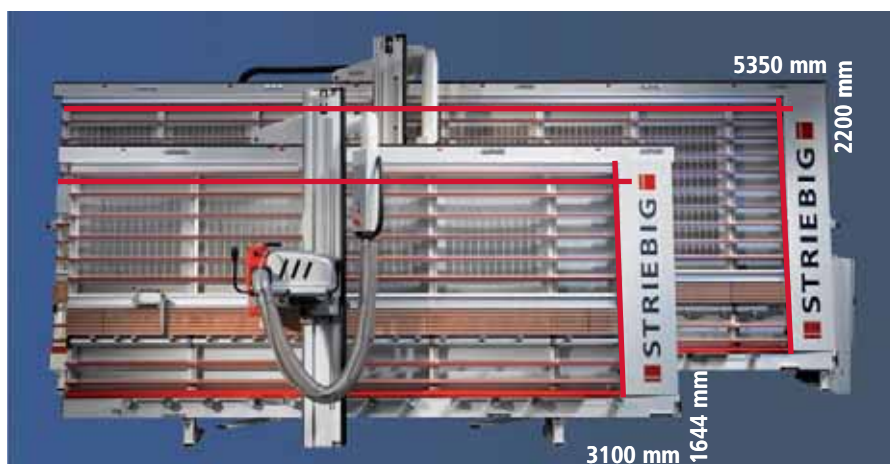
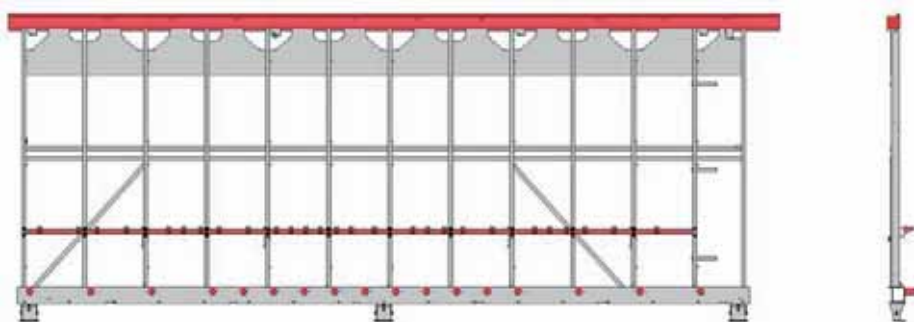

Versatile use

COMPACT covers a cutting range from 3100 x 1644mm (model 4164) to 5350 x 2200mm (model 6220).

Moving into quality and precision – 2 versions for all wishes

COMPACT or COMPACT Av - whether you saw manually or with automatic forward feed - it's your choice. The COMPACT series is characterized by a flexible and cost-effective use. It is the series for moving into the precision and quality world of vertical Striebig panel saws.

COMPACT combines exemplary ergonomics with high functionality to a harmonious unit with high-quality visual appearance. Even the COMPACT standard version comes comprehensively equipped ex works. Many equipment details are exclusively available from Striebig. Original Striebig accessories enable you to further extend comfort and performance of your COMPACT machine and to adapt it to the very individual requirements of your company.



Versatile use – (nearly) unlimited variety – with every Striebig COMPACT, you can saw an abundance of panel materials, and you get precise and edge-sharp results. All COMPACT versions are also ideally suited for milling and grooving work.

COMPACT AV 6220 – ill. contains optional equipment

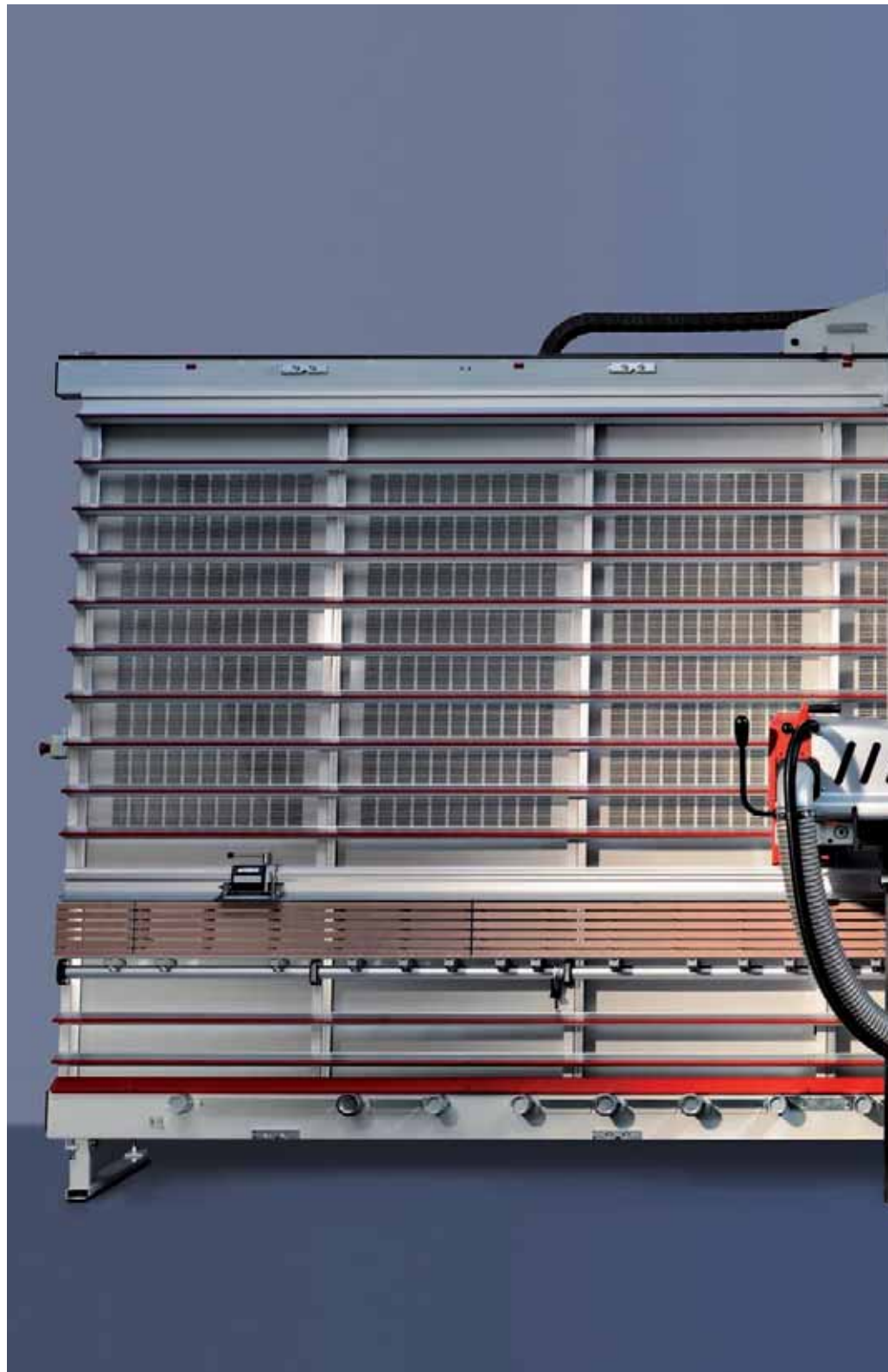

COMPACT

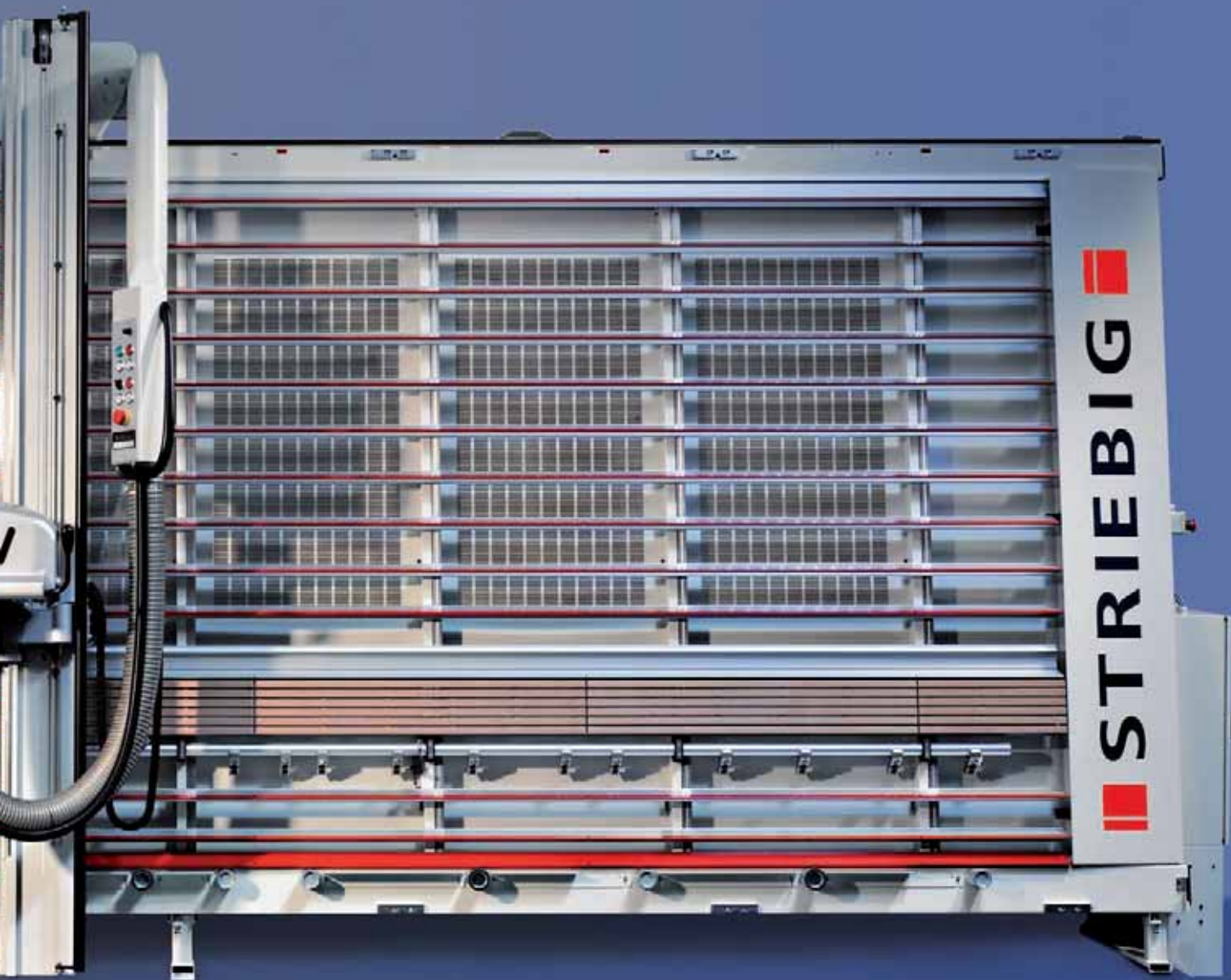

Innovation that goes into detail



Saw unit with powerful motor (3.9 kW) and length-adjustable operating lever, which significantly facilitates penetration.

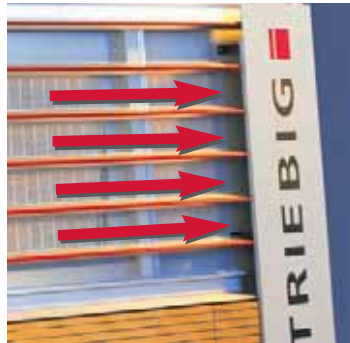

Integrated, especially powerful TRK dust extraction. Dust limit value clearly below 1mg/m³.



Central support and small parts support over the entire length provide increased comfort while cutting small parts. The central support consists of resistant aluminium support grids. Optional feature for demanding panel coatings: High end support grids made of synthetic material.



COMPACT AV – pneumatically braked support rollers as standard equipment. COMPACT – mechanically braked support rollers as optional equipment.



The plunging-in device (mechanical trapping hook) supports the safe plunging operation of the saw unit in the overhead area.



The mirror on the saw beam facilitates orientation with respect to the vertical cutting point (important to larger and overlaying panel sizes).

Automatic, cost-effective, efficient – COMPACT AV at a glance

Sawing with automatic forward feed - the sawing unit does not require any exhausting shifting process - easier work for the operator – all these benefits are provided by COMPACT AV.



■ Automatic forward feed

A separate motor ensures the automatic forward feed in horizontal and vertical direction. 4 feeding speeds (10/14/18/25 m/min) are available. The feeding speed can be freely selected by means of a rotary switch. No effort must be made by the operator for the forward feed.

■ Sawing at the push of a button

In the automatic mode, the saw unit of COMPACT AV automatically plunges into the material, cuts the panel horizontally or vertically and plunges out automatically after the cutting operation. The saw stops at the end of the panel. By selecting an automatic reverse motion (25 m/min) the saw returns to its original position afterwards.

■ Cost-effective sawing process

The operator is not required to do physically exhausting work. Therefore the operator can fully concentrate on cutting, dimensioning and unloading the panels. The sawing process is automatically and very evenly carried out with highest precision. Considerable time savings are reached.

■ High operational comfort

Comfortable and efficient saw operation by means of the control unit.

The control unit of COMPACT AV has been ergonomically arranged at eye level. Due to its well arranged display, the saw can be operated efficiently and centrally.

Original Striebig accessories: Individual extension

COMPACT and COMPACT AV come comprehensively equipped ex works. Due to a wide range of accessories offered, you can further extend comfort and performance of your COMPACT and fully adjust the machine to your individual needs.

	COMPACT	COMPACT AV
 optional		
 Standard		
Automatic sawing process	–	S
Scoring saw unit VSA		
Digital measuring system DMS		
Angle cutting unit WSG		
Strip cutting gauge 400 mm / 600 mm		
Central and small parts support over the entire length	S	S
Aluminium small parts support (1 pair)		
Central support: aluminium support grids	S	S
Central support: high-end support grids made of synthetic materials		
Grooving accessory for composite panels		
Profile cutter with reversible carbide tips: U-shape, 135°, 90°		
Depth stop for adjustable grooving tool		
Turnover board adjustable groover		
Mechanically braked support rollers		–
Pneumatically braked support rollers	–	S
Extension of the feeding speed (5-25m/min)	–	
Special voltage		
Tropical insulation		



Scoring saw unit VSA with infinitely adjustable saw blade. It safely prevents damage to the edges. Time, cost and tool cost savings are reached. If coated panels of a possibly lower quality level are processed, in our opinion, VSA is a "must"!



Strip cutting gauge, 400 and 600 mm in length with edge-protecting roller support.



The angle cutting unit WSG maintains the set dimension accurately in all angle positions.

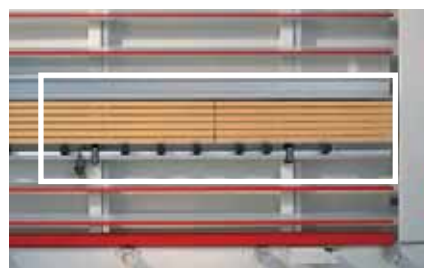

Continuous central and small parts support over the entire length for increased comfort while cutting small parts. Series: Central support made of resistant aluminium support grids. Option: High-end grids made of synthetic materials for especially demanding panel coatings.



COMPACT AV – pneumatically braked support rollers as standard equipment.
COMPACT – mechanically braked support rollers as optional equipment.

of performance and comfort

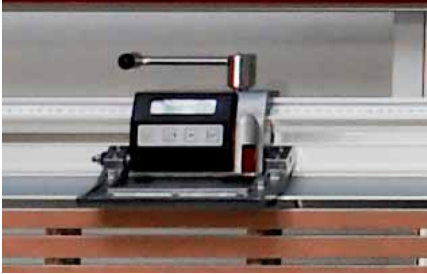

Digital measuring system DMS – for measurements that are accurate to 1/10 mm.



Depth stop for adjustable grooving tools



Grooving device for composite boards

Composite panels – cutting, shaping and designing individually

Composite panels are a modern material for modern architecture, transportation, trade fair construction and shopfitting as well as for displays and many other applications. They can be further processed without any problems on every Striebig COMPACT AV and COMPACT.

The mill-folding technique allows an easy manufacture of formed parts. Hard-metal turnover board profile cutters mill V- and U-shaped grooves into the rear side of the panels. During this procedure, the aluminium cover on the front side and a part of the plastic core remain intact. The low thickness of the remaining material allows edge folding "by hand" afterwards. The groove shape determines the radius of bend.

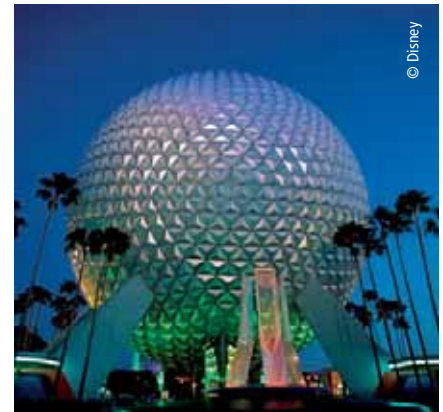

© Disney

Composite boards are used as all-purpose material in architecture and facade engineering. They provide accents and offer manifold decorative possibilities.



Available as accessories: Reversible carbide tipped profile cutters enable product-specific cutting of composite panels.

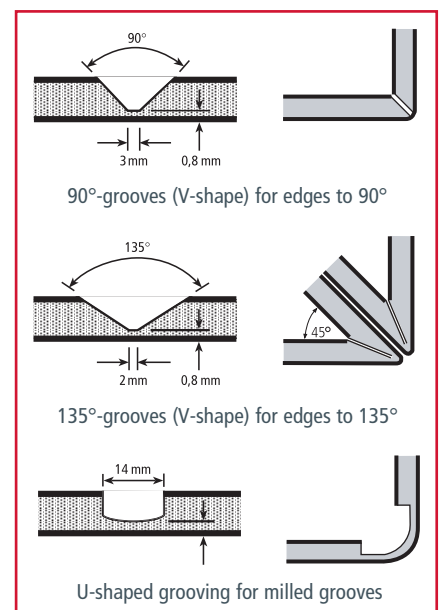

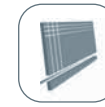

CONTROL EVOLUTION STANDARD COMPACT

Convincing: Dimensions and data of the COMPACT

As a matter of course, our machines come comprehensively equipped ex works. Many details which we include in the standard equipment are rarely found in other machines, even against surcharge. Please compare!

- Powerful TRK dust extraction.** The dust limit value is clearly below 1mg/m³.
- Roller support with up to 17 rollers
- Automatically evading grid
- High-quality saw blade
- Adjustable cutting depth, 9 to 13mm
- Powerful 3.9 kW motor
- Wooden small parts support over the entire length
- Central support with aluminium support grids over the entire length
- Length stop with integrated small parts stop
- Length-adjustable operating lever
- Mirror on the saw beam
- Safe packaging
- CE tested
- Detailed documents
- Swiss made



SWISS LABEL underlines the origin and the quality awareness of goods and services of Swiss origin. STRIEBIG AG is entitled to use this trademark.

**TRK is the abbreviation for "Technische Richt-Konzentrati-on" (Technical target concentration). These values have been applicable since July 1988 and specify the maximum permissible wood dust concentration at the workplace. The TRK-value is 2 mg/m³ total dust based on a working average (shift) of 8 hours.

Connection to an external dust extraction is required. The system used must have an extraction performance of 20 m/sec. in order to meet the TRK specifications.

COMPACT						
Type	Dimensions in mm			Cutting range in mm		
	L	H	W*1	L	Hvert	Hhor
6220	6466	2955	1563	5350	2200	2100
6207	6466	2814	1531	5350	2070	1958
6164	6466	2390	1435	5350	1644	1532
5220	5716	2955	1563	4600	2200	2100
5207	5716	2814	1531	4600	2070	1958
5164	5716	2390	1435	4600	1644	1532
4220	4216	2955	1563	3100	2200	2100
4207	4216	2814	1531	3100	2070	1958
4164	4216	2390	1435	3100	1644	1532
COMPACT AV						
Type	Dimensions in mm			Cutting range in mm		
	L	H	W*1	L	Hvert	Hhor
6220	6796	2955	1583	5350	2200	2100
6207	6796	2814	1551	5350	2070	1958
6164	6796	2390	1455	5350	1644	1532
5220	6046	2955	1583	4600	2200	2100
5207	6046	2814	1551	4600	2070	1958
5164	6046	2390	1455	4600	1644	1532
4220	4546	2955	1583	3100	2200	2100
4207	4546	2814	1551	3100	2070	1958
4164	4546	2390	1455	3100	1644	1532

	COMPACT	COMPACT AV
Weight of the saw	approx. 815 kg	approx. 910 kg
Cutting depth	60mm	60mm
Saw motor rating	3.9 kW	3.9 kW
Saw blade diameter	250mm	250mm
Saw blade bore	30mm *2	30mm *2
Saw blade speed	5250 U/min	5250 U/min
2 extraction connection Ø	100mm	100mm
Wattage	4.8 kW	4.8 kW
Mains connection	3 x 400 V/50 Hz	3 x 400 V/50 Hz
	Special voltages and special frequencies on request	

*1 W1 - for freestanding assembly

*2 with 2 side holes Ø 7mm, radius 21mm

(All details refer to the COMPACT type 6220)

Advice · Sales · Service

Striebig AG
Grossmatte 26
CH-6014 Lucerne
Tel. 0041(0)41 259 53 53
Fax 0041(0)41 259 53 50
www.striebig.com
info@striebig.ch

