

Male Luer Lock Adaptors



Part Number: TSD931-1
Material: Nickel Plated Brass
Thread Size: 5/16-28



Part Number: TSD931-5
Material: White Celcon
Thread Size: 5/16-28



Part Number: TSD931-6
Material: White Celcon
Thread Size: 1/8" NPT



Part Number: TSD931-8
Material: White Celcon
Thread Size: 1/4-32

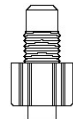

Part Number: TSD931-22
Material: Black Celcon
Thread Size: 1/4-32



Part Number: TSD931-49
Material: White Nylon
Thread Size: 1/4-28



Part Number: TSD931-60
Material: Clear Polypropylene
Thread Size: 1/4-28



Part Number: TSD931-91
Material: Black Delrin®
Thread Size: 1/4-28



Part Number: TSD931-48
Material: Chrome Plated Brass
Thread Size: 5/16-28

Male Luer Lock Adaptors Cont...



Part Number: TSD931-57
Material: Black Nylon
Thread Size: 1/8" NPT

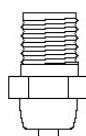

Part Number: TSD931-7
Material: White Polypropylene
Thread Size: 1/4-18 NPT

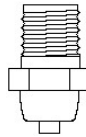

Part Number: TSD931-14
Material: Black polypropylene
Thread Size: 1/4-18 NPT

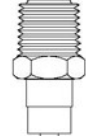

Part Number: 918-006-000
Material: Nickel Plated & Brass
Thread Size: 1/4" NPT



Part Number: TSD931-16
Material: White Celcon
Thread Size: 3.30mm/0.13"



Part Number: TSD931-17
Material: White Celcon
Barb Size: 4.32mm/0.17"

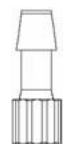

Part Number: TSD931-73
Material: Black Polypropylene
Barb Size: 8.38mm/0.33"

Female Luer Lock Adaptors



Part Number: TSD931-9
Material: Black Celcon
Thread Size: 1/4-32



Part Number: TSD931-31
Material: Nickel Plated Brass
Thread Size: 1/4-32

Female Luer Lock Adaptors Cont...



Part Number: TSD931-37
Material: Stainless Steel
Thread Size: 1/4-32

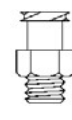

Part Number: TSD931-58
Material: Clear Polypropylene
Thread Size: 1/4-28



Part Number: TSD931-63
Material: Stainless Steel
Thread Size: 10-32

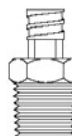

Part Number: TSD931-15
Material: Black Nylon/Celcon
Thread Size: 1/4" NPT



Part Number: TSD931-54
Material: Black Nylon/Celcon
Thread Size: 1/8" NPT

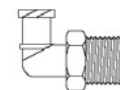

Part Number: TSD931-47
Material: Clear Polypropylene
Thread Size: 1/8-27 NPT

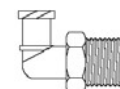

Part Number: TSD931-75
Material: Black Polypropylene
Thread Size: 1/8-27 NPT



Part Number: TSD931-12
Material: White Celcon
Barb Size: 3.81mm/0.15"



Part Number: TSD931-13
Material: White Celcon
Barb Size: 4.32mm/0.17"

“Non –Through” Compression Fittings

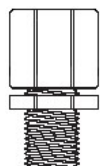

Part Number: TSD1002-17
Material: Black Polypropylene
Thread Size: 1/8" NPT
Tube Size: 3/8" OD

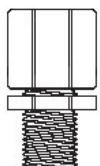

Part Number: TSD1002-18
Material: Black Polypropylene
Thread Size: 1/8" NPT
Tube Size: 1/4" OD

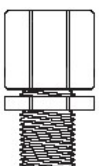

Part Number: TSD1002-38
Material: Black Polypropylene
Thread Size: 1/4" NPT
Tube Size: 1/4" OD

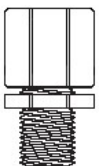

Part Number: TSD1566-5
Material: Black Polypropylene
Thread Size: 1/4" NPT
Tube Size: 3/8" OD

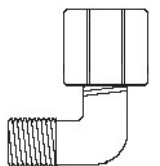

Part Number: TSD1003-16
Material: Black Polypropylene
Thread Size: 1/8" NPT
Tube Size: 1/4" OD

Through Compression Fittings

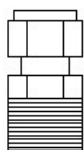

Part Number: P3000042
Material: Stainless Steel
Thread Size: 3/8-18 NPT
Tube Size: 1/4" OD

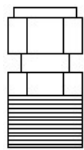

Part Number: P3000043
Material: Stainless Steel
Thread Size: 3/8-18 NPT
Tube Size: 3/8" OD

Through Compression Fittings Cont.....

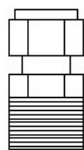

Part Number: P3000045
Material: Stainless Steel
Thread Size: 1/4-18 NPT
Tube Size: 1/4" OD

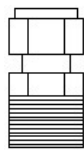

Part Number: P3000046
Material: Stainless Steel
Thread Size: 1/4-18 NPT
Tube Size: 4mm OD

Special Adaptors

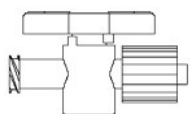

Part Number: TSD931-42
Material: Clear Polycarbonate
Use: Luer Tap



Part Number: TSD931-28
Material: Clear Polypropylene
Use: Syringe Transfer



Part Number: TSD931-296
Material: White Acetal
Use: Euro Cart Transfer Adaptor
(Europe Specific item)

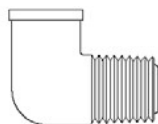

Part Number: TSD918-3
Material: Clear Polypropylene
Use: Male/Female 1/4-18 NPT

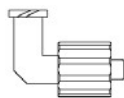

Part Number: TSD931-81
Material: White Nylon
Use: Male/Female Luer Elbow



Part Number: TSD931-82
Material: White Nylon
Use: Male/Female Luer
Extender

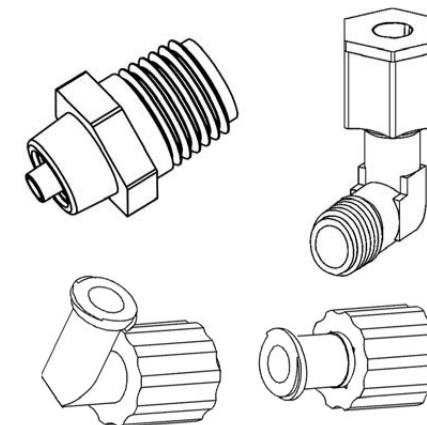

Fluid Adaptor Product Guide



www.adhesivedispensing.co.uk