



www.agrimacuk.com



AGRIA Rough Terrain 4 x 4 Forklift Range





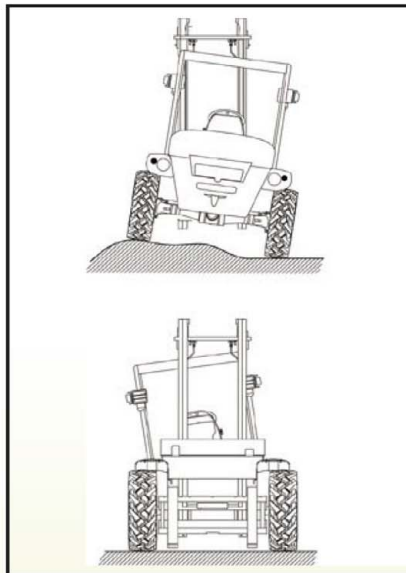
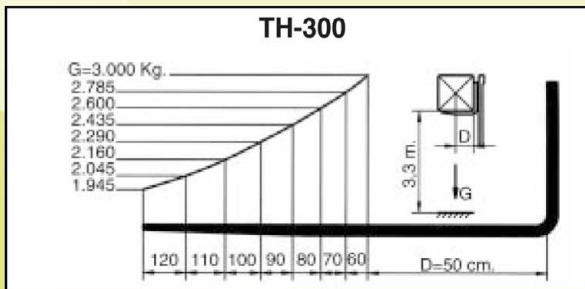
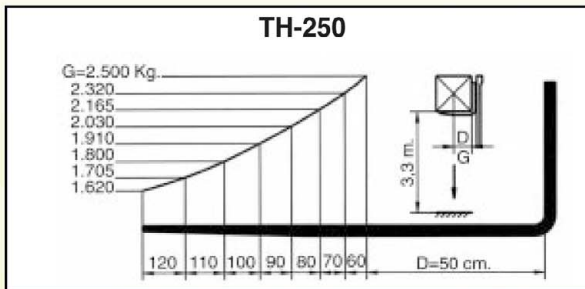
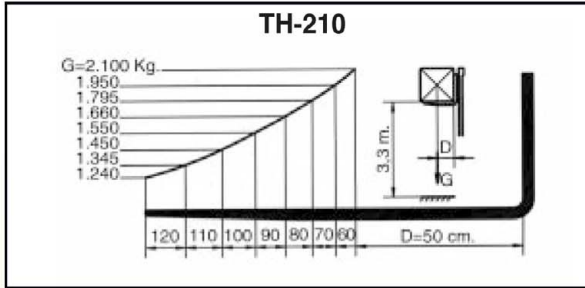
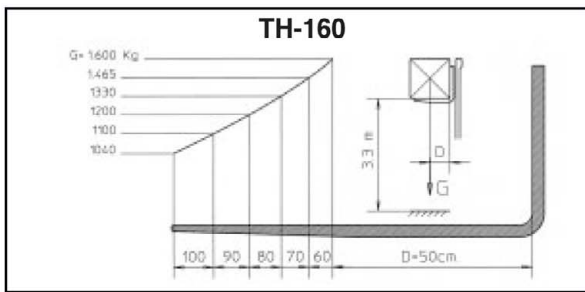

OTROS SISTEMAS
OTHER SYSTEMS • OUTRES SYSTÈMES

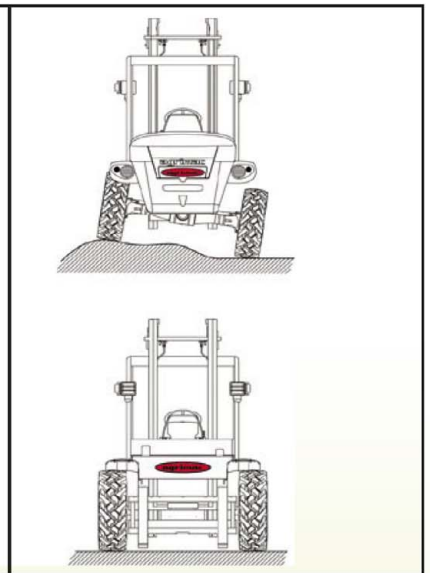

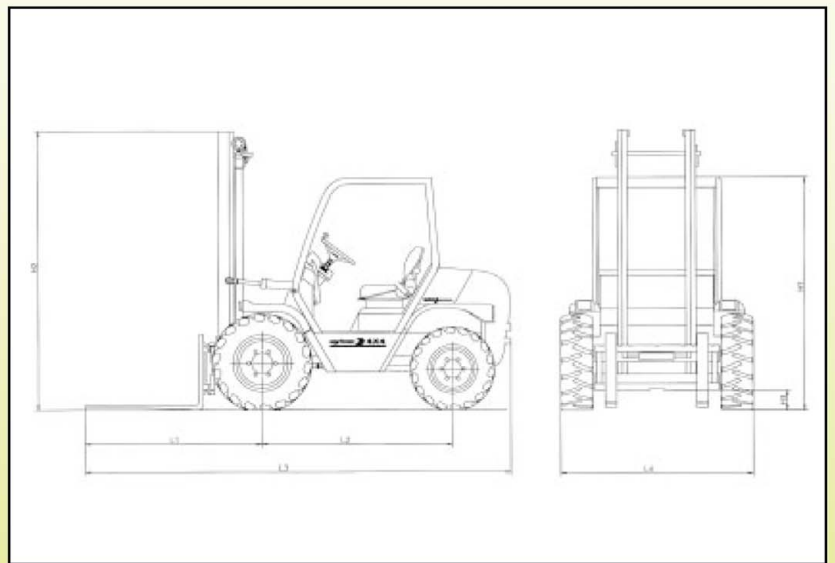

SISTEMA AGRIMAC
AGRIMAC SYSTEM • SYSTÈME AGRIMAC





	TH 160	TH 210	TH 250	TH 300
H1	2.030	2.080	2.290	2.310
H2	Duplex 2,50 m.: 1950 Duplex 3,14 m.: 2250 Duplex 3,60 m. : 2480 Triplex 4 m.: 2050 Triplex 6 m.: 2820	Duplex 3,14 m.: 2250 Duplex 3,60 m. : 2510 Triplex 4 m.: 2080 Triplex 6 m.: 2850	Duplex 3,60 m. : 2510 Triplex 4 m.: 2290 Triplex 5 m.: 2500 Triplex 6 m.: 2850	Duplex 3,60 m. : 2510 Triplex 4 m.: 2290 Triplex 5 m.: 2500 Triplex 6 m.: 2850
H3	200	200	200	230
L1	1.440	1.480	1.765	1.765
L2	1.600	1.700	1.800	1.800
L3	3.480	3.800	4.200	4.315
L4	1.600	1.700	1.800	1.830



TH 160 • CARACTERISTICAS TECNICAS / TECHNICAL DATA / CARACTERISTIQUES TECHNIQUES

 MOTOR	Perkins 3 cilindros Refrigerado por agua, 32 C.V.	 MOTOR	Perkins 3 cylinders Water cooled, 32 C.V.	 MOTEUR	Perkins 3 cylinders Refröissement par eau, 32 C.V.
CAPACIDAD Kg.	1.600	CAPACITY Kg.	1.600	CAPACIDAD Kg.	1.600
TRANSMISIÓN	Hidrostática Rexroth	TRANSMISSION	Hydostatic Rexroth	TRANSMISSION	Hydrostatique Rexroth
TRACCIÓN	4 x 4 con desconectador	TRACCIÓN	4 x 4 with electrohydraulic disconnection	TRACTION	4 x4 avec déconnecteur electrohydraulique
VELOCIDAD	Lenta y rápida: desde 0 hasta 21 Km/h. Sistema de aproximación lenta	SPEEDS	Slow and fast: 0 - 21 Km/h Inching Pedal.	VITESSES	Lent et rapid: 0 - 21 Km/h Système approche lente
FRENOS	Hidrostático a las 4 ruedas	BRAKES	Hydrostatic for 4 wheels	FREINS	Hydrostatic a les 4 roues
RUEDAS	10,5/75-15,3 y 8,0/75-15,3	WHEELS	10,5/75-15,3 and 8,0/75-15,3	ROUES	10,5/75-15,3 et 8,0/75-15,3
PESO Kg.	2.950	WEIGHT Kg.	2.950	POIDS Kg.	2.950
PENDIENTE SUP.	38 %	SURMONTABLE SLOPE	38 %		38 %
OPCIONES MASTIL m.	Dúplex - Triplex	OPTIONS MAST m.	Dúplex - Triplex	OPTIONS MÂT m.	Dúplex - Triplex



TH 210 • CARACTERISTICAS TECNICAS / TECHNICAL DATA / CARACTERISTIQUES TECHNIQUES

 MOTOR	Perkins 4 cilindros Refrigerado por agua, 43 C.V.	 MOTOR	Perkins 4 cylinders Water cooled, 43 C.V.	 MOTEUR	Perkins 4 cylinders Refröissement par eau, 43 C.V.
CAPACIDAD Kg.	2.100	CAPACITY Kg.	2.100	CAPACIDAD Kg.	2.100
TRANSMISIÓN	Hidrostática con caudal variable	TRANSMISSION	Hydostatic Rexroth	TRANSMISSION	Hydrostatique Rexroth
TRACCIÓN	4 x 4 con desconectador	TRACCIÓN	4 x 4 with electrohydraulic disconnection	TRACTION	4 x4 avec déconnecteur electrohydraulique
VELOCIDAD	Lenta y rápida: desde 0 hasta 22 Km/h. Sistema de aproximación lenta	SPEEDS	Slow and fast: 0 - 22 Km/h Inching Pedal.	VITESSES	Lent et rapid: 0 - 22 Km/h Système approche lente
FRENOS	Hidrostático a las 4 ruedas	BRAKES	Hydrostatic for 4 wheels	FREINS	Hydrostatic a les 4 roues
RUEDAS	11,50/80-15,3 y 10,0/75-15,3	WHEELS	11,50/80-15,3 and 10,0/75-15,3	ROUES	11,50/80-15,3 et 10,0/75-15,3
PESO Kg.	3.800	WEIGHT Kg.	3.800	POIDS Kg.	3.800
PENDIENTE SUP.	38 %	SURMONTABLE SLOPE	38 %		38 %
OPCIONES MASTIL m.	Dúplex - Triplex	OPTIONS MAST m.	Dúplex - Triplex	OPTIONS MÂT m.	Dúplex - Triplex

TH 250 • CARACTERISTICAS TECNICAS / TECHNICAL DATA / CARACTERISTIQUES TECHNIQUES

 MOTOR	Deutz 4 cilindros Refrigerado por aire, 60 C.V.	 MOTOR	Deutz 4 cylinders Air cooled, 60 C.V.	 MOTEUR	Deutz 4 cylinders Refröissement par air, 60 C.V.
CAPACIDAD Kg.	2.500	CAPACITY Kg.	2.500	CAPACIDAD Kg.	2.500
TRANSMISIÓN	Hidrostática Rexroth con caudal variable	TRANSMISSION	Hydostatic Rexroth with variable flow	TRANSMISSION	Hydrostatique Rexroth avec débit variable
TRACCIÓN	4 x 4 con desconectador	TRACCIÓN	4 x 4 with electrohydraulic disconnection	TRACTION	4 x4 avec déconnecteur electrohydraulique
VELOCIDAD	24 Km/h. Sistema de aproximación lenta	SPEEDS	Slow and fast: 0 - 24 Km/h Inching Pedal.	VITESSES	Lent et rapid: 0 - 24 Km/h Système approche lente
FRENOS	Hidrostático a las 4 ruedas	BRAKES	Hydrostatic for 4 wheels	FREINS	Hydrostatic a les 4 roues
RUEDAS	11,5/80-15,3	WHEELS	11,5/80-15,3	ROUES	11,5/80-15,3
PESO Kg.	3.950	WEIGHT Kg.	3.950	POIDS Kg.	3.950
PENDIENTE SUP.	38 %	SURMONTABLE SLOPE	38 %	INCLINATION SURMONTABLE	38 %
OPCIONES MASTIL m.	Dúplex - Triplex	OPTIONS MAST m.	Dúplex - Triplex	OPTIONS MÂT m.	Dúplex - Triplex

TH 300 • CARACTERISTICAS TECNICAS / TECHNICAL DATA / CARACTERISTIQUES TECHNIQUES

 MOTOR	Deutz 4 cilindros Refrigerado por aire, 60 C.V.	 MOTOR	Deutz 4 cylinders Air cooled, 60 C.V.	 MOTEUR	Deutz 4 cylinders Refröissement par air, 60 C.V.
CAPACIDAD Kg.	3.000	CAPACITY Kg.	3.000	CAPACIDAD Kg.	3.000
TRANSMISIÓN	Hidrostática Rexroth con caudal variable	TRANSMISSION	Hydostatic Rexroth with variable flow	TRANSMISSION	Hydrostatique Rexroth avec débit variable
TRACCIÓN	4 x 4 con desconectador	TRACCIÓN	4 x 4 with electrohydraulic disconnection	TRACTION	4 x4 avec déconnecteur electrohydraulique
VELOCIDAD	24 Km/h. Sistema de aproximación lenta	SPEEDS	Slow and fast: 0 - 24 Km/h Inching Pedal.	VITESSES	Lent et rapid: 0 - 24 Km/h Système approche lente
FRENOS	Hidrostático a las 4 ruedas	BRAKES	Hydrostatic for 4 wheels	FREINS	Hydrostatic a les 4 roues
RUEDAS	12,0/75-18	WHEELS	12,0/75-18	ROUES	12,0/75-18
PESO Kg.	4.300	WEIGHT Kg.	4.300	POIDS Kg.	4.300
PENDIENTE SUP.	38 %	SURMONTABLE SLOPE	38 %	INCLINATION SURMONTABLE	38 %
OPCIONES MASTIL m.	Dúplex - Triplex	OPTIONS MAST m.	Dúplex - Triplex	OPTIONS MÂT m.	Dúplex - Triplex

CONTACT AGRIMAC (UK) LTD FOR FURTHER INFORMATION & PRICES

t: 01206 795 111 f: 01206 580 799 e: info@agrimacuk.com www.agrimacuk.com

11 Grange Farm Road, Whitehall Industrial Estate, Colchester, Essex CO2 8JW