



Panel Product Range



Click on a **better** solution

Value Added Assembly

IMO Value Added Assembly Division will help you to:

- **Reduce your stock level**
- **Reduce cost**
- **Ensure quality**
- **Increase productivity**

Are you looking for a supplier for your Assemblies who can offer:

- Access to a wide range of products
- Extended range of DIN terminals and accessories
- Relay and sockets, MCBs, power supplies, timers, contactors, signal interface units.
- Standard or custom marker solutions for DIN terminals
- Flexible packing facilities for individual or volume packing

IMO through its Assembly Division can provide Value Added Assembly solutions built to customer specification whether you are looking for prototypes, one-off projects, or small to large volume requirements with regular deliveries, IMO can offer you a solution.

As a world recognised manufacturer of electrical components, IMO have a wide range of connection, power, control and interface products readily available from stock and are always looking forward to the next challenge.

Your Assembly can be as simple as 2 DIN terminals on a small piece of rail, to multiple products on DIN-rail lengths up to 2m; and if required IMO have a range of standard enclosures which are available to accommodate your units, or we can design a custom solution with you.

Challenge us and tell us about your Assembly needs and see what solution we can propose.

To save time and money call us today with your drawings, photos and specifications.

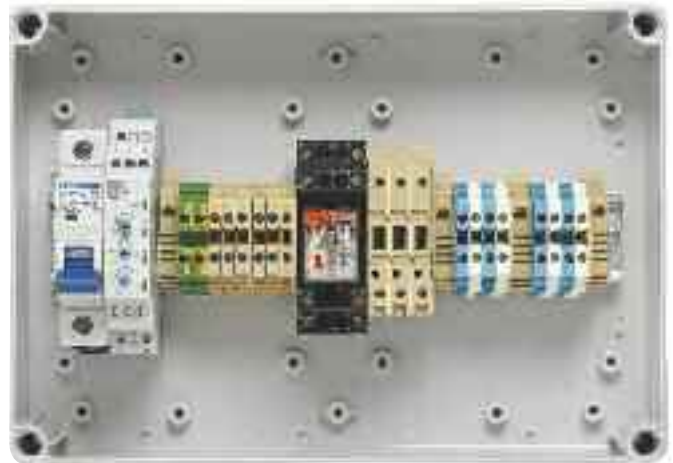

Push Buttons	Cam Switches	Enclosures	Power Supplies	DIN Rail Timers	Timers	Contactors
						

The complete Panel solution

IMO's range of Panel products continues to deliver innovation and efficiency worldwide, and is where technology and engineering excellence come together.

IMO's Panel range has been specifically designed to meet the demanding needs of today's panel builders and engineers whose requirements can range from a simple DIN Terminal through to a complete panel solution.

IMO's products allow panel builders globally to deliver significant advances through greater efficiency, reliability and performance. There by increasing their competitive advantage and delivering the optimum panel solution.

When purchasing from IMO you can be confident that over 40 years experience servicing the Panel Builder market has gone into the design and development of the IMO range.

Listed in this brochure are just some of the most popular products from the IMO Panel range. If you can't find what you are looking for, please contact the IMO Sales Desk on +44 (0)20 8452 6444 who will be happy to assist you with your enquiry.

DIN Rail Terminals



Relays & Sockets



Power Supplies



Enclosed Starters	Switch Fuses	Isolators	Motor Circuit Breakers	Miniature Circuit Breakers	DIN Rail Terminals	Relays & Sockets

Push Buttons



Go to www.imopc.com for full details

- IP67/IP65 Protection
- Opaque or illuminated
- Aluminium, Black or Chrome Bezel
- Snap-on contact blocks
- Colour coded contacts
- International approvals including UL approved products
- Maintained or spring return
- Assembled control stations
- 1/2/3 hole Push Button enclosure
- Key operated switch
- Labelling accessories

Emergency Stop Buttons

Part Number	Description
BS3P3RED-0	Emergency Stop Push Button 28mm, Red With White O, Twist To Release, Black Bezel
BS3P45RED	Emergency Stop Push Button 38mm, Red
BS3P44S3	Emergency Stop Push Button 40mm, Red Key Release
BC3P34RED-0	Emergency Stop Push Button 40mm, Red With White O, Twist To Release, Chrome Bezel
BS3P34RED-0	Emergency Stop Push Button 40mm, Red With White O, Twist To Release, Black Bezel
BS3P44RED	Emergency Stop Push Button 30mm, Red
B3-SK-YELLOW	Emergency Stop Shroud 40mm Max Button Diameter
BG10P45-11	Emergency Stop Station 40mm Red Button, Yellow Face, 1N/O And 1N/C Contacts
BG10P34P-02	Emergency Stop Station 70mm Twist To Release Red Button, Yellow Enclosure Face, 2 N/C Contacts
BG10P34P-11	Emergency Stop Station 70mm Twist To Release Red Button, Yellow Enclosure Face, 1N/O 1N/C Contacts

Push Buttons / Rotary Knobs

Part Number	Description
BS3P14RED-0	Mushroom Head Push Button 40mm, Red With White O
BS3DBLA-ARROW	Push Button Spring Return Black With White Arrow Black Bezel
B3DBLACK	Push Button Spring Return Black, Aluminium Bezel
BS3DBLACK	Push Button Spring Return Black, Black Bezel
B3DBLUE	Push Button Spring Return Blue, Aluminium Bezel
BS3DBLUE	Push Button Spring Return Blue, Black Bezel
BS3DGRE-I	Push Button Spring Return Green With White I Black Bezel
BS3DGREEN	Push Button Spring Return Green, Black Bezel
BS3DRED	Push Button Spring Return Red, Black Bezel
B3DRED	Push Button Spring Return Red, Aluminium Bezel
B3P1RED	Push Button Spring Return 28mm Red, Aluminium Bezel
BS3DYELLOW	Push Button Spring Return Yellow, Black Bezel
B3KN2	Rotary Knob, 2 Position Maintained 60deg, Aluminium Bezel
BC3KN2	Rotary Knob, 2 Position Maintained 60deg, Chrome Bezel
BS3KN2	Rotary Knob, 2 Position Maintained 60deg, Black Bezel
B3KN3	Rotary Knob, 3 Position Maintained 60deg, Aluminium Bezel
BS3KN3	Rotary Knob, 3 Position Maintained 60deg, Black Bezel
BS3KN9	Rotary Knob, 2 Position Maintained 120deg, Black Bezel
BS3KN10	Rotary Knob, 2 Position Maintained 90deg, Black Bezel

Illuminated Push Buttons

Part Number	Description
B3DLRED	Illuminated Push Button Spring Return Red, Aluminium Bezel
B3DLGREEN	Illuminated Push Button Spring Return Green, Aluminium Bezel
B3DLYELLOW	Illuminated Push Button Spring Return Yellow, Aluminium Bezel
B3DLBLUE	Illuminated Push Button Spring Return Blue, Aluminium Bezel
BS3KL2	Illuminated Rotary Knob 2 Position Maintained, Black Bezel
BS3DT-GRE/RED	Double Actuation Push Button Green - Red, Black Bezel
BC3DT-GRE/RED	Double Actuation Push Button Green - Red, Chrome Bezel
B3DT-GRE/RED	Double Actuation Push Button Green - Red - Aluminium Bezel

Transparent Lens Caps

Part Number	Description
B3RFGREEN	Lens Cap, Green, Fresnel Lens
B3RFRED	Lens Cap, Red, Fresnel Lens
B3RGREEN	Lens Cap, Green
B3RRRED	Lens Cap, Red

B(S)3D..	Maintained B(S)3DLBR..	B(S)3DT..	B(S)3P1..	B(S)3SAR..	B(S)3KN	B(S)3KRN	B3KL2 Rotary Knob
							

Contact Block



Part Number	Description
B3T01	1N/C Clips Onto B3S/B3M
B3T10	1N/O Clips Onto B3S/B3M
B4TU11	1N/O And 1N/C, for BG... Enclosures
B4TU10F	1N/O With Lamp Holder, for BG... Enclosures
B4TU10	1N/O, for BG... Enclosures
B4TU02	2N/C, for BG... Enclosures
B4TU20	2N/O, for BG... Enclosures
BG1	Pushbutton Enclosure 1 Hole Grey
BG1YEL	Pushbutton Enclosure 1 Hole Yellow
BG2	Pushbutton Enclosure 2 Hole Grey
BG3	Pushbutton Enclosure 3 Hole Grey
J7049	Pushbutton Collar tightening tool

Pilot Lights



Part Number	Description
LMB-110-GREEN	LED Pilot Light 110VAC Green
LMB-110-RED	LED Pilot Light 110VAC Red
LMB-110-WHITE	LED Pilot Light 110VAC White
LMB-110-YELLOW	LED Pilot Light 110VAC Yellow
LMB-230-GREEN	LED Pilot Light 230VAC Green
LMB-230-RED	LED Pilot Light 230VAC Red
LMB-230-WHITE	LED Pilot Light 230VAC White
LMB-230-YELLOW	LED Pilot Light 230VAC Yellow
LMB-24-BLUE	LED Pilot Light 24V AC/DC Blue
LMB-24-GREEN	LED Pilot Light 24V AC/DC Green
LMB-24-RED	LED Pilot Light 24V AC/DC Red
LMB-24-WHITE	LED Pilot Light 24V AC/DC White
LMB-24-YELLOW	LED Pilot Light 24V AC/DC Yellow

Quick Chart Selection

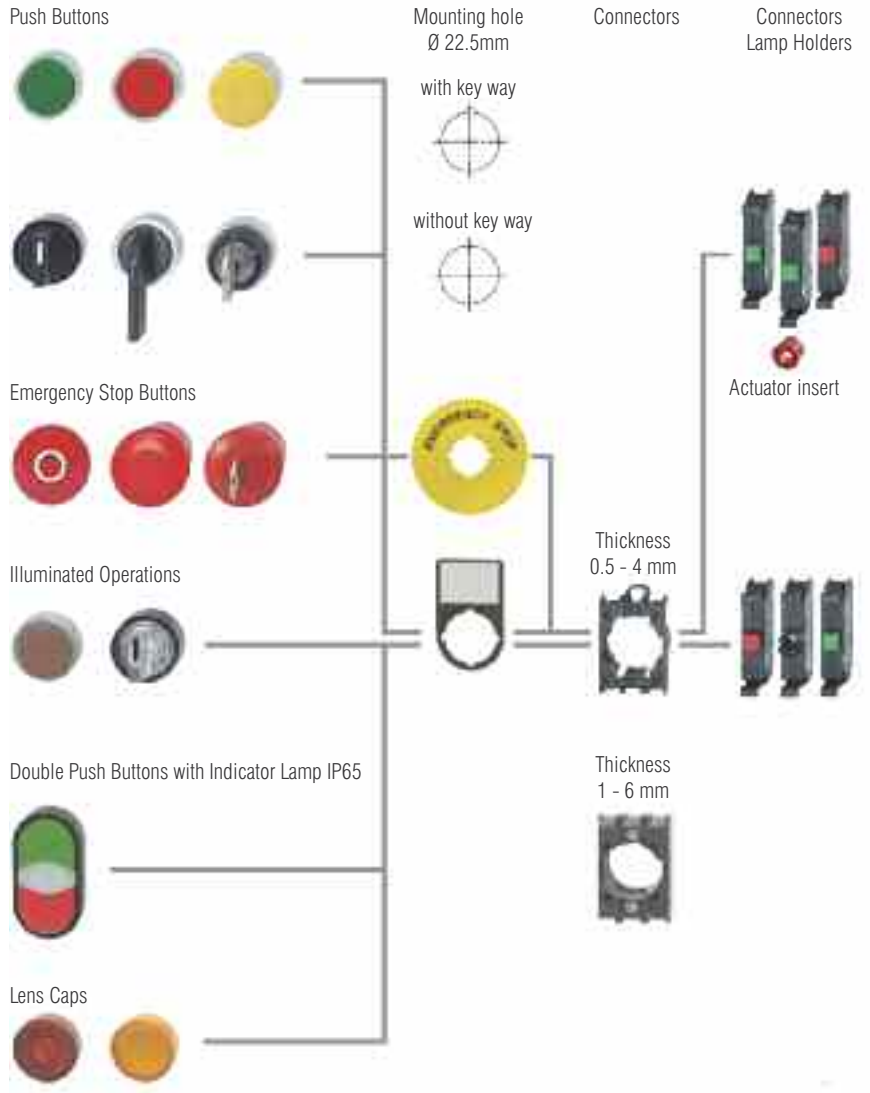

Listed are some of our most popular products. A dedicated catalogue is available from IMO which includes all options for Push Buttons



B3RF..	B(S)3P34RED-O	BS3P44RED	BS3P44S3	B(S)3DL..	B3-SK-YELLOW	BG1	B4TU11.. Contact Block

Cam Switches



Go to www.imopc.com for full details

IMO's range of Cam Switches incorporates a unique building block system that allows for any number of switch variants to be built and supplied to the customer. Such is the flexibility of the Cam Switches, that they can be utilised in countless applications including mains/motor switching and control and instrumentation circuits.

The standard contact rating is 20A, although higher ratings are available on request and the new switches have double interruption per pole and two contacts per cell. Standard units incorporate a 22.5mm central fixing for panel mounting. The switch body and actuators are supplied separately to provide a choice of four different set up configurations. Connection from actuator to switch body is made through a solid aluminium shaft.

Manufactured in accordance with IEC 60947-3, the new Cam Switches carry an IP65 rating and have 'finger proof' screw terminals. The switch body is supplied complete with legend plate and all units are UL/cUL approved.



Part Number	Description
CS20A-A1	1 Pole 2 Position 20A, On/Off With Legend Plate
CS20A-A2	2 Pole 2 Position 20A, On/Off With Legend Plate
CS20A-A4	4 Pole 2 Position 20A, On/Off With Legend Plate
CS20A-A8	8 Pole 2 Position 20A, On/Off With Legend Plate
CS20A-ST31	1 Pole 3 Position 20A, Step With Legend Plate
CS20A-ST33	3 Pole 3 Position 20A, Step With Legend Plate
CS20A-ST42	2 Pole 4 Position 20A, Step With Legend Plate
CS20A-ST45	5 Pole 4 Position 20A, Step With Legend Plate
CS20A-ST51	1 Pole 5 Position 20A, Step With Legend Plate
CS20A-ST52	2 Pole 5 Position 20A, Step With Legend Plate
CS20A-ST61	1 Pole 6 Position 20A, Step With Legend Plate
CS20A-U1	1 Pole 3 Position 20A, C/O With Legend Plate
CS20A-U2	2 Pole 3 Position 20A, C/O With Legend Plate
CS20A-U3	3 Pole 3 Position 20A, C/O With Legend Plate
CS20A-U4	4 Pole 3 Position 20A, C/O With Legend Plate
CS20A-U6	6 Pole 3 Position 20A, C/O With Legend Plate
CS20A-W2	2 Pole 2 Position 20A, C/O Without Off With Legend Plate
CS20A-W3	3 Pole 2 Position 20A, C/O Without Off With Legend Plate
CS20A-W4	4 Pole 2 Position 20A, C/O Without Off With Legend Plate
CS20A-W8	8 Pole 2 Position 20A, C/O Without Off With Legend Plate
RB2	Cam Switch Handle, Round Bezel
RBK2	Cam Switch Handle, Round Bezel, Key Operated
SP2	Cam Switch Handle, Escutcheon Plate
SPK2	Cam Switch Handle, Escutcheon Plate, Key Operated

Off-On Switch

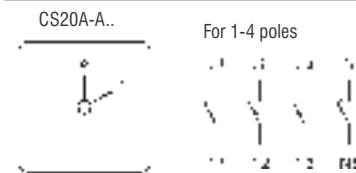

Change over switches, with off

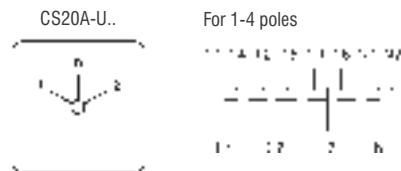

Change over switches, without off

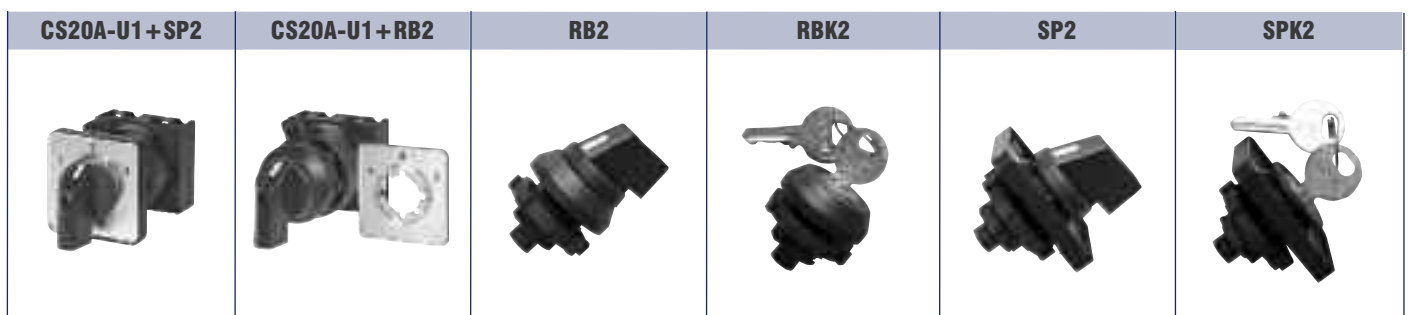
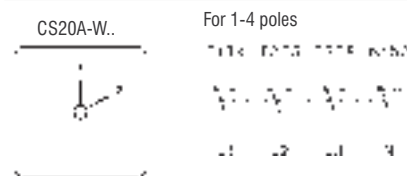

Enclosures



Go to www.imopc.com for full details

- ABS Body
- Plain sided walls
- Colour RAL 7035 – Light grey
- Circuit board slots in base
- IP66-67
- Plastic screws captive once fitted
- Pre-moulded fixing points in base
- Suitable for housing electronic terminal blocks, electro-mechanical components and industrial equipment
- Polycarbonate versions (144EP range) are UL and cUL approved



Accessories

Part Number	Description
144E0001	Enclosure, ABS (75 X 125 X 75)
144E0002	Enclosure, ABS (125 X 125 X 75)
144E0003	Enclosure, ABS (125 X 125 X 100)
144E0004	Enclosure, ABS (125 X 175 X 75)
144E0005	Enclosure, ABS (125 X 175 X 100)
144E0006	Enclosure, ABS (125 X 175 X 125)
144E0007	Enclosure, ABS (175 X 175 X 100)
144E0008	Enclosure, ABS (175 X 175 X 125)
144E0009	Enclosure, ABS (175 X 175 X 150)
144E0010	Enclosure, ABS (175 X 250 X 100)
144E0011	Enclosure, ABS (175 X 250 X 150)
144E1008	Enclosure, ABS (120 X 200 X 86)
144E1010	Enclosure, ABS (230 X 300 X 111)
144E2002	Transparent Lid Enclosure, ABS (125 X 125 X 75)
144E2003	Transparent Lid Enclosure, ABS (125 X 175 X 100)
144E2004	Transparent Lid Enclosure, ABS (125 X 175 X 150)
144EP0002	Enclosure, Polycarbonate (125 X 125 X 75)
144EP0004	Enclosure, Polycarbonate (125 X 175 X 75)
144EP0005	Enclosure, Polycarbonate (125 X 175 X 100)
144EP0006	Enclosure, Polycarbonate (125 X 175 X 125)
144EP0008	Enclosure, Polycarbonate (175 X 175 X 125)
144EP0010	Enclosure, Polycarbonate (175 X 250 X 100)
144EP0011	Enclosure, Polycarbonate (175 X 250 X 150)

Part Number	Description
144A0001	Hinge Pair
144A0002	Fastening lug, 4 off
144A0003	Inspection window 2 mod.
144A0004	Inspection window 4 mod.
144A0005	Inspection window 6 mod.
144A0006	Inspection window 8 mod.
144A0007	Inspection window 10 mod.
144A0008	Inspection window 12 mod.
144A0009	Vent device IP34
144A0010	Vent device IP44
144R0001	Din Rail For 144E0001
144R0002	Din Rail For 144E0002, 0003
144R0004	Din Rail For 144E0004, 0005, 0006, 0007, 0008 & 0009
144R0010	Din Rail For 144E0010, 0011

Distribution Boxes

Part Number	Description
E-04W	4 Way IP65 Enclosure, 127x200x120, transparent Door
E-08W	8 Way IP65 Enclosure, 200x200x120, transparent Door
E-12W	12Way IP65 Enclosure 318x258x142, Transparent Door
E-24W	24Way IP65 Enclosure 318x383x142, Transparent Door
E-Lock	Enclosure Lock To Suit E-xxW Enclosures



Power Supplies



Go to www.imopc.com for full details



IMO's DPS range of AC/DC Din Rail mounted power supplies have been specifically designed for the control and automation market. Offering the benefits of slimline construction, universal input, AC/DC operation and the security of IMO's 3-year warranty, the DPS range provides multiple choices for all low power electrical or electronic devices commonly used in automation machinery.

The DPS range provides a reliable power source for components such as sensors, relays, contactors, timers, temperature controllers, PLC's, process controllers and HMI's, all of which are also available from IMO.

Offering high efficiency up to 89%, the DPS range is short-circuit protected and has its own integrated internal input filter. The 5W to 18W units are supplied in slimline 22.5mm wide plastic enclosures, whilst the 30W and 60W unit are only 40.5mm and the 120W is 63.5mm. The range is completed with out 240W and 480W units which are supplied in metal enclosures 83mm and 175mm wide respectively. Of this range the models up to 120 are UL certified for class 2 environments.

The DPS-1 supplies offer the advantage of a universal input voltage range, of 85V – 265VAC and are supplied as standard with a 24VDC output. Outputs of 5V, 12V and 48V are also available together with a redundancy module, please contact IMO to discuss your requirements.



actual size

new

Part Number	Description
DPS-1-005-24DC	Power Supply 90-265AC input, 24VDC Output, 5W 0.21A
DPS-1-010-24DC	Power Supply 90-265AC input, 24VDC Output, 10W 0.42A
DPS-1-018-24DC	Power Supply 90-265AC input, 24VDC Output, 18W 0.75A
DPS-1-030-24DC	Power Supply 85-264AC input, 24VDC Output, 30W 1.25A
DPS-1-060-24DC	Power Supply 85-264AC input, 24VDC Output, 60W 2.5A
DPS-1-120-24DC	Power Supply 93-264AC input, 24VDC Output, 120W 5A
DPS-1-240-24DC	Power Supply 93-264AC input, 24VDC Output, 240W 10A
DPS-1-480-24DC	Power Supply 90-264AC input, 24VDC Output, 480W 20A
DPS-3-120-24DC	Power Supply 340-575AC input, 24VDC output, 120W 5A
DPS-3-240-24DC	Power Supply 340-575AC input, 24VDC output, 240W 10A
DPS-3-480-24DC	Power Supply 340-575AC input, 24VDC output, 480W 20A
DPS-3-960-24DC	Power Supply 340-575AC input, 24VDC output, 960W 40A
MPS-1-010-24DC	Modular power supply 90-265AC input, 24VDC output, 10W 0.42A
MPS-1-024-24DC	Modular power supply 90-265AC input, 24VDC output, 24W 1A
MPS-1-036-24DC	Modular power supply 90-265AC input, 24VDC output, 36W 1.5A
MPS-1-060-24DC	Modular power supply 90-265AC input, 24VDC output, 60W 2.5A
MPS-1-100-24DC	Modular power supply 90-265AC input, 24VDC output, 100W 3.8A



Timers



Go to www.imopc.com for full details

- 17.5mm DIN Rail mount range
- 48 DIN panel mount/plug in range
- Multifunction
- On / Off / True Off delay
- Asymmetrical
- Star delta
- 12 -240VAC/DC option



IMO's comprehensive range of DIN Rail mountable Timers delivers up-to-the-minute technology. Ranging from the simple single-function through to the multi-function timer with display, these timers are being used daily in all types of applications and industries. The ultra compact design and top-mounted terminals make installation easy, even in the tightest of panels, providing customers with a solution at minimal cost. Wide input voltage capability allow these products to be installed in applications across the world.

IMO's range of Panel mount / Plug In Timers provide users with with a range of settings and functionality and timing ranges between 0.1 sec and 60hrs. Other key featuers include indication for time range, time up and power on timing. IMO Sockets are available to complement the panel mounting facility thereby giving the installer the option of Din rail mounting, surface mounting or printed-circuit board mounting.

IMO Timers are always of the highest quality, and are backed with a Three Year Warranty. If you require a timer that is not listed here please contact IMO to receive information on the full range.

DIN Rail Mountable

Part Number	Description
TDM10	Multifunction DIN Timer 10 Func, 24-230V AC/DC, SPCO
TDAS	Multifunction Asymmetrical DIN Timer, 24-230V AC/DC, SPCO
TDSD1	Star/Delta DIN Timer 20-500ms, 230-400VAC, DPCO
TDA	True Off Delay 3min, 24V AC/DC, 110-240VAC, SPCO
TDMD-X	Multifunction DIN Timer 4 Functions, 12-24V AC/DC, SPCO

Panel Mount / Plug-In

Part Number	Description
TA11-A100-230AC	Timer 0.05s-60hr DPCO Multi/F 5A, 11pin octal 100-230VAC
TA11-A24AC/DC	Timer 0.05s-60hr DPCO Multi/F 5A, 11pin octal 24VAC/DC
TA8-A100-230AC	Timer 0.05s-60hr DPCO On-DELAY 5A, 8pin octal 100-230VAC
TA8-A24AC/DC	Timer 0.05s-60hr DPCO On-DELAY 5A, 8pin octal, 24VAC/DC
TA8-DA100-230AC	Timer 0.1m-12m DPCO True Off-DELAY 5A, 8pin octal, 100-230VAC
TA8-SA100-230AC	Timer 0.05s-60hr SPCO On-DELAY 5A, 8pin octal, 100-230VAC
TA8-TA100-230AC	Timer 0.05s-60hr DPCO Asymmetrical 5A, 8pin octal, 100-230VAC
TY4-12DC	14 Pin Plug In On Delay Timer, 0.1s-100h, 12VDC
TY4-24DC	14 Pin Plug In On Delay Timer, 0.1s-100h, 24VDC
TY4-24AC	14 Pin Plug In On Delay Timer, 0.1s-100h, 24VAC
TY4-115AC	14 Pin Plug In On Delay Timer, 0.1s-100h, 115VAC
TY4-230AC	14 Pin Plug In On Delay Timer, 0.1s-100h, 230VAC

actual size



TDM10



TDAS



TDSD1



TDMD-X



Contactors 4-400kW



Go to www.imopc.com for full details

Contactors features include:

- 10A up to 1200A 400V AC3
- Minimum size & Maximum performance
- AC and DC operated
- Ambient temperature -40°C to +90°C
- Din rail mounting up to 115A AC3
- Bifurcated aux. contacts
- High contact reliability
- 4 pole full rated version available
- Easy coil swap
- Coil connection top & bottom*

Mini Contactor Features include:

- Up to 5.5kW 400V AC3
- Screw terminals option
- Solder pins option
- Fast on tab connection option



actual size

Miniature contactor range MR07 - MB09 - MB12

Part Number	Description
MR07-S-22230	Mini Relay 4P (2NO/2NC), 3A AC15, 230VAC coil
MB09-S-10=24	Mini Cont 3P Open 4kW 9A AC3, 1NO Aux, 24VDC coil
MB09-S-1048	Mini Cont 3P Open 4kW 9A AC3, 1NO Aux, 48VAC coil
MB09-S-10110	Mini Cont 3P Open 4kW 9A AC3, 1NO Aux, 110VAC coil
MB09-S-01230	Mini Cont 3P Open 4kW 9A AC3, 1NC Aux, 230VAC coil
MB09-S-10230	Mini Cont 3P Open 4kW 9A AC3, 1NO Aux, 230VAC coil
MB09-P-10=24	Mini Cont 3P Open 4kW 9A AC3, 1NC Aux, PCB mount, 24VDC coil
MB12-S-10=24	Mini Cont 3P Open 5.5kW 12A AC3, 1NO Aux, 24VDC coil

Contactors range MC10N to MC22N

*(coil connection top and bottom)

MC10N-S-1024DC	Cont 3P Open 4kW 10A AC3, 1NO Aux, 24VDC coil
MC10N-S-10110AC	Cont 3P Open 4kW 10A AC3, 1NO Aux, 110VAC coil
MC10N-S-10230AC	Cont 3P Open 4kW 10A AC3, 1NO Aux, 230VAC coil
MC14N-S-1024AC	Cont 3P Open 5.5kW 14A AC3, 1NO Aux, 24VAC coil
MC14N-S-10230AC	Cont 3P Open 5.5kW 14A AC3, 1NO Aux, 230VAC coil
MC14N-S-10400AC	Cont 3P Open 5.5kW 14A AC3, 1NO Aux, 400VAC coil
MC18N-S-1024DC	Cont 3P Open 7.5kW 18A AC3, 1NO Aux, 24VDC coil
MC18N-S-10230AC	Cont 3P Open 7.5kW 18A AC3, 1NO Aux, 230VAC coil
MC22N-S-10110AC	Cont 3P Open 11kW 22A AC3, 1NO Aux, 110VAC coil
MC22N-S-10230AC	Cont 3P Open 11kW 22A AC3, 1NO Aux, 230VAC coil

Part Number	Description
MC10N-S-00-22110AC	Cont 4P (2NO/2NC) 4kW 10A AC3, 110VAC coil
MC10N-S-00-31110AC	Cont 4P (3NO/1NC) 4kW 10A AC3, 110VAC coil
MC10N-S-00-40230AC	Cont 4P Open 4kW 10A AC3, 230VAC coil
MC18N-S-00-40110AC	Cont 4P Open 7.5kW 18A AC3, 110VAC coil

Contactors range MC24 to MC115

Part Number	Description
MC24-S-00110	Cont 3P Open 11kw 24A AC3, 110VAC coil
MC24-S-00230	Cont 3P Open 11kw 24A AC3, 230VAC coil
MC24-S-00=24	Cont 3P Open 11kw 24A AC3, 24VDC coil
MC32-S-00110	Cont 3P Open 15kw 32A AC3, 110VAC coil
MC32-S-00230	Cont 3P Open 15kw 32A AC3, 230VAC coil
MC32-S-0024	Cont 3P Open 15kw 32A AC3, 24VAC coil
MC40-S-00230	Cont 3P Open 18.5kw 40A AC3, 230VAC coil
MC50-S-00400	Cont 3P Open 22kw 50A AC3, 400VAC coil
MC62-S-00110	Cont 3P Open 30kw 62A AC3, 110VAC coil
MC74-S-00230	Cont 3P Open 37kw 74A AC3, 230VAC coil
MC90-S-00230	Cont 3P Open 45kw 74A AC3, 230VAC/DC coil
MC90-S-00110	Cont 3P Open 45kw 74A AC3, 110VAC/DC coil
MC115-S-00230	Cont 3P Open 55kw 74A AC3, 230VAC/DC coil

More Contactors available on-line, please visit www.imopc.com

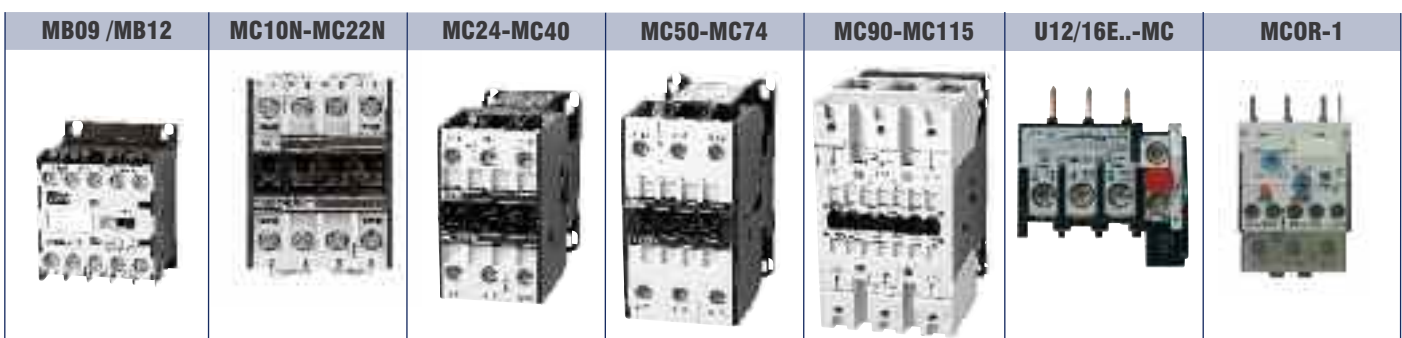

Capacitor switching contactors for reactive or non-reactive capacitor banks

Part Number	Description
MC18N-K-10400AC	12.5kVar Capa. Sw. Cont. 3P, 1NO Aux. 400VAC coil
MC18N-K-10230AC	12.5kVar Capa. Sw. Cont. 3P, 1NO Aux. 230VAC coil
MC32-K-00110	25kVar Capa. Sw. Contactor, 3P, 110VAC coil
MC32-K-00230	25kVar Capa. Sw. Contactor, 3P, 230VAC coil
MC32-K-00400	25kVar Capa. Sw. Contactor, 3P, 400VAC coil
MC50-K-00400	33.3kVar Capa. Sw. Contactor, 3P, 400VAC coil
MC62-K-00110	50kVar Capa. Sw. Contactor, 3P, 110VAC coil
MC62-K-00230	50kVar Capa. Sw. Contactor, 3P, 230VAC coil
MC62-K-00400	50kVar Capa. Sw. Contactor, 3P, 400VAC coil
MC74-K-00230	75kVar Capa. Sw. Contactor, 3P, 230VAC coil
MC74-K-00400	75kVar Capa. Sw. Contactor, 3P, 400VAC coil
MC115-K-00230	100kVar Capa. Sw. Contactor, 3P, 230VAC coil
MC115-K-00400	100kVar Capa. Sw. Contactor, 3P, 400VAC coil

DC Operated Contactor Low power consumption 3W inrush-sealed

Part Number	Description
MCD10-S-10=24	Contacto 4kW 10A 3P, 1 NO Aux. 24VDC coil
MCD14-S-10=24	Contacto 5.5kW 14A 3P, 1 NO Aux. 24VDC coil
MCD18-S-10=24	Contacto 7.5kW 18A 3P, 1 NO Aux. 24VDC coil
MCD22-S-10=24	Contacto 11kW 22A 3P, 1 NO Aux. 24VDC coil
MCD32-S-00=24	Contacto 15kW 32A 3P, 24VDC coil
MCD40-S-00=24	Contacto 15kW 32A 3P, 24VDC coil

Contact blocks and interlocks

Part Number	Description
MBA-11	1 Open + 1 Closed for MB09-MB12 contactors - top mount
MBA-22	2 Open + 2 Closed for MB09-MB12 contactors - top mount
MCA01	1 N/C Contact, For MC10 to MC115 Contactors, Top Mount
MCA10	1 N/O Contact, For MC10 to MC115 Contactors, Top Mount
MCAH01	High Switching Capacity 25A AC1, 1 N/C Contact, Top Mount
MCAH10	High Switching Capacity 25A AC1, 1 N/O Contact, Top Mount
MCAS-11	1 Open + 1 Closed, For MC24 to MC115 Contactors, Side Mount
MCAT11	1 Open + 1 Closed, For MC151 to MC316 Contactors, Top Mount
MCIW	Interlock for MC10 to MC40 Contactors
MCIX	Interlock for MC50 to MC74 Contactors

Thermal overload relays

Part Number	Description
U12/16E0.9-MC	Manual reset Overload 0.6-0.9A, MC10N-MC22N
U12/16E1.2-MC	Manual reset Overload 0.8-1.2A, MC10N-MC22N
U12/16E1.8-MC	Manual reset Overload 1.2-1.8A, MC10N-MC22N
U12/16E2.7-MC	Manual reset Overload 1.8-2.7A, MC10N-MC22N
U12/16E4-MC	Manual reset Overload 2.7-4A, MC10N-MC22N
U12/16E6-MC	Manual reset Overload 4-6A, MC10N-MC22N
U12/16E9-MC	Manual reset Overload 6-9A, MC10N-MC22N
U12/16E11-MC	Manual reset Overload 8-11A, MC10N-MC22N
U12/16E14-MC	Manual reset Overload 10-14A, MC10N-MC22N
U12/16E18-MC	Manual reset Overload 13-18A, MC10N-MC22N
U12/16E23-MC	Manual reset Overload 17-23A, MC10N-MC22N
U12/16E30-MC	Manual reset Overload 22-30A, MC10N-MC22N
MCOR-1-0.18	Manu/Auto reset Overload 0.12-0.18A, MC10N-MC40
MCOR-1-0.27	Manu/Auto reset Overload 0.18-0.27A, MC10N-MC40
MCOR-1-0.4	Manu/Auto reset Overload 0.27-0.4A, MC10N-MC40
MCOR-1-0.6	Manu/Auto reset Overload 0.4-0.6A, MC10N-MC40
MCOR-1-0.9	Manu/Auto reset Overload 0.6-0.9A, MC10N-MC40
MCOR-1-1.2	Manu/Auto reset Overload 0.8-1.2A, MC10N-MC40
MCOR-1-1.8	Manu/Auto reset Overload 1.2-1.8A, MC10N-MC40
MCOR-1-2.7	Manu/Auto reset Overload 1.8-2.7A, MC10N-MC40
MCOR-1-4	Manu/Auto reset Overload 2.7-4A, MC10N-MC40
MCOR-1-6	Manu/Auto reset Overload 4-6A, MC10N-MC40
MCOR-1-9	Manu/Auto reset Overload 6-9A, MC10N-MC40
MCOR-1-11	Manu/Auto reset Overload 8-11A, MC10N-MC40
MCOR-1-14	Manu/Auto reset Overload 10-14A, MC10N-MC40
MCOR-1-18	Manu/Auto reset Overload 13-18A, MC10N-MC40
MCOR-1-24	Manu/Auto reset Overload 17-24A, MC10N-MC40
MCOR-1-32	Manu/Auto reset Overload 23-32A, MC10N-MC40
MCOR-2-14	Manual reset Overload 10-14A, MC24-MC40
MCOR-2-20	Manual reset Overload 14-20A, MC24-MC40
MCOR-2-28	Manual reset Overload 20-28A, MC24-MC40
MCOR-2-42	Manual reset Overload 28-42A, MC24-MC40

More overloads also available, visit our website www.imopc.com



Visit our website
www.imopc.com

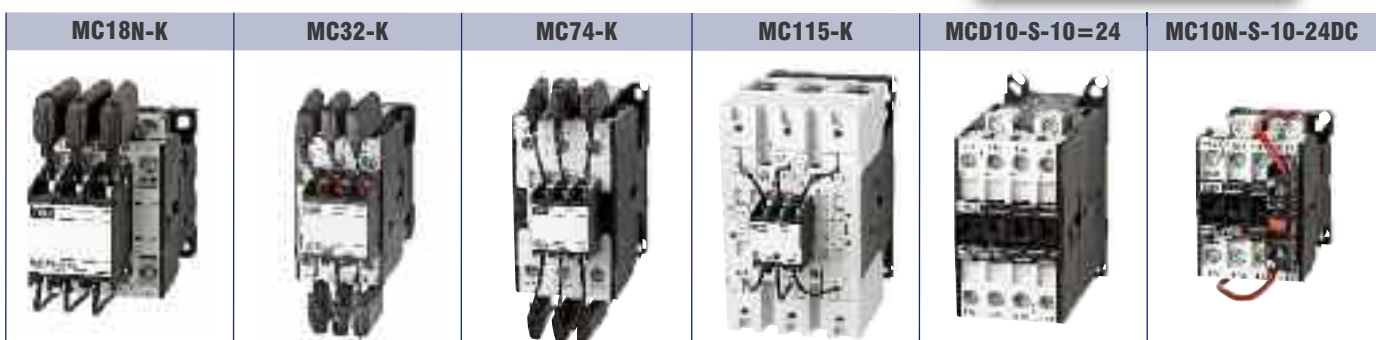

Modular Heating & Lighting Contactors



Go to www.imopc.com for full details

- Suitable for control of lamps, heating, air conditioning and motor control
- 2 or 4 pole version
- 20A up to 63A 400V AC1
- Multiple pole configuration available
- Space saving design
- Low switching noise
- Low power consumption
- Coil voltage 230VAC, 24VAC or 24VDC



Part Number	Description
HC20-20230	20A 2 Pole NO 230VAC coil
HC20-02230	20A 2 Pole NC 230VAC coil
HC20-2024	20A 2 Pole NO 24VAC coil
HC25-20230	25A 2 Pole NO 230VAC coil
HC25-40230	25A 4 Pole NO 230VAC coil
HC25-04230	25A 4 Pole NC 230VAC coil
HC40-40230	40A 4 Pole NO 230VAC coil
HC63-40230	63A 4 Pole NO 230VAC coil

iStart Enclosed Starters

Starters with metal enclosures



- Push button stop/start
- IP55 metal enclosure
- Prewired to accept overload
- Available with 3 phase and Neutral isolator

Part Number	Description
DOLI-7.5230	DOL & Isolator 7.5kW 230VAC SUPPLY (SR12)
DOLI-7.5400	DOL & Isolator 7.5kW 400VAC SUPPLY (SR13)
SDSI-7.5230	Star Delta Starter 7.5kW 16A + Isolator, 230VAC Control, IP55 (SD20)
SDSI-7.5400	Star Delta Starter 7.5kW 16A + Isolator, 400VAC Control, IP55 (SD21)
SDSI-15230	Star Delta Starter 15kW 30A + Isolator, 230VAC Control, IP55 (SD22)
SDSI-15400	Star Delta Starter 15kW 30A + Isolator, 400VAC Control, IP55 (SD23)

Starters with plastic enclosures



- Push button stop/start
- IP65 ABS enclosure
- Prewired to accept overload

Part Number	Description
DOL10230	DOL Starter 4kW 10A Start and Stop, 230VAC coil
DOL10400	DOL Starter 4kW 10A Start and Stop, 400VAC coil
DOL10110	DOL Starter 4kW 10A Start and Stop, 110VAC coil
DOL18230	DOL Starter 7.5kW 18A Start and Stop, 230VAC coil
DOL18400	DOL Starter 7.5kW 18A Start and Stop, 400VAC coil
DOL18110	DOL Starter 7.5kW 18A Start and Stop, 110VAC coil



Switch 79/89 Series

Isolators

- On load Isolators
- 3 and 4 pole as standard
- Up to 8 pole versions
- Wide ratings from 63A to 630A
- Rotary door interlocked handles
- Shaft extensions from 120mm to 500mm
- Full range of accessories
- Din rail and chassis mount versions

Base Mount Compact Isolator - CM Series

Part Number	Description
CM793063	3 Pole 63A
CM793100	3 Pole 100A
CM793125	3 Pole 125A
CM794100	4 Pole 100A
CM794125	4 Pole 125A
CM794160	4 Pole 160A
CM794200	4 Pole 200A

Accessories - CM Series

Part Number	Description
79E1005	200mm Extension Shaft For CM79 Series 63-200A Rotary Type
79E1008	400mm Extension Shaft For CM79 Series 63-200A Rotary Type
79H1005	Rotary Black Handle To Suit CM Series, 63-200 Amps
79H1006	Rotary Red/Yellow Handle To Suit CM Series, 63-200 Amps

Switch Fuses

- On load fuse switches and Isolators
- 3 and 4 pole versions to 800 Amps
- Door interlocked handles:
 - Rotary and pistol
 - 3 padlocking positions

Switch Fuses - CF Series

Part Number	Description
CF793020	Compact fuse switch 3 pole 20A
CF793N20	Compact fuse switch 3 P + Neutral 20A
CF793032	Compact fuse switch 3 pole 32A
CF793N32	Compact fuse switch 3 P + Neutral 32A
79H1006	Red/Yel Handle, Pistol type, IP65
79E1017	Shaft Extension 320mm

Base Mount Isolator - MS Series

Part Number	Description
MS793160	3 Pole 160 Amps
MS793200	3 Pole 200 Amps
MS793250	3 Pole 250 Amps
MS793400	3 Pole 400 Amps
MS793630	3 Pole 630 Amps
MS794200	4 Pole 200 Amps
MS794315	4 Pole 315 Amps
MS794630	4 Pole 630 Amps

Accessories - MS Series

Part Number	Description
79E1010	200mm Extension Shaft For MS & SF Series 32-630A Pistol Type
79E1011	250mm Extension Shaft For MS & SF Series 32-630A Pistol Type
79E1012	320mm Extension Shaft For MS79 Range & SF79 32-400 Amp Pistol Type
79E1013	500mm Extension Shaft For MS79 Range & SF79 32-400 Amp Pistol Type
79H1008	Pistol Black Handle To Suit MS Series and SF Series 100- 400 Amps
79H1009	Pistol Red/Yellow Handle To Suit MS Series and SF Series 100-400 Amps

- Shaft extensions from 120mm to 500mm
- Auxilliary contacts - various options
- Terminal shrouds - various options
- Full range of neutral terminals

Switch Fuses - SF Series

Part Number	Description
SF893032	Fuse switch 3 pole 32A, BS88 fuse size A1
SF893063	Fuse switch 3 pole 63A, BS88 fuse size A2
SF893100	Fuse switch 3 pole 100A, BS88 fuse size A4
SF893250	Fuse switch 3 pole 250A, BS88 fuse size B1-B3
SF893400	Fuse switch 3 pole 400A, BS88 fuse size B1-B4
SF894160	Fuse switch 4 pole 160A, BS88 fuse size A4
79H1006	Red/Yel Handle, Pistol type, IP65, 32-63A
79H1009	Red/Yel Handle, Pistol type, IP65, 100-400A
79E1012	Shaft Extension 320mm, 32-400A

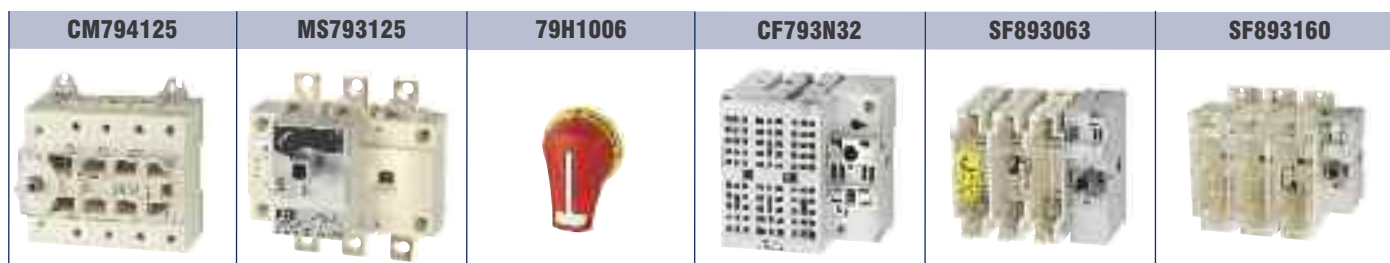

DC Isolators



Go to www.imopc.com for full details

Solar Isolators “SI..” are switch gears for interrupting the DC/AC-Inverter from the solar-panels. Photovoltaic installations have to be equipped with DC-isolators in accordance to IEC 60364-7-712.

- TRUE DC Isolator to UL508i
- Available in 2,4,6,8 pole versions
- Max. rated current of 58A @ 1000VDC (Acc. To DC21B for SI32)
- Max. rated current of 80A @ 600VDC (Acc. To DC21B for SI55)
- High reliability self-cleaning and vibration resistant knife contacts
- Arc suppression chamber
- Operator independent high speed switching (Max 5ms)
- Additional Security with patented “Safelock” function
- Compact and space saving design
- Maximum operator torque of 1Nm for easy operation (SI16-32)
- Poles can be wired in series to increase rating (DC21B and DC22B)
- Large box terminals with up to 25mm² cross sectional area for wiring
- Different mounting versions available (DIN / Base / Panel)
- Solar connectors are available (Female / Male / Branch)

Part Number	No. Of Poles	Description	Rating
SI16-PEL64R-2	2 Pole - 1 String	Enclosed IP66 2 pole	16A @ 800VDC
SI16-PEL64R-4	4 Pole - 2 Strings	Enclosed IP66 4 pole	16A @ 800VDC
SI16-PEL64R-4S	4 Pole - 1 String	Enclosed IP66 4 pole linked	16A @ 1500VDC
SI20-PEL64R-2	2 Pole - 1 Strings	Enclosed IP66 2 pole	20A @ 700VDC
SI20-PEL64R-4	4 Pole - 2 String	Enclosed IP66 4 pole	20A @ 700VDC
SI25-PEL64R-2	2 Pole - 1 String	Enclosed IP66 2 pole	25A @ 600VDC
SI25-PEL64R-4	4 Pole - 2 Strings	Enclosed IP66 4 pole	25A @ 600VDC
SI25-PEL64R-4S	4 Pole - 1 String	Enclosed IP66 4 pole linked	25A @ 1200VDC
SI32-PEL64R-2	2 Pole - 1 String	Enclosed IP66 2 pole	32A @ 600VDC
SI32-PEL64R-4	4 Pole - 2 Strings	Enclosed IP66 4 pole	32A @ 600VDC
SI32-PEL64R-4S	4 Pole - 1 String	Enclosed IP66 4 pole linked	32A @ 1200VDC
SI40-PEL64R-4	4 Pole - 2 Strings	Enclosed IP66 4 pole	40A @ 600VDC
SI55-PEL64R-4	4 Pole - 2 Strings	Enclosed IP66 4 pole	55A @ 600VDC
SI25-PM64-4	4 Pole - 2 Strings	Panel Mount Escutcheon Plate 64mm 4 pole	25A @ 600VDC
SI32-PM64-4	4 Pole - 2 Strings	Panel Mount Escutcheon Plate 64mm 4 pole	32A @ 600VDC
SI16-PM64R-2	2 Pole - 1 String	Panel Mount Rotary Handle 64mm 2 pole	16A @ 800VDC
SI25-PM64R-4	4 Pole - 2 Strings	Panel Mount Rotary Handle 64mm 4 pole	25A @ 600VDC
SI40-PM64R-4	4 Pole - 2 Strings	Panel Mount Rotary Handle 64mm 4 pole	40A @ 600VDC
SI55-PM64R-4	4 Pole - 2 Strings	Panel Mount Rotary Handle 64mm 4 pole	55A @ 600VDC
SI16-BMDC64-2	2 pole - 1 string	Base Mount Door Interlock Escutcheon Plate 64mm 2 pole	16A @ 800VDC
SI16-BMDC64R-2	2 pole - 1 string	Base Mount Door Interlock Rotary Handle 64mm 2 pole	16A @ 800VDC
SI25-BMDC64R-2	2 pole - 1 string	Base Mount Door Interlock Rotary Handle 64mm 2 pole	25A @ 600VDC
SI40-BMDC64R-4	4 Pole - 2 Strings	Base Mount Door Interlock Rotary Handle 64mm 4 pole	40A @ 600VDC
SI55-BMDC64R-4	4 Pole - 2 Strings	Base Mount Door Interlock Rotary Handle 64mm 4 pole	55A @ 600VDC
SI16-DB-4	4 Pole - 2 Strings	Modular 4 pole	16A @ 800VDC
SI25-DB-2	2 Pole - 1 String	Modular 2 pole	25A @ 600VDC
SI16-DBL-4	4 Pole - 2 Strings	Modular Lockable 4 pole	16A @ 800VDC
SI16-DBL-8	8 Pole - 4 Strings	Modular Lockable 8 pole	16A @ 800VDC
SI32-DBL-4	4 Pole - 2 Strings	Modular Lockable 4 pole	32A @ 600VDC
SI25-SHM-2	2 Pole - 1 String	Single Hole Mounting 2 pole	25A @ 600VDC
SI25-SHM-4	4 Pole - 2 Strings	Single Hole Mounting 4 pole	25A @ 600VDC



Listed are some of our most popular products. A dedicated catalogue is available from IMO which includes all options for DC Isolators.

SI16-DBL-4	SI16-PM64R-2	SI16-SHML-2	SI16-BMDC64R-4	SI55-DBL-4

AC Isolators

Enclosed Isolator - PE Series

- 3 to 8 pole
- On load 20Amps to 80Amps
- Interlocked enclosure lid
- Padlocking positions
- IP65 enclosure
- Side mounted auxilliary contacts 1N/O+1N/C

Part Number	Description
PE69-3020	3 Pole 20 Amps, IP65
PE69-3025	3 Pole 25 Amps, IP65
PE69-3032	3 Pole 32 Amps, IP65
PE69-3040	3 Pole 40 Amps, IP65
PE69-3063	3 Pole 63 Amps, IP65
PE69-3080	3 Pole 80 Amps, IP65
PE69-4020	4 Pole 20 Amps, IP65
PE69-4025	4 Pole 25 Amps, IP65
PE69-4032	4 Pole 32 Amps, IP65
PE69-4040	4 Pole 40 Amps, IP65
PE69-4063	4 Pole 63 Amps, IP65
PE69-4080	4 Pole 80 Amps, IP65
PE69-6020	6 Pole 20 Amps, IP65
PE69-6025	6 Pole 25 Amps, IP65
PE69-6032	6 Pole 32 Amps, IP65
PE69-6040	6 Pole 40 Amps, IP65
PE69-6063	6 Pole 63 Amps, IP65
PE69-8020	8 Pole 20 Amps, IP65
PE69-8025	8 Pole 25 Amps, IP65
PE69-8032	8 Pole 32 Amps, IP65
PE69-8040	8 Pole 40 Amps, IP65
PE69-8063	8 Pole 63 Amps, IP65
PE69-8080	8 Pole 80 Amps, IP65

Base Mount Isolator - LB Series

- 3 and 4 pole
- On load 20Amps to 80Amps
- Door interlocked handles:
 - Red/Yellow and Black, 64 x 64mm, 48 x 48mm
 - 1 Padlocking position on 48 x 48mm version
 - 3 Padlocking positions on 64 x 64mm version

Part Number	Description
LB69-3020	3 Pole 20 Amps
LB69-3025	3 Pole 25 Amps
LB69-3032	3 Pole 32 Amps
LB69-3040	3 Pole 40 Amps
LB69-3063	3 Pole 63 Amps
LB69-3080	3 Pole 80 Amps
LB69-4020	4 Pole 20 Amps
LB69-4025	4 Pole 25 Amps
LB69-4032	4 Pole 32 Amps
LB69-4040	4 Pole 40 Amps
LB69-4063	4 Pole 63 Amps
LB69-4080	4 Pole 80 Amps

PE & LB Accessories

Part Number	Description
H69-0001	Red/yellow handle 64 x 64mm
H69-0002	Black handle 64 x 64mm
H69-0003	Red/yellow handle 48 x 48mm
H69-0004	Black handle 48 x 48mm
J7049	Door handle mounting tool
E69-0001	Extension shaft – 100mm
E69-0002	Extension shaft – 200mm
E69-0003	Extension shaft – 300mm
E69-0004	Extension shaft – 400mm
A69-0001	Auxiliary contacts 1 n/o + 1 N/C
A69-0002	Auxiliary contacts 2 N/O
SN69-0001	Solid neutral block
SP69-0001	Add on neutral switching pole 20-40A

Front Panel Mount - PM Series

- 3 and 4 pole
- On load 20Amps to 80Amps
- Door handles:
 - Red/Yellow and Black, 64 x 64mm, 48 x 48mm
 - 1 Padlocking position on 48 x 48mm version
 - 3 Padlocking positions on 64 x 64mm version

Part Number	Description
PM69-3020-B64	3P 20A Black Handle 64x64mm
PM69-3020-RY48	3P 20A Red/Yellow Handle 48x48mm
PM69-3020-RY64	3P 20A Red/Yellow Handle 64x64mm
PM69-3025-RY64	3P 25A Red/Yellow Handle 64x64mm
PM69-3032-RY64	3P 32A Red/Yellow Handle 64x64mm
PM69-3040-RY64	3P 40A Red/Yellow Handle 64x64mm
PM69-3063-RY64	3P 63A Red/Yellow Handle 64x64mm
PM69-3080-RY64	3P 80A Red/Yellow Handle 64x64mm
PM69-4020-RY64	4P 20A Red/Yellow Handle 64x64mm
PM69-4032-RY48	4P 32A Red/Yellow Handle 48x48mm
PM69-4040-RY64	4P 40A Red/Yellow Handle 64x64mm
PM69-4063-RY64	4P 63A Red/Yellow Handle 64x64mm

Direct Handle Base Mounted - DM Series

- 3 to 8 pole
- On load 20Amps to 80Amps
- 1 padlocking position
- 48x48 handle black or Red/Yellow
- To suit in distribution boxes

Part Number	Description
DM69-3020-RY48	3 Pole 20 Amps Red/Yellow Handle
DM69-3032-RY48	3 Pole 32 Amps Red/Yellow Handle
DM69-3063-RY48	3 Pole 63 Amps Red/Yellow Handle
DM69-4032-RY48	4 Pole 32 Amps Red/Yellow Handle
DM69-4063-RY48	4 Pole 63 Amps Red/Yellow Handle
DM69-8032-RY48	8 Pole 32 Amps Red/Yellow Handle



Motor Circuit Breakers C4



Go to www.imopc.com for full details

- Motor protection rating up to 100 Amps
- Short circuit breaking capacity up to 100kA
- Phase failure protection
- DIN rail mounting
- Wide range of accessories

IMO C4 circuit breakers are designed to be a compact reliable unit that offers high protection for 3 phase induction motors but can also be used as a motor starter, and for line protection. Integrating the functions of a circuit breaker and thermal overload relay in single unit it significantly reduces the space requirements and wiring necessary for an installation that would have traditionally used a three component starter assembly.





With ratings from 0.16A to 100A in 3 frame sizes the IMO C4 has a short circuit breaking capacity of 100kA (Icu) and incorporates both thermal overload functionality and phase failure protection for phase-to-phase faults thereby offering comprehensive protection of the motor and controlling electrical circuitry.

The C4 is available with either rocker or rotary control and is complemented with a wide range of accessories that enable it to be connected to supplementary products, such as an IMO contactor, to give greater versatility. The design flexibility of the C4 ensures its convenience for installers, with the availability of auxiliary contacts that can be front or side mounted, to busbar systems available for the interconnection of up to 5 units; the C4 can be wired from either the top or bottom supply terminals without any reduction in ratings.

DIN rail and panel mount models designed in accordance with IEC 60947-1, IEC 60947-2, IEC 60947-4-1, VDE 660 and UL approved (E223201) ensure that the IMO C4 circuit breakers are ideal for installation and OEM applications.

Part Number	Description
C4/32R-0,63	0,4-0,63A Instantaneous Release 8,2A
C4/32R-1	0,63-1A Instantaneous Release 13A
C4/32R-1,6	1,0-1,6A Instantaneous Release 20,8A
C4/32R-2,5	1,6-2,5A Instantaneous Release 32,5A
C4/32R-4	2,5-4A Instantaneous Release 52A
C4/32R-6	4-6A Instantaneous Release 78A
C4/32R-8	5-8A Instantaneous Release 104A
C4/32R-10	6-10A Instantaneous Release 130A
C4/32R-13	9-13A Instantaneous Release 169A
C4/32R-17	11-17A Instantaneous Release 221A
C4/32R-22	14-22A Instantaneous Release 286A
C4/32T-1,6	1,0-1,6A Instantaneous Release 20,8A
C4/32T-4	2,5-4A Instantaneous Release 52A
C4/32T-6	4-6A Instantaneous Release 78A
C4/32T-8	5-8A Instantaneous Release 104A
C4/32T-13	9-13A Instantaneous Release 169A
C432VK1	Link Module For The C4/32... MCB's To MB Contactors
C432VK3	Link Module For The C4/32... MCB's To MC10 & MC22 Contactors
C4HQ11	Auxiliary Contact Block Top Mount, 1N/O + 1N/C
C4HS11	Auxiliary Contact Block Side Mount, 1N/O + 1N/C



C4/32T	C4/32R	C4/63R	C4/100R
			

Miniature Circuit Breakers B10



Go to www.imopc.com for full details

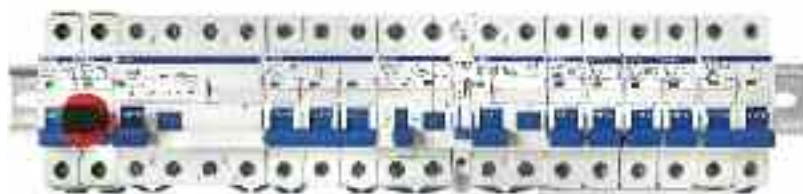

The IMO range of miniature circuit breakers has been designed for protection of electrical installations against overload and short circuits and is manufactured in accordance with EN60898.

Ordering codes and examples

B10	C	10	04A Rated current Amps
MCB 4.5kA B4			
MCB 6kA B6			
MCB 10kA B10			
Operating characteristic B			
Operating characteristic C			
Operating characteristic D			
		10 Single Pole	
		1N Single Pole + Neutral	
		20 Two Pole	
		30 Three Pole	
		3N Three Pole + Neutral	

Current ratings (A): 2/4/6/10/16/20/25/32/40/50/63

B6 range standard supply in B curve

B4 range only available in 1P+N

Part Number	Description
B4C1N10A	MCB 4.5kA C Curve 1P+N 10A
B6B1010A	MCB 6kA B Curve 1P 10A
B10C1002A	MCB 10kA C Curve 1P 2A
B10C1006A	MCB 10kA C Curve 1P 6A
B10C2010A	MCB 10kA C Curve 2P 10A
B10D1002A	MCB 10kA D Curve 1P 2A
B10D3010A	MCB 10kA D Curve 3P 10A

Isolating Switch

Part Number	Description
BIS1063A	1 pole 63A 230/400VAC
BIS2063A	2 pole 63A 230/400VAC
BIS2100C	2 pole 100A 230/400VAC
BIS2125A	2 pole 125A 230/400VAC
BIS3063A	3 pole 63A 230/400VAC
BIS4063A	4 pole 63A 230/400VAC
BIS4125A	4 pole 125A 230/400VAC



Residual Current Circuit Breaker (RCCB AC type)

Part Number	Description
B10R2025-30	RCCB 10kA 30mA 1P+N 25A
B10R2032-30	RCCB 10kA 30mA 1P+N 32A
B10R2040-30	RCCB 10kA 30mA 1P+N 40A
B10R2063-30	RCCB 10kA 30mA 1P+N 63A
B10R4025-30	RCCB 10kA 30mA 3P+N 25A
B10R4032-30	RCCB 10kA 30mA 3P+N 32A
B10R4040-30	RCCB 10kA 30mA 3P+N 40A
B10R4063-30	RCCB 10kA 30mA 3P+N 63A

Residual Current Breaker with Overload (RCBO A type)

Part Number	Description
B6CR1N06-30-A	RCBO 6kA 30mA 1P+N 6A
B6CR1N10-30-A	RCBO 6kA 30mA 1P+N 10A
B6CR1N16-30-A	RCBO 6kA 30mA 1P+N 16A
B6CR1N20-30-A	RCBO 6kA 30mA 1P+N 20A
B6CR1N25-30-A	RCBO 6kA 30mA 1P+N 25A
B6CR1N32-30-A	RCBO 6kA 30mA 1P+N 32A

Accessories

Part Number	Description
B10-F3	Auxiliary contact side mounting 1PCO 6A
B10-S3	Shunt trip side mounting 230VAC
B10-LOCK	Lever locking device (padlock not inc)
B10BB1P100-1M	Busbar Pin type 1P 1m
B10BB1F100-1M	Busbar Fork type 1P 1m
B10BB3P100-1M	Busbar Pin type 3P 1m
B10BB3F100-1M	Busbar Fork type 3P 1m
B10BBCAP1	End cap for 1P busbar
B10BBCAP3	End cap for 3P busbar

Listed are some of our most popular products. A dedicated catalogue is available from IMO which includes all options for MCBs.



DIN Rail Terminals



Go to www.imopc.com for full details

IMO's range of DIN Rail Terminals offers the customer a host of features at unbeatable prices. With high quality throughout the IMO range includes standard modular feed-through terminals, double and triple level terminals, fused terminals, disconnects and three-level sensor terminals just to highlight a few.

IMO products can be offered with screw or spring clamp terminals and although offered in beige as standard, the range is available in multiple colours throughout, allowing OEMs and installers to use colour code systems within their panels.

In line with the constant drive towards greater packing density of all components within the control panel, IMO has made its DIN Rail Terminals both lighter and more compact whilst their strength is ensured by using self-extinguishing unbreakable polyamide 6.6. IMO DIN Rail Terminals are offered in sizes from 2.5mm² through to 240mm² and have angled cable entry to simplify the introduction of the conductors.

Our Din Terminals are designed to meet both national and international standards, and have gained approvals from organisations such as UL, CSA, DNV, VDE, GOST; and a number of products are also certified ATEX and IECEx.







Below is a list of some of the most popular products from within the IMO range, a full catalogue is available from IMO detailing all DIN Rail Terminals and accessories.

Part Number	Description
ER2.5BEIGE	2.5mm Beige Terminal
ER2.5PBEIGE	2.5mm Beige Terminal (Push-in Cross Connector)
ER4BEIGE	4mm Beige Terminal
ER4PBEIGE	4mm Beige Terminal (Push-in Cross Connector)
ER6BEIGE	6mm Beige Terminal
ER10BEIGE	10mm Beige Terminal
ER16BEIGE	16mm Beige Terminal
ER35PBEIGE	35mm Beige Terminal
ER70BEIGE	70mm High Current Terminal
ER95BEIGE	95mm High Current Terminal
ERPE2.5/4	2.5 to 4mm Earth Terminal
ERPE2.5P	2.5mm Earth Terminal (Push-in Cross Connector)
ERPE6/10	6 to 10mm Earth Terminal
ERPE16P	16mm Earth Terminal
ERPE35P	35mm Earth Terminal
ERB95	95mm Bolt Connection High Current Terminal
ERB150	150mm Bolt Connection High Current Terminal
ERD2.5BEIGE	2.5mm Double Deck Terminal
ERD4BEIGE	4mm Double Deck Terminal
ERT3BEIGE	2.5mm mm Triple Deck Terminal
ERTD4	4mm Disconnect Terminal

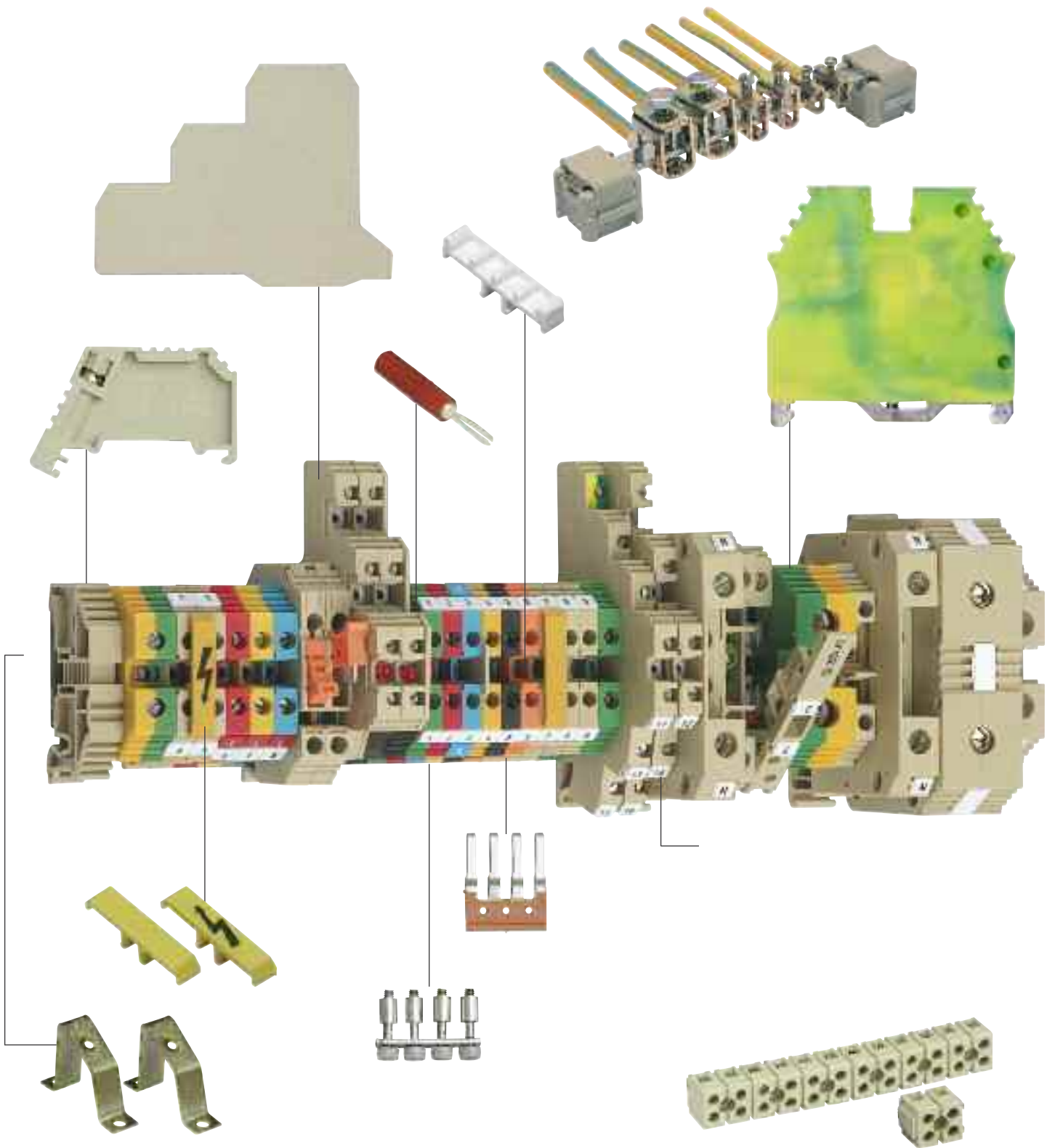
Part Number	Description
ERF2BEIGE	6mm Fuse Terminal
ERF3BEIGE	4mm Fuse Terminal
ERWT2NBEIGE	10mm Test/Disconnect Terminal
ERDT10/16	10/16mm Distribution Terminal
SC2.5	2.5mm Beige Spring Clamp Terminal
SC4	4mm Beige Spring Clamp Terminal
SC6	6mm Beige Spring Clamp Terminal
SC10	10mm Beige Spring Clamp Terminal
SCPE2.5	2.5mm Spring Clamp Earth Terminal
SCPE4	4mm Spring Clamp Earth Terminal
SCPE6	6mm Spring Clamp Earth Terminal
SCPE10	10mm Spring Clamp Earth Terminal
SCD2.5BEIGE	2.5mm Beige Double Deck Spring Clamp Terminal
SCD4BEIGE	4mm Beige Double Deck Spring Clamp Terminal
SCT3BEIGE	2.5mm Beige Triple Deck Spring Clamp Terminal
SCTD4	2.5mm Beige Spring Clamp Disconnect Terminal
SCF3BEIGE	4mm Beige Spring Clamp Fuse Terminal
SCS2.5BEIGE	2.5mm Beige Spring Clamp Terminal for PCB Connections
SCD2.5EBEIGE	2.5mm Beige Spring Clamp Terminal 2 In 1 Out
SCD2.5CBEIGE	2.5mm Beige Spring Clamp Terminal 2 In 2 Out

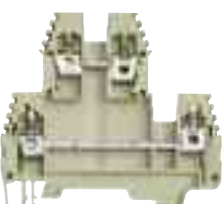
Feed-through - ER	Earth - ERPE	Spring Clamp - SC	Spring Clamp Earth - SCPE	PCB Connection - SCS2.5	Bolt Connection - ERB

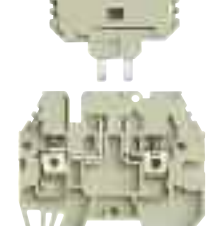

Double Level - ERD	Spring Clamp - SCD	Sensor Terminal - ERT3	Distribution - ERDT	Disconnect - ERTD	Fuse - ERF3
					

Industrial Power Relays



Go to www.imopc.com for full details

Slimmer Of The Year... ... The IMO ETS Relay and SRSI Socket

IMO's range of Slimline Din Rail mount Relays at just 6mm wide provide substantial space saving in a panel when compared to traditional Plug-In style relays. The new range with Plug-In Relays rated at 6 Amps allows easy maintenance without the need for complete rewiring of the socket. The SRSI sockets come with LED indicators providing true circuit protection (48V and above) showing the coil energising state. The sockets are available in wide operating voltages for both AC and DC circuits within the same unit, providing greater flexibility for the user and reducing the number of stock items required.



High Capacity Relays

Part Number	Description
HY1A112AC	1PNO, 30A, 12VAC Coil, Solder Lug Or Push On, Coil Resistance 75 Ohm
HY1A112DC	1PNO, 30A, 12VDC Coil, Solder Lug Or Push On, Coil Resistance 75 Ohm
HY1A124AC	1PNO, 30A, 24VAC Coil, Solder Lug Or Push On, Coil Resistance 300 Ohm
HY1A124DC	1PNO, 30A, 24VDC Coil, Solder Lug Or Push On, Coil Resistance 300 Ohm
HY1A148DC	1PNO, 30A, 48VDC Coil, Solder Lug Or Push On, Coil Resistance 1200 Ohm
HY1A1110AC	1PNO, 30A, 110VAC Coil, Solder Lug Or Push On, Coil Resistance 5200 Ohm
HY1A1110DC	1PNO, 30A, 110VDC Coil, Solder Lug Or Push On, Coil Resistance 6300 Ohm
HY1A1230AC	1PNO, 30A, 230VAC Coil, Solder Lug Or Push On, Coil Resistance 20800 Ohm
HY2A112AC	2PNO, 25A, 12VAC Coil, Solder Lug Or Push On, Coil Resistance 75 Ohm
HY2A112DC	2PNO, 25A, 12VDC Coil, Solder Lug Or Push On, Coil Resistance 75 Ohm
HY2A124AC	2PNO, 25A, 24VAC Coil, Solder Lug Or Push On, Coil Resistance 300 Ohm
HY2A124DC	2PNO, 25A, 24VDC Coil, Solder Lug Or Push On, Coil Resistance 300 Ohm
HY1A1110AC	2PNO, 25A, 110VAC Coil, Solder Lug Or Push On, Coil Resistance 5200 Ohm
HY2A1230AC	2PNO, 25A, 230VAC Coil, Solder Lug Or Push On, Coil Resistance 20800 Ohm
HY2A212DC	2PNO, 25A, 12VDC Coil, PCB Mount, Coil Resistance 75 Ohm
HY2A312DC	2PNO, 25A, 12VDC Coil, PCB Mount Alternative Layout, Coil Resistance 75 Ohm
HY2A224DC	2PNO, 25A, 24VDC Coil, PCB Mount, Coil Resistance 300 Ohm

QY Relays

Part Number	Description
QY21XN12AC	2PCO, 10A, 12VAC Coil, LED, Plug-in
QY21XN12DC	2PCO, 10A, 12VDC Coil, LED, Plug-in
QY21XN24AC	2PCO, 10A, 24VAC Coil, LED, Plug-in
QY21XN24DC	2PCO, 10A, 24VDC Coil, LED, Plug-in
QY21XN120AC	2PCO, 10A, 120VAC Coil, LED, Plug-in
QY21XN230AC	2PCO, 10A, 230VAC Coil, LED, Plug-in
QY21XX12DC	2PCO, 10A, 12VDC Coil, Plug-in
QY21XX24AC	2PCO, 10A, 24VAC Coil, Plug-in
QY21XX24DC	2PCO, 10A, 24VDC Coil, Plug-in
QY21XX120AC	2PCO, 10A, 120VAC Coil, Plug-in
QY21XX240AC	2PCO, 10A, 240VAC Coil, Plug-in
QY21XXF12DC	2PCO, 10A, 12VDC Coil, Plug-in, Flanged
QY21XXF240AC	2PCO, 10A, 240VAC Coil, Plug-in, Flanged
QY22XX12DC	2PCO, 10A, 12VDC Coil, PCB Mount
QY22XX24DC	2PCO, 10A, 24VDC Coil, PCB Mount
QY22XX240AC	2PCO, 10A, 240VAC Coil, PCB Mount

ETS	SRRHN/SRP	HY1/2	HY	EPR

RS Relays

Part Number	Description
RS2PN12AC	8 pins, 2PCO, 10A, 12VAC Coil, Plug-in, LED & Manual Test/Latch
RS2PN12DC	8 pins, 2PCO, 10A, 12VDC Coil, Plug-in, LED & Manual Test/Latch
RS2PN24AC	8 pins, 2PCO, 10A, 24VAC Coil, Plug-in, LED & Manual Test/Latch
RS2PN24DC	8 pins, 2PCO, 10A, 24VDC Coil, Plug-in, LED & Manual Test/Latch
RS2PN48DC	8 pins, 2PCO, 10A, 48VDC Coil, Plug-in, LED & Manual Test/Latch
RS2PN110AC	8 pins, 2PCO, 10A, 110VAC Coil, Plug-in, LED & Manual Test/Latch
RS2PN110DC	8 pins, 2PCO, 10A, 110VDC Coil, Plug-in, LED & Manual Test/Latch
RS2PN230AC	8 pins, 2PCO, 10A, 230VAC Coil, Plug-in, LED & Manual Test/Latch
RS3PN12AC	11 pins, 3PCO, 10A, 12VAC Coil, Plug-in, LED & Manual Test/Latch
RS3PN12DC	11 pins, 3PCO, 10A, 12VDC Coil, Plug-in, LED & Manual Test/Latch
RS3PN24AC	11 pins, 3PCO, 10A, 24VAC Coil, Plug-in, LED & Manual Test/Latch
RS3PN24DC	11 pins, 3PCO, 10A, 24VDC Coil, Plug-in, LED & Manual Test/Latch
RS3PN48DC	11 pins, 3PCO, 10A, 48VDC Coil, Plug-in, LED & Manual Test/Latch
RS3PN110AC	11 pins, 3PCO, 10A, 110VAC Coil, Plug-in, LED & Manual Test/Latch
RS3PN110DC	11 pins, 3PCO, 10A, 110VDC Coil, Plug-in, LED & Manual Test/Latch
RS3PN230AC	11 pins, 3PCO, 10A, 230VAC Coil, Plug-in, LED & Manual Test/Latch

HY Relays

Part Number	Description
2 Pole	
HY21PN12DC	2PCO, 7A, 12VDC Coil, Plug-in, LED & Manual Test/Latch
HY21PN24AC	2PCO, 7A, 24VAC Coil, Plug-in, LED & Manual Test/Latch
HY21PN24DC	2PCO, 7A, 24VDC Coil, Plug-in, LED & Manual Test/Latch
HY21PN120AC	2PCO, 7A, 120VAC Coil, Plug-in, LED & Manual Test/Latch
HY21PN240AC	2PCO, 7A, 240VAC Coil, Plug-in, LED & Manual Test/Latch
HY21XX12DC	2PCO, 7A, 12VDC Coil, Plug-in
HY21XX24AC	2PCO, 7A, 24VAC Coil, Plug-in
HY21XX24DC	2PCO, 7A, 24VDC Coil, Plug-in
HY21XX120AC	2PCO, 7A, 120VAC Coil, Plug-in
HY21XX240AC	2PCO, 7A, 240VAC Coil, Plug-in
3 Pole	
HY31PN24AC	3PCO, 7A, 24VAC Coil, Plug-in, LED & Manual Test/Latch
HY31PN24DC	3PCO, 7A, 24VDC Coil, Plug-in, LED & Manual Test/Latch
HY31PN230AC	3PCO, 7A, 230VAC Coil, Plug-in, LED & Manual Test/Latch
4 Pole	
HY41PN12AC	4PCO, 5A, 12VAC Coil, Plug-in, LED & Manual Test/Latch
HY41PN12DC	4PCO, 5A, 12VDC Coil, Plug-in, LED & Manual Test/Latch
HY41PN24AC	4PCO, 5A, 24VAC Coil, Plug-in, LED & Manual Test/Latch
HY41PN24DC	4PCO, 5A, 24VDC Coil, Plug-in, LED & Manual Test/Latch
HY41PN48AC	4PCO, 5A, 48VAC Coil, Plug-in, LED & Manual Test/Latch
HY41PN48DC	4PCO, 5A, 48VDC Coil, Plug-in, LED & Manual Test/Latch
HY41PN120AC	4PCO, 5A, 120VAC Coil, Plug-in, LED & Manual Test/Latch
HY41PN110DC	4PCO, 5A, 110VDC Coil, Plug-in, LED & Manual Test/Latch
HY41PN240AC	4PCO, 5A, 240VAC Coil, Plug-in, LED & Manual Test/Latch
HY41PX12DC	4PCO, 5A, 12VDC Coil, Plug-in, Manual Test/Latch
HY41PX24DC	4PCO, 5A, 24VDC Coil, Plug-in, Manual Test/Latch
HY41PX48DC	4PCO, 5A, 48VDC Coil, Plug-in, Manual Test/Latch

QY	RS

HY Relays Cont.

Part Number	Description
HY41PX120AC	4PCO, 5A, 120VAC Coil, Plug-in, Manual Test/Latch
HY41PX240AC	4PCO, 5A, 240VAC Coil, Plug-in, Manual Test/Latch
HY41XX12AC	4PCO, 5A, 12VAC Coil, Plug-in
HY41XX12DC	4PCO, 5A, 12VDC Coil, Plug-in
HY41XX24AC	4PCO, 5A, 24VAC Coil, Plug-in
HY41XX24DC	4PCO, 5A, 24VDC Coil, Plug-in
HY41XX48AC	4PCO, 5A, 48VAC Coil, Plug-in
HY41XX120AC	4PCO, 5A, 120VAC Coil, Plug-in
HY41XX240AC	4PCO, 5A, 240VAC Coil, Plug-in
HY42XX12DC	4PCO, 5A, 12VDC Coil, PCB Mount
HY42XX24AC	4PCO, 5A, 24VAC Coil, PCB Mount
HY42XX24DC	4PCO, 5A, 24VDC Coil, PCB Mount
HY42XX120AC	4PCO, 5A, 120VAC Coil, PCB Mount
HY42XX240AC	4PCO, 5A, 240VAC Coil, PCB Mount

Slimline Plug-In Power Relays

Part Number	Description
ETS-1AN-SL-5VDC	Power Relay, 6A, SPNO, 5VDC, AgNi, Sealed
ETS-1AN-SL-6VDC	Power Relay, 6A, SPNO, 6VDC, AgNi, Sealed
ETS-1AN-SL-9VDC	Power Relay, 6A, SPNO, 9VDC, AgNi, Sealed
ETS-1AN-SL-12VDC	Power Relay, 6A, SPNO, 12VDC, AgNi, Sealed
ETS-1AN-SL-24VDC	Power Relay, 6A, SPNO, 24VDC, AgNi, Sealed
ETS-1AN-SL-60VDC	Power Relay, 6A, SPNO, 60VDC, AgNi, Sealed
ETS-1CN-SL-5VDC	Power Relay, 6A, SPCO, 5VDC, AgNi, Sealed
ETS-1CN-SL-6VDC	Power Relay, 6A, SPCO, 6VDC, AgNi, Sealed
ETS-1CN-SL-9VDC	Power Relay, 6A, SPCO, 9VDC, AgNi, Sealed
ETS-1CN-SL-12VDC	Power Relay, 6A, SPCO, 12VDC, AgNi, Sealed
ETS-1CN-SL-24VDC	Power Relay, 6A, SPCO, 24VDC, AgNi, Sealed
ETS-1CN-SL-48VDC	Power Relay, 6A, SPCO, 48VDC, AgNi, Sealed
ETS-1CN-SL-60VDC	Power Relay, 6A, SPCO, 60VDC, AgNi, Sealed

This is a list of some of the most popular products from within the IMO range, a full catalogue is available detailing all Industrial Relays and Sockets.

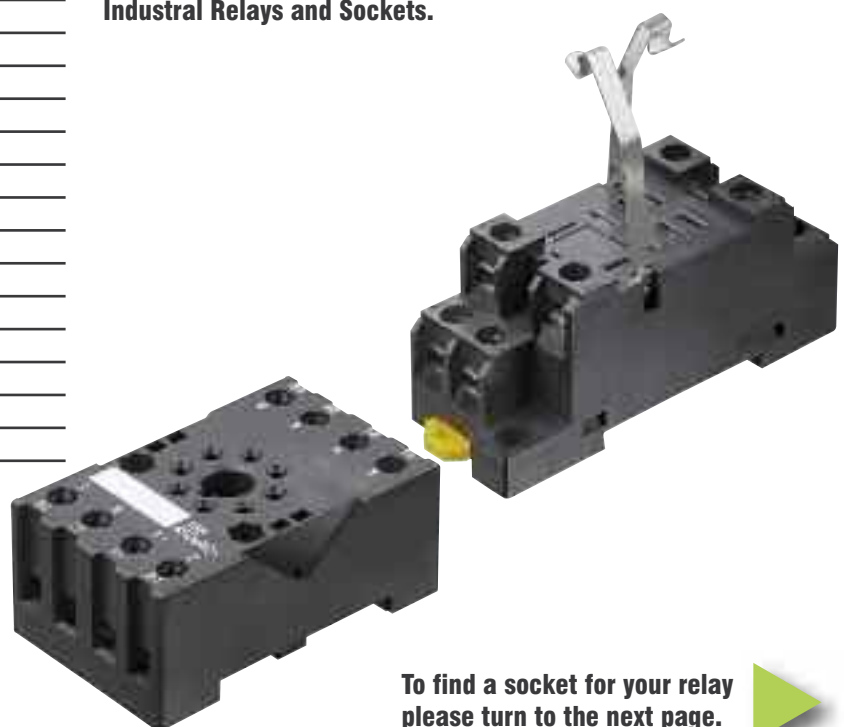

To find a socket for your relay please turn to the next page.

Relay Sockets



Go to www.imopc.com for full details

Sockets For Standard Plug-In Power Relays

Part Number	Socket For Relay:
SRN2-D, SRN2-S	HY21PN110AC
SRN2-D, SRN2-S	HY21PN230AC
SRN2-D, SRN2-S	HY21PN24AC
SRN2-D, SRN2-S	HY21PN24DC
SRN2-D, SRN2-S	HY21XX12DC
SRN2-D, SRN2-S	HY21XX230AC
SRN2-D, SRN2-S	HY21XX24AC
SRN2-D, SRN2-S	HY21XX24DC
SRN3-D, SRN3-S, SRN3-C	HY31PN230AC
SRN3-D, SRN3-S, SRN3-C	HY31PN24DC
SRN4-D, SRN4-S, SRN4-C	HY41PN110AC
SRN4-D, SRN4-S, SRN4-C	HY41PN110DC
SRN4-D, SRN4-S, SRN4-C	HY41PN12AC
SRN4-D, SRN4-S, SRN4-C	HY41PN12DC
SRN4-D, SRN4-S, SRN4-C	HY41PN230AC
SRN4-D, SRN4-S, SRN4-C	HY41PN24AC
SRN4-D, SRN4-S, SRN4-C	HY41PN24DC
SRN4-D, SRN4-S, SRN4-C	HY41PN48AC
SRN4-D, SRN4-S, SRN4-C	HY41PN48DC
SRN4-D, SRN4-S, SRN4-C	HY41PX12DC
SRN4-D, SRN4-S, SRN4-C	HY41PX24DC
SRN4-D, SRN4-S, SRN4-C	HY41XX110AC
SRN4-D, SRN4-S, SRN4-C	HY41XX12AC
SRN4-D, SRN4-S, SRN4-C	HY41XX12DC
SRN4-D, SRN4-S, SRN4-C	HY41XX230AC
SRN4-D, SRN4-S, SRN4-C	HY41XX24AC
SRN4-D, SRN4-S, SRN4-C	HY41XX24DC
SRN4-D, SRN4-S, SRN4-C	HY41XX48AC

Sockets For Standard Plug-In Power Relays

Part Number	Socket For Relay:
SRH2-C, SRP2-0	QY21PR24AC
SRH2-C, SRP2-0	QY21XN110AC
SRH2-C, SRP2-0	QY21XN12DC
SRH2-C, SRP2-0	QY21XN230AC
SRH2-C, SRP2-0	QY21XN24DC
SRH2-C, SRP2-0	QY21XX110AC
SRH2-C, SRP2-0	QY21XX12DC
SRH2-C, SRP2-0	QY21XX230AC
SRH2-C, SRP2-0	QY21XX24AC
SRH2-C, SRP2-0	QY21XX24DC
SRH2-C, SRP2-0	QY22XX12DC
SRH2-C, SRP2-0	QY22XX24DC



Sockets For Slimline Plug-In Power Relay

Part Number	Socket For Relay:
SRSI-24AC/DC	ETS-1AN-SL-24VDC
SRSI-24DC	ETS-1AN-SL-5VDC
SRSI-60AC/DC	ETS-1AN-SL-60VDC
SRSI-24AC/DC	ETS-1AN-SL-6VDC
SRSI-24AC/DC	ETS-1AN-SL-9VDC
SRSI-24AC/DC	ETS-1CN-SL-12VDC
SRSI-24AC/DC	ETS-1CN-SL-24VDC
SRSI-60AC/DC	ETS-1CN-SL-48VDC
SRSI-24DC	ETS-1CN-SL-5VDC
SRSI-60AC/DC	ETS-1CN-SL-60VDC
SRSI-24AC/DC	ETS-1CN-SL-6VDC
SRSI-24AC/DC	ETS-1CN-SL-9VDC
SRSI-24AC/DC	ETS-1CN1-SL-12VDC
SRSI-60AC/DC	ETS-1CN1-SL-48VDC
SRSI-24DC	ETS-1CN1-SL-5VDC
SRSI-60AC/DC	ETS-1CN1-SL-60VDC
SRSI-24AC/DC	ETS-1CN1-SL-6VDC
SRSI-24AC/DC	ETS-1CN1-SL-9VDC

Sockets For 8 Pin Plug-In Power Relays

Part Number	Socket For Relay:
SRR8, SRR8-M	RS2PN110AC
SRR8, SRR8-M	RS2PN110DC
SRR8, SRR8-M	RS2PN12AC
SRR8, SRR8-M	RS2PN12DC
SRR8, SRR8-M	RS2PN230AC
SRR8, SRR8-M	RS2PN24AC
SRR8, SRR8-M	RS2PN24DC
SRR8, SRR8-M	RS2PN48DC

Sockets For 11 Pin Plug-In Power Relays

Part Number	Socket For Relay:
SRR11, SRR11-M	RS3PN110AC
SRR11, SRR11-M	RS3PN110DC
SRR11, SRR11-M	RS3PN12AC
SRR11, SRR11-M	RS3PN12DC
SRR11, SRR11-M	RS3PN230AC
SRR11, SRR11-M	RS3PN24AC
SRR11, SRR11-M	RS3PN24DC

Sockets For Miniature Plug-In Power Relays

Part Number	Socket For Relay:
SRN3-T, SRN3-S, SRS1-0	SRRHN-1CN-SL-115VAC
SRN3-T, SRN3-S, SRS1-0	SRRHN-1CN-SL-230VAC
SRN3-T, SRN3-S, SRS1-0	SRRHN-1CN-SL-24VAC
SRN3-T, SRN3-S, SRS1-0	SRRHN-1CN-SL-24VDC
SRN3-T, SRN3-S, SRS1-0	SRRHN-1CT-SL-110VDC
SRN3-T, SRN3-S, SRS1-0	SRRHN-1CT-SL-24VAC
SRN3-T, SRN3-S, SRS1-0	SRRHN-1CT-SL-24VDC
SRN3-T, SRN3-S, SRS1-0	SRRHN-1CT-SL-48VDC
SRN5-T, SRN5-S, SRS1-1	SRRHN-2CN-SL-115VAC
SRN5-T, SRN5-S, SRS1-1	SRRHN-2CN-SL-230VAC
SRN5-T, SRN5-S, SRS1-1	SRRHN-2CN-SL-24VAC
SRN5-T, SRN5-S, SRS1-1	SRRHN-2CN-SL-24VDC
SRN5-T, SRN5-S, SRS1-1	SRRHN-2CT-SL-115VAC
SRN5-T, SRN5-S, SRS1-1	SRRHN-2CT-SL-110VDC
SRN5-T, SRN5-S, SRS1-1	SRRHN-2CT-SL-230VAC
SRN5-T, SRN5-S, SRS1-1	SRRHN-2CT-SL-24VAC
SRN5-T, SRN5-S, SRS1-1	SRRHN-2CT-SL-24VDC
SRN5-T, SRN5-S, SRS1-1	SRRHN-2CT-SL-48VDC
SRN5-T, SRN5-S, SRS1-1	SRP-1CN-SL-230VAC



Unrivalled Choice From the World's Finest

From a single product to a complete application solution, IMO has the product range and knowledge to meet today's most demanding application requirements.

The IMO Automation and Controls range fully addresses the sense, control and switch demands of today's factory automation and control environment. In terms of choice, the IMO line-up is peerless, offering everything today's engineer needs. From circuit protection and panelware to PLCs and AC drives. The first company in Europe to do so, IMO gives a no-quibble three year warranty on the majority of its electronics based control components and a five year warranty on its successful range of IMO Jaguar Drives.

IMO Electronics is at the leading edge of electro-mechanical PCB component technology, with a range of highly specified products designed to meet the most demanding applications. The company offers one of the most competitive, high quality and comprehensive PCB relay and Terminal Block connector ranges available, supported by sophisticated IT systems and infrastructure. The Electronics Division at IMO is perfectly positioned to meet all vendor and administration reduction requirements.

All products are manufactured to IMO's defined specification applying rigorous quality assurance and reliability standards. IMO products are built to comply with all relevant international approvals.

Cam Switches	Jaguar VXG 0.37-710kW
Din Rail Terminals	Jaguar VXR 0.4-15kW
Enclosures	Jaguar CUB 0.4-4kW
Isolators & Switch Fuses	Jaguar VXH 0.75-710kW
MCB, RCCD & RCBO	Jaguar AQUA 0.75-710kW
Motor Circuit Breakers	
Motor Control Gear	Audible devices
Power Supplies	PCB Terminal blocks
Signal Conditioning	Relays - automotive
Sockets	Relays - power
Timers	Relays - signal
Fieldbus remote I/O	DC Isolators
HMI	High Isolation Relays
Intelligent Relays	Junction Boxes
Limit Switches	Terminals
Photoelectric Switches	Solar Connectors
PLCs	
Proximity Switches	
Safety Limit Switches	
Signal Conditioning	



Visit: www.imopc.com

**IMO Precision Controls Limited**

1000 North Circular Road
Staples Corner,
London NW2 7JP
United Kingdom

Tel: +44 (0)20 8452 6444
Fax: +44 (0)20 8450 2274
Email: imo@imopc.com
Web: www.imopc.com

IMO Automazione

Via Ponte alle Mosse, 61
50144 Firenze (FI),
Italia

Tel: 800 930872
Fax: 8000 452 6445
Email: imo-it@imopc.com
Web: www.imopc.it

IMO Russia

Office N° 4063
9, Zemlyanoy Val, 105064
Moscow
Russia

Tel: 8 800 100 8540
7 (495) 9679322
Fax: 8 800 100 8541
+44 208 450 2274
Email: sales@imopc.com
Web: www.imopc.com

IMO Jeambrun Automation SAS

Centre D'Affaires Rocroy
30, Rue de Rocroy
94100 Saint-Maur-Des-Fosses
France

Tel: 0800 912 712
0 1 45 13 27 81
Fax: +8000 452 6445
+44 208 450 2274
Email: imo-fr@imopc.com
Web: www.imojeambrun.fr

IMO Canada

Unit 32 - B-North
18 Strathearn Avenue,
Brampton, ON L6T 4Y2
Canada

Tel: +905 799 9273
Fax: +905 799 0450
Email: imo-ca@imopc.com
Web: www.imopc.com

IMO Pacific Pty Ltd

1/34 Fallon Road
Landsdale
Perth WA 6065
Australia

Tel: +61 (0)8 9302 5246
Fax: +61 (0)8 9303 9908
Email: sales@imopacific.com.au
Web: www.imopacific.com.au