



Architectural Seals

Introduction 1 - 5

Compression Seals 6 - 9

Door Bottom Seals 10 - 15

Threshold Plates 16 - 20

Brush Seals 21 - 24

Magnetic Seals 25 - 26

Perimeter Seals 27 - 33

Drop Seals 34 - 45

**Speciality Seals &
Finger Protection** 46 - 48

**Additional Information &
Comprehensive Support** 49 - 53

Fire and smoke protection measures are essential, life-saving precautions in a building. What's more, they protect the property from the devastating consequences of the fire itself, and the damaging effects of hot and cold smoke. So it's essential to get the product selection right, every time.

Lorient is a pioneering company with a respected reputation for designing and manufacturing a wide range of products for fire and smoke containment. Products are also designed with acoustic, thermal and weather containment in mind, as well as accessibility – so you can be assured that a Lorient system provides an integrated, cost-effective solution.

With 35 years' experience and accumulated knowledge, we pride ourselves on offering ground-breaking innovations, underpinned by technical excellence and exceptional quality. Our dedicated R&D centre not only generates successful product developments for Lorient; it also allows us to work in partnership with customers to develop and test their own products too. Our indicative fire test furnace is particularly popular, giving customers real insight into their own products' performance and helping to save substantial testing costs. Our brand new state-of-the-art acoustic transmission suite, commissioned in 2013 features the latest Brüel & Kjær sound measurement technology. It was designed and purpose-built to meet the requirements of BS EN ISO 10140 – Laboratory measurement of sound insulation of building elements.

Always keen to keep raising the bar, we are committed to gaining third party certification for our products wherever a suitable scheme exists. Many products hold CERTIFIRE certification, and we also hold approvals from both the BBA and IFC.

We embrace the highest management standards too, and hold both BS EN ISO 9001:2008 and BS EN ISO 14001:2004 certificates for our quality and environmental management systems. Achieving ISO 14001 is just one part of our ongoing commitment to operate in a sustainable way: many initiatives are planned and already underway to reduce materials and energy usage, as well as waste.









In addition to our UK and Europe head office, we have a number of operations around the world; in North America, Hong Kong, Singapore and Australia. Furthermore, we have strong links in India and the Middle East, which means that we're able to deliver the right solutions locally to our customers throughout the world. By keeping abreast of technical developments and changes to codes, regulations and standards across the continents, we can ensure we're always providing the highest level of expertise. From advice to testing, new product development to manufacture – we work best in partnership with you.

The Lorient Architectural Seals range incorporates a variety of complementary door sealing systems including perimeter seals, drop seals, threshold plates, door bottom seals plus much more. These seals can provide outstanding protection for all four sides of the door against sound, smoke, rain, fire, light, draughts, dust and even insects.

Manufactured to the highest quality, Lorient Architectural Seals have been designed and tested for a host of different sectors including commercial, industrial and public buildings. Many of these sealing systems can be adjusted without the need to remove the door.

At-a-Glance Seal Function

The following icons are used throughout this brochure to give clear and easy recognition of a particular seal's function or possible application. Use of the icons does not necessarily indicate that test evidence exists. Please check with the Lorient Technical team.

-  sound
-  draughts and dust
-  smoke
-  light
-  weather
-  fire
-  insects
-  wheelchair friendly
-  will meet the acoustic requirements of Approved Document E

Product Illustrations

All dimensions in this brochure are in millimetres.

Acoustic sealing systems for door assemblies

Wherever noise influences human activity, effective acoustic sealing is essential. Whether preserving the confidentiality of discussions in a private office or doctor's surgery, or reducing noise from adjacent rooms in hotels; preservation of privacy is paramount. Building regulations provide guidelines for acoustic performance of door assemblies in a number of situations.

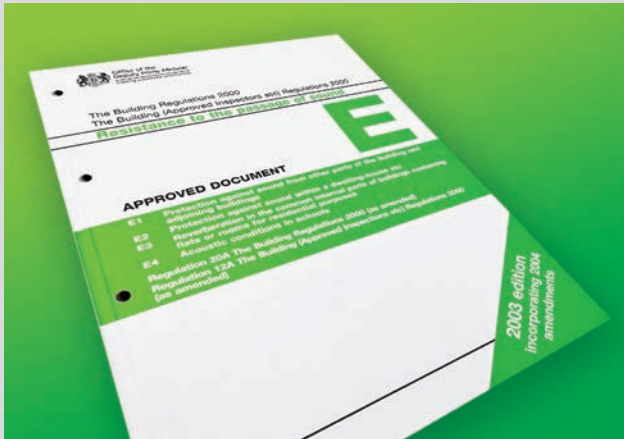

Door assemblies form an integral part of buildings. While there must be gaps around the perimeter of a door for it to operate, these gaps also enable fire, smoke and sound to pass through.

Sealing the gaps around a door is crucial to reduce the amount of sound entering or leaving a room. Wherever noise influences human activity, effective acoustic sealing is essential.

Approved Document E to the Building Regulations (England and Wales) now gives specific acoustic performance requirements for door assemblies in a number of situations. Requirement E1 states that, "dwelling-houses, flats and rooms for residential purposes, shall be designed and constructed in such a way that they provide reasonable resistance to sound from other parts of the same building and from adjoining buildings."

Clauses 2.26, 4.20 and 6.6 of the Document read:

"Ensure that any door has good perimeter sealing (including the threshold where practical), and a minimum mass per unit area of 25kg/m² or a minimum sound reduction index of 29dB Rw (measured according to BS EN ISO 10140-2: 2010 and rated according to BS EN ISO 717-1:1997). The door should also satisfy the Requirements of Building Regulations Part B – Fire safety."

Approved Document E also covers acoustic conditions in schools. Requirement E4 states:

"Each room or other space in a school building shall be designed and constructed in such a way that it has the acoustic conditions and the insulation against disturbance by noise appropriate to its intended use."

Section 8 of Document E recognises Building Bulletin 93, "The Acoustic Design of Schools" as an Approved Document, and the normal way of satisfying Requirement E4.

This document gives "performance standards for airborne sound insulation between circulation spaces and other spaces used by students – minimum sound reduction index Rw:

"All spaces except music rooms **30dB**

Music rooms **35dB"**

It is therefore now essential to take into account the requirements of Approved Document E when specifying and installing sealing systems for door assemblies.

Lorient provides a wide range of seals that offer excellent resistance to airborne sound. Many also provide fire and smoke protection and thermal containment.

Acoustic Results

The acoustic results are given as a dB Rw rating based on actual test evidence. The graphs show indicative sound curves over a range of frequencies. Actual sound curves for individual seals are available on request.

Standards and Regulations

There are several aspects of the Building Regulations that must be considered. These Approved Documents are not mandatory, they are only guidance; however, they are considered to be the usual means of proving compliance with the Building Regulations:



Fire and Smoke Containment:

The requirements for fire and smoke containment with respect to “means of escape” are contained in Approved Document B to the Building Regulations (England and Wales), Section 2 of the Scottish Technical Handbooks and Technical Booklet E to the Building Regulations (Northern Ireland).

Acoustic Containment:

Approved Document E to the Building Regulations (England and Wales) now gives specific acoustic performance requirements for door assemblies in a number of situations. Acoustic containment is also covered in Section 5 of the Scottish Technical Handbooks and Technical Booklets G and G1 to the Building Regulations (Northern Ireland).

Accessibility:

Approved Document M to the Building Regulations (England and Wales), section 4 of the Scottish Guidance Documents, and Technical Booklet R to the Building Regulations (Northern Ireland) relate to accessibility for all persons entering and using buildings. These Documents specify the size and location for glazed panels in doors in various situations, in order to promote safety and accessibility. Visual contrast on the leading edge of doors is also included, as are opening and closing forces for ease of door operation, threshold height and door width requirements.

Compression Seals



Magnetic Seals

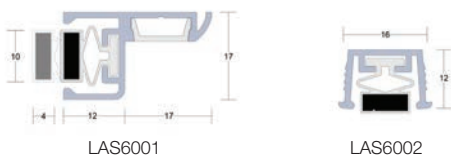

Perimeter Seals

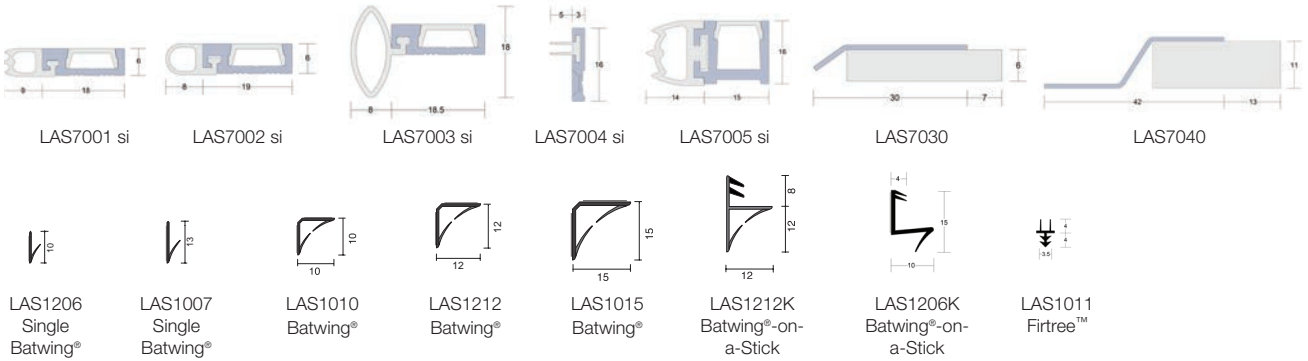

Drop Seals



Threshold Seals

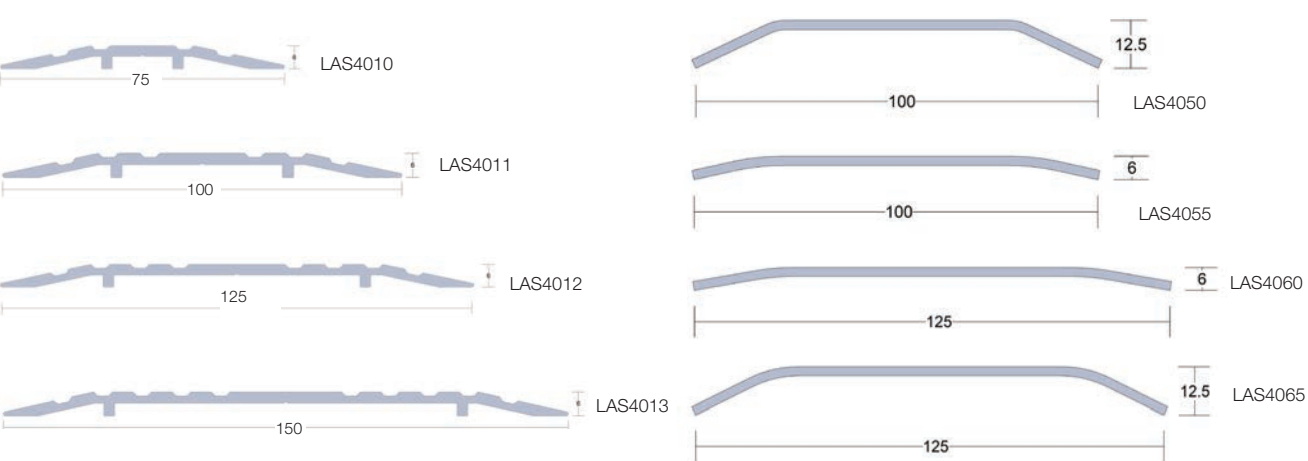

Product dimensions are in mm.
Not to scale.

Door Bottom Seals

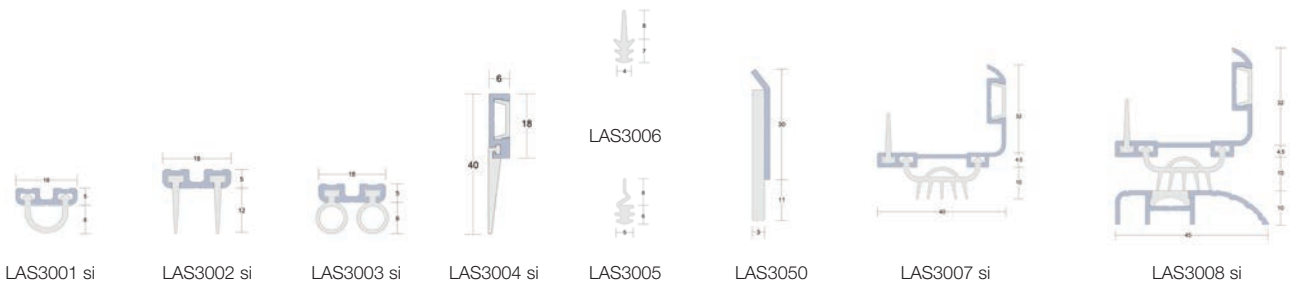

Brush Seals



Finger Guards & Speciality Seals

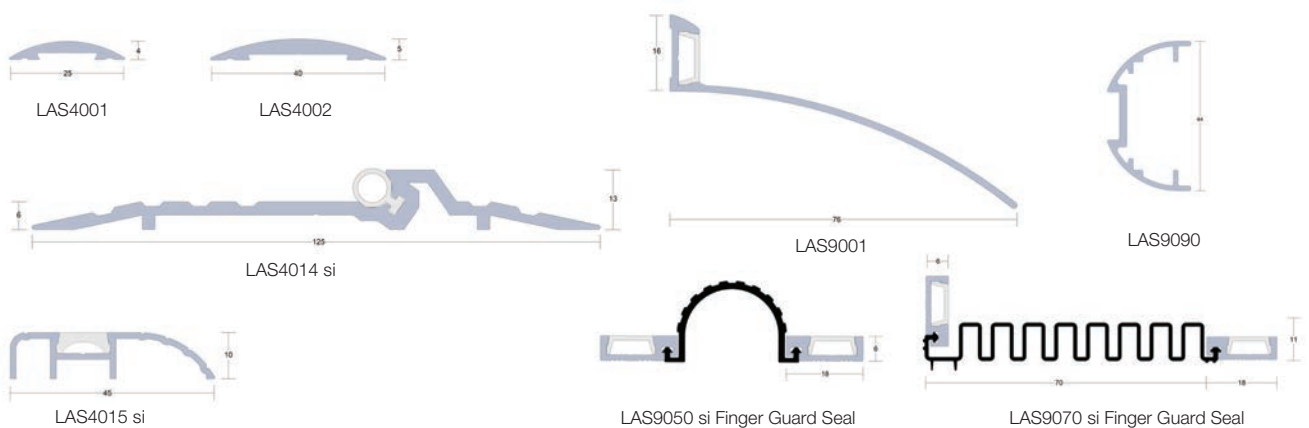

LAS1020, LAS1030 and LAS1040 Compression Seals

Light Duty

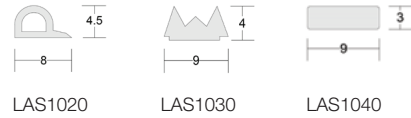

LAS1020

LAS1030

LAS1040

Three superior quality, self adhesive door and window frame weatherstrips, which provide a compression seal.

Location

Mounted on the doorstop for single swing doors.

Min/max gap size

LAS1020 - 3mm/4mm.

LAS1030 - 2mm/3.5mm.

LAS1040 - 2mm/3mm.

Seal material

LAS1030 and LAS1040 – soft EPDM foam.

LAS1020 – soft PVC foam.

Standard lengths

LAS1020 – 6m and 100m rolls.

LAS1030 – 6m and 100m rolls.

LAS1040 – 6m rolls.

Fixing

Self-adhesive tape.

Note: contact surfaces must be clean, smooth and, if painted, well cured.

Colours

White or brown.



LAS1020

LAS1025 and LAS1046 Compression Seals

Light Duty

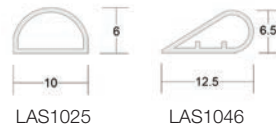
 73NN File Number:
 R16586
 (LAS1046)

Two superior quality, self-adhesive profiles for doors and window frames, which provide a compression seal.

Location

LAS1025 – mounted on doorstep or can be recessed by up to 2mm on single swing doors.

LAS1046 – mounted on doorstep for single swing doors.

Min/max gap size

LAS1025 – 3mm/4mm (rebated).

LAS1025 – 3mm/5.5mm (non-rebated).

LAS1046 – 3mm/5mm.

Seal material

LAS1025 – co-extruded elastomeric bulb with PVC spine.

LAS1046 – silicone.

Standard lengths

LAS1025 – 1m and 2.1m lengths.

LAS1046 – 100m reels.

Fixing

Self-adhesive tape. Note: contact surfaces must be clean, smooth and, if painted, well cured.

Colours

LAS1025 – white or brown.

LAS1046 – white, dark brown or black.



LAS1025

LAS1002 si, LAS1005 si and LAS1009 si Bulb Seals

Key benefits

Durable, silicone bulb seal for acoustic performance and smoke containment.

Push fits quickly and easily into a 2mm wide x 4mm deep groove.

Location

Head and jambs of single swing doors.

Use with

Practically any door bottom or drop seal.

Min/max gap size

3mm/6mm.

Seal material

Flexible silicone rubber.

Standard lengths

100m reels.

Fixing

Interference fit into a kerf 2mm wide and minimum 4mm deep.

Colours

Grey, dark brown or black.



LAS1005 si



LAS1002 si

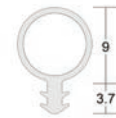

LAS1009 si



LAS1002 si

LAS1606 Bulb Seal

A bulb type buffer seal with a semi-rigid spine for kerf fitting.

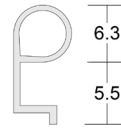

LAS1606

- **Location**
Head and jambs of single swing doors.
- **Use with**
Practically any threshold seal.
- **Min/max gap size**
3mm/6mm.
- **Seal material**
Co-extruded elastomeric bulb with PVC spine.
- **Standard lengths**
5m and 10m rolls.
- **Fixing**
Interference fit into a kerf 2mm wide and minimum 6mm deep.
- **Colours**
White, grey, light brown or black.



LAS1606

LAS3001 si, LAS3002 si and LAS3003 si Door Bottom Seals

Medium Duty



Door bottom seals ideal for acoustic and smoke containment. See Acoustic Sealing Systems for Door Assemblies manual for further details.

Location

Single and double swing doors.

Use with

Practically any threshold plate.

Min/max gap size

LAS3001 si – 6mm/13mm.

LAS3002 si – 10mm/17mm.

LAS3003 si – 7mm/13mm.

Seal material

Flexible silicone rubber.

Standard lengths

1m and 2.1m. Other lengths to special order.

Fixing

Face-fixed, semi-rebated or fully rebated.

Self-tapping wood screws are supplied (self-drilling and self-tapping screws for metal construction available on request). Fixing holes are pre-drilled. Once the aluminium carrier is fixed, the rubber gasket slides easily into place.

Note: these seals cannot be adjusted once fitted.

Finish

Silver anodised aluminium with grey silicone insert.

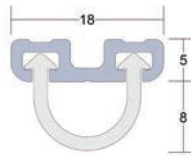

LAS3001 si

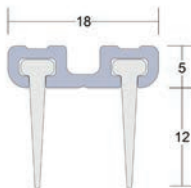

LAS3002 si

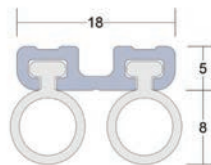

LAS3003 si



LAS3001 si

(Shown with LAS4001)

LAS3004 si Door Bottom Seal

Heavy Duty



A heavy duty sweep action door bottom seal.

Key benefits

- Hard wearing and durable seal.
- Slim-line, aesthetic design.
- Seal screw-fixed without self-adhesive.

Location

- Single and double leaf doors.
- Up and over garage doors.
- Roller shutter doors.

Use with

- Practically any threshold plate.

Min/max gap size

- 10mm/22mm.

Seal material

- Flexible silicone rubber.

Standard lengths

- 1m and 2.1m. Other lengths to special order.

Fixing

- Self-tapping wood screws are supplied (self-drilling and self-tapping screws for metal construction available on request). Fixing holes are pre-drilled and slotted to allow the seals to be adjusted and positioned accurately.

Finish

- Silver anodised aluminium with grey cover strip and grey silicone rubber blade. Also available in bronze anodised aluminium with black cover strip and black silicone rubber blade.

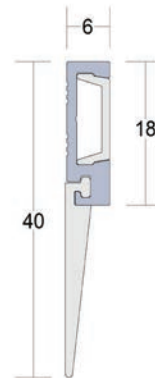

LAS3004 si

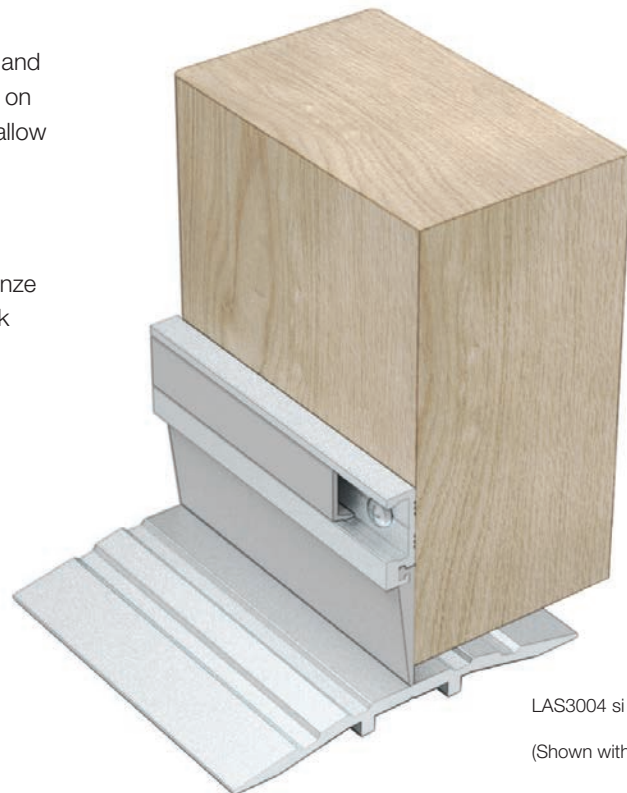

LAS3004 si

(Shown with LAS4010)

LAS3005 and LAS3006 Door Bottom Seals

Medium Duty



Medium duty door bottom seals. Designed for use in door frames providing a wiping action to seal the gaps from draught or rain.



LAS3005



LAS3006

Key benefits

Slim-line, aesthetic design.

Location

Single and double leaf doors.
Up and over garage doors.
Roller shutter doors.

Use with

Practically any threshold plate.

Min/max gap size

4mm/7mm.

Seal material

EPDM material.

Standard lengths

100m. Other lengths to special order.

Fixing

Interference fit into appropriate sized kerf.

Finish

Black.



LAS3005

(Shown with LAS4002)



LAS3006

(Shown with LAS4002)

LAS3007 si Door Bottom Seal

Heavy Duty



A weather proof seal which can be fitted without removing the door, and can be used with a choice of threshold plates.

Key benefits

Storm-proof, multi-blade seal to deflect water.
 Can be fitted without removing the door.
 Concealed fixings, pre-drilled and slotted holes on LAS3007 si for easy adjustment.
 Durable, anodised aesthetic finish.

Location

Single and double leaf doors.
 Roller shutter doors.
 Up and over doors.

Use with

Practically any threshold plate.

Min/max gap size

12mm/14mm.

Seal material

Flexible silicone rubber.

Standard lengths

1m and 2.1m. Other lengths to special order.

Fixing

Self-tapping wood screws are supplied (self-drilling and self-tapping screws for metal construction available on request). Fixing holes are pre-drilled and slotted to allow the seals to be adjusted and positioned accurately. A PVC cover strip to conceal fixings is supplied.

Finish

Silver anodised aluminium with grey cover strip and grey silicone rubber gasket. Also available in bronze anodised aluminium with black cover strip and black silicone rubber blade.

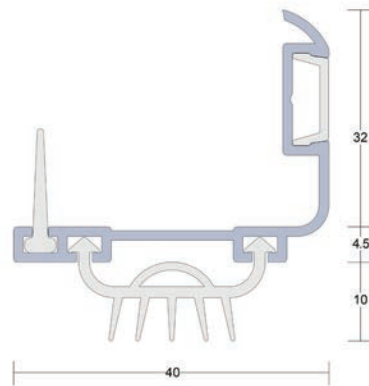

LAS3007 si



LAS3007 si

(Shown with
 LAS4010)

LAS3008 si Door Bottom Seal with Threshold Plate
 Medium Duty

A storm-proof seal combination consisting of the LAS3007 si door bottom seal and LAS4015 threshold plate. The plate may be filled with slurry to help keep it in position when crossed by heavy industrial traffic.

Key benefits

- Storm-proof, multi-blade seal to deflect water.
- Flexible bedding gasket on plate to eliminate vibration and noise and provide cushioning on uneven surfaces.
- Can be fitted without removing the door.
- Concealed fixings, pre-drilled and slotted holes on LAS3007 si for easy adjustment.
- Durable, anodised aesthetic finish.

Location

- Single swing doors.
- Roller shutter doors.
- Up and over doors.

Min/max gap size

22mm/24mm.

Seal material

- LAS3007 si – Flexible silicone rubber.
- LAS4015 – Extruded aluminium with and PVC cover strip.

Standard lengths

1m and 2.1m. Other lengths to special order.

Fixing

LAS3007 si – Self-tapping wood screws are supplied (self-drilling and self-tapping screws for metal construction available on request). Fixing holes are pre-drilled and slotted to allow the seals to be adjusted and positioned accurately.

A PVC cover strip to conceal fixings is supplied.
 LAS4015 – Fixing screws are supplied. PVC cover strip to conceal fixings is supplied.

Finishes

LAS3007 si – Silver anodised aluminium with grey cover strip and grey silicone rubber gasket or bronze anodised aluminium with black cover strip and black silicone rubber gasket.

LAS4015 – Silver anodised aluminium with grey cover strip or bronze anodised aluminium with black cover strip.

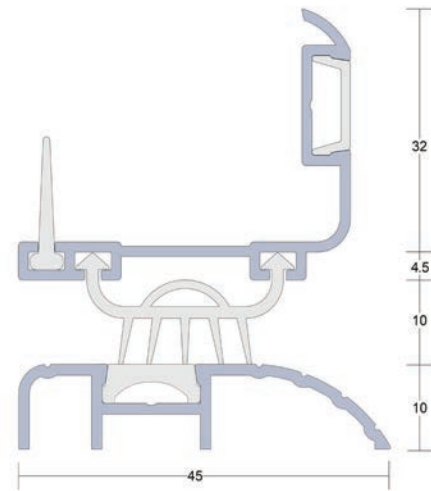

LAS3008 si



LAS3008 si

LAS3050 Door Bottom Seal

Heavy Duty

Key benefits

A low maintenance seal, extremely resistant to weathering or aggressive commercial environments. Impervious to most chemicals, solvents, cleaning fluids and disinfectants.

Location

Single and double leaf doors.
Up and over garage doors.
Roller shutter doors.

Use with

Any stainless steel threshold plate.

Min/max gap size

5mm/10mm.

Seal material

Foamed silicone rubber.

Standard lengths

1m and 2.1m. Other lengths to special order.

Fixing

Fixing screws are supplied, fixing holes are pre-drilled and slotted to allow the seals to be adjusted and positioned accurately.

Finish

Grade 304 stainless steel with grey silicone rubber.



LAS3050



LAS3050

(Shown with LAS4050)

LAS4001 and LAS4002 Threshold Plates

Medium Duty



These plates, when used in conjunction with door bottom seals prevent rain, draught, and smoke penetration.

- **Location**
Single and double swing doors.
- **Use with**
Practically any drop or door bottom seal.
- **Material**
Extruded aluminium.
- **Standard lengths**
1m and 2.1m. Other lengths to special order.
- **Fixing**
Fixing screws are supplied.
- **Finishes**
Silver or bronze anodised aluminium.
Special colours can be supplied using a powder coated finish for additional aesthetics.



LAS4001

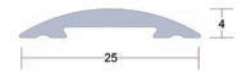

LAS4001

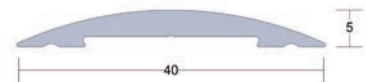

LAS4002

LAS4010, LAS4011, LAS4012 and LAS4013 Threshold Plates

Medium Duty



Low profile threshold plates, only 6mm high.

Key benefits

These plates, when used in conjunction with drop or door bottom seals prevent rain, draught, and smoke penetration. Low profile threshold plates ideal for wheeled traffic.

Location

Single and double swing doors.

Use with

Practically any drop or door bottom seal.

Material

Extruded aluminium.

Standard lengths

1m and 2.1m. Other lengths to special order.

Fixing

Fixing screws are supplied.

Finishes

Silver anodised aluminium.

Bronze anodised aluminium.



LAS4010

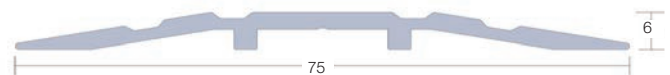

LAS4010

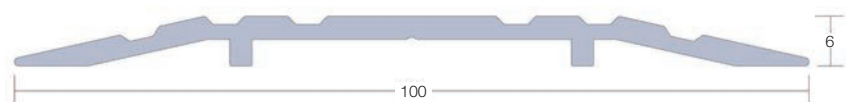

LAS4011

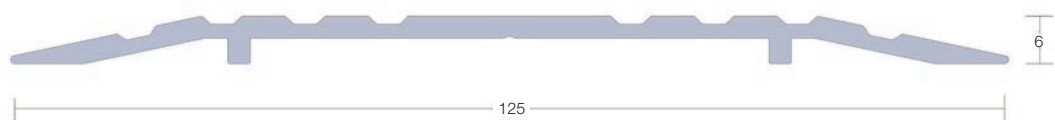

LAS4012

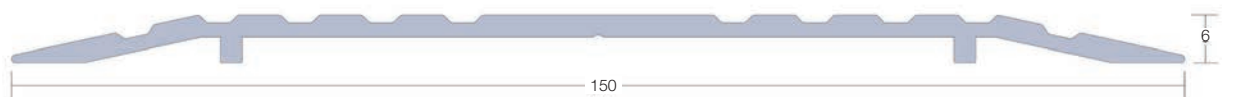

LAS4013

LAS4014 si Threshold Plate

Heavy Duty



Suitable for outward opening doors to prevent rain, draught, light and noise penetration.

Key benefits

Durable anodised aesthetic finish.
High performance silicone compression seal helps resist rain, light, dust and noise penetration.

Location

Single and double leaf outward opening doors.

Use with

Practically any drop or door bottom seal and in conjunction with any perimeter seal to provide a total door sealing solution.

Material

Extruded aluminium and silicone gasket.

Standard lengths

1m and 2.1m. Other lengths to special order.

Fixing

Fixing screws are supplied.

Finishes

Silver anodised aluminium with grey silicone rubber gasket.
Bronze anodised aluminium with black silicone rubber gasket.

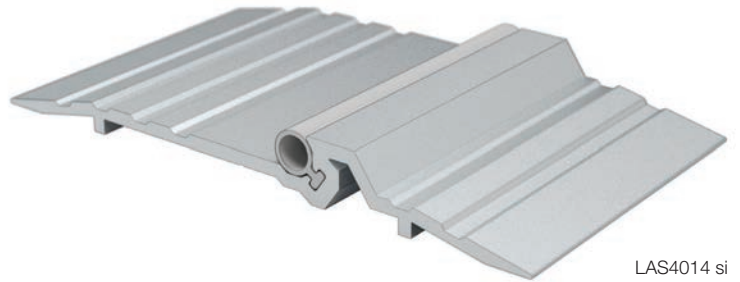

LAS4014 si

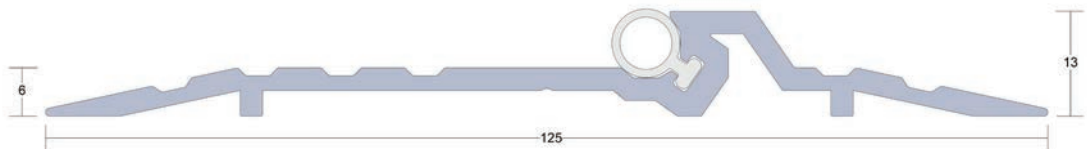

LAS4014 si

LAS4015 si Threshold Plate

Heavy Duty



Suitable for outward opening doors to prevent rain, draught, light and noise penetration.

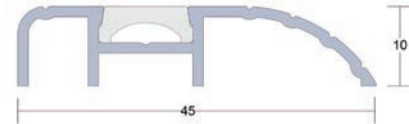

LAS4015 si

Key benefit

Durable anodised aesthetic finish.

Location

Single and double leaf outward opening doors.

Use with

Practically any threshold (door bottom) seal and in conjunction with any perimeter seal to provide a total door sealing solution.

Material

Extruded aluminium, silicone gasket and PVC cover strip.

Standard lengths

1m and 2.1m. Other lengths to special order.

Fixing

- Fixing screws are supplied.

Finishes

Silver anodised aluminium with grey silicone rubber gasket and grey cover strip.

Bronze anodised aluminium with black silicone rubber gasket and black cover strip.



LAS4015 si

LAS4050, LAS4055, LAS4060 and LAS4065 Threshold Plates

Heavy Duty



Stainless steel threshold plates, when used in conjunction with threshold seals prevent rain, draught and smoke penetration. Impervious to most chemicals, solvents, cleaning fluids and disinfectants. 6mm rise variants ideal for wheeled traffic.

Location

Single and double swing doors.

Use with

Practically any threshold seal.

Material

Grade 304 stainless steel.

Standard lengths

1m and 2.1m. Other lengths to special order.

Fixing

Stainless steel fixing screws are supplied, fixing holes are pre-drilled.

Finish

Grade 304 stainless steel.



LAS4065

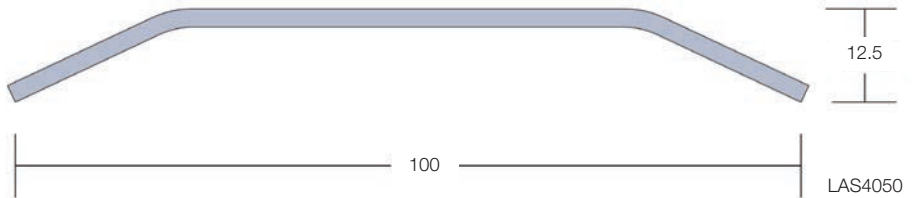

LAS4050

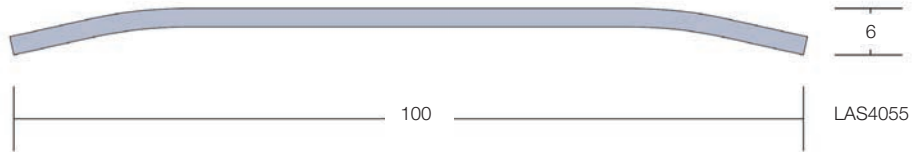

LAS4055

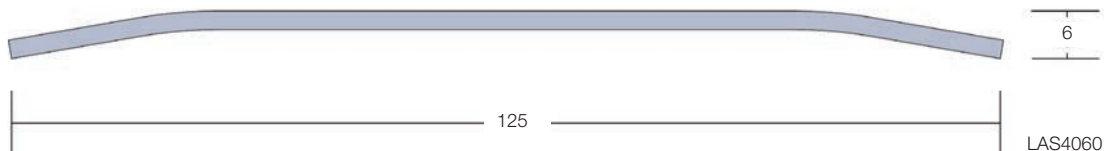

LAS4060

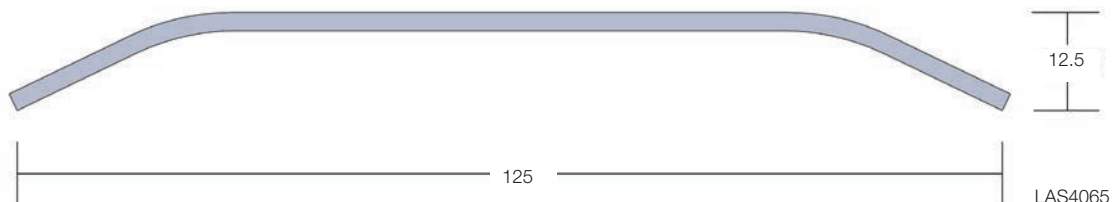

LAS4065

LAS5010, LAS5015, LAS5020, LAS5025 and LAS5030 Brush Seals

Medium Duty

Location

Head, jambs, threshold and meeting stiles of single and double swing doors, and sliding doors.

Head, jambs and threshold of revolving doors, up and over doors, and roller shutter doors.

Use with

Any threshold plate.

Min/max gap size

LAS5010: 10mm/13mm.

LAS5015: 13mm/19mm.

LAS5020: 19mm/25mm.

LAS5025: 25mm/35mm.

LAS5030: 35mm/45mm.

Seal material

Polypropylene brush filaments, UV stabilised.

Standard lengths

1m, 2.1m and 3m. Other lengths to special order.

Fixing

Heavy duty self-adhesive tape.

Screw fixing recommended: screws not supplied.

Finishes

Silver or bronze anodised aluminium with black brush filaments.

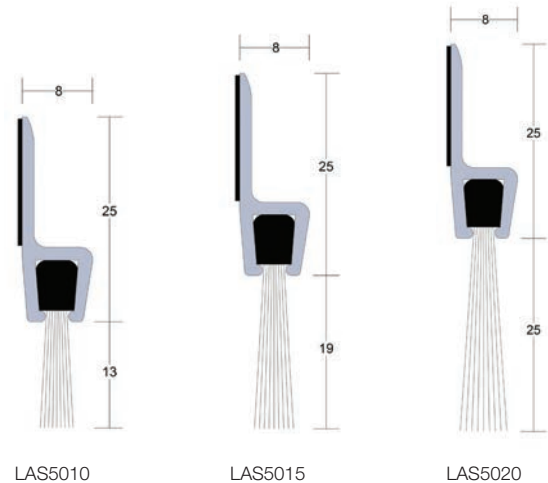

LAS5010

LAS5015

LAS5020

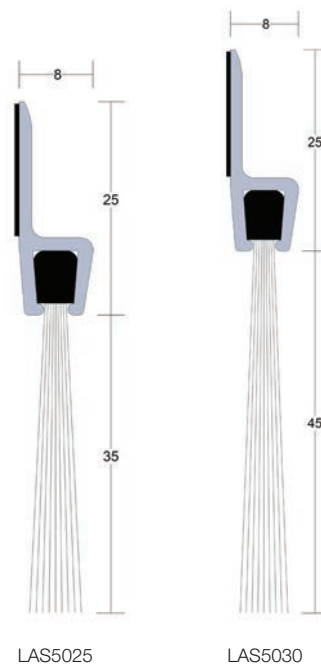

LAS5025

LAS5030



LAS5020

LAS5035, LAS5040, LAS5045, LAS5050 and LAS5055 Brush Seals

Heavy Duty

Location

Head, jambs, threshold and meeting stiles of single and double swing doors, and sliding doors.

Head, jambs and threshold of revolving doors, up and over doors, and roller shutter doors.

Use with

Any threshold plate.

Min/max gap size

LAS5035: 20mm/40mm. LAS5040: 40mm/60mm.

LAS5045: 60mm/80mm. LAS5050: 80mm/120mm.

LAS5055: 120mm/150mm.

Seal material

Polypropylene brush filaments, UV stabilised.

Standard lengths

1m, 2.1m and 3m. Other lengths to special order.

Fixing

Heavy duty self-adhesive tape.

Screw fixing recommended:

screws not supplied.

Finishes

Silver anodised aluminium with black brush filaments.
Bronze anodised available to special order.

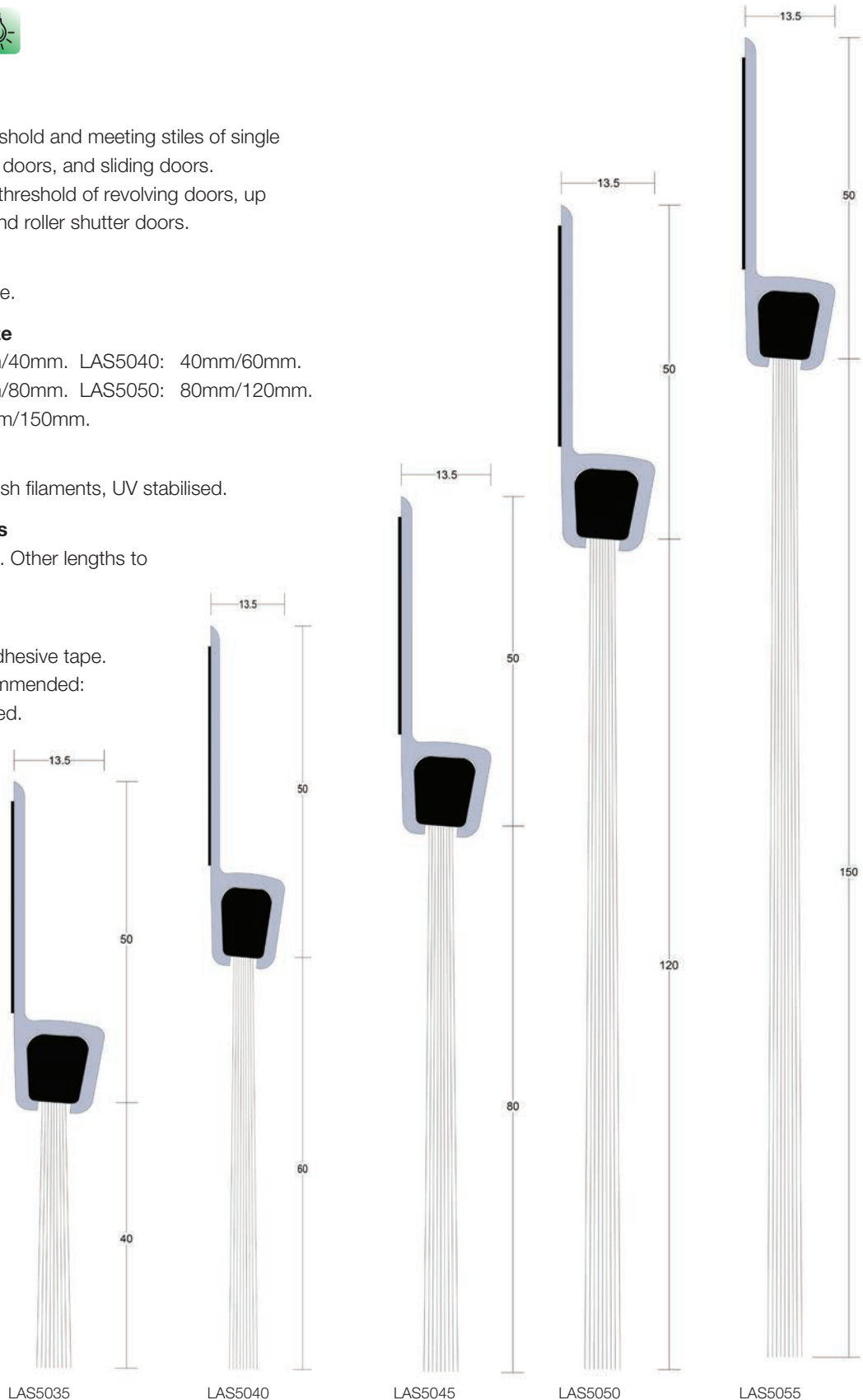

LAS5060, LAS5065 and LAS5070 Brush Seals
 Medium Duty

- **Location**
 Sliding doors.
- **Min/max gap size**
 LAS5060: 24mm/30mm.
 LAS5065: 32mm/40mm.
 LAS5070: 39mm/50mm.
- **Seal material**
 Polypropylene brush filaments, UV stabilised.
- **Standard lengths**
 1m, 2.1m and 3m. Other lengths to special order.
- **Fixing**
 Heavy duty self-adhesive tape.
 Screw fixing recommended: screws not supplied.
- **Finishes**
 Silver or bronze anodised aluminium with
 black brush filaments.

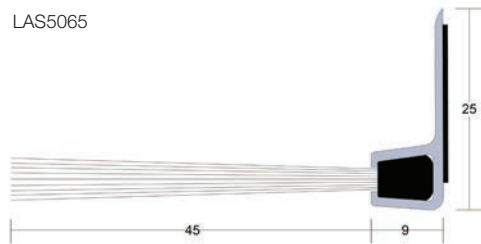
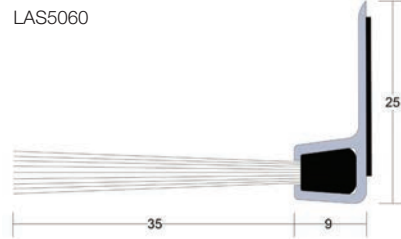
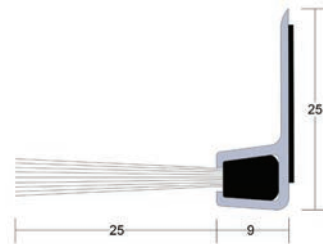

LAS5070



LAS5060

LAS5075, LAS5080 and LAS5085 Brush Seals
 Medium Duty

Location

A variety of industrial door applications requiring angled brushes.

Min/max gap size

LAS5075: 19mm/25mm.

LAS5080: 25mm/35mm.

LAS5085: 35mm/45mm.

Seal material

Polypropylene brush filaments, UV stabilised.

Standard lengths

1m, 2.1m and 3m. Other lengths to special order.

Fixing

Heavy duty self-adhesive tape.

Screw fixing recommended: screws not supplied.

Finishes

Silver or bronze anodised aluminium with black brush filaments.

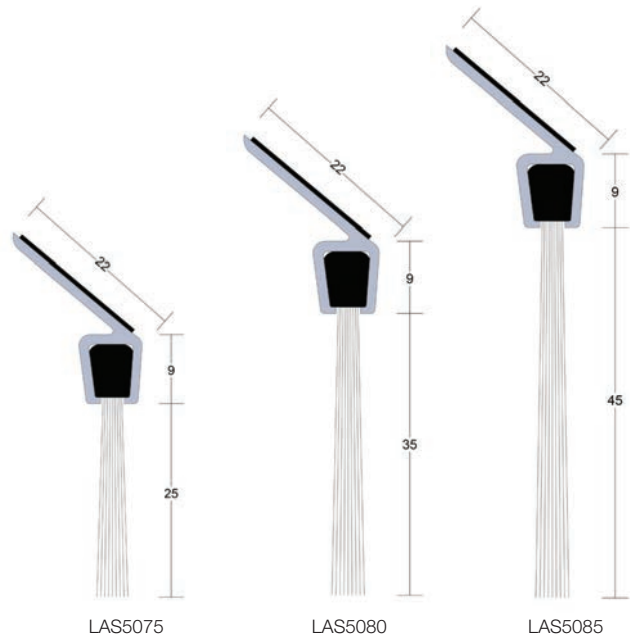

LAS5075

LAS6001 Magnetic Perimeter Seal

Medium Duty



Refrigeration-type vinyl magnetic strip in anodised aluminium housing. The strip holds the door closed so latches are not always required.

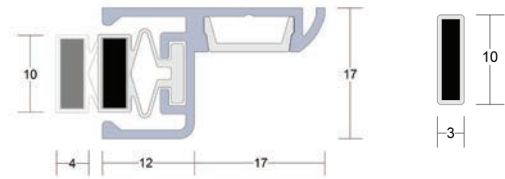

LAS6001

LAS6011

Key benefits

- Concealed fixings, pre-drilled and slotted holes for easy adjustment.
- Easily installed without removing the door.
- Can be used as a stop.
- Can be supplied with magnetic keeper strip, LAS6011 which has an aggressive self-adhesive backing for fixing into a groove on timber doors.

Location

Head and jambs of single swing steel clad doors and timber doors (use with LAS6011).

Seal material

- LAS6001 – flexible with magnetic core.
- LAS6011 – PVC sleeve with magnetic insert.

Standard lengths

1m and 2.1m. Other lengths and single doorset packs consisting of 1 x 1m and 2 x 2.1m available to special order.

Fixing

Self-tapping wood screws are supplied (self-drilling and self-tapping screws for metal construction available on request). Fixing holes are pre-drilled and slotted to allow the seals to be adjusted and positioned accurately. A PVC cover strip to conceal fixings is supplied. Note: order LAS6011 magnetic keeper strip for use with timber doors. Supplied with self-adhesive backing as standard.

Finish

LAS6001 – silver anodised aluminium with grey insert or bronze anodised aluminium with black insert.
 LAS6011 – brown, cream or maple PVC sleeve. Other colours, including woodgrain finishes, to special order.



LAS6001 & LAS6011

LAS6002 Magnetic Seal for Meeting Stiles

Medium Duty



The LAS6002 magnetic seal has sufficient magnetic strength to hold the door closed so latches are not always required.

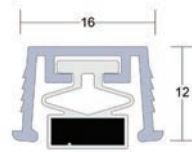

LAS6002

Location

Rebated meeting stiles of double leaf doors.
Sliding doors.

Seal material

Grey flexible with black magnetic core.

Standard lengths

2.1m. Other lengths to special order.

Fixing

The aluminium profile is toothed to lock into a 16mm x 12mm groove. The magnetic seals are also 'locked' in to prevent creeping.

Finish

Silver anodised aluminium with grey insert.

Black insert to special order.

Note: not suitable where centre latching is required.



LAS6002

LAS1010, LAS1212, LAS1015, LAS1212K, LAS1206, LAS1206K and LAS1007 Batwing® Seals

Medium Duty



Primarily designed for upgrading existing fire resistant doors to provide additional protection against smoke up to 200°C. Can be fitted with minimal disruption to the door assembly. The Batwing® seal is also a highly effective acoustic seal when tested in accordance with BS EN ISO 10140-2: 2010.

Key benefits

- Curved fin shape minimises open/closing resistance.
- Flexible elastomeric fins ensure the original shape is maintained, providing ongoing performance and durability in service.
- Symmetrical design ensures fins are always in contact with two surfaces of door leaf, creating an air chamber to provide excellent acoustic performance.
- Tested for acoustic performance with BS EN ISO 10140-2: 2010.
- Meets the smoke leakage performance requirements of BS9999 when tested in accordance with BS 476 Pt 31.1: 1983.
- Tested for up to 60 minutes under conditions of BS 476: Pt.20/22: 1987 without compromising fire resistance.
- Variety of standard colours to blend with door designs.

Location

Head and jambs of single and double leaf doors.

Use with

Practically any drop seal.

Min/max gap size

3mm/4mm.

Seal material

Co-extruded rigid back with flexible fins.

Standard lengths

1m, 2.1m and 3m. Single doorset pack consisting of 1 x 1m and 2 x 2.1m. Other lengths to special order.

Fixing

Supplied with strong self-adhesive tape, tested on many surfaces, including MDF. Groove size for LAS1212K is 9mm x 3mm.

Colours

Black, white, dark brown, light brown, grey, silver and cream, and now available in a clear finish.

Note: clear Batwing® will not prevent light penetration.

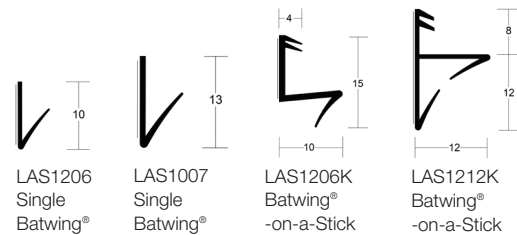

* Single Batwing® is not Certifire accredited

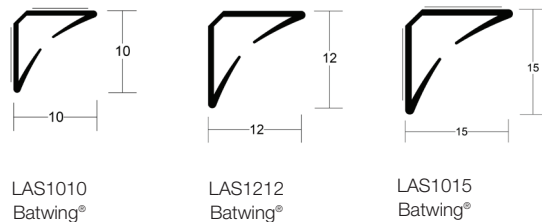

LAS1212 Batwing®

(Shown with drop seal LAS8001 si, LP1504 fire seal)

Acoustic performance

Weighted Sound Reduction (Rw): 31dB.

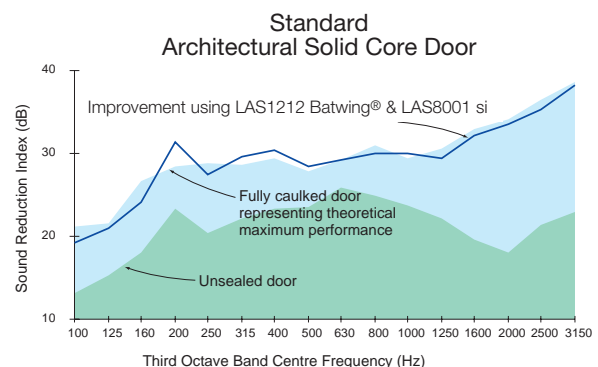

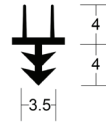
LAS1011 Firtree™ Seal

 LAS1011
Firtree™

A highly effective acoustic seal with smoke barrier performance up to 200°C.

Key benefits

- Tested for acoustic performance with BS EN ISO 10140-2: 2010.
- Meets the smoke leakage performance requirements of BS9999 when tested in accordance with BS 476 Pt 31.1: 1983.
- Tested for reliability, the seal completed 1,000,000 cycles without failure.

Location

Head and jambs of single and double leaf doors.

Use with

Practically any threshold seal. LAS8001 si or LAS8005 si recommended for optimum acoustic performance.

Min/max gap size

3mm/4mm. 6mm finned version available.

Seal material

Co-extruded rigid back with flexible fins.

Standard lengths

1m, 2.1m and 3m. Other lengths to special order.

Fixing

Interference fit into a kerf 3mm wide and minimum 4mm deep.

Colours

Black or white.

 LAS1011
Firtree™

(Shown with drop seal
LAS8001 si, LP1504
fire seal)

LAS7001 si and LAS7002 si Perimeter Seals

Medium Duty

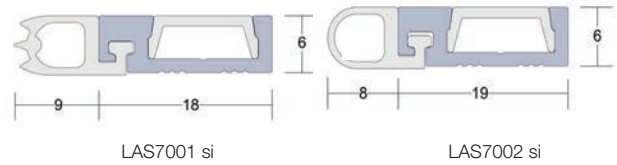

Acoustic seals designed to be fitted to existing door stops.

■ **Key benefits**

- Tested for acoustic performance with BS EN ISO 10140-2: 2010.
- Meets the smoke leakage performance requirements of BS9999 when tested in accordance with BS 476 Pt 31.1: 1983.
- Tested for reliability, the seal completed 1,000,000 cycles without failure.

■ **Location**

Head and jambs of single swing doors.

■ **Seal material**

Flexible silicone rubber.

■ **Standard lengths**

1m, 2.1m and 3m. Single doorset pack consisting of 1 x 1m and 2 x 2.1m. Other lengths to special order.

■ **Fixing**

Self-tapping wood screws are supplied (self-drilling and self-tapping screws for metal construction available on request). Fixing holes are pre-drilled and slotted to allow the seals to be adjusted and positioned accurately. A PVC cover strip to conceal fixings is supplied.

Finishes

Silver anodised aluminium with grey silicone rubber gasket. Bronze anodised aluminium with black cover strip and black gasket.

■ **Acoustic performance**

Weighted Sound Reduction Index up to (R_w): 31dB.

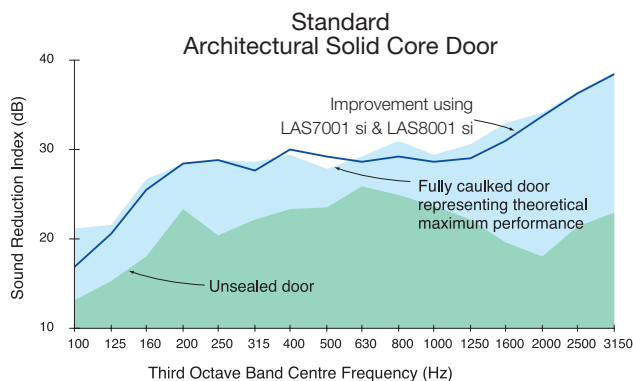

LAS7001 si



LAS7002 si

LAS7003 si Perimeter Seal

Medium Duty



The seal is squeezed between the door and the stop when the door is closed, thus compensating for warped or unevenly hung doors. See Acoustic Sealing Systems for Door Assemblies manual for further details.

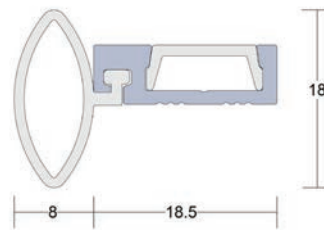

LAS7003 si

■ **Key benefits**

- Tested for acoustic performance with BS EN ISO 10140-2: 2010.
- Meets the smoke leakage performance requirements of BS9999 when tested in accordance with BS 476 Pt 31.1: 1983.
- Tested for reliability, the seal completed 1,000,000 cycles without failure.

■ **Location**

Head and jambs of single swing doors.

■ **Seal material**

Flexible silicone rubber.

■ **Standard lengths**

1m, 2.1m and 3m. Single doorset pack consisting of 1 x 1m and 2 x 2.1m. Other lengths to special order.

■ **Fixing**

Self-tapping wood screws are supplied (self-drilling and self-tapping screws for metal construction available on request). Fixing holes are pre-drilled and slotted to allow the seals to be adjusted and positioned accurately. A PVC cover strip to conceal fixings is supplied.

■ **Finishes**

- Silver anodised aluminium with grey cover strip and grey gasket.
- Bronze anodised aluminium with black cover strip and black gasket.

■ **Acoustic performance**

Weighted Sound Reduction Index (Rw): 31dB.



LAS7003 si

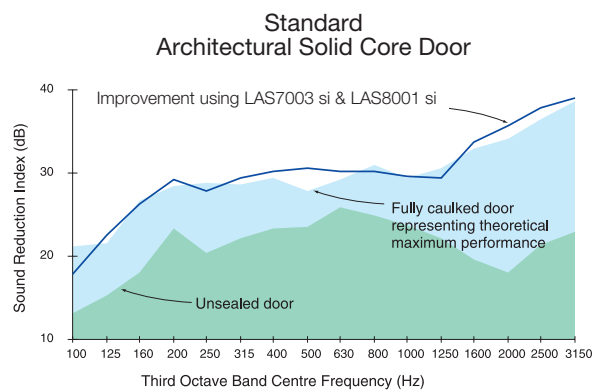

LAS7004 si Perimeter Seal

Medium Duty



Designed for timber doors with plain or rebated meeting stiles and where a centre latch is required. The leg of this seal can be cut out to accommodate the latch plate.

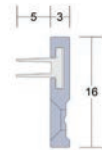

LAS7004 si

Key benefits

Tested for acoustic performance with BS EN ISO 10140-2: 2010.

Meets the smoke leakage performance requirements of BS9999 when tested in accordance with BS 476 Pt 31.1: 1983.

Tested for reliability, the seal completed 1,000,000 cycles without failure.

Location

Meeting stiles of single and double swing doors.
Sliding doors.
Revolving doors.

Seal material

Choose from:

- (i) 4mm projection twin elastomeric fins
- (ii) 6mm projection twin elastomeric fins

Note: twin elastomeric fins will provide optimum acoustic performance.

Standard lengths

1m and 2.1m. Other lengths to special order.

Fixing

Wood screws are supplied (self-tapping screws for metal frames are available on request). Fixing holes are pre-drilled and countersunk.

Finishes

Silver anodised aluminium with grey twin seal insert.

Bronze anodised aluminium with black twin seal insert.

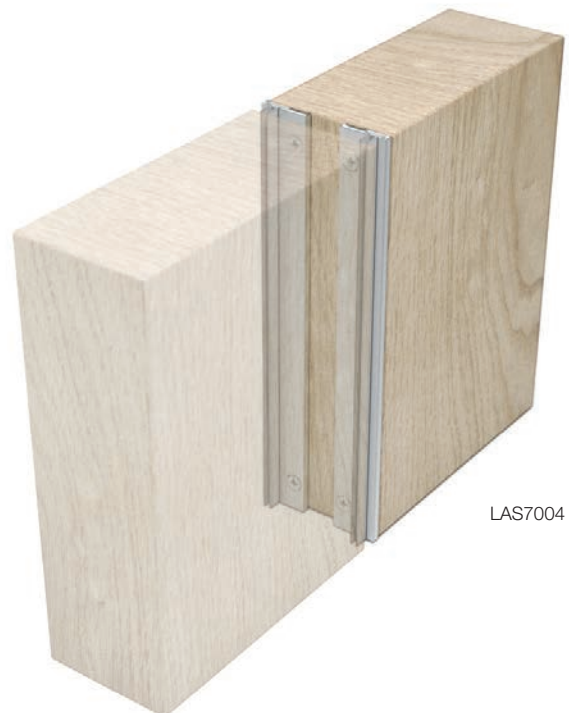

LAS7004 si

LAS7005 si Perimeter Seal

Medium Duty



A neat, compact perimeter seal with proven acoustic performance. See Acoustic Sealing Systems for Door Assemblies manual for further details.

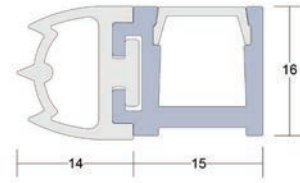

LAS7005 si

Key benefits

This seal can be used to replace the stop on steel or timber framed doors. To avoid excessive impact on the seal we recommend using a door closer to aid closing control.

Tested for acoustic performance with BS EN ISO 10140-2: 2010.

Location

Head and jambs of single swing doors.

Seal material

Flexible silicone rubber.

Standard lengths

1m, 2.1m and 3m. Single doorset pack consisting of 1 x 1m and 2 x 2.1m. Other lengths to special order.

Fixing

Self-tapping wood screws are supplied (self-drilling and self-tapping screws for metal construction available on request). Fixing holes are pre-drilled and slotted to allow the seals to be adjusted and positioned accurately. A PVC cover strip to conceal fixings is supplied.

Finishes

Silver anodised aluminium with grey cover strip and grey silicone rubber gasket.

Bronze anodised aluminium with black cover strip and black silicone rubber gasket.

Acoustic performance

Weighted Sound Reduction Index (Rw): 33dB.



LAS7005 si

Standard Architectural Solid Core Door

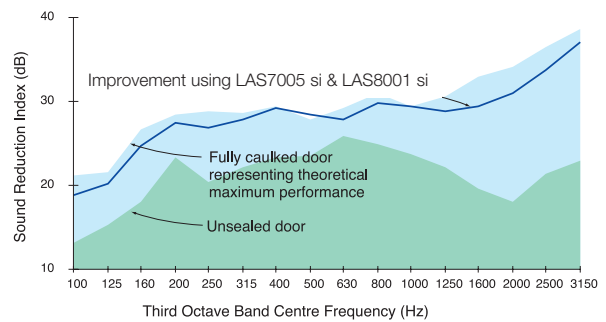

LAS7030 Perimeter Seal

Medium Duty



This seal with stainless steel cover meets smoke leakage performance requirements.

Location

Head and jambs of single swing doors.

Seal material

Foamed silicone rubber.

Standard lengths

1m, 2.1m and 3m. Other lengths to special order.

Fixing

Stainless steel fixing screws are supplied, fixing holes are pre-drilled and slotted to allow the seals to be adjusted and positioned accurately.

Finish

Grade 304 stainless steel with grey silicone rubber insert.

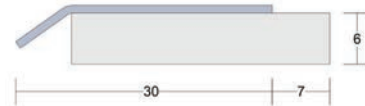

LAS7030

LAS7040 Perimeter Seal

Heavy Duty



This seal with stainless steel cover meets smoke leakage performance requirements.

Location

Head and jambs of single swing doors. Heavy duty hinged doors.

Seal material

Foamed silicone rubber.

Standard lengths

1m, 2.1m and 3m. Other lengths to special order.

Fixing

Stainless steel fixing screws are supplied, fixing holes are pre-drilled and slotted to allow the seals to be adjusted and positioned accurately.

Finish

Grade 304 stainless steel with grey silicone rubber insert.

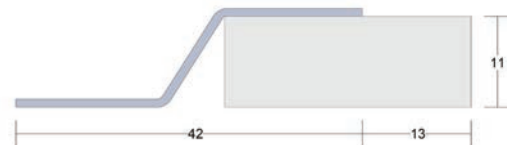

LAS7040



LAS8001 si Drop Seal

Medium Duty



An automatic drop seal with a high efficiency mechanism which lifts the seal clear of the floor as soon as the door is opened by a few millimetres; resulting in lower door operating forces. It requires no power connection.

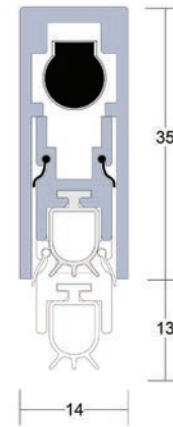

LAS8001 si

■ **Key benefits**

- Tested for acoustic performance with BS EN ISO 10140-2: 2010.
- Meets the smoke leakage performance requirements of BS 9999 and is used for sealing the threshold of door assemblies against leakage of ambient temperature smoke, as defined in BS 476: Part 31.1: 1983.
- Suitable for use on timber fire doors for up to 60 minutes under conditions of BS 476: Pt.20/22: 1987 and BS EN 1634-1: 2014.
- Tested for reliability, the seal completed 1,000,000 cycles without failure.

■ **Location**

Single swing doors. For use on both right and left handed doors.

■ **Use with**

Any perimeter seal. Any threshold plate.

■ **Min/max gap size**

1mm/13mm.

■ **Seal material**

Grey or black silicone rubber.

■ **Standard lengths**

335mm, 435mm, 535mm, 635mm, 735mm, 835mm, 935mm, 1035mm, 1135mm and 1235mm.
 Sizes above 1235mm are available on request.
 Note: Each length can be cut to the next size down.
 The 335mm can be cut back to 255mm.

■ **Fixing**

Fixing screws are supplied. This seal is mortised. Pre-drilled radiused end plates are supplied which also secure the product in place. (Square end plates available on request).

■ **Adjustment**

Self-levelling on uneven surfaces. Can be adjusted independently of the fixing screws.

■ **Finishes**

Silver anodised aluminium with silver end plates, and grey silicone rubber gasket. Silver anodised aluminium with bronze end plates, and black silicone rubber gasket.



LAS8001 si
(Shown with LAS4001)

■ **Acoustic Performance**

Weighted Sound Reduction Index (Rw): 37dB.

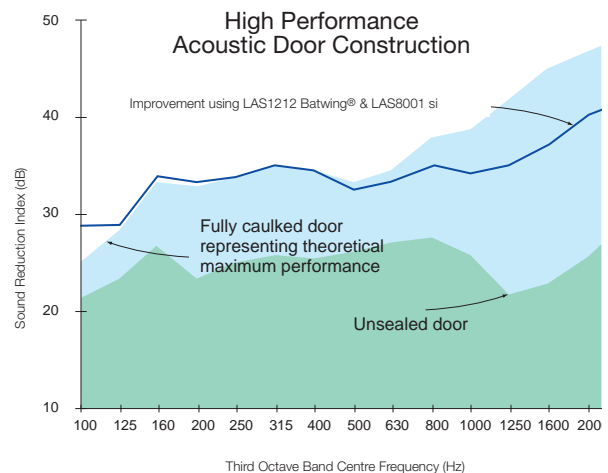

LAS8002 si Drop Seal

Medium Duty

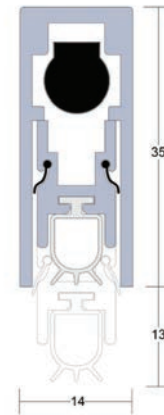

LAS8002 si

LAS8002 si is a face-fixed or semi-mortised drop seal with a high efficiency mechanism which lifts the seal clear of the floor as soon as the door is opened by a few millimetres; resulting in lower door operating forces. It requires no power connection. Surface mounted application suitable for upgrading existing doors.

Key benefits

Durable flexible elastomeric fin elements are incorporated with the housing to provide acoustic and smoke properties. Tested for acoustic performance with BS EN ISO 10140-2: 2010. Meets the smoke leakage performance requirements of BS 9999 and is used for sealing the threshold of door assemblies against leakage of ambient temperature smoke, as defined in BS 476: Part 31.1: 1983. Suitable for use on timber fire doors for up to 60 minutes under conditions of BS 476: Pt.20/22: 1987 and BS EN 1634-1: 2014 (when face-fixed). Tested for reliability, the seal completed 1,000,000 cycles without failure.

Location

Single swing doors.
For use on both right and left handed doors.

Use with

Any perimeter seal. Any threshold plate.

Min/max gap size

1mm/13mm.

Grey silicone rubber.

Standard lengths

335mm, 435mm, 535mm, 635mm, 735mm, 835mm, 935mm, 1035mm, 1135mm and 1235mm.

Note: each length can be cut to the next size down.
The 335mm can be cut back to 255mm.

Fixing

LAS8002 si is face-fixed or semi-mortised onto the door bottom. Screw fix using screws and ferrules provided. Fit end caps.

Adjustment

Self-levelling on uneven surfaces. Can be adjusted independently of the fixing screws.

Finishes

Silver anodised aluminium with grey end caps.
Grey silicone rubber. Bronze anodised aluminium with black end caps, and black silicone rubber gasket.



LAS8002 si
(Shown with LAS4001)

Acoustic Performance

Weighted Sound Reduction Index (Rw): 31dB.

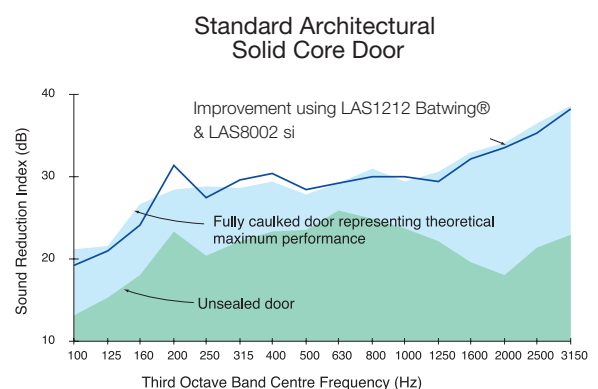

LAS8003 si Drop Seal

Medium Duty



LAS8003 si is a face-fixed or semi-mortised drop seal with a high efficiency mechanism which lifts the seal clear of the floor as soon as the door is opened by a few millimetres; resulting in lower door operating forces. It requires no power connection. Surface mounted application suitable for upgrading existing doors.

■ **Key benefits**

Durable flexible elastomeric fin elements are incorporated with the housing to provide acoustic and smoke properties. Tested for acoustic performance with BS EN ISO 10140-2: 2010.

Meets the smoke leakage performance requirements of BS 9999 and is used for sealing the threshold of door assemblies against leakage of ambient temperature smoke, as defined in BS 476: Part 31.1: 1983.

Suitable for use on timber fire doors for up to 60 minutes under conditions of BS 476: Pt.20/22: 1987 and BS EN 1634-1: 2014 (when face-fixed).

Tested for reliability, the seal completed 1,000,000 cycles without failure.

■ **Location**

Single swing doors.
For use on both right and left handed doors.

■ **Use with**

Any perimeter seal. Any threshold plate.

■ **Min/max gap size**

1mm/13mm.

■ **Seal material**

Grey silicone rubber.

■ **Standard lengths**

335mm, 435mm, 535mm, 635mm, 735mm, 835mm, 935mm, 1035mm, 1135mm and 1235mm.

Note: each length can be cut to the next size down. The 335mm can be cut back to 255mm.

■ **Fixing**

LAS8003 si is face-fixed or semi-mortised onto the door bottom. PVC cover strip should be removed, then drill aluminium and screw to door face, then replace PVC cover strip.

■ **Adjustment**

Self-levelling on uneven surfaces. Can be adjusted independently of the fixing screws.

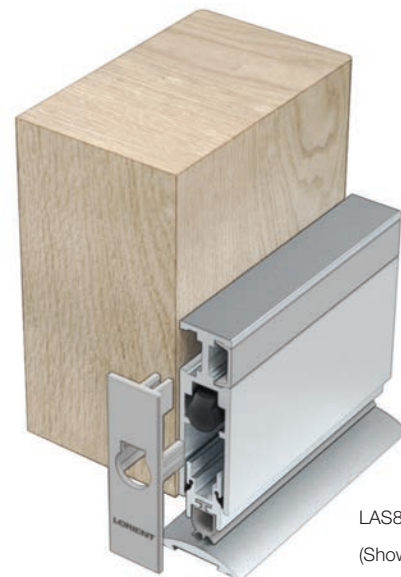
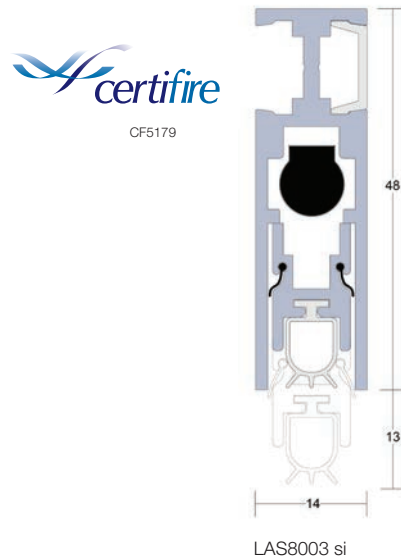

LAS8003 si
(Shown with LAS4001)

■ **Finishes**

Silver anodised aluminium with grey plastic end caps. Grey silicone rubber. Bronze anodised aluminium with black end caps, and black silicone rubber gasket.

■ **Acoustic Performance**

Weighted Sound Reduction Index (Rw): 31dB.

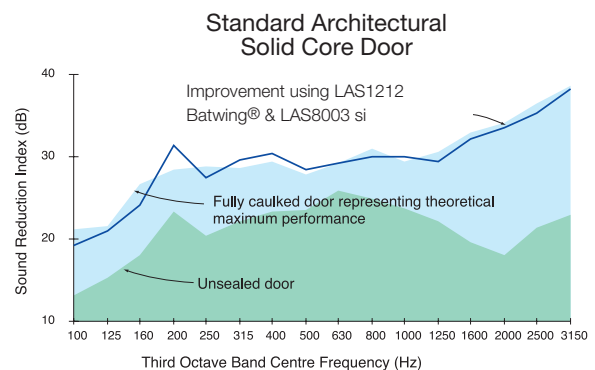

LAS8004 si Drop Seal

Heavy Duty



Mortised, automatic 'flat back' seal to suit installation to metal door rails. Spring-loaded mechanism lifts the seal clear of the floor as soon as the door is opened by a few millimetres.

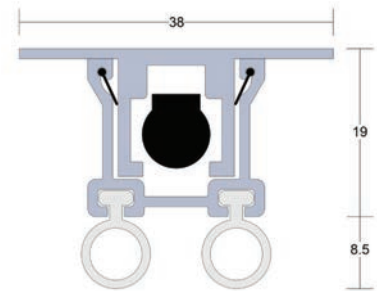

LAS8004 si

Key benefits

- Requires no power connection.
- Self-levelling on uneven floors, seal height can be adjusted independently of fixing screws.
- Tested for reliability, the seal completed 1,000,000 cycles without failure.

Location

- Single swing doors.
- Can be used on either right or left handed doors.

Use with

- Any threshold plate.

Min/max gap size

- 1mm/13mm.

Seal material

- Grey silicone gasket.

Standard lengths

- 635mm, 735mm, 835mm, 935mm, 1035mm, 1135mm and 1235mm.
- Note: Each length can be cut to the next size down
- The 635mm can be cut back to 535mm.
- Other lengths to special order.

Fixing

- Fixing screws are supplied, fixing holes are pre-drilled.

Adjustment

- Self-levelling on uneven surfaces.

Finishes

- Silver anodised aluminium.

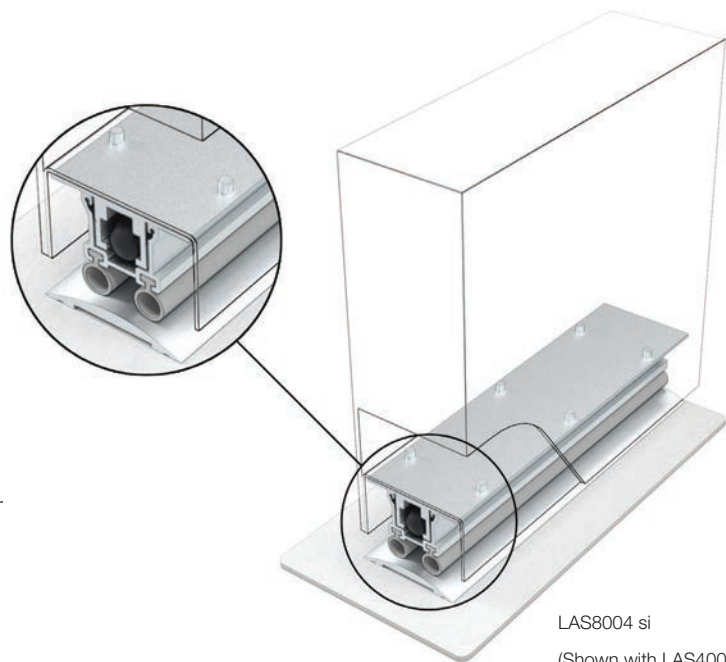
 LAS8004 si
 (Shown with LAS4001)

LAS8005 si Drop Seal

Medium Duty



CF5179

A slim-line, concealed drop seal featuring a high efficiency mechanism. The seal is lifted clear of the floor as soon as the door is opened by a few millimetres – resulting in exceptionally low door operating forces. It requires no power connection.

Key benefits

- Tested for acoustic performance with BS EN ISO 10140-2: 2010.
- Meets the smoke leakage performance requirements of BS 9999 when tested in accordance with BS 476: Pt.31.1: 1983.
- Tested for reliability, the seal completed 1,000,000 cycles without failure.
- Can be fitted to aluminium doors by door fabricators.

Location

- Single swing doors.
- For use on both right and left handed doors.

Use with

- Any perimeter seal.

Min/max gap size

- 1mm/13mm.

Seal material

- Grey silicone rubber.

Lengths

- 335mm, 435mm, 535mm, 635mm, 735mm, 835mm, 935mm, 1035mm, 1135mm and 1235mm.
- Note: Each length can be cut to the next size down.
- 335mm can be cut back to 255mm.

Fixing

- This seal is mortised, and screw fixed via the flanges.
- Fixing screws are supplied; fixing holes are pre-drilled and countersunk.

Adjustment

- Self-levelling on uneven surfaces. Seal height can be adjusted independently of the fixing screws.

Finishes

- Silver anodised aluminium, with grey or black plastic end caps. Grey or black silicone rubber.

Acoustic Performance

- Weighted Sound Reduction Index (Rw): 31dB.

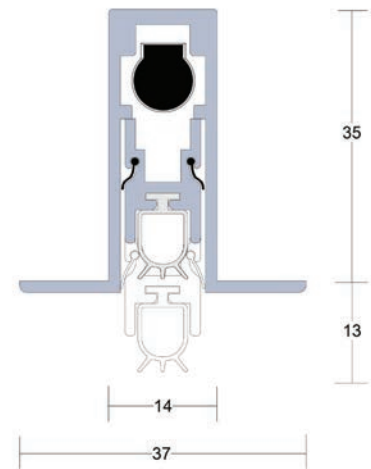

LAS8005 si



LAS8005 si

(Shown with LAS4001)

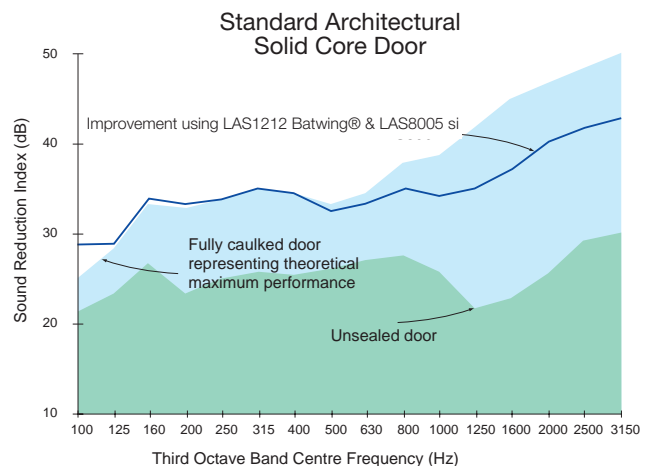

LAS8006 si Drop Seal

Heavy Duty



An automatic drop seal which is spring-loaded to lift clear of the floor as soon as the door is opened by a few millimetres. It requires no power connection. It is face fixed or can be semi-mortised and end caps are supplied.

Key benefits

Tested for acoustic performance with BS EN ISO 10140-2: 2010. It also meets the smoke leakage performance requirements of BS 9999 when tested in accordance with BS 476 Pt 31.1: 1983. Suitable for use on timber fire doors for up to 60 minutes under conditions of BS 476: Pt.20/22: 1987 and BS EN 1634-1: 2014 (when face-fixed). Tested for reliability, the seal completed 1,000,000 cycles without failure.

Location

Single swing doors.
For use on both right and left handed doors.

Use with

Any perimeter seal. Any threshold plate.

Min/max gap size

1mm/15mm.

Seal material

Black or grey silicone rubber.

Standard lengths

335mm, 435mm, 535mm, 635mm, 735mm, 835mm, 935mm, 1035mm, 1135mm and 1235mm.
Note: Each length can be cut to the next size down. The 335mm can be cut back to 275mm.

Fixing

Fixing screws are supplied, holes should be drilled at time of fixing.

Adjustment

Self-levelling on uneven surfaces – can be adjusted independently of the fixing screws.

Finish

Silver anodised aluminium with grey silicone rubber gasket, grey end caps.
Bronze anodised aluminium with black silicone rubber gasket, black end caps.

Acoustic performance

Weighted Sound Reduction Index (Rw): 36dB.

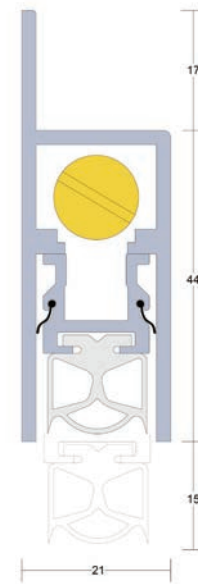

LAS8006 si

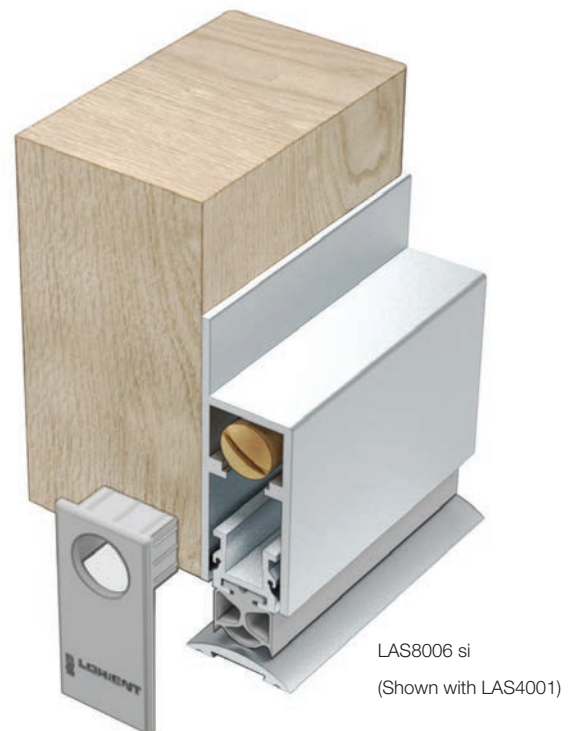
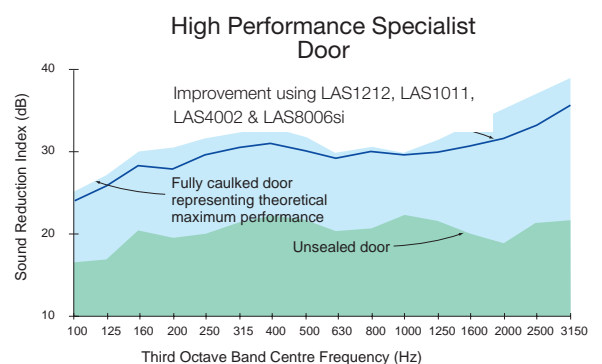
 LAS8006 si
(Shown with LAS4001)

LAS8007 si Drop Seal

Heavy Duty



A heavy duty automatic drop seal which is spring-loaded to lift clear of the floor as soon as the door is opened by a few millimetres. Plastic end caps are supplied. This is a fully mortised version of LAS8006 si.

Key benefits

It requires no power connection.

Tested for acoustic performance with BS EN ISO 10140-2: 2010.

It also meets the smoke leakage performance requirements of BS 9999 when tested in accordance with BS 476 Pt 31.1: 1983.

Tested for reliability, the seal completed 1,000,000 cycles without failure.

Location

Single swing doors.

For use on both right and left handed doors.

Use with

Any threshold plate.

Min/max gap size

1mm/15mm.

Seal material

Black or grey silicone rubber.

Standard lengths

335mm, 435mm, 535mm, 635mm, 735mm, 835mm, 935mm, 1035mm, 1135mm and 1235mm.

Note: Each length can be cut to the next size down.

The 335mm can be cut back to 275mm.

Fixing

Fixing screws are supplied, fixing holes are pre-drilled through the flanges.

Adjustment

Self-levelling on uneven surfaces - can be adjusted independently of the fixing screws.

Finishes

Silver anodised aluminium, grey silicone rubber gasket, grey end caps.

Silver anodised aluminium, black silicone rubber gasket, black end caps.

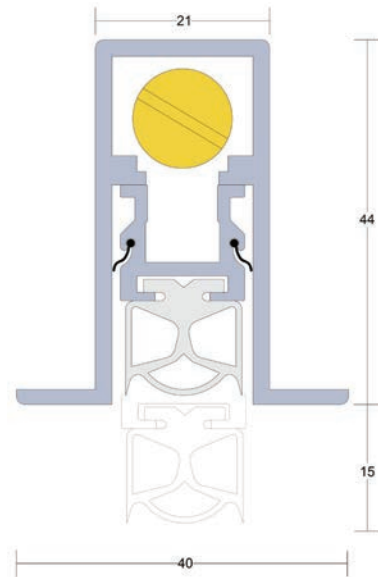

LAS8007 si



LAS8007 si

(Shown with LAS4001)

LAS8008 si Drop Seal

Medium Duty



LAS8008 si is a face-fixed drop seal with a high efficiency mechanism which lifts the seal clear of the floor as soon as the door is opened by a few millimetres; resulting in lower door operating forces. Its curved cover plate provides enhanced aesthetics: surface mounted only.

Key benefits

It requires no power connection.

Surface mounted application suitable for upgrading existing doors. Durable flexible elastomeric fin elements are incorporated with the housing to provide acoustic and smoke properties.

Tested for acoustic performance with BS EN ISO 10140-2: 2010.

It also meets the smoke leakage performance requirements of BS 9999 and is used for sealing the threshold of door assemblies against leakage of ambient temperature smoke, as defined in BS 476: Part 31.1: 1983.

Suitable for fire doors up to 60 minutes under conditions of BS 476: Pt.20/22: 1987 and BS EN 1634-1: 2014.

Tested for reliability, the seal completed 1,000,000 cycles without failure.

Location

Single swing doors. For use on both right and left handed doors.

Use with

Any perimeter seal. Any threshold plate.

Min/max gap size

1mm/13mm

Seal material

Grey silicone rubber.

Standard lengths

335mm, 435mm, 535mm, 635mm, 735mm, 835mm, 935mm, 1035mm, 1135mm and 1235mm.

Note: each length can be cut to the next size down.

The 335mm can be cut back to 255mm.

Fixing

Fixing screws are supplied, holes should be drilled at time of fixing. LAS8008 si is face-fixed only.

Adjustment

Self-levelling on uneven surfaces. Can be adjusted independently of the fixing screws.

Finishes

Silver anodised aluminium with grey plastic end caps. Grey silicone rubber. Silver anodised aluminium with black end caps. Black silicone rubber. Special colours can be supplied using a powder coated finish for additional aesthetics.

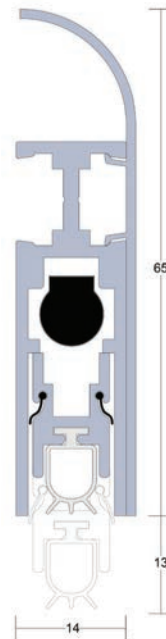

LAS8008

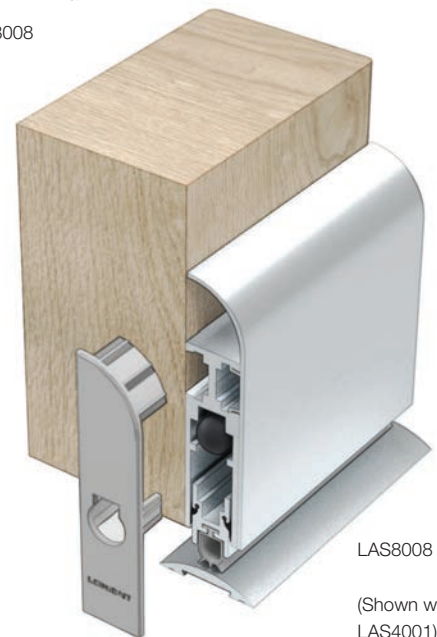

LAS8008 si

(Shown with LAS4001)

Acoustic Performance

Weighted Sound Reduction Index (Rw): 31dB.

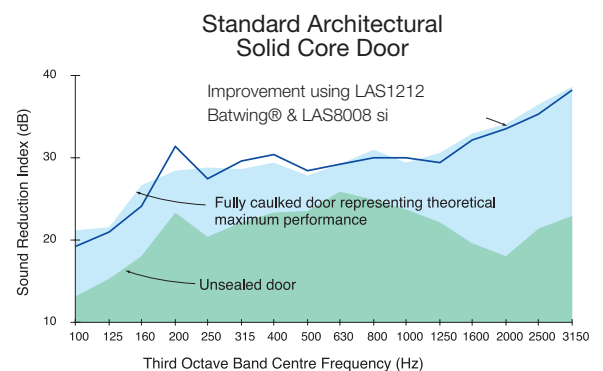

LAS8009 si Drop Seal

Heavy Duty



A heavy duty automatic drop seal which is spring-loaded to lift clear of the floor as soon as the door is opened by a few millimetres. Plastic end caps are supplied.

Key benefits

It requires no power connection.

It is face-fixed and its aluminium cover plate conceals fixing screws and presents an exceptionally smooth external aspect.

Tested for acoustic performance with BS EN ISO 10140-2: 2010.

Meets the smoke leakage performance requirements of BS 9999 when tested in accordance with BS 476 Pt 31.1: 1983.

Suitable for use on timber fire doors for up to 60 minutes under conditions of BS 476: Pt.20/22: 1987 and BS EN 1634-1: 2014.

Tested for reliability, the seal completed 1,000,000 cycles without failure.

Location

Single swing doors.

For use on both right and left handed doors.

Use with

Any perimeter seal.

Min/max gap size

1mm/15mm.

Seal material

Black or grey silicone rubber.

Standard lengths

335mm, 435mm, 535mm, 635mm, 735mm, 835mm, 935mm, 1035mm, 1135mm and 1235mm.

Each length can be cut to the next size down.

The 335mm can be cut back to 275mm.

Fixing

Fixing screws are supplied, holes should be drilled at time of fixing.

Adjustment

Self-levelling on uneven surfaces – can be adjusted independently of the fixing screws.

Finishes

Silver anodised aluminium cover plate, grey silicone rubber gasket, grey end caps.

Bronze anodised aluminium cover plate, black silicone rubber gasket, black end caps.

Special colours can be supplied using a powder coated finish for additional aesthetics.

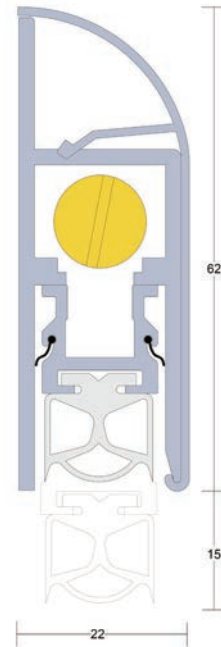

LAS8009 si

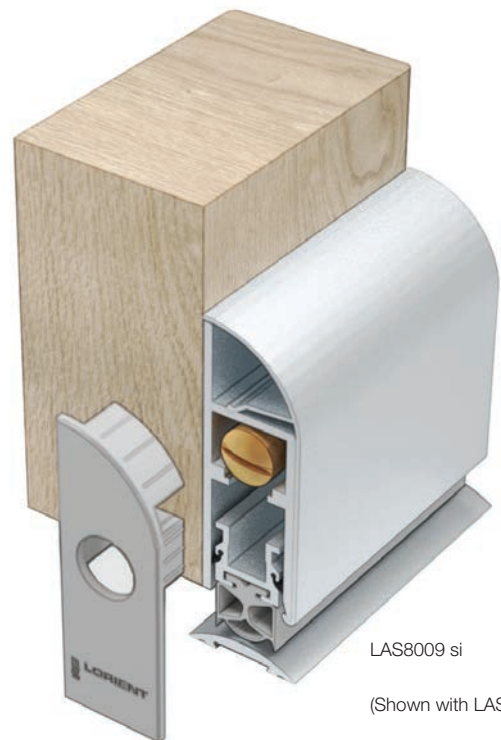

LAS8009 si

(Shown with LAS4001)

LAS8040 Drop Seal

Medium Duty



A drop seal designed to lift clear of the floor as soon as the door is opened by a few millimetres. It requires no power connection.

Key benefits

The unique double activated mechanism has an adjustable brass striker button at the hinge side and a nylon striker at the latch side. The mechanism also contains additional internal seals and a double compression facility to provide exceptional acoustic performance with minimal opening and closing resistance. Tested for acoustic performance with BS EN ISO 10140-2: 2010.

Location

Single leaf, single swing doors.
For use on both right and left handed doors.

Use with

Any perimeter seal.
Any threshold plate.

Min/max gap size

3mm/14mm.

Seal material

Flexible thermoplastic elastomer gasket and internal fins.

Standard lengths

335mm, 435mm, 535mm, 635mm, 735mm, 835mm, 935mm, 1035mm and 1135mm.

Note: each size cuts back by 70mm.

Fixing

Appropriate fixing screws are supplied, fixing holes are pre-drilled. Striker plates, which are located in the door jambs are supplied. This seal must be mortised.

Adjustment

Self-levelling on uneven surfaces - can be adjusted independently of fixing screws.

Finishes

Silver aluminium with black flexible insert.

Acoustic performance

Weighted Sound Reduction Index (Rw): 32dB.

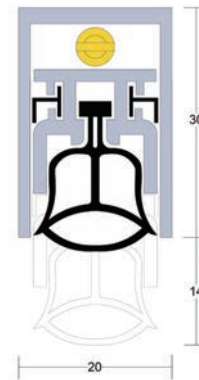

LAS8040



LAS8040

(Shown with LAS4001)

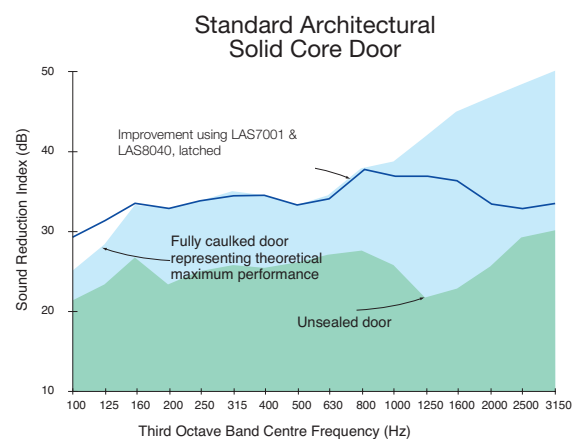

LAS8060 Drop Seal

Medium Duty



A stainless steel medium duty automatic drop seal which is spring-loaded to lift clear of the floor as soon as the door is opened by a few millimetres. It requires no power connection. The internal mechanism is extremely light to operate with minimal opening and closing resistance.

■ **Key benefit**

Meets the smoke leakage performance requirements of BS 9999 when tested in accordance with BS 476: Pt.31.1: 1983.

■ **Location**

Single swing doors.
For use on both right and left handed doors.

■ **Use with**

Any perimeter seal.
Any threshold plate.

■ **Min/max gap size**

3mm/13mm.

■ **Seal material**

Thermoplastic elastomer.

■ **Lengths**

725mm, 825mm, 925mm and 1025mm.
Note: each length can be reduced for an exact fit by up to 110mm.

■ **Fixing**

Fixing screws are supplied, fixing holes are pre-drilled. Striker button, which locates in the door jamb, is supplied. End plates not supplied.

■ **Adjustment**

Self-levelling on uneven surfaces. Adjustment can be carried out independently of the fixing screws.

■ **Finish**

Grade 304 stainless steel with grey thermoplastic elastomer gasket.

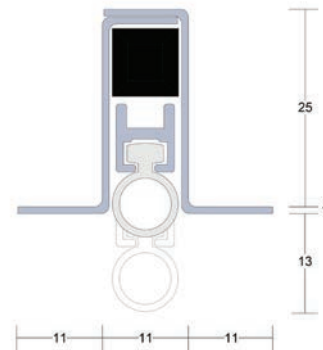

LAS8060

 LAS8060
(Shown with LAS4001)

LAS8070 Drop Seal

Heavy Duty



A stainless steel heavy duty automatic drop seal which is spring-loaded to lift clear of the floor as soon as the door is opened by a few millimetres. It requires no power connection. Impervious to most chemicals, solvents, cleaning fluids and disinfectants.

Key benefits

Meets the smoke leakage performance requirements of BS 9999 when tested in accordance with BS 476: Pt.31.1: 1983.

Suitable for fire doors up to 60 minutes under conditions of BS 476: Pt.20/22: 1987 and BS EN 1634-1: 2014.

Location

Single swing doors.
For use on both right and left handed doors.

Use with

Any perimeter seal.
Any threshold plate.

Min/max gap size

1mm/25mm.

Seal material

Foamed silicone rubber.

Standard lengths

610mm, 710mm, 815mm, 915mm, 1015mm, 1120mm and 1220mm.

Note: 610mm and 710mm length can be cut back by 80mm. Other lengths can be cut back by 100mm.

Fixing

Fixing screws are supplied, fixing holes are pre-drilled. Striker button, which locates in the door stop, is supplied. End plates are supplied.

Adjustment

Self-levelling on uneven surfaces. Adjustment can be carried out independently of fixing screws.

Finish

Grade 304 stainless steel with grey silicone rubber insert.

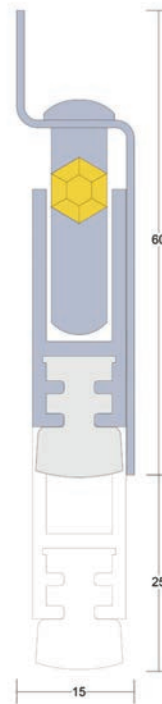

LAS8070

 LAS8070
(Shown with LAS4001)

LAS9001 Drip Seal

An overhead drip guard designed to channel rain water away from exposed doors, particularly those which open outward.

Key benefits

- Aesthetic anodised aluminium finish.
- Easy to fit.
- Concealed fixings.

Location

- Single and double leaf doors.
- Sliding doors.
- Roller shutter doors.
- Up and over doors.

Seal material

- Extruded aluminium.

Standard lengths

- 1m and 2.1m.

Fixing

- Steel screws are supplied (self-drilling and self-tapping screws for metal construction available on request). A PVC cover strip conceals the fixings. Allow an overlap of 50mm on each side of door opening.

Finishes

- Silver anodised aluminium.

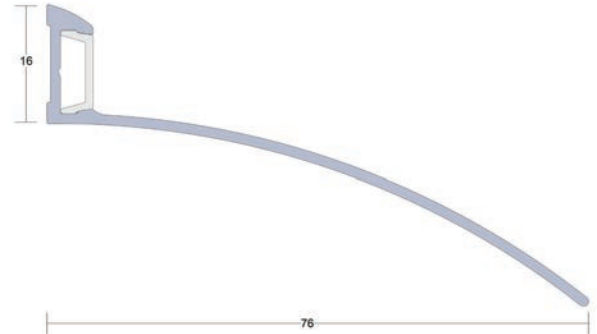

LAS9001



LAS9001

LAS9050 si and LAS9070 si Finger Guard Seals

Medium Duty



Trapping fingers in hinged doors can cause horrendous injuries. The risk is especially high in locations where young children are present. The finger guard seals provide a deterrent to finger trap injuries.

Key benefits

Provides protection on both sides of the door by using the LAS9050 si on the hinge knuckle side and the LAS9070 si on the hinge cavity side. LAS9070 si includes a unique, integral smoke and acoustic seal. It can be used in conjunction with the LAS7001 si acoustic seal around the remainder of the door perimeter for a comprehensive sealing and finger guard system. Tested over 500,000 opening and closing cycles without any sign of degradation.

Location

Jambes of hinged doors. LAS9070 si can be used on doors with an opening of 180°.

Use with

LAS7001 si perimeter seal and LAS8001 si drop seal (fully mortised).

Seal material

Silicone.

Standard lengths

2.1m. Other lengths to special order. Single doorset packs are available containing 1 x 2.1m LAS9050 si and 1 x 2.1m LAS9070 si.

Fixing

Self-tapping wood screws are supplied (self-drilling and self-tapping screws for metal construction available on request). Fixing holes are pre-drilled and slotted to allow the seals to be adjusted and positioned accurately. A PVC cover strip to conceal fixings is supplied.

Finishes

Silver anodised aluminium with grey cover strip and black gasket.
 Bronze anodised aluminium with black cover strip and black gasket.
 (Brown or cream gaskets are also available).



LAS9050 si

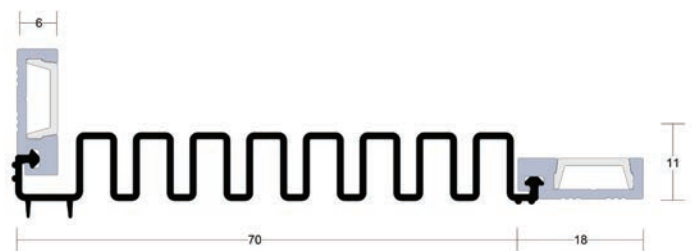

LAS9070 si



LAS9050 si

LAS9070 si

LAS9090 Safehinge™ Integrated Finger Protection for Doors

The LAS9090 Safehinge™ is a first-fit, integrated finger protection system utilising a specialist pivot set, which integrates a curved aluminium profile with the door.

The LAS Safehinge™ introduces new standards in durability, life cost savings and aesthetics. New evidence incorporates Lorient's high performance acoustic, smoke and fire seals - offering a simplified door seal configuration.

Key benefits

Innovative design. There is no opportunity for fingers to become trapped in the dangerous gap often to be found at the hanging stile.

Premium aesthetics. The aluminium profile has a natural anodised finish; and is fitted with a grey fire seal to blend discreetly with the profile.

Fire and smoke performance. Up to 30 minutes for single and double leaf doors; as well as 60 minutes for single leaf doors; tested in accordance with BS 476: Pt.22: 1987 and BS 476: Pt.31.1: 1983*.

Highly durable. Has achieved over 1.15 million cycles without any sign of failure. Has also achieved the Severe Duty grading - the highest possible grading to DD171:1987.

Location

Hanging stile of single and double leaf doors.

Finish

Aluminium profile - natural anodised finish.

Standard lengths

2.1m. Other lengths may be available upon request.

Fixing

Appropriate fixing screws are supplied, fixing holes are pre-drilled. On-site adjustability allows for building imperfections.

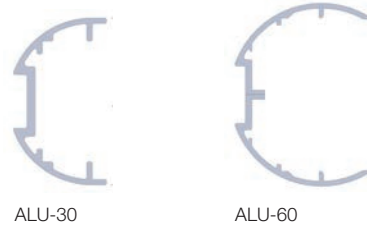
Extrusion profile

ALU-30

ALU-60

Kit codes

Code	Description
ALU30-100	ALU30 floor plate kit with 2.1m SAA extrusion (44mm), fire seal pack
ALU30-150	ALU30 L-bkt kit with 2.1m SAA extrusion (44mm), fire seal pack
ALU60-100	ALU60 floor plate kit with 2.1m SAA extrusion (54mm), fire seal pack
ALU60-150	ALU60 L-bkt kit with 2.1m SAA extrusion (54mm), fire seal pack

Variations of kit may be available upon request.

*Please note for 30 and 60 minutes fire and smoke performance, the LAS9090 Safehinge™ must be used with a specific Lorient door sealing system. Please contact Lorient's Technical Services team for further information on 01626 834252.



Fitting Instructions

Comprehensive fitting instructions are included with each consignment; and are also available to download from our website www.lorientuk.com

Maintenance

Periodic inspection and cleaning is recommended for all types of seals. The appearance and performance of seals will benefit from an annual wipe with a damp cloth. Seals should be checked for correct adjustment. Worn or damaged seals should be replaced immediately.

Compatibility

All Lorient Architectural Seals are compatible with the materials normally used in doors and door frames, including wood, steel, PVC, aluminium and glass.

Please Note: Recommendations as to methods, use of materials and construction details are based on the experience and knowledge of Lorient and are given in good faith as a general guide and a service to designers, contractors and manufacturers.

additional information

Accreditation

Lorient is quality assured under the disciplines of BS EN ISO 9001:2008.

Accreditation to this standard is a guarantee that we conduct our business to the complete satisfaction of our customers with regard to design solutions, manufacturing consistency and management procedures. In addition, this internationally recognised standard for quality management generates customer confidence and eliminates the risk of poor performance. Regular audits of our company procedures are undertaken by qualified BSI staff to ensure ongoing compliance with all aspects of the standard.



BS EN ISO 9001:2008
Certificate No. Q6104



BS EN ISO 14001:2004
Certificate No. EMS 541906

Lorient has attained BS EN ISO 14001:2004 accreditation for environmental management, making us the first seal manufacturer to have achieved this important award. This internationally recognised standard represents that we have demonstrated our commitment to responsible environmental behaviour, including prevention of pollution, control and reduction of waste, and ongoing monitoring and improvement of our environmental performance. Achieving ISO 14001 is just one part of our ongoing commitment to operate in a sustainable way.

Trade Associations

Lorient is proud to be a member of the following associations.



Intellectual Property

© 2014 Lorient Polyproducts Ltd – this brochure is protected by copyright and neither the drawings nor the text may be reproduced or transmitted in any form without prior consent from Lorient. Lorient products described in this brochure may be protected by patents and design registrations in Great Britain and other countries.

We are committed to continually enhancing and improving our product range. We reserve the right to change product specifications from time to time without prior notice. E&OE.

Continuing Professional Development Seminars

We offer three fully-accredited CPD seminars. Impartially presented by knowledgeable speakers, the seminars are structured to be technically informative, and give practical advice.



Performance Door Design: The Basics of Sound Reduction

Effective acoustic containment helps to improve the quality of the built environment, preserving privacy as well as excluding unwanted noise. With changing regulations, it's essential to be informed of the relevant requirements and the implications for door assemblies.

Our acoustic CPD seminar covers:

- the nature of sound, examining airborne transmission of sound;
- regulatory requirements and British Standards that relate to acoustic performance;
- test procedures and interpretation of test reports;
- effective design of door assemblies for acoustic performance, including door construction and the influence of sealing systems;
- design conflicts between acoustic performance, durability and ease of operation of the door;
- independent accreditation.

The Role and Performance of Fire and Smoke-Resisting Door Assemblies

The importance of fire and smoke resisting door assemblies is illustrated by the **388 annual deaths** in fire tragedies in the UK alone. Apart from the human toll, **property losses each year approach £2.52 billion**.

Our fire and smoke containment CPD seminar covers:

- hard facts concerning deaths, injuries and property damage caused by fire and smoke;
- regulatory requirements for fire and smoke resisting door assemblies;
- the nature and behaviour of smoke;
- effective design of door assemblies for smoke containment, including the threshold gap;
- design conflicts between fire containment, smoke containment, durability and ease of operation of the door;
- independent accreditation.

The Regulatory Reform (Fire Safety) Order 2005 and its implications for fire doors

The RRO consolidated 70 pieces of legislation; shifted responsibility for fire safety management; abolished the Fire Safety Certificate; established the Fire Risk Assessment and created major change in legal liability.

Our RRO CPD seminar covers:

- an overview of the RRO;
- product solutions;
- the dangers of fire and smoke;
- the importance of fire doors – including installation and maintenance.

Our CPD materials have been independently verified and certified by the RIBA as CPD approved. A certificate for 1 hour's CPD will be provided, which contributes to Continuing Professional Development requirements. If you're interested in booking either seminar, please contact our Marketing department or e-mail cpd@lorientuk.com.

We continue to lead the way in research and development. As a company we have 35 years' experience, so our experts are well equipped to listen, help and advise you on your acoustic, smoke and fire containment needs.

testing & technical services

Technical Support

We're happy to provide specialist advice on acoustic, smoke and fire protection for refurbishment and new build projects. If you need assistance, you can call our Technical Services team.

Alternatively, we can arrange a site visit to get a clearer idea of your needs and how we can help you. We also provide copies of test reports and samples where needed and can give guidance on how best to meet Building Regulations and Standards.

Customisation

If you have a particular requirement which isn't covered by the applications in this brochure, we may be able to supply an existing non-standard item, or even develop a customised solution for you.

Testing Services

Our Testing & Technical Services centre offers a variety of specialist testing services including a state-of-the-art Acoustic Transmission Suite for manufacturers and designers of assemblies including doorsets, windows, glazing systems, door hardware to name but a few.

Whether you're investigating new materials, or developing new or existing products, right through to durability testing and benchmarking performance – our team of experts will support you throughout the process. If you're looking to work in partnership on a longer-term project, we'd be pleased to discuss your requirements.

Call our Technical Services team on
+44 (0)1626 834252
www.lorientuk.com



Acoustic Transmission Suite

Our acoustic transmission suite is run by respected and experienced technical consultants, who will oversee the testing process from start to finish; and guide you through the maze of regulations. Working closely together, we'll design and implement a test programme to meet your specific requirements.

Our technicians have many years' experience building test specimens, and we also offer an installation service. Once the testing programme is complete, a number of options is available on top of an inclusive report, you could upgrade to a comprehensive report underwritten by an independent acoustic expert.

Indicative Furnace

Lorient's indicative furnace has proven popular for many years, providing customers with real insight into their own products' performance. Prior to full scale testing our customers can use the furnace for product development purposes – helping to save substantial testing costs.

Using our furnace, the fire resistance properties of building materials can be tested in accordance with BS 476 Pt. 20 (method of test for determination of the fire resistance of elements of construction) or EN 1363-1 (fire resistance test standard); or be client specific to suit a particular purpose.

The test specimen (which only represents the top of the door) is placed at the front of the furnace and exposed to standard fire conditions. The location and period of fire resistance is determined by the regulatory requirement which could be 30/60/90 or 120 minutes.

Other Testing Services

Alongside full-scale acoustic testing and indicative fire testing, we also offer a range of complementary services. These include:

- Smoke leakage;
- Air leakage;
- Mechanical cycling;
- Environmental chamber analysis;
- Site-based acoustic testing;
- Attendance at external fire tests;
- Consultancy services;
- **New:** Fire Door Inspection Services, carried out by fully qualified FDIS Certificated Inspectors - please ask for further information.

For further information about Lorient products please visit our website

www.lorientgroup.com

or follow us at:



@LorientUK



/company/lorient



UK and Europe

Tel: +44 (0) 1626 834252

Fax: +44 (0) 1626 833166

email: mktg@lorientuk.com

USA

Tel: +1 859 252 7441

Fax: +1 859 381 1241

email: info@lorientna.com

Australia

Tel: +61 (02) 99076221

email: sales@lorient.com.au

Hong Kong

Tel: +852 2505 0328

Fax: +852 2505 0332

email: sales@lorienthk.com

Singapore

Tel: +65 6270 1279

email: sales@lorientsea.com

Middle East

c/o Laidlaw Gulf LLC Dubai

Fax: +971 4885 7404

email: lorient@laidlaw.ae



Lorient Polyproducts Ltd
Endeavour House
Fairfax Road
Heathfield Ind Estate
Newton Abbot
Devon TQ12 6UD UK

