

Our comprehensive one stop range of architectural ironmongery
and access control products

T: 020 8531 9696 F: 020 8531 9678

E: sales@granthazelondon.co.uk

















W: www.granthazelondon.co.uk

Introduction

Welcome to our comprehensive one stop range which has been designed with maintenance and constructional contractors in mind. This collection is ideal for refurbishment and new builds, especially public utilities such as: Hospitals, NHS Projects, Nursing homes, Care Homes, Schools, Universities and all commercial aspects of ironmongery and access control specification.

Our range of products are fully certified in EU compliances to the highest level which cover all aspects of panic hardware, door closers, cylinder systems, door locks, hinges, fire protection and all access control related designs.

Index

	Stainless Steel Furniture and Hardware Accessories	P2-7
	Aluminium Furniture and Hardware Accessories	P8-9
	Nylon Coated Hardware and Accessories	P10
	Floor Springs	P10
	Overhead Door Closers/Automatic Door Operators	P11-13
	Concealed Door Closers	P14
	Panic Hardware	P15-16
	Universal Door Sets for UPVC, Aluminium, Composite & Wooden Doors	P17
	Digital Locks/Tubular Latches/Roller Catches	P18
	European Lock Cases	P19
	UK Lock Cases/NightLatches	P20
	Metal Door Locks & Accessories	P21-22
	Cylinder Ranges/Offset & Masterkeyed	P23
	Hinges	P24
	Fire Protection	P24-25
	Access Control Products	P26-29

Stainless Steel Hardware

The Stainless Steel Lever Range is manufactured from various grades of Stainless Steel materials dependent on customers preference and represents a modest range of Sprung Levers in either Round Bar or Solid Stainless Steel.

DSL101 Return to Door Lever

Ref. No.	Description
DSL101/U/304/SP	DSL101 "Return" lever s.s.s. 6mm sprung
DSL101/U/304/PSS	DSL101 "Return " lever p.s.s. 6mm sprung
DSL101/S/22/SP	DSL101 22mm "Return " lever s.s.s. 6mm sprung
DSL101/S/22/PSS	DSL101 22mm "Return " leverp.s.s. 6mm sprung

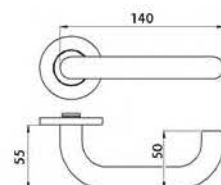

DSL103 Mitred Lever

Ref. No.	Description
DSL103 s.s.s. 6mm	DSL103 "Mitred" lever s.s.s. 6mm sprung
DSL103 p.s.s. 6mm	DSL103 "Mitred" lever p.s.s. 6mm sprung

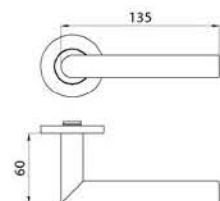

DSL104 Arched Lever

Ref. No.	Description
DSL104 s.s.s. 6mm	DSL104 "Arched" lever s.s.s. 6mm sprung
DSL104 p.s.s. 6mm	DSL104 "Arched" lever p.s.s. 6mm sprung

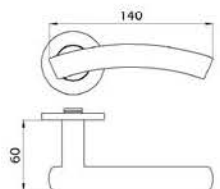

DSL106 Tee Lever

Ref. No.	Description
DSL106 s.s.s. 6mm	DSL106 "Tee" lever s.s.s. 6mm sprung
DSL106 p.s.s. 6mm	DSL106 "Tee" lever p.s.s. 6mm sprung

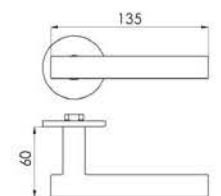

DSL110 'S' Lever

Ref. No.	Description
DSL110 s.s.s. 6mm	DSL110 "S" lever s.s.s. 6mm sprung
DSL110 p.s.s. 6mm	DSL110 "S" lever p.s.s. 6mm sprung

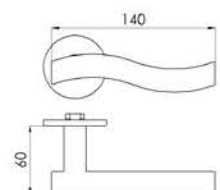

DSL111
'Curved Crank' Lever

Ref. No.	Description
DSL111 s.s.s. 6mm	DSL111 "Curved Crank" lever s.s.s. 6mm sprung
DSL111 p.s.s. 6mm	DSL111 "Curved Crank" lever p.s.s. 6mm sprung

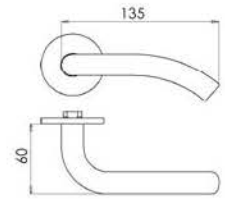

DSL122
'Curved Mitred' Lever

Ref. No.	Description
DSL122 s.s.s. 6mm	DSL122 "Curved Mitred" lever s.s.s. 6mm sprung
DSL122 p.s.s. 6mm	DSL122 "Curved Mitred" lever p.s.s. 6mm sprung

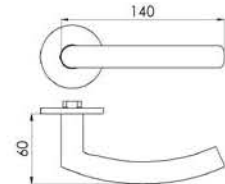

DSL124
'Curved Tee' Lever

Ref. No.	Description
DSL124 s.s.s. 6mm	DSL124 "Curved Tee" lever s.s.s. 6mm sprung
DSL124 p.s.s. 6mm	DSL124 "Curved Tee" lever p.s.s. 6mm sprung

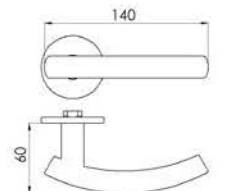

DSL302
'Propeller' Lever

Ref. No.	Description
DSL302 s.s.s. 6mm	DSL302 "Propeller" lever s.s.s. 6mm sprung

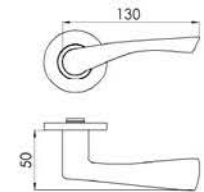

DSL306
'Goldwing' Lever

Ref. No.	Description
DSL306 s.s.s. 6mm	DSL306 "Goldwing" lever s.s.s. 6mm sprung

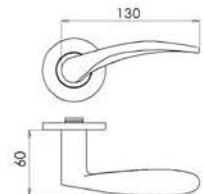

DSL320
'Zola' Lever

Ref. No.	Description
DSL320 s.s.s. 6mm	DSL320 "Zola" lever s.s.s. 6mm sprung

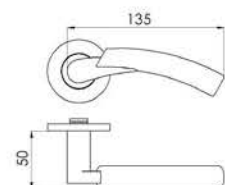

Stainless Steel Levers on Plate

Stainless Steel Levers on Plate will be available for both UK and European Lock Cases and represents the widest range possible to suit the UK Commercial and Public Utility Sectors.



22mm Lever Version Available

Oblong Face Fix Plate (19mm Lever)

Satin

Ref. No.	Description
DS400/21/SS	Latch
DS400/22/SS	Lock
DS400/23/SS	Euro Profile
DS400/24/SS	Oval Profile
DS400/25/SS	Bathroom

Polished

Ref. No.	Description
DS400/21/PSS	Latch
DS400/22/PSS	Lock
DS400/23/PSS	Euro Profile
DS400/24/PSS	Oval Profile
DS400/25/PSS	Bathroom

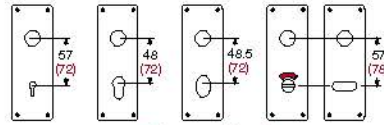

(European Sizes)

EUROPEAN SIZES ALSO AVAILABLE

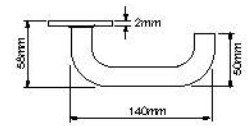
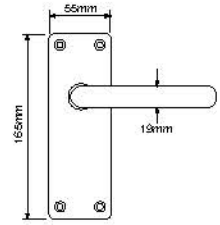

22mm Lever Version Available

Square Face Fix Plate (19mm Lever)

Satin

Ref. No.	Description
DS400/16/SS	Latch
DS400/17/SS	Lock
DS400/18/SS	Euro Profile
DS400/19/SS	Oval Profile
DS400/20/SS	Bathroom

Polished

Ref. No.	Description
DS400/16/PSS	Latch
DS400/17/PSS	Lock
DS400/18/PSS	Euro Profile
DS400/19/PSS	Oval Profile
DS400/20/PSS	Bathroom

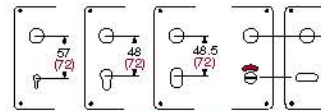

(European Sizes)

EUROPEAN SIZES ALSO AVAILABLE

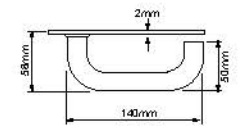
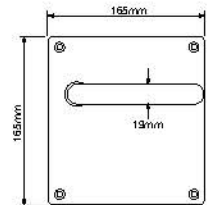

22mm Lever Version Available

Radiused Concealed Plate (19mm Lever)

Satin

Ref. No.	Description
DS400/31/SS	Latch
DS400/32/SS	Lock
DS400/33/SS	Euro Profile
DS400/34/SS	Oval Profile
DS400/35/SS	Bathroom

Polished

Ref. No.	Description
DS400/31/PSS	Latch
DS400/32/PSS	Lock
DS400/33/PSS	Euro Profile
DS400/34/PSS	Oval Profile
DS400/35/PSS	Bathroom

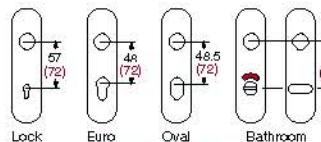

(European Sizes)

EUROPEAN SIZES ALSO AVAILABLE

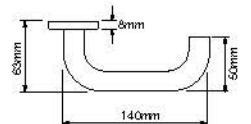
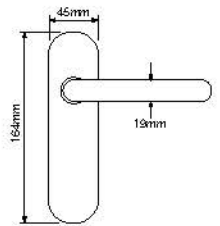

22mm Lever Version Available

Oblong Concealed Plate (19mm Lever)

Satin

Ref. No.	Description
DS400/11/SS	Latch
DS400/12/SS	Lock
DS400/13/SS	Euro Profile
DS400/14/SS	Oval Profile
DS400/15/SS	Bathroom

Polished

Ref. No.	Description
DS400/11/PSS	Latch
DS400/12/PSS	Lock
DS400/13/PSS	Euro Profile
DS400/14/PSS	Oval Profile
DS400/15/PSS	Bathroom

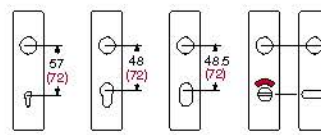

(European Sizes)

EUROPEAN SIZES ALSO AVAILABLE

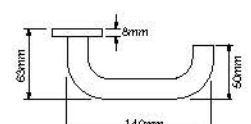
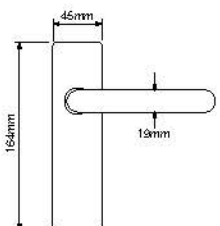

Stainless Steel Hardware

DSPH402

'D' Pull Handles (Bolt Fix)

Ref. No.	Description
DSPH402/BT/150/SP	150 x 19mm Bolt Fix s.s.s.
DSPH402/BT/225/SP	225 x 19mm Bolt Fix s.s.s.
DSPH402/BT/300/SP	300 x 19mm Bolt Fix s.s.s.
DSPH402/BT/425/SP	425 x 19mm Bolt Fix s.s.s.
DSPH402/BT/600/SP	600 x 19mm Bolt Fix s.s.s.
DSPH402/BT/225/22/SP	225 x 22mm Bolt Fix s.s.s.
DSPH402/BT/300/22/SP	300 x 22mm Bolt Fix s.s.s.
DSPH402/BT/425/22/SP	425 x 22mm Bolt Fix s.s.s.
DSPH402/BT/600/22/SP	600 x 22mm Bolt Fix s.s.s.



DSPH404

'Tee' Pull Handles (Bolt Fix)

Ref. No.	Description
DSPH404/BT/300/SP	300 x 200 x 19mm Bolt Fix s.s.s.
DSPH404/BT/525/SP	525 x 425 x 19mm Bolt Fix s.s.s.
DSPH404/BT/1000/SP	1000 x 850 x 25mm Bolt Fix s.s.s.
DSPH404/BT/1500/SP	1500 x 1350 x 32mm Bolt Fix s.s.s.
DSPH404/BT/1800/SP	1800 x 1650 x 32mm Bolt Fix s.s.s.



'D' Pull Handles (Back to Back)

Ref. No.	Description
DSPH402/BB/150/SP	150 x 19mm Back to Back s.s.s.
DSPH402/BB/225/SP	225 x 19mm Back to Back s.s.s.
DSPH402/BB/300/SP	300 x 19mm Back to Back s.s.s.
DSPH402/BB/425/SP	425 x 19mm Back to Back s.s.s.
DSPH402/BB/600/SP	600 x 19mm Back to Back s.s.s.
DSPH402/BB/225/22/SP	225 x 22mm Back to Back s.s.s.
DSPH402/BB/300/22/SP	300 x 22mm Back to Back s.s.s.
DSPH402/BB/425/22/SP	425 x 22mm Back to Back s.s.s.
DSPH402/BB/600/22/SP	600 x 22mm Back to Back s.s.s.

'Tee' Pull Handles (Back to Back)

Ref. No.	Description
DSPH404/BB/1000/SP	1000 x 850 x 25mm Back to Back s.s.s.
DSPH404/BB/1500/SP	1500 x 1350 x 32mm Back to Back s.s.s.
DSPH404/BB/1800/SP	1800 x 1650 x 32mm Back to Back s.s.s.

OTHER SIZES AVAILABLE ON REQUEST

DSPH430

'Cranked' Pull Handles (Bolt Fix)

Ref. No.	Description
DSPH430/300/19/SP	Cranked Bolt Fix s.s.s.
DSPH430/425/19/SP	Cranked Bolt Fix s.s.s.
DSPH430/600/19/SP	Cranked Bolt Fix s.s.s.
DSPH430/425/22/SP	Cranked Bolt Fix s.s.s.
DSPH430/600/22/SP	Cranked Bolt Fix s.s.s.

DSPH403

'Mitred' Pull Handles (Bolt Fix)

Ref. No.	Description
DSPH403/BT/300/19/SP	300 x 19mm Bolt Fix s.s.s.
DSPH403/BT/425/19/SP	425 x 19mm Bolt Fix s.s.s.

DSPH405

'Arched' Pull Handles (Bolt Fix)

Ref. No.	Description
DSPH405/BT/300/SP	300 x 200 x 19mm Bolt Fix s.s.s.
DSPH405/BT/525/SP	525 x 425 x 19mm Bolt Fix s.s.s.

DSPH408

'Oval Mitred' Pull Handle (Bolt Fix)

Ref. No.	Description
DSPH408/BB/Oval	300mm cc



OTHER SIZES AVAILABLE ON REQUEST

Stainless Steel Hardware

DSPH409

'Curved Tee' Pull Handle (Bolt Fix)

Ref. No.	Description
DSPH409/BB/Curved	Curved Tee Pull Handle



Curved Tee



Wave

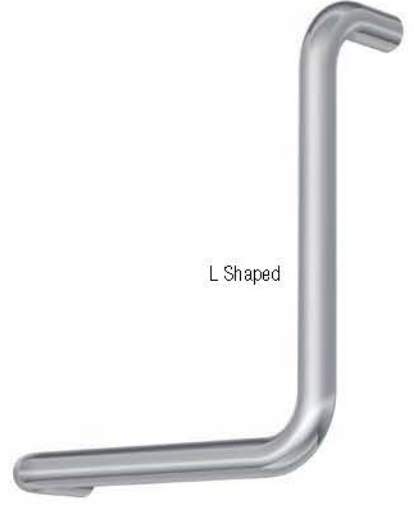

L Shaped

DSPH410

'Wave' Pull Handle (Bolt Fix)

Ref. No.	Description
DSPH410/BB/Wave	Wave Pull Handle

DSPH411

'L Shaped' Pull Handle (Bolt Fix)

Ref. No.	Description
DSPH411/BB/"L" Shape	L Shaped Pull Handle

PRICE ON APPLICATION

DSPH418

'Semi Circle' Pull Handle (Bolt Fix)

Ref. No.	Description
DSPH418/BB/Semi	Semi Circle Pull Handle 300 x 25mm



Semi Circle

DSPH419

'Mitre Semi Circle' Pull Handle (Bolt Fix)

Ref. No.	Description
DSPH419/BB/Mitre Semi	Mitre Semi Circle Pull Handle 300 x 32mm



S Pull

DSPH426

'S Pull' Pull Handle (Bolt Fix)

Ref. No.	Description
DSPH426/BB/"S" Pull	S Pull Handle 400 x 300 x 19mm

DSPH428

'Square Box' Pull Handle (Bolt Fix)

Ref. No.	Description
DSPH428/BB/"SQ" Box	Square Box Pull Handle 25mm



Square Box

PRICE ON APPLICATION

Stainless Steel Hardware

Accessories

Ref. No.	Description
DSEE/SP/5	5mm x 54mm Dia Euro Escutcheon s.s.s.
DSEKSP/5	5mm x 54mm Dia Key Escutcheon s.s.s.
DSEO5P/5	5mm x 54mm Dia Oval Escutcheon s.s.s.
DSEBSP/5	5mm x 54mm Dia Blank Escutcheon s.s.s.
DSTISP/5	5mm x 54mm Dia Thumbturn & Ind set s.s.s.
DSLATISP/5	5mm x 54mm Dia Less Able Thumbturn & Ind set s.s.s.
DSCPE	90mm x 42mm Euro Rim Pull
DSCPO	90mm x 42mm Oval Rim Pull
DSCPK	90mm x 42mm Key Rim Pull
DSCPR	90mm x 42mm Round Rim Pull
DSCPB	90mm x 42mm Blank Rim Pull
DSDS1SP	45mm Oval Door stop s.s.s.
DSDS2SP	30mm Round Door Stop s.s.s.
DSDS3SP	80mm Projection Door Stop s.s.s.
DSMRS2SP	76mm Male disc s.s.s.
DSFRM2SP	76mm Female disc s.s.s.
DSURS2SP	76mm Male & Female disc s.s.s.
DSLASSP	76mm Less Able disc s.s.s.
DSFDKS/SP	76mm "Fire Door Keep Shut" disc s.s.s.
DSFDKL/SP	76mm "Fire Door Keep Locked" disc s.s.s.
DSP1/SP	76mm "Pull" Disc s.s.s.
DSP2/SP	76mm "Push" Disc s.s.s.
DSFB200SP	200mm x 25mm Flush Bolt s.s.s.
DSECS/SP	Easy Clean Socket to suit Flush Bolt s.s.s.
DSCDK	67mm Door Knob
DSP3	350mm X 75mm Push Hand Plate
DSP4	350mm X 75mm Blank Hand Plate
DSHC1SP	Buffered Hat & Coat Hook s.s.s.
DSHC2SP	Hat & Coat Hook s.s.s.
DSHC3SP	Single Coat Hook s.s.s.
DSOR	5mm x 54mm on Rose set for 19mm Pull Handles s.s.s.
DOORSP	Round Rose 5mm to suit 54mm Dia Pull Handles
DSMBL	Mortice Bathroom Lock 3"
DSBUDL	Mortice Budget Lock Rim Type
DSHCHW4	Hat & Coat Hook Rail 4 - White with 4 Hooks
DSHCHW5	Hat & Coat Hook Rail 5 - White with 5 Hooks
DSHCHP4	Hat & Coat Hook Rail 4 - Pine with 4 Hooks
DSHCHP5	Hat & Coat Hook Rail 5 - Pine with 5 Hooks

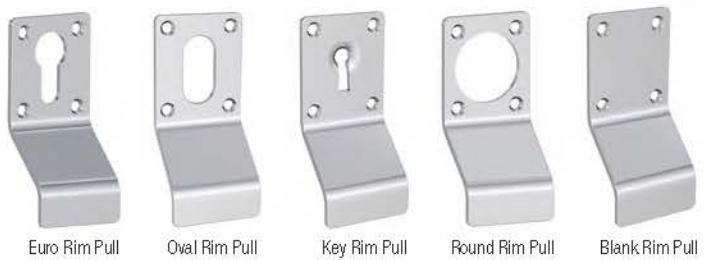

NEW
Please note that it is a NHBC Requirement to supply Coat & Hat Rails for new Build 3,4 & 5 Bedroom Houses

Aluminium Hardware

The Aluminium Range of furniture is a quality specification which is designed to compliment the Stainless Steel Range and is ideally suited for Public Utilities such as Schools, Hospitals, Care Homes, etc.

DSL101 Return to Door Lever

Ref. No.	Description
DSL101/U/19/PA	DSL101 "Return" lever P.A.A 5mm unsprung
DSL101/S/19/PA	DSL101 "Return" lever P.A.A 10mm sprung
DSL101/U/22/PA	DSL101 "Return" lever P.A.A 5mm unsprung
DSL101/S/22/PA	DSL101 "Return" lever P.A.A 10mm sprung

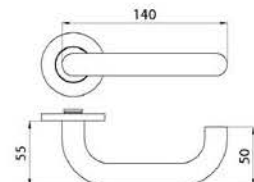

DSPH402 'D' Pull Handles (Bolt Fix)

Ref. No.	Description
DSPH402/BT/225/19/PA	225 x 19mm Bolt Fix P.A.A
DSPH402/BT/300/19/PA	300 x 19mm Bolt Fix P.A.A
DSPH402/BT/450/19/PA	450 x 19mm Bolt Fix P.A.A
DSPH402/BT/600/19/PA	600 x 19mm Bolt Fix P.A.A
DSPH402/BT/225/22/PA	225 x 22mm Bolt Fix P.A.A
DSPH402/BT/300/22/PA	300 x 22mm Bolt Fix P.A.A
DSPH402/BT/450/22/PA	450 x 22mm Bolt Fix P.A.A
DSPH402/BT/600/22/PA	600 x 22mm Bolt Fix P.A.A

'D' Pull Handles (Back to Back)

DSPH402/BB/225/19/PA	225 x 19mm Back to Back P.A.A
DSPH402/BB/300/19/PA	300 x 19mm Back to Back P.A.A
DSPH402/BB/450/19/PA	450 x 19mm Back to Back P.A.A
DSPH402/BB/600/19/PA	600 x 19mm Back to Back P.A.A
DSPH402/BB/225/22/PA	225 x 22mm Back to Back P.A.A
DSPH402/BB/300/22/PA	300 x 22mm Back to Back P.A.A
DSPH402/BB/450/22/PA	450 x 22mm Back to Back P.A.A
DSPH402/BB/600/22/PA	600 x 22mm Back to Back P.A.A

'Tee' Pull Handles (Bolt Fix)

Ref. No.	Description
DSPH404/BT/1000/PA	1000 x 850 x 25mm Dia Bolt Fix P.A.A
DSPH404/BT/1350/PA	1350 x 850 x 32mm Dia Bolt Fix P.A.A
DSPH404/BT/1650/PA	1650 x 850 x 32mm Dia Bolt Fix P.A.A

'Tee' Pull Handles (Back to Back)

DSPH404/BB/1000/PA	1000 x 850 x 25mm
--------------------	-------------------

'Cranked' Pull Handles (Bolt Fix)

Ref. No.	Description
DSPH430/BT/300/19/PA	300cc x 19mm Dia Bolt Fix P.A.A
DSPH430/BT/450/19/PA	450cc x 19mm Dia Bolt Fix P.A.A
DSPH430/BT/600/19/PA	600cc x 19mm Dia Bolt Fix P.A.A



'D' Pull Handle



'Tee' Pull Handle



'Cranked' Pull Handle

Round Rose for Pull Handles

Ref. No.	Description
DSOR/5	Round Rose 5mm to suit 19/22mm Dia Pull Handles
DSOR/10	Round Rose 10mm to suit 19/22mm Dia Pull Handles



Aluminium Hardware

Accessories

Ref. No.	Description
DSEE/5/PA	5mm x 54mm Euro Escutcheon P.A.A
DSE0/5/PA	5mm x 54mm Oval Escutcheon P.A.A
DSEK/5/PA	5mm x 54mm Keyhole Escutcheon P.A.A
DSEB/5/PA	5mm x 54mm Blank hole Escutcheon P.A.A
DSTI/5/PA	5mm x 54mm Thumbturn & Ind set P.A.A
DSLAT/5/PA	5mm x 54mm Less Abled Thumbturn & Ind set P.A.A.
DSEE/10/PA	10mm x 54mm Euro Escutcheon P.A.A
DSE0/10/PA	10mm x 54mm Oval Escutcheon P.A.A
DSEK/10/PA	10mm x 54mm Keyhole Escutcheon P.A.A
DSEB/10/PA	10mm x 54mm Blank hole Escutcheon P.A.A
DSTI/10/PA	10mm x 54mm Thumbturn & Ind set P.A.A.
DSLAT/10/PA	10mm x 54mm Less Abled Thumbturn & Ind set P.A.A.
DSCPE/PA	EURO Cylinder Pull P.A.A.
DSCPO/PA	OVAL Cylinder Pull P.A.A.
DSUCPK/PA	KEYHOLE Cylinder Pull P.A.A.
DSCPR/PA	ROUND Cylinder Pull P.A.A.
DSCPB/PA	BLANK Cylinder Pull P.A.A.
DSHC1/PA	Buffered Hat & Coat Hook P.A.A.
DSHC2/PA	Hat & Coat Hook P.A.A.
DSHC3/PA	Single Coat Hook P.A.A.
DSOR/19/5/PA	5mm x 54mm On Rose set for 19mm Pull Handles P.A.A.
DSOR/22/5/PA	5mm x 54mm On Rose set for 22mm Pull Handles P.A.A.
DSOR/19/10/PA	10mm x 54mm On Rose set for 19mm Pull Handles P.A.A.
DSOR/22/10/PA	10mm x 54mm On Rose set for 22mm Pull Handles P.A.A.
DSQDS1/PA	45mm Oval Door Stop P.A.A.
SDS3/PA	80mm Projection Door Stop P.A.A.



Aluminium Levers on Plate

Aluminium Levers on Concealed Plate will be available for both UK and European Lock Cases and represents the widest range possible to suit the UK Commercial and Public Utility Sectors.



Square Face Fix Plate (19mm Lever)

Ref. No.	Description
DSL101A/19/E/PA	19mm EURO 165 x 165 x 3mm P.A.A 10mm sprung
DSL101A/19/B/PA	19mm BATH 165 x 165 x 3mm P.A.A 10mm sprung
DSL101A/22/E/PA	22mm EURO 165 x 165 x 3mm P.A.A 10mm sprung
DSL101A/22/B/PA	22mm BATH 165 x 165 x 3mm P.A.A 10mm sprung

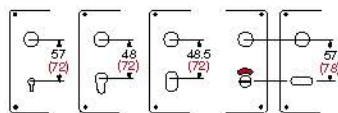

(European Sizes)

**EUROPEAN SIZES
ALSO AVAILABLE**

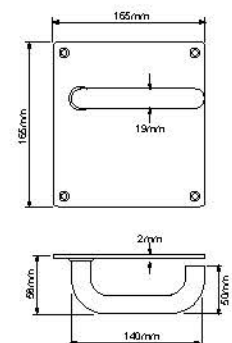

Oblong Face Fix Plate (19mm Lever)

Ref. No.	Description
DSL101B/19/E/PA	19mm EURO 165 x 55 x 3mm P.A.A 10mm sprung
DSL101B/19/B/PA	19mm BATH 165 x 55 x 3mm P.A.A 10mm sprung
DSL101B/22/E/PA	22mm EURO 165 x 55 x 3mm P.A.A 10mm sprung
DSL101B/22/B/PA	22mm BATH 165 x 55 x 3mm P.A.A 10mm sprung

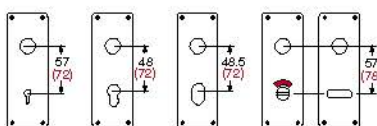

(European Sizes)

**EUROPEAN SIZES
ALSO AVAILABLE**

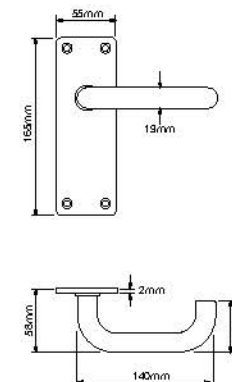

Nylon Coated Hardware

The DoorSpek Range of Nylon Coated Hardware offers the facility to colour co-ordinate a complete door set arrangement of DoorSpek Hardware in a Single Colour. Ideally suited for NHS type establishments. (Price and lead times upon application)

Ref. No.	Description
DSL101/U/304/COL	DSL101 "Return" lever s.s.s. 6mm sprung
DSP4/COL	350mm X 75mm Blank Hand Plate
DSPH402/BT/425/22/SP/COL	DSPH402 "D" 425 x 22mm, Bolt Fix s.s.s. Pull Handle
DSEE/SP/5/COL	5mm x 54mm Dia Euro Escutcheon s.s.s.
DSTISP/5/COL	5mm x 54mm Dia Thumbturn & Ind set s.s.s.
DSLATISP/5/COL	5mm x 54mm Dia Less Able Thumbturn & Ind set s.s.s.
DSH51BB43PC000/COL	DSH51BB 4x3x3mm (SQ) Powder Coated Hinge



Round Bar Levers



Designer Levers



Bronze Colour Matched Suite



Hat & Coat Hook

Hinges

Pull Handles

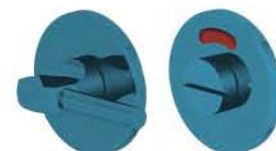

Less Able Turn & Indicator



Turn & Indicator

Floor Springs

The DoorSpek Range of Floor Springs are heavy duty, they are suitable for single or double swing applications in high traffic areas.

- Cam Action Floor Springs
- Fully EU Certified
- Choice of Fixed Power Size 3 or Power Size 4
- Adjustable Latch Action & Closing Speed
- Backcheck as standard
- Fixed Power Size 3 suitable for Doors up to 105kg & 950mm wide.
- Fixed Power Size 4 suitable for Doors up to 150kg & 1100mm wide.
- 25 Year Guarantee
- Available in Satin Stainless Steel or Polished Brass

CE

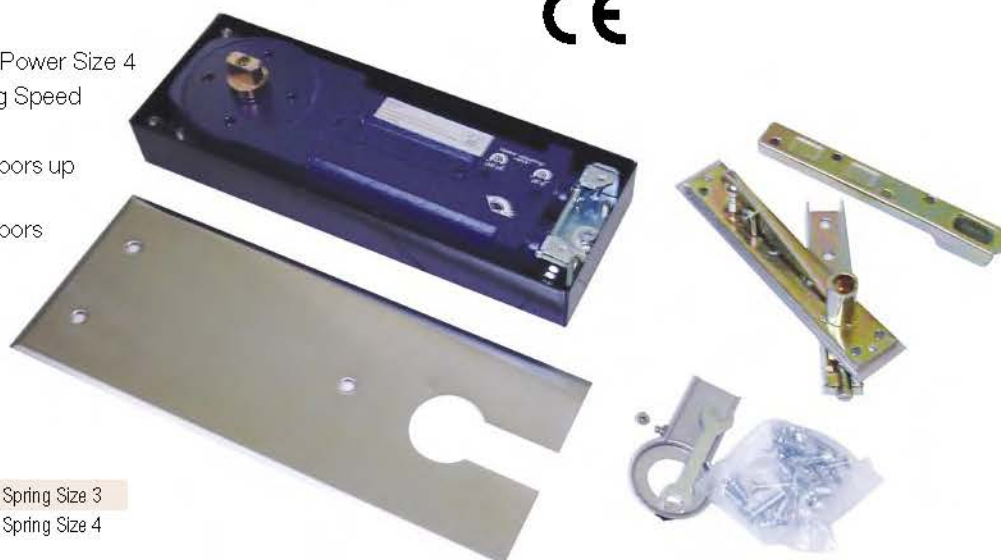

Ref. No.	Description
DSFS3	Fixed Power Cam Action Floor Spring Size 3
DSFS4	Fixed Power Cam Action Floor Spring Size 4

Door Closers

DoorSpek brings together a range of Door Closers to suit most applications. The range comprises of 5 Door Closers which are all CE certificated and Fire Tested. The Range comes in various sizes to suit door widths from 850mm to 1450mm & doors with mass door weights from 60Kg up to 120Kg.

DS7095 Adjustable Friction Restraining Stay Surface Mounted

- Suitable for use with Timber, Steel and Aluminium windows or light doors
- Allows opening between 90° - 100° (by position) ■ Choice of finishes
- Aluminium extruded channel with steel arm & fixing plate



DS3-BUDGET Budget Closer Fixed Power Size 3

- EN 1154 performance tested
- EN 1634 fire tested
- CE Marked
- Power size 3
- Suitable for doors up to 60kg and/or 950mm wide
- Rack & pinion mechanism
- Universal application
- Die cast body ■ Snap-fix arm set



Ref. No.	Description
DS3-BUDGET	Silver Body & Arm Set only (no cover)



DS3 Power Size 2-4 (by position)

- EN 1154 performance tested
- EN 1634 fire tested
- CE marked EN3
- CERTIFIRE Approved
- Power size 2 - 4 by position
- Suitable for doors up to 80kg and/or 1100mm wide
- Rack & pinion mechanism
- Universal application
- Die cast body
- Choice of adjustable snap-fix arm or adjustable flat-bar arm



Ref. No.	Description
DS3-SBO	Silver Body & Arm set only (no cover)
DS3-SC	Silver body c/w Silver Radius Cover & Arm set
DS3-SNP	Silver body c/w Satin Nickel Plated Radius Cover & Arm set
DS3-PNP	Silver body c/w Polished Chrome Radius Cover & Arm set
DS3-BP	Silver body c/w Brass Radius Cover & Arm set
DS3-COL	Silver body c/w Colour Coated Radius Cover & Arm set
FBA-S	Hold Open Arms Silver
FBA-SNP	Hold Open Arms Satin Nickel
SA-S	Slide Arms Silver only

Door Closers

DS2-4

Power Adjustable Size 2-4



- Delayed Action, Backcheck & Adjustable Closing Speed
- EN 1154 performance tested
- EN 1634 fire tested
- CE marked EN3
- CERTIFIRE Approved
- Adjustable Power size 2 - 4
- Suitable for doors up to 80kg and/or 1100mm wide
- Rack & pinion mechanism
- Universal application
- Die cast body
- Choice of adjustable snap-fix arm or adjustable flat-bar arm



Ref. No.	Description
DS2-4SBO	Silver Body & Arm set only (no cover)
DS2-4SC	Silver body c/w Silver Radius Cover & Arm set
DS2-4SNP	Silver body c/w Satin Nickel Plated Radius Cover & Arm set
DS2-4PNP	Silver body c/w Polished Chrome Radius Cover & Arm set
DS2-4BP	Silver body c/w Brass Radius Cover & Arm set
DS2-4COL	Silver body c/w Colour Coated Radius Cover & Arm set
DS2-4SARM	Hold Open Arms Silver
DS2-4SNPARM	Hold Open Arms Satin Nickel
DS2-4SSARM	Slide Arms Silver only

DS2-5

Power Adjustable Size 2-5



- Delayed Action, Backcheck & Adjustable Closing Speed
- EN 1154 performance tested
- EN 1634 fire tested
- CE marked
- CERTIFIRE Approved
- DDA Tested/Compliant
- Power adjustable 2 - 5 by spring
- Suitable for doors up to 100kg and/or 1250mm wide
- Rack & pinion mechanism
- Universal application
- Adjustable closing speed & latch action
- Extruded aluminium body



Ref. No.	Description
DS2-5SBO	Silver Body & Arm set only (no cover)
DS2-5SC	Silver body c/w Silver Radius Cover & Arm set
DS2-5SNP	Silver body c/w Satin Nickel Plated Radius Cover & Arm set
DS2-5PNP	Silver body c/w Polished Chrome Radius Cover & Arm set
DS2-5BP	Silver body c/w Brass Radius Cover & Arm set
DS2-5COL	Silver body c/w Colour Coated Radius Cover & Arm set
DS2-5SARM	Hold Open Arms Silver
DS2-5SNPARM	Hold Open Arms Satin Nickel
DS2-5SSARM	Slide Arms Silver only

Automatic Door Operators & Accessories

'Champion' Automatic Door Operator

Automatic door operator allows user to operate door as normal or open using push button or PIR. Features a push and go function.

- Compact size: 400mm x 80mm x 80mm
- Simple installation
- The Champion® can be mounted either on or above the door
- Robust drive unit with 12vDC geared motor
- Anti-crushing device during opening & closing cycles with adjustable motor cut out delay
- Push & Go Function
- Easy to open & close door manually if power fails
- Adjustable articulated operating arm or slide arm option
- Wide choice of Accessories e.g. PIRs, Pushbuttons etc
- Remote Control with 4 Channels
- Keypad option (extra)
- Battery back-up included
- Electric lock interface
- Automatic door closing option with variable time delay
- Guaranteed 2 years ■ CE, EMC Compliant
- Suitable for doors up to 120kgs ■ Weight 4 kg
- Motor 12vDC rated 15w
- Optical Encoder - Controls door movement, allows door to close from last position. Automatically sets the door close position to 90 degrees, dipswitch allows 100, 110 or 120 degrees opening.
- Compatible with all door actuation interfaces



Power Supply

- Input Voltage 240vac 50hz
- 12vdc supply for accessories



Accessories



Push Pad Button



Heavy Duty Push Pad Button



Domino PIR Sensor



Safety Sensor



Break Glass Unit



3 Position Keyswitch

Installation

If you require a quotation for installation please contact our sales office who can obtain a supply and fit quotation.

Installation available for:

- Door Operators • Door retainers • Access Control

Installations are also available for other products please contact us for more details, prices and to organise a site survey.

Ref. No.	Description
CHAMP01	Automatic Door Operator with Clutch Mechanism
DSSS340	Safety Sensor - 340mm
DSSS700	Safety Sensor - 700mm
DSDPIRS	Domino PIR Movement Sensor
DSPPB	Push Pad Button
DSEBLPP02	Heavy Duty Push Pad Button - Flush Mount
DSSBB03	Surface Housing to Suit Heavy Duty Push Pad Button
DSPDBGUR	Resettable Emergency Break Glass Unit
DS3POS	3 Position Key Switch - Flush Mount
DSSGSH	Surface Housing to Suit Key Switch

Concealed Door Closers

Astra 3000 Series

NEW

The Astra 3000 series incorporates 3 door controls of varying power with adjustable closing speed and latching action. The Astra 3001, 3002 and 3003 are tested to EN1634-1 for use on a 1 hour and 1/2 hour fire door set.

Suitable for use in accordance with building regulations 2000 approved document B for fire safety and approved document M for access to and use of buildings.

- Astra 3003 tested in accordance with EN 1154 (awaiting final 3rd party accreditation).
- Non-handed, suitable for use on either right or left hand doors.
- Available in Brass, Chrome or Satin finish. Square or Radius plates.
- 10 Year Guarantee.
- Fixing Jig
- Easy to fit with AST9003 Fitting Jig - available separately.

Ref. No.	Description
	Fixed Power Size 1
AST3001BF	Adjustable, controlled concealed hydraulic door closer Brass finish
AST3001CF	Adjustable, controlled concealed hydraulic door closer Chrome finish
AST3001SF	Adjustable, controlled concealed hydraulic door closer Satin finish
	Fixed Power Size 2
AST3002BF	Adjustable, controlled concealed hydraulic door closer Brass finish
AST3002CF	Adjustable, controlled concealed hydraulic door closer Chrome finish
AST3002SF	Adjustable, controlled concealed hydraulic door closer Satin finish
	Fixed Power Size 3
AST3003BF	Adjustable, controlled concealed hydraulic door closer Brass finish
AST3003CF	Adjustable, controlled concealed hydraulic door closer Chrome
AST3003SF	Adjustable, controlled concealed hydraulic door closer Satin finish
AST9003	Fitting jig for ASTRA3000 Series Door Closers

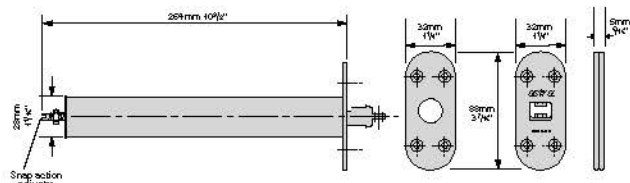

Astra 1000 Series

Manufactured in the UK to British Standard EN1634-1 and suitable for use on 1/2 and 1 hour fire doors, these door closers incorporate a unique hydraulic piston assembly offering a controlled rate of door closure. The 1002 closer benefits from the addition of a high strength spring, both types of closers have an adjustable latching action.

Ref. No.	Description
AST1001BFS	Concealed hydraulic door closer Brass finish
AST1001BFS	Concealed hydraulic door closer Chrome finish
AST1001SFS	Concealed hydraulic door closer Satin finish
AST1002BFS	High strength concealed hydraulic door closer Brass finish
AST1002CFS	High strength concealed hydraulic door closer Chrome finish
AST1002SFS	High strength concealed hydraulic door closer Satin finish

- Non-handed, suitable for use on either right or left hand doors.
- Available in Brass, Chrome or Satin finish.
- Square or Radius plates.
- 10 Year Guarantee.

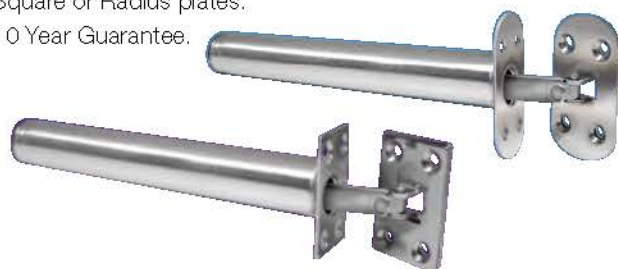

Astra Gibcloser

Designed for light weight internal doors, incorporating a spring compressed in the door and anchored to plates on the door jamb. Tested and proved suitable for use on a 1/2 hour and 1 hour fire door. Continuous in-house testing up to 500,000 cycles. Suitable for use on a 68kg/150lb fire door. The Gibcloser should be fitted to the door with a pair of ball bearing hinges and a good quality latching mechanism.

Ref. No.	Description
DSC31	Concealed spring door closer Brass finish
DSC33	Concealed spring door closer Chrome finish

- Non-handed, suitable for use on either right or left hand doors.
- Available in Brass or Chrome finish.
- Square or Radius plates.
- 10 Year Guarantee.



Panic & Emergency Exit Hardware

The DoorSpek range comprises vertical bolt and rim latch variations of both push bar and push pad operated devices. All variations have the following features:

- Non Handed can be reversed on site for left or right hand applications
- Low projection of devices from door face
- Tested for use on fire doors
- Can be fitted with No.8 woodscrews (provided), M4 Machine screws or self tapping screws
- Designed to fully comply with either EN1125 or EN179 European standards & CE marked for safety
- Silver powder coated finish as standard

NEW

CE

DS991 Panic Latch (Reversible)

Designed to satisfy the requirements of EN1125 for Panic applications the DoorSpek push bar panic latch has the following features:

- Suitable for single doors and the active leaf of a rebated double door.
- Supplied left or right hand but can be reversed on site.
- Supplied with a cast universal latch keep for both single and rebated double door applications. On single doors the keep can be surface mounted or morticed into the frame.
- Available with hold-back. Can be used on Fire Doors if the doors have been fire tested in the unlatched condition.
- Suitable for doors up to 1300mm wide and 2500mm high.



DS991/SE
Panic Latch
(right hand
illustrated)

DS993 Emergency Latch (Reversible)

Designed to satisfy the requirements of EN 179 for Emergency Exit applications. Features as for DS991 Panic Latch.

Ref. No.	Description
DS991/SE	Panic Latch
DS991/SE/HB	Panic Latch with Hold Back
DS993/SE	Emergency Latch
DS993/SE/HB	Emergency Latch with Hold Back



Universal Latch Keep supplied with Push Bar and Push Pad Latch Units, for use on single and rebated double door Applications.

DS993/SE
Emergency Latch
(right hand illustrated)



DS995 Panic Actuator Unit DS996 Emergency Actuator Unit

A Panic and Emergency Actuator Unit is available with a Mortice Nightlatch which offers an increase in security against the traditional Panic or Emergency Latch Units.

Ref. No.	Description
DS995/SE/72	Panic Actuator with N/Latch 72mm crs with reversible latch
DS995/SE/72/AT	Panic Actuator with N/Latch 72mm crs with Anti-Thrust with reversible latch
DS996/SE/72	Emergency Actuator with N/Latch 72mm crs with reversible latch
DS996/SE/72/AT	Emergency Actuator with N/Latch 72mm crs with Anti-Thrust with reversible latch
DS/RF	Round Ended Forend for Night Latch 72mm crs

CE



DS995/SE/72/AT
Panic Actuator with
Night Latch, Anti-Thrust
with Reversible Latch

DS990 Outside Access Devices

Access from the outside of a door fitted with panic or emergency exit hardware is via an outside access device. DoorSpek offer lever or knob options, both of which can be locked or unlocked by a Euro Profile Cylinder.

- Suitable for use with DoorSpek latches & vertical bolts.
- Handed on site for use with Left or Right Hand applications.
- Bolt through fixing is durable and prevents removal of device from outside.
- Suitable for metal and timber doors up to 54mm thick.
- Designed to be used with a 40mm Single Euro Profile Cylinder.

Ref. No.	Description
DS990/SE/KN	Outside Access Device - Knob Operated (Cylinder not included)
DS990/SE/KN/C	Outside Access Device - Knob Operated (With Cylinder)
DS990/SE/LE	Outside Access Device - Lever Operated (Cylinder not include d)
DS990/SE/LE/C	Outside Access Device - Lever Operated (With Cylinder)



DS990/SE/KN



DS990/SE/LE

DS992 Panic Bolt

Designed to satisfy the requirements of EN1125 for Panic Applications. The DoorSpek Panic Bolt is supplied with a horizontal bar and vertical bolts which can be cut to size on-site. The DoorSpek push bar panic bolt has the following features:

- Suitable for single doors, non-rebated double doors or the inactive leaf of a rebated double door.
- Universal for left or right handed doors.
- Top and bottom shoots are fully adjustable with +/- 5mm of adjustment for perfect alignment and operation.
- Available with hold-back. Can be used on Fire Doors if the doors have been fire tested in the unlatched condition.
- Suitable for doors up to 1300mm wide and 2500mm high.

DS994 Emergency Bolt

For use in all emergency exit applications, the Push Pad Emergency Bolt is available with vertical rods for single doors, the inactive leaf of a rebated double door, or as a pair on non-rebated double doors. Features as DS992 Panic Bolt.

Ref. No.	Description
DS992/SE	Panic Bolt
DS992/SE/HB	Panic Bolt with Hold Back
DS994/SE	Emergency Bolt
DS994/SE/HB	Emergency Bolt with Hold Back

DOORSPEK PANIC HARDWARE WILL SOON BE AVAILABLE IN STUNNING BLACK & SIMULATED SATIN STAINLESS STEEL FINISHES - AVAILABLE SPRING 2010



Panic Hardware Accessories

Ref. No.	Description
DSL329.SP	'Easy Code' Outside Access Mechanical Digital Lock with Spindle
DS999/A	Adapter for Rim Cylinder with Panic and Emergency Latch Units
DSLB154	Rim Cylinder with 3 Keys
DS0402	40mm O/A Single Cylinder for Outside Access Device
DSU412	45mm O/A Single Cylinder for use with Mortice Night Latch to suit 44mm thick door
DS999/S	Additional 1200mm Shoot Bolt for extra high doors
DS999/G	Additional Guides
DS999/B	Shoot Bolt Connector
DS999/M	Micro Switched Slave Unit
DSR706	13mm Rebate Kit for 72mm crs Mortice Night Latch



DSL329.SP
Outside Access Mechanical Digital Lock with Spindle to suit DS991 and DS993 Latch Units.

NEW Touchbar Range

- Tested to EN1125
- Successfully completed 1,500,000 cycles (7.5 times the requirement of EN1125)
- Exceeded 240 hours in a salt spray test
- Non-handed
- Single Latch with Anti-thrust
- Two Point Locking uses Vertical Pullmans with Anti-thrust Burglar Proof Device
- Three Point Locking uses Horizontal Pullmans
- The cross bar supplied as standard, 1085mm long, which can be cut down to accommodate the door width.
- Finish Silver and PVD Stainless Steel effect



AVAILABLE SPRING 2010

Universal Door Set

The DoorSpek Universal Door Set is a range of door furniture that offers both adjustability and security, it is suitable for PVCu, Aluminium, Composite and Wooden door applications.

Door Lever Set with built in Cylinder Safe

This universal lever set combines stylish good looks with concealed fixings and built in cylinder safe features. The lever set has multi screw fixings to line up with most available locks. The lever operates with upward and downward movement and can be supplied unsprung or with a sprung cassette. Available in Stainless Steel or Aluminium with a choice of finishes including Satin Stainless Steel, Polished Stainless Steel, PVD Brass, Powder Coated & Bio-Free.

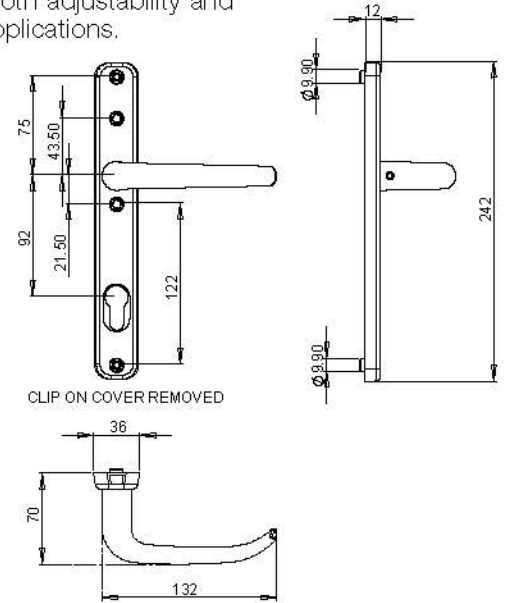

Ref. No.	Description
DSI 330	DoorSpeK Door Lever Set with Built in Cylinder Safe
DSH551BBADJ	Adjustable Hinge
DSLHDS	Left Hand Adjustable Lock Face Plates

Adjustable Hinge

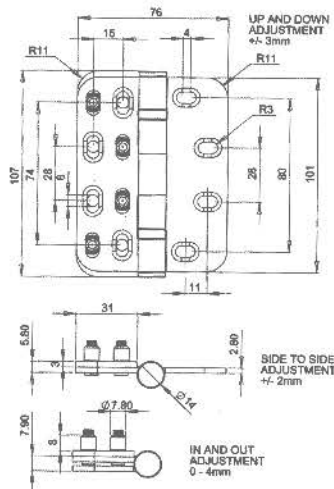

Designed to provide total adjustability whether used for UPVC, Aluminium, Composite or Wooden doors and frames. Certified to Grade 13, BSEN1935, CE 1121. Available in Stainless Steel and Mild Steel with a choice of finishes including Satin Stainless Steel, Polished Stainless Steel, Zinc Plated, Brass Plated, Chrome Plated, Powder Coated and Bio-Free. Sizes available: 101mm x 76mm & 101mm x 90mm.

Adjustable Lock Face Plates

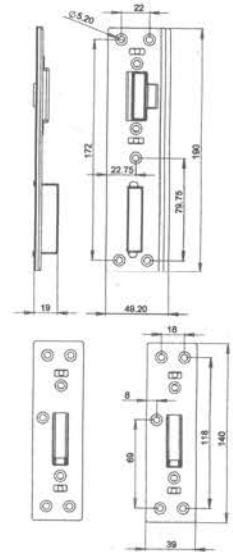

The door and window lock boxes provide full-notched adjustability. Available in Stainless Steel and Mild Steel with a choice of finishes including Satin Stainless Steel, Zinc Plated, Brass Plated and Powder Coated. Designed to suit 92mm cc lock.

NEW Unique Retro-Fit Multi-Point Handle Set

Exclusive New Design, Operates All Multipoint Locks

- Slideable escutcheon & moveable fixing lugs
- Fits all combinations of 8mm spindle, 68-92mm centres, 45-72mm door thickness
- No drilling of door required, uses existing holes
- Fitted using only a screwdriver
- Non-Handed - Fits Right & Left Handed Doors
- Choice of Gold, Chrome or White Finishes
- Minimum stock carried

Ref. No.	Description
DSRFMPH	Retro-Fit Multi-Point Handle Set



Digital Locks

Ergonomic design and simple operating procedure ensures access for authorised personnel only. Automatic locking until correct code is entered, anti-thrust latch plus over 8,000 different combinations to choose from provide greater security. Easy to fit, (can be supplied with fittings to suit doors up to 80mm thick) and with all parts and fittings included, it is ideal for low usage applications.

- NEW Tumbler Design eliminates recording errors
- 60mm Latch (50 & 70mm Available)
- 50,000 Cycle Test
- Optional Holdback (2200)
- Early Clear Plate
- Non-Handed
- Unconditional Guarantee
- Fully Mechanical
- 5 Year Guarantee
- Over 8000 Combinations

Ref. No.	Description
EU995PB	Push Button Digital Lock Polished Brass with Hold Back Facility
EU995SC	Push Button Digital Lock Satin Chrome with Hold Back Facility
EU996PB	Push Button Digital Lock Polished Brass
EU996SC	Push Button Digital Lock Satin Chrome
EU997SC	Push Button Digital Lock C/W Key Override Satin Chrome



Tubular Latches & Roller Catches

Heavy Duty Tubular Latch

Case depth 77mm, backset 57mm. Supplied with forend and strike in both Nickel and Brass finishes complete with separate strike back box.

- Mild steel case with passivated finish and brass latchbolt
- Springing is suitable for unsprung lever furniture
- Reversible latch
- Lockcases accept bolt through furniture fixings at 38mm centres
- Rebate set for 13mm rebates available in satin chrome and satin brass finishes

Ref. No.	Description
DSL520/77	Heavy Duty Tubular Latch, Case Size 77mm, Backset 57mm
DSL520/100	Heavy Duty Tubular Latch, Case Size 100mm, Backset 80mm



Heavy Duty Roller Catch

Case Depth 51mm. Supplied with forend and strike in nickel or brass finish.

- Mild steel case with powder coated finish
- Sprung Brass roller catch is adjustable from front face plate
- Nickel or Satin Brass forend and strike plate

Ref. No.	Description
DSL521N	Heavy Duty Roller Catch, Case Size 51mm, Nickel Finish
DSL521B	Heavy Duty Roller Catch, Case Size 51mm, Brass Finish

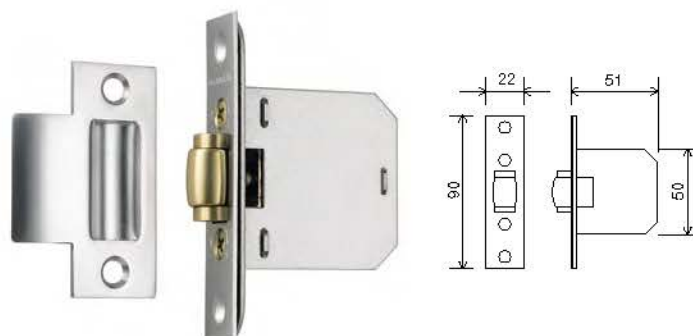

72mm European Lockcases

The DoorSpek 72mm European lock case range is fully compliant with EU Certification to EN12209 requirements and ideally suited for Non -Sprung Furniture. The range is compatible with most lever and euro profile cylinder ranges and consists of Sash, Dead, Latch, Bathroom, Escape & Nightlatch (the Escape Lock has 4 way handing and the Night Latch has an Anti-Thrust Snib).

- 60mm Backset
- Heavy duty sprung lock
- Spindle retaining cup
- Double throw deadbolt
- Easy reversible latch
- EN12209 Requirements
- Rebate kits available
- Suitable for sprung and unsprung levers
- Available in both square and radius forends
- Optional Seperate Forend (on application)

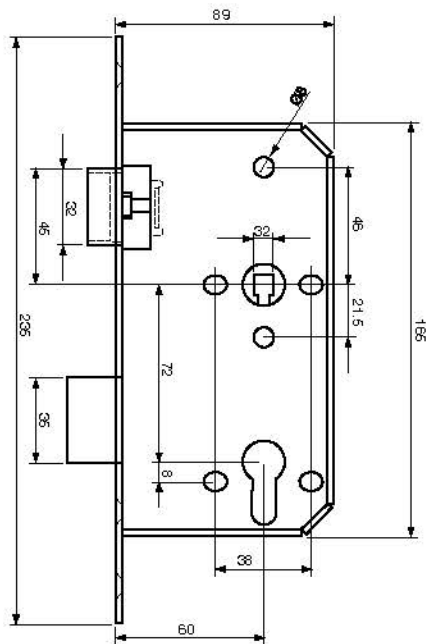

Ref. No.	Description
DSSLSP72	DoorSpek Fixed Forend "SashLock" 72mm cc SSS (Square)
DSBLSP72	DoorSpek Fixed Forend "Bathroom Lock" 78mm cc SSS (Square)
DSLLSP72	DoorSpek Fixed Forend "Latch Lock" 72mm cc SSS (Square)
DSSDSP72	DoorSpek Fixed Forend "Dead Lock" 72mm cc SSS (Square)
DSSNLSP72	DoorSpek Fixed Forend "Night Latch Lock" 72mm cc SSS (Square)
DSELSP72	DoorSpek Fixed Forend "Escape Sash Lock" 72mm cc SSS (Square)
DSSLRSP72	DoorSpek Fixed Forend "Sash Lock" 72mm cc SSS (Radius)
DSBLRSP72	DoorSpek Fixed Forend "Bathroom Lock" 78mm cc SSS (Radius)
DSLURSP72	DoorSpek Fixed Forend "Latch Lock" 72mm cc SSS (Radius)
DSSDRSP72	DoorSpek Fixed Forend "Dead Lock" 72mm cc SSS (Radius)
DSSNLRSP72	DoorSpek Fixed Forend "Night Latch Lock" 72mm cc SSS (Radius)
DSELRSP72	DoorSpek Fixed Forend "Escape Sash Lock" 72mm cc SSS (Radius)
DSSPINDLE	DoorSpek Split Pin Spindle For Escape Lock

European Lockcase Options

Range of Lockcases Available

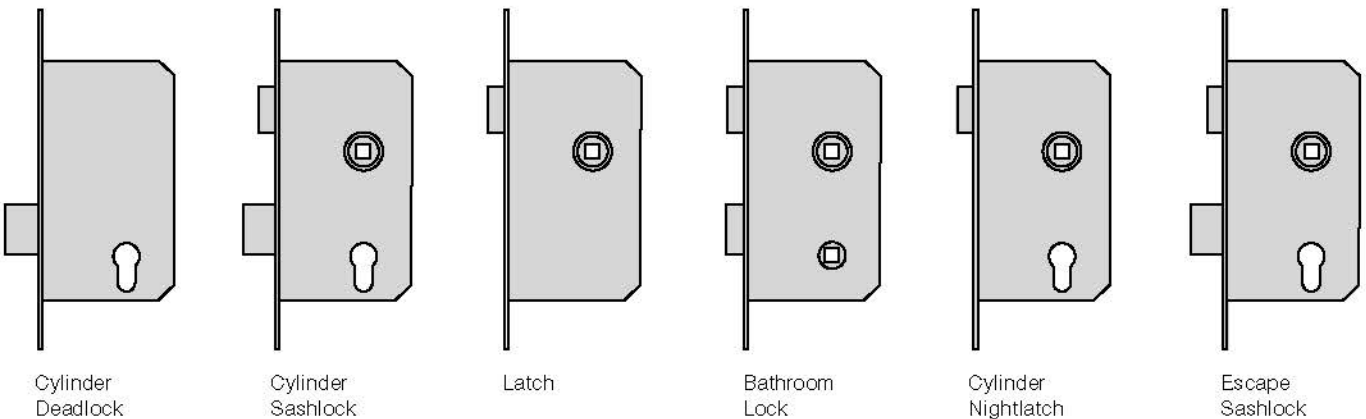

UK Lockcases

The UK Lock Range is a well established range which is ideal for the DoorSpek Furniture Ranges and compliments the DoorSpek Cylinder Range. These together are ideally suited for commercial and Public Utility establishments.

- Case depth of 2.5" or 3" finished with a black electro static coating.
- Solid Brass deadbolt with 13mm projection.
- All deadbolts (except bathroom locks) c/w anti saw hardened steel rollers.
- Solid Brass latch bolt with 13mm projection and externally accessible change of hand mechanism maintaining the integrity of lock.
- Heavy duty follower spring.
- Square forend/face plate finished in Polished Brass or Satin Stainless Steel.
- Electro Brass or Zinc Plate striker box.
- Twist reversible latchbolt
- 3 plated steel keys
- 10 year guarantee

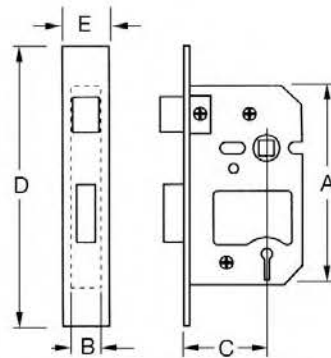

Dimensions

	A	B	C	D	E
Sashlock	108	15	45/57	153	25
Deadlock	70	15	45/57	121	25



Ref. No.	Description	Finish
EU904/67PB	Euro Sash Lock Case Only 2.5"	Polished Brass
EU904/67SS	Euro Sash Lock Case Only 2.5"	Satin Stainless
EU906/76PB	Euro Dead Lock Case Only 3"	Polished Brass
EU906/76SS	Euro Dead Lock Case Only 3"	Satin Stainless

Nightlatches

The DoorSpek Nightlatch Range comes in a variety of finishes and is ideally suited for Local Authority work and Maintenance Contracts where a simple cylinder operated surface mounted lock is required. The DoorSpek Cylinders compliment the range and allow for full masterkeying capabilities. The nightlatches come in both 40mm & 60mm backsets.

- Latchbolt mechanism
- Holdback facility & deadlocking snib
- Key operation from the outside, lever handle from inside
- For timber doors
- For door thickness 35-60mm
- Backset 60mm (1028), 40mm (1027)
- Finishes available: Brass, Chrome, White & Grey



Ref. No.	Description	Finish
DSDB750	Standard Cylinder Nightlatch with Brass Cylinder	Polished Brass
DSDBL751	Standard Cylinder Nightlatch with Brass Cylinder	White
SDB754	Standard Cylinder Nightlatch with Chrome Cylinder	Polished Chrome
DSB756	Standard Cylinder Nightlatch with Brass Cylinder	Dark Grey
DSB752	Narrow Cylinder Nightlatch with Brass Cylinder	Polished Brass
DSB753	Narrow Cylinder Nightlatch with Brass Cylinder	White
DSB755	Narrow Cylinder Nightlatch with Chrome Cylinder	Polished Chrome
DSB757	Narrow Cylinder Nightlatch with Brass Cylinder	Dark Grey
DSB153	Brass Rim Cylinder with 3 keys	Brass
DSB154	Nickel Rim Cylinder with 3 keys	Nickel
DSB155	Key Blanks	Brass

Metal Lockcases

The DoorSpek Metal Door Lock range is a comprehensive range of lockcases ideally suited for aluminium and metal framed door frames. The range of accessories makes these door locks ideal for retail shop fronts, garages etc.

- Range of backsets available
- Range of faceplate finishes
- Stainless steel laminated lockbolts
- Locks accept standard 17mm Europrofile cylinders and thumbturn

Europrofile Hookbolt/Barbolt Deadlocks

Ref. No.	Description
5222025	Narrow stile hookbolt lock to suit 17mm Europrofile cylinder - 25mm backset
5222025M	Narrow stile hookbolt lock to suit 17mm Europrofile cylinder - 25mm backset monitored 2 x SPDT microswitches inc.1M flying leads
5222030	Narrow stile hookbolt lock to suit 17mm Europrofile cylinder - 30mm backset
5222030M	Narrow stile hookbolt lock to suit 17mm Europrofile cylinder - 30mm backset monitored 2 x SPDT microswitches inc.1M flying leads
5222125	Narrow stile barbolt lock to suit 17mm Europrofile cylinder - 25mm backset
5222130	Narrow stile barbolt lock to suit 17mm Europrofile cylinder - 30mm backset

Europrofile Mortise Cylinder Deadlatches

Ref. No.	Description
5245701	Deadlatch to suit 17mm Europrofile mortise cylinder 25mm backset (RH)
5245702	Deadlatch to suit 17mm Europrofile mortise cylinder 25mm backset (LH)
5245703	Deadlatch to suit 17mm Europrofile mortise cylinder 30mm backset (RH)
5245704	Deadlatch to suit 17mm Europrofile mortise cylinder 30mm backset (LH)
5245705	Deadlatch to suit 17mm Europrofile mortise cylinder 38mm backset (RH)
5245706	Deadlatch to suit 17mm Europrofile mortise cylinder 38mm backset (LH)

Round Mortise Cylinder Barbolt Deadlocks

Ref. No.	Description
5218501	Narrow stile long throw barbolt deadlock to suit mortise cylinder 7/8" backset
5218502	Narrow stile long throw barbolt deadlock to suit mortise cylinder 31/32" backset
5218503	Narrow stile short throw barbolt deadlock to suit mortise cylinder 11/8" backset
5218504	Narrow stile short throw barbolt deadlock to suit mortise cylinder 11/2" backset

Round Mortise Cylinder Hookbolt/Barbolt Deadlocks

Ref. No.	Description
5218201	Narrow stile short throw barbolt deadlock to suit mortise cylinder 7/8" backset
5218202	Narrow stile short throw barbolt deadlock to suit mortise cylinder 31/32" backset
5218203	Narrow stile short throw barbolt deadlock to suit mortise cylinder 11/8" backset
5218204	Narrow stile short throw barbolt deadlock to suit mortise cylinder 11/2" backset
5218205	Narrow Stile hookbolt deadlock to suit mortise cylinder 7/8" backset
5218206	Narrow Stile hookbolt deadlock to suit mortise cylinder 31/32" backset
5218207	Narrow Stile hookbolt deadlock to suit mortise cylinder 11/8" backset
5218208	Narrow Stile hookbolt deadlock to suit mortise cylinder 11/2" backset

Round Mortise Cylinder Deadlatches

Ref. No.	Description
5245101	Deadlatch to suit round mortise cylinder 11/8" backset (RH)
5245102	Deadlatch to suit round mortise cylinder 11/8" backset (LH)
5245103	Deadlatch to suit round mortise cylinder 31/32" backset (RH)
5245104	Deadlatch to suit round mortise cylinder 31/32" backset (LH)

Faceplate Options



Metal Lockcases Accessories

Flush Bolts & Accessories

- Die-cast zinc alloy operating mechanism
- Available in Silver or Bronze finish
- Complete with bolt guide
- Spring loaded floor sockets available on request
- Flat or radius profiles available

Ref. No.	Description
60FSAA	Flat flushbolt SAA
60RSAA	Radius flushbolt SAA
60FBA	Flat flushbolt Bronze
60RBA	Radius flushbolt Bronze
60FS	Floor socket N/A
60BG	Bolt guide N/A



Flushbolts are used to facilitate the locking of the inactive leaf of a pair of aluminium, steel or timber doors. Complete with the necessary flushbolt guide and optional spring loaded floor sockets, the bolts allow both a secure and aesthetically pleasing locking solution.

Armoured Strike

- Armoured Strike
- Increased jamb protection

Ref. No.	Description
5212	Armoured strike For 220 lock
5213	Armoured strike faceplate 220 lock
5212M	Armoured strike c/w 1 x SPDT microswitch inc. 1M flying leads 220 lock



Paddle Handles & Levers

Both 456 lever handle and 459 paddle handle are designed to be ergonomically friendly and practical. Comes complete with cam plug which enables the handles to be used in conjunction with the 524510 deadlatch range of locks.

- Paddle handle for use with deadlatches
- Suits 44mm thick doors
- Cam plug non-handed, reversible in the field.



Ref. No.	Description
524591	Paddle handle c/w cam plug pull to left 4510 SAA
524592	Paddle handle complete with cam plug push to left 4510 SAA
524597	Paddle handle complete with cam plug pull to right 4510 SAA
524598	Paddle handle complete with cam plug push to right 4510 SAA

Ref. No.	Description
5245601	Lever Handles SAA c/w Cam plug (RH) for use with 4510
5245602	Lever Handles SAA c/w Cam plug (LH) for use with 4511

Mortice Cylinders

- Standard keyways
- Range of finishes
- 15/32" standard cylinder



5230 Round Mortice Thumbturn



5231 Round Mortice Cylinder Guard

Ref. No.	Description
5228	Round Mortice Cylinder Keyed to Differ SATIN
5229	Round Mortice Cylinder Keyed to Pass SATIN
5230	Round Mortice Thumbturn SATIN
5231	Round Mortice Guard SATIN
5241	Pair of 5228 round mortice cylinders complete with 3 Keys

Budget Cylinders

The DoorSpek Cylinder Range offers one of the most comprehensive ranges of Off-Set Cylinders in the market place. The Range offers two finishes; Brass and Satin Nickel Plated. The Range also offers 10 Stock Suites and full Masterkeying cylinder capabilities for both small and large complex Suites.

- 6 Pin Cylinder for Extra Security
- Choice of Nickel Plated or Brass Finishes
- Hardened Anti-Drill Steel Pin for Extra Strength

Euro Profile Double Cylinders

Ref. No.	Description
EUED251025	60MM = 25/10/25mm Euro Double
EUED251035	70MM = 25/10/35mm Euro Double
EUED301030	70MM = 30/10/30mm Euro Double
EUED301035	75MM = 30/10/35mm Euro Double
EUED301040	80MM = 30/10/40mm Euro Double
EUED301045	85MM = 30/10/45mm Euro Double
EUED301050	90MM = 30/10/50mm Euro Double
EUED351035	80MM = 35/10/35mm Euro Double
EUED351040	85MM = 35/10/40mm Euro Double
EUED401035	85MM = 40/10/35mm Euro Double
EUED351045	90MM = 35/10/45mm Euro Double
EUED351050	95MM = 35/10/50mm Euro Double
EUED351055	100MM = 35/10/55mm Euro Double
EUED351060	105MM = 35/10/60mm Euro Double
EUED401040	90MM = 40/10/40mm Euro Double
EUED401045	95MM = 40/10/45mm Euro Double
EUED401050	100MM = 40/10/50mm Euro Double
EUED401055	105MM = 40/10/55mm Euro Double
EUED451045	100MM = 45/10/45mm Euro Double
EUED451050	105MM = 45/10/50mm Euro Double
EUED451055	110MM = 45/10/55mm Euro Double
EUED501050	110MM = 50/10/50mm Euro Double



Euro Profile T/Turn Cylinders

EUET251025	60MM = 25/10/25mm Euro T/Turn
EUET301030	70MM = 30/10/30mm Euro T/Turn
EUET251045	80MM = 25/10/45mm Euro T/Turn
EUET351035	80MM = 35/10/35mm Euro T/Turn
EUET401040	90MM = 40/10/40mm Euro T/Turn
EUET451045	100MM = 45/10/45mm Euro T/Turn
EUET351040	85MM = 35/10/40mm Euro T/Turn
EUET401035	85MM = 40/10/35mm Euro T/Turn
EUET351045	90MM = 35/10/45mm Euro T/Turn
EUET451035	90MM = 45/10/35mm Euro T/Turn
EUET401045	100MM = 40/10/45mm Euro T/Turn
EUET401050	100MM = 40/10/50mm Euro T/Turn
EUET501040	100MM = 50/10/40mm Euro T/Turn
EUET351055	100MM = 35/10/55mm Euro T/Turn



Euro Single Cylinders

EUES25105	40MM = 25/10/5mm Euro Single
EUES30105	45MM = 30/10/5mm Euro Single
EUES35105	50MM = 35/10/5mm Euro Single



Euro H/Turn (Blind) Cylinders

EUHT51030	45MM = 5/10/30mm Euro H/Turn
EUHT51035	50MM = 5/10/35mm Euro H/Turn



Oval Profile Double Cylinders

EUOD251025	60MM = 25/10/25mm Oval Double
EUOD301030	70MM = 30/10/30mm Oval Double
EUOD351035	80MM = 35/10/35mm Oval Double



Oval Profile Single Cylinders

Ref. No.	Description
EUOS30105	45MM = 30/10/5mm



Oval Profile T/Turn Cylinders

EUOT251025	60MM = 25/10/25mm Oval Double
EUOT301030	70MM = 35/10/35mm Oval Double
EUOT351035	80MM = 35/10/35mm Oval Double



Screw-In Cylinders

EUSCREW/KA	Keyed Alike Single
EUSCREW/KA/PRS	Keyed Differ Single
EUSCREW/NP	Keyed Alike Pairs



Scandinavian Cylinders

EUSCANSETSNP	KEYED ALIKE INNER & OUTER SET
--------------	-------------------------------



Rim Cylinders

EURIMPB	EURIMPB Rim Cylinder
EURIMNP	EURIMNP Rim Cylinder



Keyblanks

EUKEYBLANK	KEYBLANKS
------------	-----------



Pinning Kits

EUPINKIT	PINNING KIT
----------	-------------

ALSO AVAILABLE

6 Pin Anti-Drill Factory Built Budget Stock Suite

- Grand Master Key Suite with 4 Sub Master Sections
- Open Profile ■ Ex Stock ■ 6 Pin Anti-Drill Cylinders

E.Suite Grand Master Key Suite or GMK Suite

- Manufactured within the EEC
- Manufactured under ISO 9002
- Large number of differs available ensuring scope for additions and extensions
- Oval, Euro & Rim cylinders all under the same section in Satin Nickel & Brass

The Doorspek range of hinges made from Stainless Steel or Mild Steel are both certified to Grade 13, BSEN 1935 & CE 1121.

All hinges are available in a variety of finishes.

Ref. No.	Description
DSH51BB43SP000	4 x 3 x 3mm (SQUARE) SSS
DSH551BB43SPR000	4 x 3 x 3mm (RADIUS) SSS
DSH551BB43SP005	4 x 3 x 3mm (ANTI-LIGATURE) SSS c/w screws
DSHRB/LH/SP	Rising Butt Left Hand SSS
DSHRB/RH/SP	Rising Butt Right Hand SSS
DSH51BB43BC000	4 x 3 x 3mm (SQUARE) Chrome
DSH51BB43ZP000	4 x 3 x 3mm (SQUARE) Satin Zinc Plated
DSH51BB43BB000	4 x 3 x 3mm (SQUARE) Polished Brass Plated
DSH51BB43PC000	4 x 3 x 3mm (SQUARE) Powder Coated

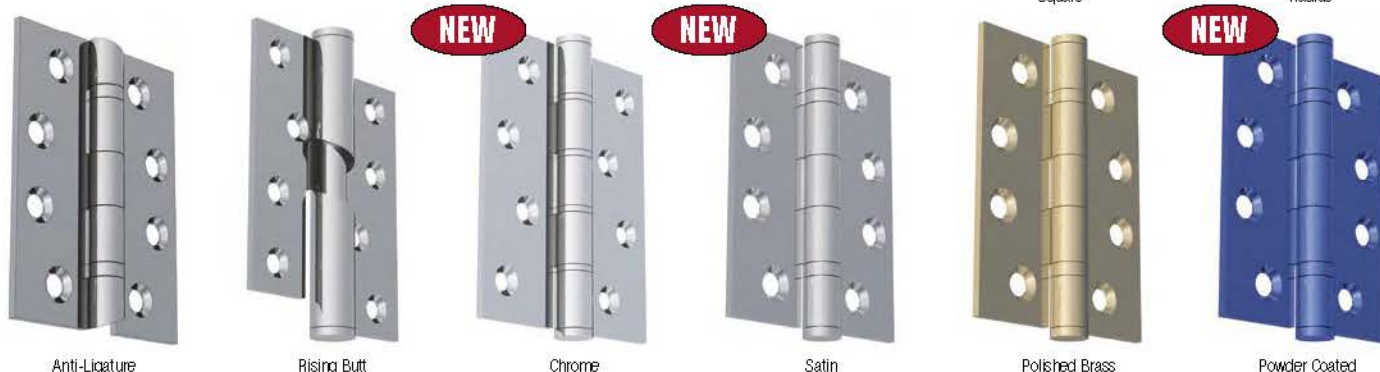
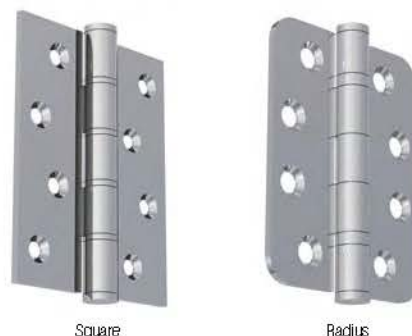

Fire Protection

Astro Quad Seal

Intumescent Fire, Smoke, Acoustic & Thermal Seals for fire door assemblies - four seals in one, the complete solution for fire, smoke, acoustic & thermal containment.



Ref. No.	Description
DS1004QWHT	QUAD SEAL WHITE 10x4x2100mm SELF-ADHESIVE
DS1004QBRN	QUAD SEAL BROWN 10x4x2100mm SELF-ADHESIVE
DS1504QWHT	QUAD SEAL WHITE 15x4x2100mm SELF-ADHESIVE
DS1504QBRN	QUAD SEAL BROWN 15x4x2100mm SELF-ADHESIVE
DS2004QWHT	QUAD SEAL WHITE 20x4x2100mm SELF-ADHESIVE
DS2004QBRN	QUAD SEAL BROWN 20x4x2100mm SELF-ADHESIVE

Astro Strip - Fire Only

An intumescent graphite based fire seal contained within a pvc sleeve will in the event of fire expand to many times its original volume & seal the gap around the door to provide a safe and effective barrier against the passage of fire.



Ref. No.	Description
AFFOB1042X	FIRE ONLY BROWN 10x4x2100MM SELF-ADHESIVE
AFFOW1042X	FIRE ONLY WHITE 10x4x2100MM SELF-ADHESIVE
AFFOB1542X	FIRE ONLY BROWN 15x4x2100MM SELF-ADHESIVE
AFFOW1542X	FIRE ONLY WHITE 15x4x2100MM SELF-ADHESIVE
AFFOB2042X	FIRE ONLY BROWN 20x4x2100MM SELF-ADHESIVE
AFFOW2042X	FIRE ONLY WHITE 20x4x2100MM SELF-ADHESIVE

Astro Strip - Fire & Smoke

An intumescent graphite based fire seal contained within a pvc sleeve will in the event of fire expand to many times its original volume & seal the gap around the door to provide a safe and effective barrier against the passage of fire, cold smoke & hot gasses.



Ref. No.	Description
AFFSB1042X	FIRE & SMOKE BROWN 10x4x2100MM SELF-ADHESIVE
AFFSW1042X	FIRE & SMOKE WHITE 10x4x2100MM SELF-ADHESIVE
AFFSB1542X	FIRE & SMOKE BROWN 15x4x2100MM SELF-ADHESIVE
AFFSW1542X	FIRE & SMOKE WHITE 15x4x2100MM SELF-ADHESIVE
AFFSB2042X	FIRE & SMOKE BROWN 20x4x2100MM SELF-ADHESIVE
AFFSW2042X	FIRE & SMOKE WHITE 20x4x2100MM SELF-ADHESIVE

Acoustic Perimeter Seals

A neat compact door stop frame seal which has proven to be an effective acoustic seal when tested in accordance with BS2750 and ISO140.3. It is quick and easy to install onto the door frame as a door stop. It is adjustable, by concealed fixing slots, for a precision fit.

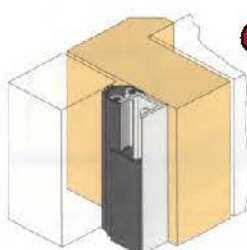

NEW

Ref. No.	Description
AFASPB	ACOUSTIC SMOKE PERIMETER SEAL BROWN 2100MM
AFASBPK	ACOUSTIC SMOKE PERIMETER SEAL BLACK 2100MM
AFASPW	ACOUSTIC SMOKE PERIMETER SEAL WHITE 2100MM

Fire Protection

Automatic Threshold Seals

A hot smoke automatic door bottom seal, with an extruded silicon sealing component that conforms to the 200 degrees celsius requirement of BCA c3.4. The seal is spring loaded to lift clear of the floor as soon as the door leaf is opened a few millimetres. There is a choice of rebated or surface mounted versions.

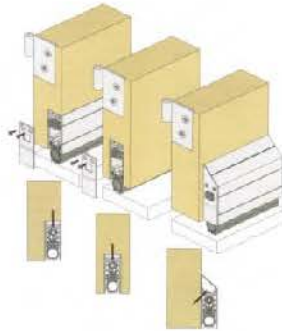

Ref. No.	Description
ADRP8Si/600	AUTO FULLY REBATED DOOR BOTTOM SEAL 600MM
ADRP8Si/820	AUTO FULLY REBATED DOOR BOTTOM SEAL 820MM
ADRP8Si/920	AUTO FULLY REBATED DOOR BOTTOM SEAL 920MM
ADRP8Si/1070	AUTO FULLY REBATED DOOR BOTTOM SEAL 1070MM
ADRP8Si/1220	AUTO FULLY REBATED DOOR BOTTOM SEAL 1220MM
ADRP9Si/600	AUTO SURFACE MOUNTED DOOR BOTTOM SEAL 600MM
ADRP9Si/720	AUTO SURFACE MOUNTED DOOR BOTTOM SEAL 720MM
ADRP9Si/820	AUTO SURFACE MOUNTED DOOR BOTTOM SEAL 820MM
ADRP9Si/920	AUTO SURFACE MOUNTED DOOR BOTTOM SEAL 920MM
ADRP9Si/1070	AUTO SURFACE MOUNTED DOOR BOTTOM SEAL 1070MM
ADRP9Si/1220	AUTO SURFACE MOUNTED DOOR BOTTOM SEAL 1220MM

Ironmongery Protection

A graphite based intumescent material available in various widths which can be easily cut to fit behind hinges, door closers and strike plates etc.



Ref. No.	Description
AFPTEC	INTUMESCENT HINGE & LOCK PROTECTION PACK 36 x 2 x 300MM 3No + 500 x 500 x .8MM X 1

Telescopic Letterbox Systems

Fully sealed letter plate flaps & back plate with intumescent fire liner. Adjustable door thickness from 40-65mm. Supplied with internal flap and aperture liner with choice of letter plate finish.



Ref. No.	Description
AFTLBFX/30SAA	L'BOX SYSTEM 30MIN 272x70MM SA ALUMINIUM
AFTLBFX/30PB	L'BOX SYSTEM 30MIN 272x70MM POLISHED BRASS
AFTLBFX/30PC	L'BOX SYSTEM 30MIN 272x70MM POLISHED CHROME
AFTLBFX/30SN	L'BOX SYSTEM 30MIN 272x70MM SATIN NICKEL
AFTLBFXC/30SAA	COMMERCIAL SYSTEM 30MIN 292x76MM SA ALUMINIUM
AFTLBFXC/30PB	COMMERCIAL SYSTEM 30MIN 292x76MM POLISHED BRASS
AFTLBFXC/30PC	COMMERCIAL SYSTEM 30MIN 292x76MM POL. CHROME
AFTLBFXC/30SN	COMMERCIAL SYSTEM 30MIN 292x76MM SATIN NICKEL

Finger Protectors

The Finger Keeper device prevents finger trapping accidents by totally covering the gap that is created on the hinge side of a door when it is in the open position. Once fitted it guarantees that fingers are safe from painful finger trapping injuries

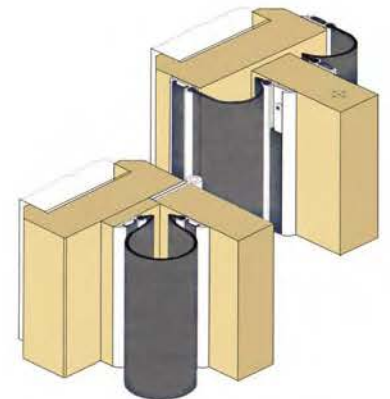

Ref. No.	Description
AFFKWH	FINGER KEEPER COMMERCIAL FRONT WHITE 1960MM
AFFKBR	FINGER KEEPER COMMERCIAL FRONT BROWN 1960MM
AFFKWHH	FINGER KEEPER COMMERCIAL REARGUARD WHITE 1960MM
AFFKBRH	FINGER KEEPER COMMERCIAL REARGUARD BROWN 1960MM
AFFKIND	FINGER KEEPER INDUSTRIAL 2100MM ANODISED SATIN CLEAR BLACK EPDM RUBBER SEAL

Fire Grilles

A durable ventilation grille which is easily mounted in doors & walls, and can provide in excess of 1/2 or 1 hour fire protection. The Grille comprises of a moisture resistant intumescent core within a galvanized steel frame with vermin proof 6mm steel mesh fitted to both faces. They have been tested to BS476: Part 22: 1987

Ref. No.	Description
AFFG22575	INTUMESCENT FIRE GRILLE 225MM X 75MM
AFFG225225	INTUMESCENT FIRE GRILLE 225MM X 225MM
AFFG300300	INTUMESCENT FIRE GRILLE 300MM X 300MM
AFP250100	STEEL LOUVERED FACE PLATES (250MMX100MM) SATIN ANODISED ALUMINIUM
AFP250250	STEEL LOUVERED FACE PLATES (250MMX250MM) SATIN ANODISED ALUMINIUM
AFP300300	STEEL LOUVERED FACE PLATES (300MMX300MM) SATIN ANODISED ALUMINIUM



Access Control Products



System X

The System X transmitter unit (TX) is positioned beside the fire alarm bell or sounder and incorporates the very latest radio technology. On identifying an alarm condition using acoustic technology the unit automatically signals to all linked devices, including **Dorgard X** and **Deafgard X** within a 100m range, subject to a site-survey.

System X is fully fail safe and complies with BS EN 1155 and BS 7273-4 category B. The link between the fire alarm sounder, transmitter and linked device(s) is completely wireless so installation is quick and easy. The transmitter constantly monitors the status of each linked device including the battery life and signal strength.

Dorgard X

Wedging open fire doors is illegal and dangerous. Dorgard X is the safe, legal and cost effective solution for all environments.

Ideal for hotels, restaurants and public areas where there is a requirement for fire doors to be held open.

Dorgard X Features:

- Wireless system ■ Fail to safe radio technology
- Automatically releases fire doors when receiving a signal from System X
- Ensures you comply with elements of the Disability Discrimination Act
- Easily fitted with minimal disruption
- Holds a fire door open at any chosen angle
- Timed daily release facility ■ Complies with BS 7273-4: category B

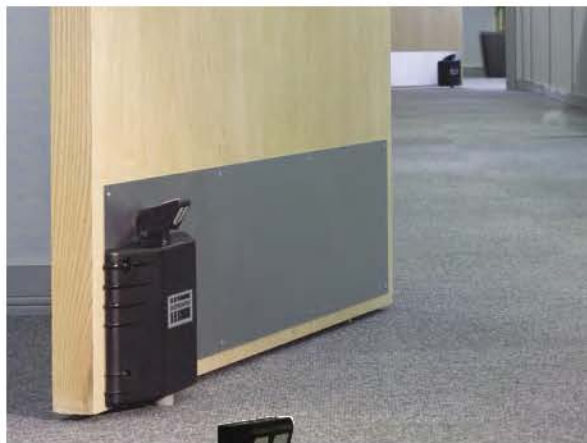

Deafgard X

1 in 7 people in the UK are deaf or hard of hearing, they are in danger of not hearing your fire alarm. Deafgard X is the safe, legal and cost-effective solution to communicate the sounding of the fire alarm to deaf and hard of hearing people.

Ideal for hotels and sleeping risk premises where there is a requirement from a deaf and hard of hearing person.

Deafgard X Features:

- Wireless system ■ Fail to safe radio technology
- Dual battery supply ■ Easily fitted with minimal disruption
- Automatically activates when receiving a signal from System X
- Ensures you comply with elements of the Disability Discrimination Act
- Alarm clock facility for deaf and hard of hearing people



Installation

If you require a quotation for installation please contact our sales office who can obtain a supply and fit quotation.

Installation available for:

- Door Operators • Door retainers • Access Control

Installations are also available for other products please contact us for more details, prices and to organise a site survey.

Ref. No.	Description
TRANSMITTER TX	DoorSpek System X Transmitter Unit
RECEIVER RX	DoorSpek System X Receiver Unit
DEAFGARD DFX	DoorSpek Deafgard X Wireless Alarm Unit

Access Control Products

Residential Electronic Locking System



SALTO
inspiredaccess

SALTO state-of-the-art electronic locking systems offer flexible and functional access control with a wide choice of programming options. SALTO access control systems are designed to work in a wire free environment so there is no need to hard-wire the building, allowing you to keep your original doors and locks in place. This makes installation fast, self contained and straightforward.

With SALTO you have the freedom to choose from a broad range of ID carriers including iButton touch keys or proximity RFID contactless tokens.

Features Include:

- The ability to add or delete carriers/tokens
- Wire free and battery powered, no complicated installation is needed and the existing mortise lock can be kept reducing the installation cost.
- The electronic cylinder is approved to the highest European security standards.
- Needs no computer, all key maintenance is done through a programming key and user's shadow keys. This allows up to 1000 system users.
- Available in a huge range of solutions depending on the door, as e-lock or electronic cylinder, wall readers, automatic door version, panic bar and euro mortise lock.
- Available passage mode in all versions, enabling the door to be always opened if needed.
- Emergency opening can be performed if needed through the EPS100.
- The system can be upgraded simply by using a Portable Programming Device (PPD) making it possible to upgrade to a ROM system or a data on card SVN system when your needs change.



Prices on Application (for all project work) Please Contact us for further details

Ref. No.	Description
E-Reader Wall reader Solutions	
DS-NWR	Narrow wall reader
DS-EWR	External wall reader c/w base
DS-IWR	Internal wall reader c/w base
DS-AVWR	Anti-Vandal wall reader c/w base
DS-OLCU	Off-line control unit
E-Handle Solutions	
DS-LLS/SSS	E-Handle latch lock set SSS finish 44-54mm door
DS-LLS/SB	E-Handle latch lock set SB finish 44-54mm door
DS-EHAN/SSS	E-Handle SSS finish 44-54mm door
DS-EHAN/SB	E-Handle SB finish 44-54mm door
E-Cylinder Solutions	
DS-EIEC/NP	Euro Internal Electronic Cylinder 3131 Nickel
DS-EIEC/SB	Euro Internal Electronic Cylinder 3131 Brass
DS-OIEC/NP	UK Oval Internal Electronic Cylinder 3131 Nickel
DS-OIEC/SB	UK Oval Internal Electronic Cylinder 3131 Brass
Control Equipment	
	Mifare Programming Equipment
DS-EBOU	Emergency Battery Override Unit
DS-CRAT	E-Cylinder tum removal Allen tool
DS-USB/PP	USB Portable Programmer
Ancillaries	
DS-PPCS	Prox Programming Card Set
DS-PUCS	Prox User Card Set
DS-PUFS	Prox User Fob Set
DS-PLMPC	Prox Latch mode Programming card
DS-EA9450IMM	Prox Demo Block

Access Control Products

Electric Strikes

IGE10M2FDS

ANSI Mortise Strike
12/24vDC, Fail Safe/Secure,
Short Plate

IGE102FDL

ANSI Mortise Strike
12/24vDC, Fail Safe/Secure,
Long Plate

EAGAER Rim Mortise Strike

12vAC/DC, Fail Secure



Exit Buttons

EBGB02

Green Dome Exit Button
Surface Mount

EBPP02 Weather Resistant Exit Button
Surface Mount

EBSS02 Vandal Resistant Exit Button
Surface Mount



Surface Magnets & Brackets



EA10001S



EA10010S

EAIGEM19005M Micro Magnet

12/24vDC, 600Kg Holding Force

EA10001S Slimline Mini Magnet

12/24vDC, 300Kg Holding Force

EA10010S Standard Magnet

12/24vDC, 500Kg Holding Force

EA300ZL Z & L Brackets

EA500ZL Z & L Brackets Std.



EAIGEM19005M

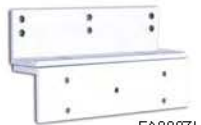

EA300ZL

Biometric Readers

TOC-120-001

1 Relay Biometric Fingerprint Reader Surface Mounted

TOC-120-411

1 Relay Integra Biometric Fingerprint Reader

Flush Fitting



TOC-120-001

TOC-120-411

Power Supplies & Batteries

1201-EC 12vDC 1 Amp PSU

1202-EC 12vDC 2 Amp PSU

1203-EMC 12vDC 3 Amp PSU

1205-EMC 12vDC 5 Amp PSU

EABAT-12/7 12vDC 7AH Battery



Acoustic Fire Door Retainers

FIR-DORGARD-R

Available in Black, Red, White, & Mahogany



Door Loops

EADLECON

Economy Door Loop
Plastic Ends

EADLARM Armoured Door Loop
Aluminium Ends

EADLCON Concealed Door Loop
Polished Chrome



Access Control Systems

SI-PASS EL500

Proximity Reader and Controller + PSU

Kit Includes:

BEW-PR500 Prox Reader

BEW-DC800 Door Controller

BEW-BA112 1 Amp 12vDC PSU



SIEMENS

Toilet Door Alarm Kit

DTA

Disabled Toilet Alarm Kit

BS8300:2001 Compliant

Kit Includes: External Indicator, Pull Cord, Remote Reset & Control Unit.



Entry Keypads

DIG-PROMI-K

Surface Mount
Black ABS Plastic

SEC-ACT10

Surface Mount
12/24v AC/DC

BEW-K42

Surface Mount
12/24v AC/DC



SIEMENS
BEW-K42

DIG-PROMI-K

ACT
SEC-ACT10

Video & Audio Entry Kits

VID-DK1S

1 Way Audio Entry Kit
C/W Handset & PSU

SDK4S 1 Way Video Entry Kit

C/W Handset, PSU & Integral Keypad



Access Control

Access Control Kits

NEW

Ref. No.	Description
DS/KEYPROX/KIT1	Single door keypad proximity kit c/w magnet
DS/KEYPROX/KIT2	Single door keypad proximity kit c/w mortice release
DS/KEYPROX/KIT3	Single door keypad proximity kit c/w rim release
DS/KEYPROX/KIT4	Double door keypad proximity kit c/w double magnet



KIT 1 Contains:

- 1 x Proximity reader c/w keypad & 10 fobs, 1-10,000 users IP65 rated weather and dust proof flush or surface mount
- 1 x Mini magnet surface mount 12/24vdc 300kg
- 1 x 300 series mini Z and L kit for inward open door
- 1 x 12vdc 1amp boxed power supply unit c/w battery backup facility (battery backup unit extra)
- Surface mount plastic exit button 1 gang size
- 1 x resettable break glass unit surface mount



KIT 3 Contains:

- 1 x Proximity reader c/w keypad & 10 fobs 1-10,000 users IP65 rated weather and dust proof flush or surface mount
- 1 x 12vdc 1amp boxed power supply unit c/w battery backup facility (battery backup unit extra)
- Surface mount plastic exit button 1 gang size
- 1 x resettable break glass unit surface mount
- 1 x Rim release 12/24vdc field switchable from fail safe to secure 750Kg hold force (1650lbs) medium to high security



KIT 2 Contains:

- 1 x Proximity reader c/w keypad & 10 fobs 1-10,000 users IP65 rated weather and dust proof flush or surface mount
- 1 x 12vdc 1amp boxed power supply unit c/w battery backup facility (battery backup unit extra)
- Surface mount plastic exit button 1 gang size
- 1 x resettable break glass unit surface mount
- 1 x Electric mortice release 12/24vdc c/w 1 x long &
- 1 x short face plate field switchable from fail safe to secure 1750 kg holding force (3850 lbs) medium to high security



KIT 4 Contains:

- 1 x Proximity reader c/w keypad & 10 fobs 1-10,000 users IP65 rated weather and dust proof flush or surface mount
- 1 x double mini magnet 12/24vdc surface mount
- 2 x 300 series mini Z and L kit for inward open door
- 1 x 12vdc 2amp power supply unit boxed with battery backup facility (battery backup unit extra)
- Surface mount plastic exit button 1 gang size
- 1 x resettable break glass unit surface mount



New Products

Coming Soon - Freedor Wireless swing-free hold open device that closes when the fire alarm sounds.

NEW
Compatible with
System X

Freedor is a wireless solution for holding open your fire doors safely and legally. The unit is located on or above the fire door with an articulated arm used to link the unit to the door. Freedor will automatically close the door in the event of the fire alarm sounding using acoustic technology.

Freedor X

Freedor X uses the unique radio technology of System X. System X is positioned beside the fire alarm bell or sounder. On identifying an alarm condition System X sends a radio signal to all Freedor X units to close the fire doors, preventing the spread of fire and smoke.

Features Include:

- Freedor features
- Wireless hold-open door closing device
- Adjustable closing speed
- Operates to Power Size 4 (80kg fire door)
- Holds open to a 90 degree angle
- Freeswing function
- Rotatable for right and left hand doors
- Fail-to-safe technology with minimum 12 month battery life
- Night-time release facility
- Complies with BS EN1154
- Acoustic and radio options available



Access Control Products

Access Control Fitting Guide

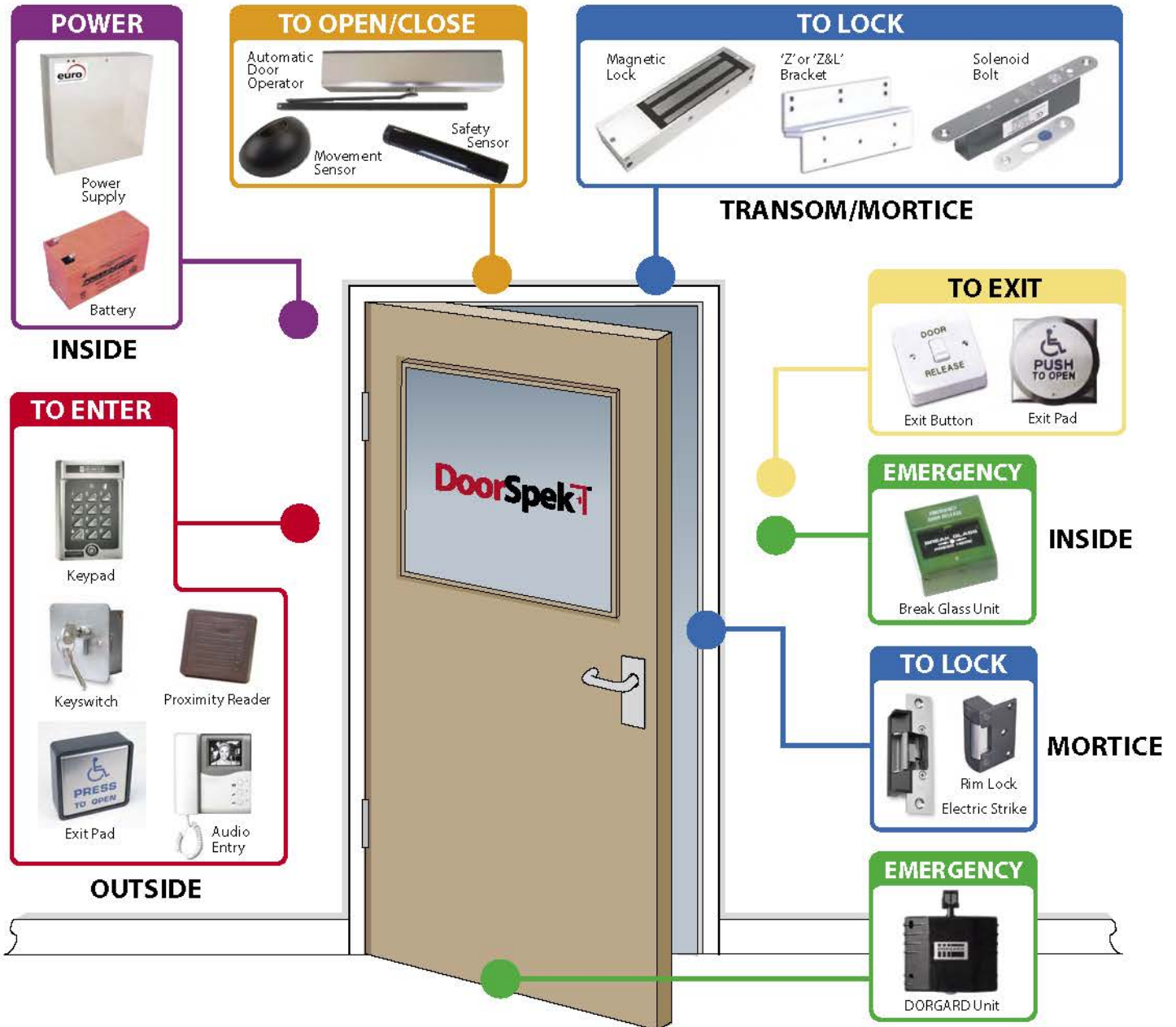

- TO LOCK** Method of securing the door by either magnet, strike, solenoid bolt or rimlock - **How do we lock the door?**
- TO ENTER** Secure method of entry by either code, key, swipe card, proximity reader/fob or audio/video entry - **How do we get in?**
- TO EXIT** Secure method of exit by either button or another reader/keypad - **How do we exit?**
- TO OPEN/CLOSE** Method of opening and dosing the door by automatic operation using movement and safety sensors - **How do we open & close the door?**
- EMERGENCY** What happens in an emergency e.g. Fire - **How do we exit in an emergency?**
- POWER** Is the door fail safe (unlocked) or fail secure (locked) if there is a power failure - **What if the power fails?**



Grant Haze London



The Range is specifically designed for:

- Public Utilities & Commercial Premises such as Schools, Universities, Hospitals, Care Homes and all NHS Establishments
- Local Authority & Commercial Buildings such as Housing Projects, Hotels & Offices.

Grant Haze London Ltd
Unit 22, Walthamstow Business Park
Clifford Road, Walthamstow, London.
E17 4SX
Tel: 020 8531 9696 - Fax: 020 8531 9678
email: sales@granthazelondon.co.uk