



SHOT PEENING APPLICATIONS



METAL IMPROVEMENT COMPANY
A Subsidiary of Curtiss-Wright Corporation

NINTH EDITION

TABLE OF CONTENTS

INTRODUCTION	3
--------------------	---

CHAPTER 1: THEORY

The Shot Peening Process	4
Shot Peening Residual Stress	5
Summation of Applied and Residual Stress	6
Application Case Study: <i>NASA Langley Crack Growth Study</i>	6
Depth of Residual Stress	7
Shot Peening Media	7
Effect of Shot Hardness	7

CHAPTER 2: RESPONSE OF METALS

High Strength Steels	8
Carburized Steels	9
Application Case Study: <i>High Performance Crankshafts</i>	9
Decarburization	9
Application Case Study: <i>Reduction of Retained Austenite</i>	10
Austempered Ductile Iron	10
Cast Iron	10
Aluminum Alloys	11
Application Case Study: <i>High Strength Aluminum</i>	11
Titanium	12
Magnesium	12
Powder Metallurgy	12
Application Case Study: <i>High Density Powder Metal Gears</i>	13

CHAPTER 3: MANUFACTURING PROCESSES

Effect on Fatigue Life	14
Welding	14
Application Case Study: <i>Fatigue of Offshore Steel Structures</i>	15
Application Case Study: <i>Turbine Engine HP Compressor Rotors</i>	15
Grinding	16
Plating	16
Anodizing	17
Application Case Study: <i>Anodized Aluminum Rings</i>	17
Plasma Spray	17
Electro-Discharge Machining (EDM)	17
Electro-Chemical Machining (ECM)	18
Application Case Study: <i>Diaphragm Couplings</i>	18

CHAPTER 4: BENDING FATIGUE

Bending Fatigue	19
Gears	19
Connecting Rods	20
Crankshafts	21
Application Case Study: <i>Diesel Engine Crankshafts</i>	21
Application Case Study: <i>Turbine Engine Disks</i>	21

CHAPTER 5: TORSIONAL FATIGUE

Torsional Fatigue	22
Compression Springs	22
Drive Shafts	23
Torsion Bars	23
Application Case Study: <i>Automotive Torsion Bars</i>	23

CHAPTER 6: AXIAL FATIGUE

Axial Fatigue	24
Application Case Study: <i>Train Emergency Brake Pin</i>	24
Application Case Study: <i>Auxiliary Power Unit (APU) Exhaust Ducts</i>	24

CHAPTER 7: CONTACT FAILURE

Fretting Failure	25
Application Case Study: <i>Turbomachinery Blades and Buckets</i>	25
Pitting	25
Galling	26

CHAPTER 8: CORROSION FAILURE

Corrosion Failure	27
Stress Corrosion Cracking	27
Application Case Study: <i>Fabrication of Chemical Handling Equipment</i>	28
Corrosion Fatigue	28
Application Case Study: <i>Sulfide Stress Cracking</i>	28
Application Case Study: <i>Medical Implants</i>	29
Intergranular Corrosion	29

CHAPTER 9: THERMAL FATIGUE & HEAT EFFECTS

Effects of Heat	30
Thermal Fatigue	31
Application Case Study: <i>Feedwater Heaters</i>	31

CHAPTER 10: OTHER APPLICATIONS

Peen Forming	32
Contour Correction	33
Work Hardening	33
Peentex sm	34
Engineered Surfaces	34
Application Case Study: <i>Pneumatic Conveyor Tubing</i>	35
Application Case Study: <i>Food Industry</i>	35
Exfoliation Corrosion	36
Porosity Sealing	36
Internal Surfaces and Bores	36
Dual (Intensity) Peening	37
The C.A.S.E. sm Process	38
On-Site Shot Peening	38
Strain Peening	39

CHAPTER 11: CONTROLLING THE PROCESS

Controlling the Process	40
Media Control	40
Intensity Control	41
Coverage Control	42
Automated Shot Peening Equipment	43
Application Case Study: <i>CMSP Increases Turbine Engine Service Life</i>	44
Specifying Shot Peening	45

CHAPTER 12: ADDITIONAL CAPABILITIES & SERVICES

Peenstress sm – Residual Stress Modeling	46
Laser Peening	46
Coating Services	47
Heat Treating	48
Valve Reeds – Manufacturing	48

APPENDIX:

Conversion Tables	50-51
MIC Technical Article Reprints	52-57
MIC Facilities Listing	58-59

Metal Improvement Company (MIC) is a world leader in providing specialized metal treatment services that enhance the performance and extend the life of components operating in a wide range of applications. Our services are an integral part of the manufacturing process for producing engineered products for the aerospace, automotive, chemical, medical, power generation and general industrial markets.

Through a network of over 50 facilities in North America and Europe, MIC provides the following metal treatment services:

Shot Peening – MIC has specialized in providing shot peening services to industry since 1945. Shot peening protects components against failure mechanisms such as fatigue, fretting fatigue and stress corrosion cracking. We continue to develop new processing techniques and equipment that help prevent premature part failures and enable designs to achieve their maximum potential.

Laser Peening – MIC is the world’s leading provider of laser peening services. With surgical precision, a unique high energy laser is fired at the surface of a metal part, generating pressure pulses of one million pounds per square inch. Similar to shot peening, the layer of beneficial compressive stress increases the component’s resistance to failure mechanisms, which translates to increased component life and reduced maintenance costs.

Peen Forming – Peen forming is a highly effective process for creating aerodynamic contours in aircraft wing skins and for straightening precision metal parts that have become warped due to prior machining, grinding or heat treating. The imparted residual compressive stresses from the shot peen forming process that shape the wing skins also increase their resistance to flexural bending fatigue and stress corrosion cracking.

Heat Treating – MIC specializes in the thermal processing of metal components used in a wide range of industries. Thermal processing relieves stresses within fabricated metal parts and improves their overall strength, ductility and hardness. By involving MIC at the planning stage of your project, we can recommend the configuration, alloy and thermal process to meet your design requirements.

Coating Services – Our E/M Coating Services Division has over 40 years of experience in applying critical tolerance coatings and is a pioneer in the development and application of solid film lubricant coatings. Selection of the proper coating can facilitate the use of less expensive metals, improve component wear life and reduce maintenance costs.

Each MIC facility maintains quality approvals appropriate to its customer base, such as FAA, CAA, Nadcap, QS 9000, ISO 9001, AS 9100 and TS16949 certifications.

Metal Improvement Company is a wholly-owned subsidiary of the Curtiss-Wright Corporation (NYSE:CW). Curtiss-Wright Corporation is a diversified global company that designs, manufactures and overhauls products for motion control and flow control applications in addition to providing metal treatment services. For more information about Curtiss-Wright visit www.curtisswright.com.

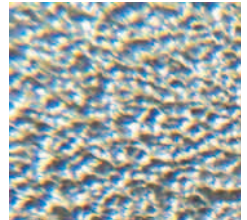

SHOT PEENING

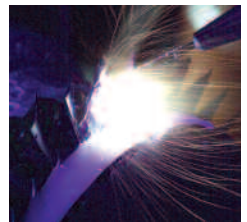

LASER PEENING



PEEN FORMING



HEAT TREATING



COATING SERVICES

THE SHOT PEENING PROCESS

Shot peening is a cold working process in which the surface of a part is bombarded with small spherical media called shot. Each piece of shot striking the metal acts as a tiny peening hammer imparting a small indentation or dimple on the surface. In order for the dimple to be created, the surface layer of the metal must yield in tension (**FIGURE 1-1**). Below the surface, the compressed grains try to restore the surface to its original shape producing a hemisphere of cold-worked metal highly stressed in compression (**FIGURE 1-2**). Overlapping dimples develop a uniform layer of residual compressive stress.

It is well known that cracks will not initiate nor propagate in a compressively stressed zone. Because nearly all fatigue and stress corrosion failures originate at or near the surface of a part, compressive stresses induced by shot peening provide significant increases in part life. The magnitude of residual compressive stress produced by shot peening is at least as great as half the tensile strength of the material being peened.

In most modes of long term failure the common denominator is tensile stress. These stresses can result from externally applied loads or be residual stresses from manufacturing processes such as welding, grinding or machining. Tensile stresses attempt to stretch or pull the surface apart and may eventually lead to crack initiation (**FIGURE 1-3**). Compressive stress squeezes the surface grain boundaries together and will significantly delay the initiation of fatigue cracking. Because crack growth is slowed significantly in a compressive layer, increasing the depth of this layer increases crack resistance. Shot peening is the most economical and practical method of ensuring surface residual compressive stresses.

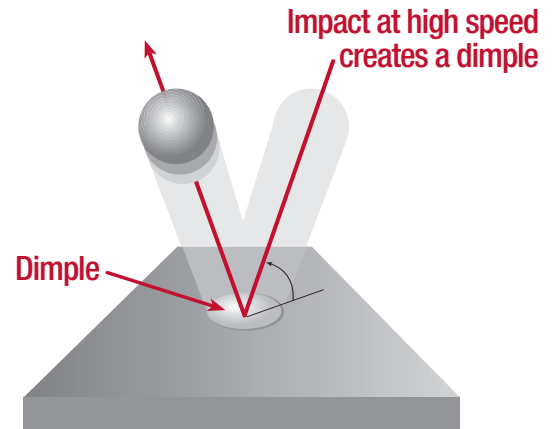

FIGURE 1-1 Mechanical Yielding at Point of Impact



FIGURE 1-2 Compression Resists Fatigue Cracking

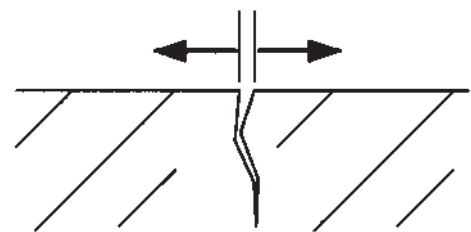
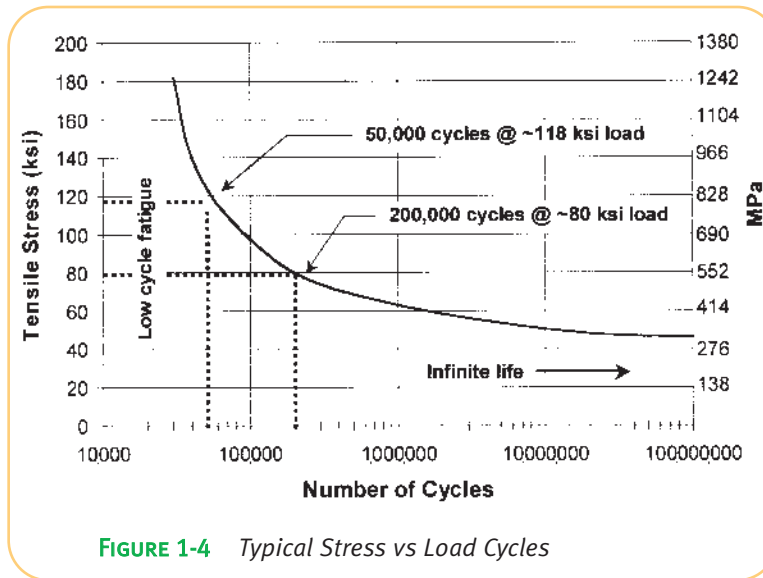

FIGURE 1-3 Crack Initiation and Growth Through Tensile Stress

Shot peening is primarily used to combat metal fatigue. The following points pertain to metal fatigue and its application to the Typical Stress versus Load Cycles graph shown in **FIGURE 1-4**.

- Fatigue loading consists of tens of thousands to millions of repetitive load cycles. The loads create applied tensile stress that attempt to stretch/pull the surface of the material apart.
- A linear reduction in tensile stress results in an exponential increase in fatigue life (Number of Load Cycles). The graph (**FIGURE 1-4**) shows that a 38 ksi (262 MPa) reduction in stress (32%) results in a 150,000 cycle life increase (300%).



SHOT PEENING RESIDUAL STRESS

The residual stress generated by shot peening is of a compressive nature. This compressive stress offsets or lowers applied tensile stress. Quite simply, less (tensile) stress equates to longer part life. A typical shot peening stress profile is depicted in **FIGURE 1-5**.

Maximum Compressive Stress –

This is the maximum value of compressive stress induced. It is normally just below the surface. As the magnitude of the maximum compressive stress increases so does the resistance to fatigue cracking.

Depth of Compressive Layer – This is the depth of the compressive layer resisting crack growth. The layer depth can be increased by increasing the peening impact energy. A deeper layer is generally desired for crack growth resistance.

Surface Stress – This magnitude is usually less than the Maximum Compressive Stress.

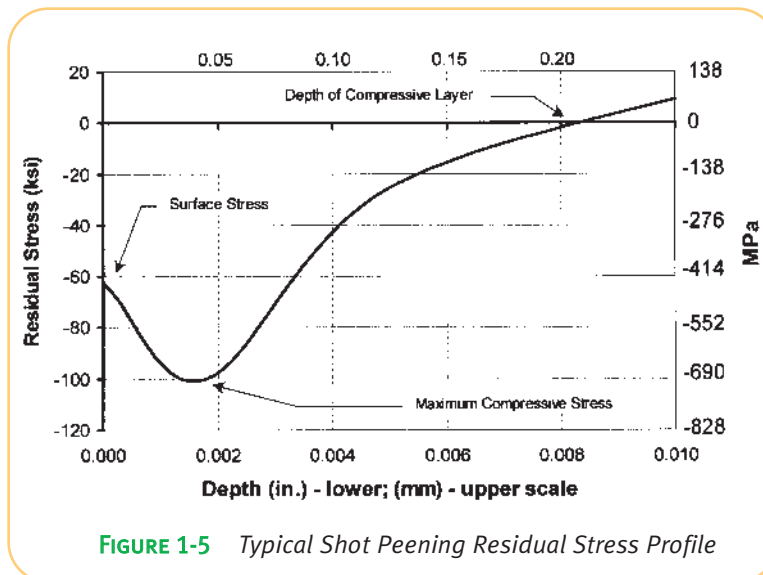

SUMMATION OF APPLIED AND RESIDUAL STRESS

When a component is shot peened and subjected to an applied load, the surface of the component experiences the net stress from the applied load and shot peening residual stress. **FIGURE 1-6** depicts a bar with a three-point load that creates a bending stress at the surface.

The diagonal dashed line is the tensile stress created from the bending load. The curved dashed line is the (residual) compressive stress from shot peening. The solid line is the summation of the two showing a significant reduction of tensile stress at the surface.

Shot peening is highly advantageous for the following two conditions:

- Stress risers
- High strength materials

Stress risers may consist of radii, notches, cross holes, grooves, keyways, etc. Shot peening induces a high magnitude, localized compressive stress to offset the stress concentration factor created from these geometric changes.

Shot peening is ideal for high strength materials. Compressive stress is directly correlated to a material's tensile strength. The higher the tensile strength, the more compressive stress that can be induced. Higher strength materials have a more rigid crystal structure. This crystal lattice can withstand greater degrees of strain and consequently can store more residual stress.

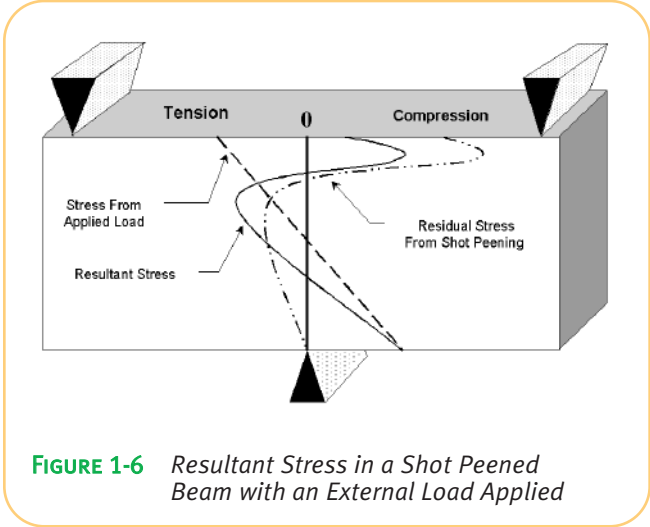

FIGURE 1-6 Resultant Stress in a Shot Peened Beam with an External Load Applied

APPLICATION CASE STUDY

NASA LANGLEY CRACK GROWTH STUDY

Engineers at NASA performed a study on crack growth rates of 2024-T3 aluminum with and without shot peening. The samples were tested with an initial crack of 0.050" (1.27 mm) and then cycle tested to failure. It should be noted that the United States Air Force damage tolerance rogue flaw is 0.050" (1.27 mm).

It was found that crack growth was significantly delayed when shot peening was included. As the following results demonstrate, at a 15 ksi (104 MPa) net stress condition the remaining life increased by 237%. At a 20 ksi (138 MPa) net stress condition the remaining life increased by 81%.

This test reflects conditions that are harsher than real world conditions. Real world conditions would generally not have initial flaws and should respond with better fatigue life improvements at these stress levels.

NON-SHOT PEENED TEST RESULTS			SHOT PEENED TEST RESULTS			
Net Stress	Number Of Tests	Average Life Cycles	Net Stress	Number Of Tests	Average Life Cycles	Percent Increase
15 ksi	2	75,017	15 ksi	2	253,142	237%
20	3	26,029	20	3	47,177	81%

Note on sample preparation: A notch was placed in the surface via the EDM process. The samples were loaded in fatigue until the crack grew to ~ 0.050" (1.27 mm). If samples were shot peened, they were peened after the initial crack of 0.050" (1.27 mm) was generated. This was the starting point for the above results. [Ref 1.1]

DEPTH OF RESIDUAL STRESS

The depth of the compressive layer is influenced by variations in peening parameters and material hardness [Ref 1.2]. **FIGURE 1-7** shows the relationship between the depth of the compressive layer and the shot peening intensity for five materials: steel 30 HRC, steel 50 HRC, steel 60 HRC, 2024 aluminum and titanium 6Al-4V. Depths for materials with other hardness values can be interpolated.

SHOT PEENING MEDIA

Media used for shot peening (also see Chapter 11) consists of small spheres of cast steel, conditioned cut wire (both carbon and stainless steel), ceramic or glass materials. Most often cast or wrought carbon steel is employed. Stainless steel media is used in applications where iron contamination on the part surface is of concern.

Carbon steel cut wire, conditioned into near round shapes, is being specified more frequently due to its uniform, wrought consistency and great durability. It is available in various grades of hardness and in much tighter size ranges than cast steel shot.

Glass beads are also used where iron contamination is of concern. They are generally smaller and lighter than other media and can be used topeen into sharp radii of threads and delicate parts where very low intensities are required.

EFFECT OF SHOT HARDNESS

It has been found that the hardness of the shot will influence the magnitude of compressive stress (**FIGURE 1-8**). The peening media should be at least as hard or harder than the parts being peened unless surface finish is a critical factor. For a large number of both ferrous and nonferrous parts, this criterion is met with regular hardness steel shot (45-52 HRC).

The increased use of high strength, high hardness steels (50 HRC and above) is reflected in the use of special hardness shot (55-62 HRC).

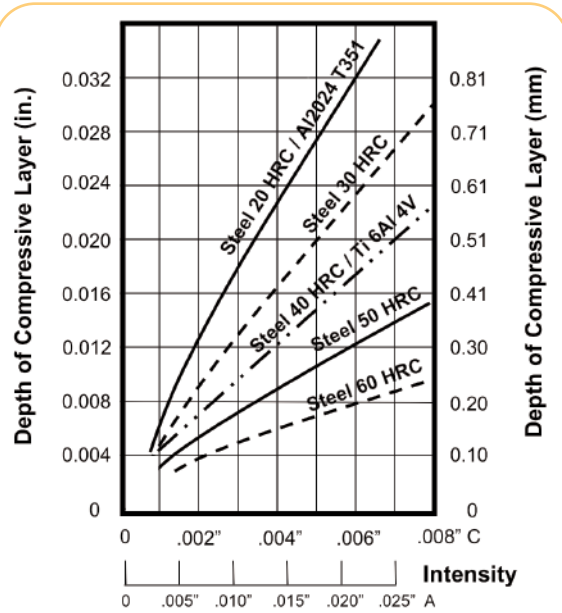

FIGURE 1-7 Depth of Compression vs. Almen Arc Height

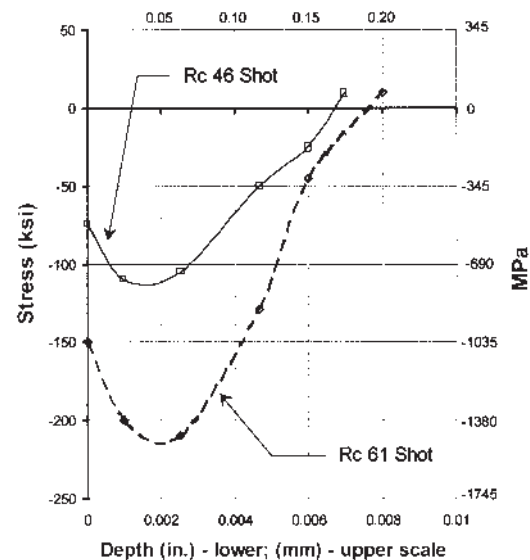

FIGURE 1-8 Peening 1045 Steel (Rc 50+) [Ref 1.3]

REFERENCES:

- 1.1 Dubberly, Everett, Matthews, Prabhakaran, Newman; *The Effects of Shot and Laser Peening on Crack Growth and Fatigue Life in 2024 Aluminum Alloy and 4340 Steel*, US Air Force Structural Integrity Conference, 2000
- 1.2 Fuchs; *Shot Peening Stress Profiles*
- 1.3 Lauchner, WESTEC Presentation March 1974, Northrup Corporation; Hawthorne, California

HIGH STRENGTH STEELS

The residual compressive stress induced by shot peening is a percentage of the ultimate tensile strength and this percentage increases as the strength/hardness increases. Higher strength/hardness metals tend to be brittle and sensitive to surface notches. These conditions can be overcome by shot peening permitting the use of high strength metals in fatigue prone applications. Aircraft landing gear are often designed to strength levels of 300 ksi (2068 MPa) that incorporate shot peening. **FIGURE 2-1** shows the relationship between shot peening and use of higher strength materials.

Without shot peening, optimal fatigue properties for machined

steel components are obtained at approximately 30 HRC. At higher strength/hardness levels, materials lose fatigue strength due to increased notch sensitivity and brittleness. With the addition of compressive stresses, fatigue strength increases proportionately to increasing strength/hardness. At 52 HRC, the fatigue strength of the shot peened specimen is 144 ksi (993 MPa), more than twice the fatigue strength of the unpeened, smooth specimen [Ref 2.1].

Typical applications that take advantage of high strength/hardness and excellent fatigue properties with shot peening are impact wrenches and percussion tools. In addition, the fatigue strength of peened parts is not impaired by shallow scratches that could otherwise be detrimental to unpeened high strength steel [Ref 2.2].

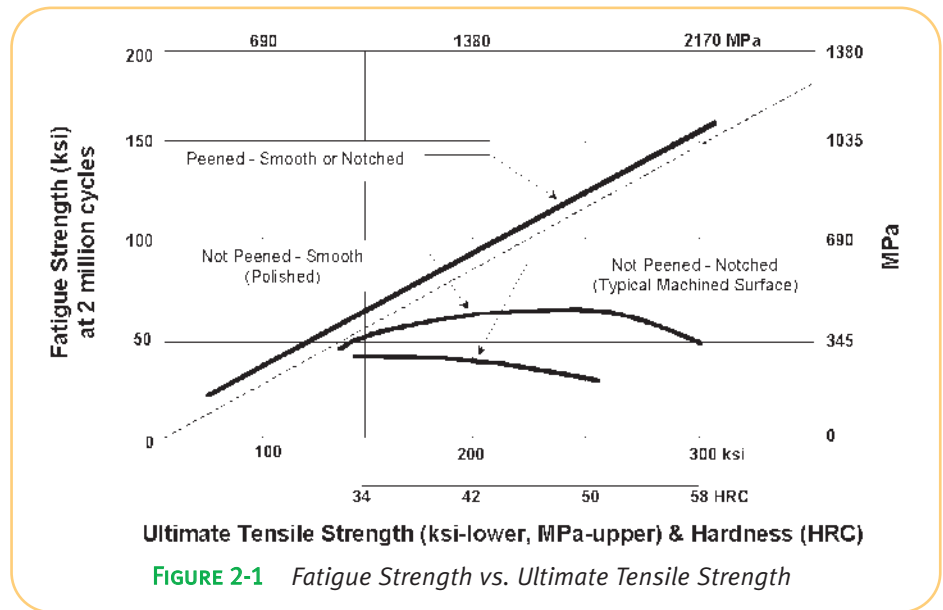

CARBURIZED STEELS

Carburizing and carbonitriding are heat treatment processes that result in very hard surfaces. They are commonly 55-62 HRC. The benefits of shot peening carburized steels are as follows:

- High magnitudes of compressive stress of ~ 200 ksi (1379 MPa) or greater offer excellent fatigue benefits
- Carburizing anomalies resulting from surface intergranular oxidation are reduced.

Shot hardness of 55-62 HRC is recommended for fully carburized and carbonitrided parts if maximum fatigue properties are desired.

APPLICATION CASE STUDY

HIGH PERFORMANCE CRANKSHAFTS

Crankshafts for 4-cylinder high performance engines were failing prematurely after a few hours running on test at peak engine loads. Testing proved that gas carburizing and shot peening the crankpins gave the best fatigue performance (FIGURE 2-2). Results from nitriding and shot peening also demonstrated favorable results over the alternative to increase the crankpin diameter [Ref 2.3].

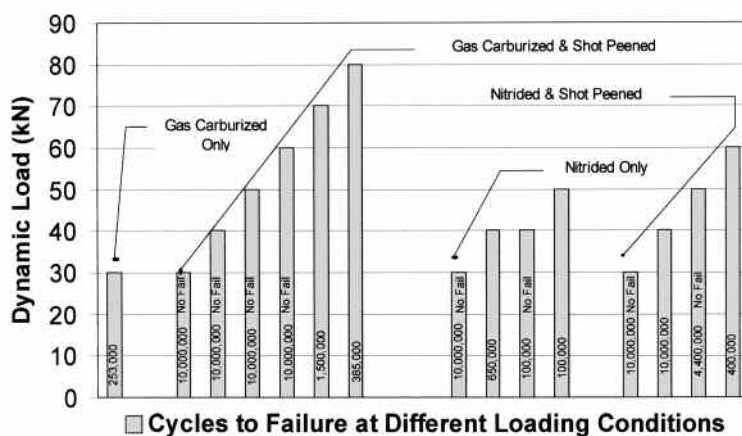

FIGURE 2-2 Comparison of Shot Peened Nitrided and Gas Carburized Crank Pins

DECARBURIZATION

Decarburization is the reduction in surface carbon content of a ferrous alloy during thermal processing. It has been shown that decarburization can reduce the fatigue strength of high strength steels (240 ksi, 1650 MPa or above) by 70-80% and lower strength steels (140-150 ksi, 965-1030 MPa) by 45-55% [Refs 2.4, 2.5 and 2.6].

Decarburization is a surface phenomenon not particularly related to depth. A depth of 0.003 inch decarburization can be as detrimental to fatigue strength as a depth of 0.030 inch [Refs 2.4, 2.5 and 2.6].

Shot peening has proven to be effective in restoring most of the fatigue strength lost due to decarburization [Ref 2.7]. Because the decarburized layer is not easily detectable on quantities of parts, peening can insure the integrity of the parts if decarburization is suspected. If a gear that is intended to have a high surface hardness (58+ HRC) exhibits unusually heavy dimpling after peening, decarburization should be suspected.

Decarburization is often accompanied with the undesirable metallurgical condition of retained austenite. By cold working the surface, shot peening reduces the percentage of retained austenite.

APPLICATION CASE STUDY

REDUCTION OF RETAINED AUSTENITE - 5120 CARBURIZED STEEL, SHOT PEENED AT 0.014" (0.36 mm) A INTENSITY

Depth (inches)	Depth (mm)	Retained Austenite (Volume %)	
		Unpeened	Peened
0.0000	0.00	5	3
0.0004	0.01	7	4
0.0008	0.02	14	5
0.0012	0.03	13	6
0.0016	0.04	14	7
0.0020	0.05	14	7
0.0024	0.06	15	8
0.0028	0.07	15	9
0.0039	0.10	15	10
0.0055	0.14	12	10

[Ref 2.8]

AUSTEMPERED DUCTILE IRON

Improvements in austempered ductile iron (ADI) have allowed it to replace steel forgings, castings, and weldments in some engineering applications. ADI has a high strength-to-weight ratio and the benefit of excellent wear capabilities. ADI has also replaced aluminum in certain high strength applications as it is at least 3 times stronger and only 2.5 times more dense. With the addition of shot peening, the allowable bending fatigue strength of ADI can be increased up to 75%. This makes certain grades of ADI with shot peening comparable to case-carburized steels for gearing applications [Ref 2.9].

CAST IRON

There has been an increased demand in recent years for nodular cast iron components that are capable of withstanding relatively high fatigue loading. Cast iron components are often used without machining in applications where the cast surface is subject to load stresses. The presence of imperfections at casting surfaces in the form of pinholes, dross or flake graphite can considerably reduce the fatigue properties of unmachined pearlitic nodular irons. The unnotched fatigue limit may be reduced by as much as 40%, depending on the severity of the imperfections at the casting surface.

Shot peening can significantly improve properties when small cast-surface imperfections are present. One application is diesel engine cylinder liners. At the highest shot peening intensity used in the tests, the fatigue limit was 6% below that of fully machined fatigue specimens. This compares to a reduction of 20% for specimens in the as-cast unpeened condition. Visually, the peening on the as-cast surface has a polishing effect leaving the appearance of smoothing the rougher as-cast surface [Ref 2.10].

ALUMINUM ALLOYS

Traditional high strength aluminum alloys (series 2000 and 7000) have been used for decades in the aircraft industry because of their high strength-to-weight ratio. The following aluminum alloys have emerged with increasing use in critical aircraft/aerospace applications and respond equally well to shot peening:

- Aluminum Lithium Alloys (Al-Li)
- Isotropic Metal Matrix Composites (MMC)
- Cast Aluminum (Al-Si)

APPLICATION CASE STUDY

Al 7050-T7651 HIGH STRENGTH ALUMINUM

Fatigue specimens were prepared from high strength Al 7050-T7651. All four sides of the center test portion were shot peened. Fatigue tests were conducted under a four-point reversed bending mode ($R = -1$). The S-N curve of the shot peened versus non-shot peened alloy is shown in **FIGURE 2-3**. It was found that shot peening improved the fatigue endurance limit by approximately 33%. Even in a regime where the stress ratio is between the yield strength and the endurance limit, the fatigue strength increased by a factor of 2.5 to almost 4 [Ref 2.11].

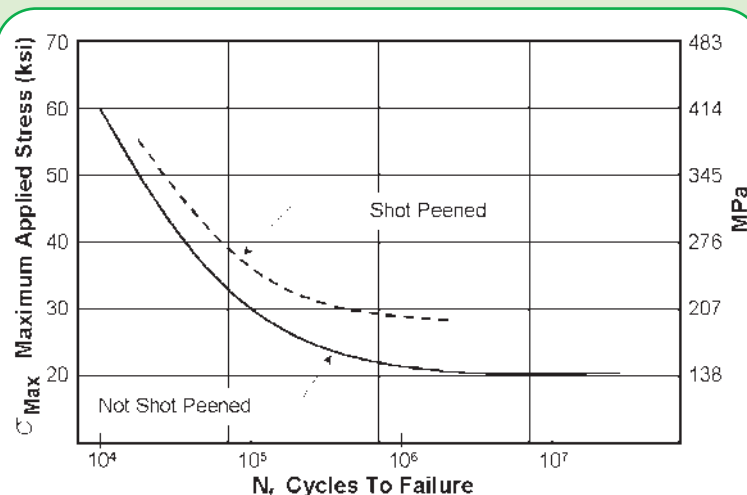

FIGURE 2-3 S-N Curves for Shot Peened Aluminum Alloy 7050-T7651

TITANIUM

High Cycle Fatigue (HCF) - HCF of titanium is illustrated by **FIGURE 2-4**, which compares the capabilities of titanium alloy connecting rods for a high performance European sports car. The rods are manufactured using various processes. With shot peening, the fatigue limit was increased by approximately 20% while weight was reduced by some 40% as compared to steel connecting rods [Ref 2.12].

Low Cycle Fatigue (LCF) - As is typical with other metals, the fatigue response with shot peening increases with higher cycle fatigue. Higher cycle fatigue would be associated with lower stresses whereas lower cycle fatigue would be associated with higher stress levels. This is demonstrated graphically in the S-N Curve (**FIGURE 1-4**) and also **FIGURE 2-5**.

FIGURE 2-5 shows the results of shot peening titanium dovetail slots on a rotating engine component [Ref 2.13]. There are two baseline load curves that are not shot peened. When shot peening is applied, the base line curve that initially had more cycles to failure responded significantly better. Note that improvements in fatigue life are on an exponential basis.

The most common application of LCF for titanium is the rotating turbine engine hardware (discs, spools, and shafts) with the exception of blades. These components are shot peened to increase durability. Each takeoff and landing is considered one load cycle.

Comparison Of Fatigue Strengths For Polished and Shot Peened Titanium Ti 6Al4V Connecting Rods

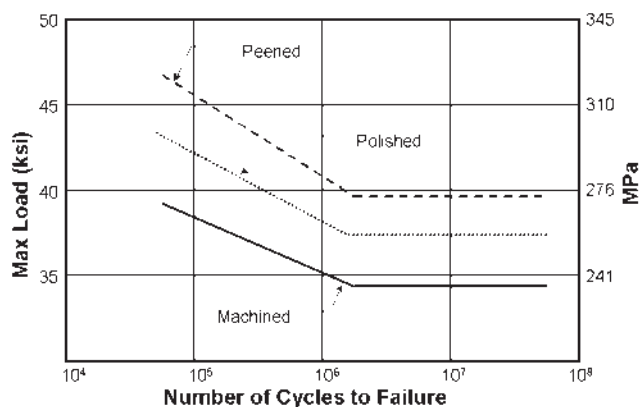

FIGURE 2-4 Comparison of Fatigue Strengths for Polished and Shot Peened Titanium Ti6Al4V

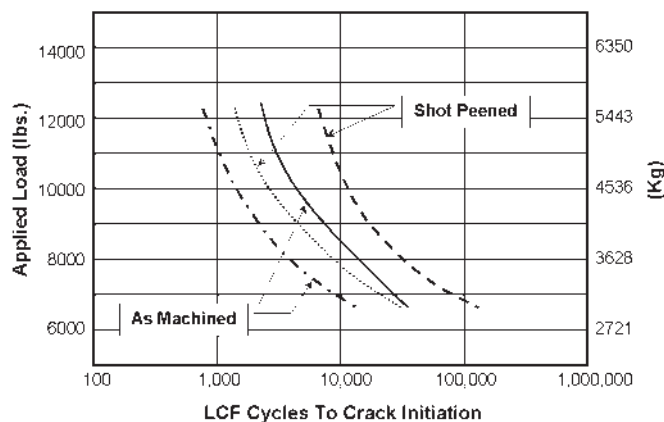

FIGURE 2-5 LCF Benefits from Shot Peening Notched Ti8-1-1

MAGNESIUM

Magnesium alloys are not commonly used in fatigue applications. However, when used for the benefit of weight reduction, special peening techniques can be employed to achieve 25 - 35% improvement in fatigue strength.

POWDER METALLURGY

Optimized peening parameters have been shown to raise the endurance limit of sintered steel PM alloys by 22% and the fatigue life by a factor of 10. [Ref. 2.14] Automotive components such as gears and connecting rods are candidates for PM with shot peening. Shot peening is most effective on higher density PM parts such as forged powder metal components.

Surface densification by shot peening can increase the fatigue limit significantly, especially in the case of bending. The surface densification also assists in the closing of surface porosity of PM components for sealing and other engineering applications.

APPLICATION CASE STUDY

HIGH DENSITY POWDER METAL GEARS

Tooth root bending fatigue studies were performed using pulsator tests to compare a reference wrought gear steel to a 7.5 g/cm³ powdered metal gear. Both gears were 3.5 mm module consisting of 25 teeth and case hardened to 60 HRC. The wrought gear was a 16MnCr5 steel and the powdered metal gear was Fe-3.5Mo alloy content.

In **FIGURE 2-6** the powdered metal gear results are depicted with the blue curves. The endurance limit improved ~ 35% with the addition of shot peening. The endurance limit improved from ~ 95 ksi (650 MPa) to ~ 128 ksi (880 MPa). The endurance limit of the shot peened powdered metal compares very closely with the non-peened 16MnCr5 material. Due to the significant cost savings of powdered metal, the shot peened powder metal gear may be a suitable replacement to the more expensive wrought steel gear. Shot peening was performed at 0.013" A (0.32 mm A) intensity for all samples [Ref 2.15].

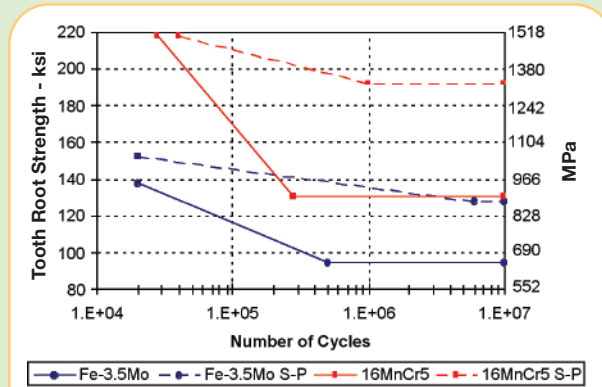

FIGURE 2-6 Fatigue Life Curves Comparing a Reference (16MnCr5) Wrought Steel to a 7.5 g/cm³ Powdered Metal (Fe-3.5Mo) with and without Shot Peening.

Pressed and sintered ferrous powder materials are in increasing demand as the PM industry has grown into applications involving more highly stressed components. Ancorsteel 1000B with 2% copper and 0.9% graphite had an endurance limit of 35 ksi (240 MPa) when tested without shot peening. Shot peening the test specimens increased the endurance limit 16% to 40.5 ksi (280 MPa) [Ref 2.16].

REFERENCES:

- 2.1 Horger; *Mechanical and Metallurgical Advantages of Shot Peening – Iron Age Reprint 1945*
- 2.2 Hatano and Namitki; *Application of Hard Shot Peening to Automotive Transmission Gears, Special Steel Research Laboratory, Daido Steel Company, Ltd., Japan*
- 2.3 Challenger; *Comparison of Fatigue Performance Between Engine Crank Pins of Different Steel Types and Surface Treatments, Lucas Research Center, Solihull, England, July 1986*
- 2.4 *Properties and Selection, Metals Handbook, Eighth Edition, Vol. 1, pp. 223-224*
- 2.5 Jackson and Pochapsky; *The Effect of Composition on the Fatigue Strength of Decarburized Steel, Translations of the ASM, Vol. 39, pp. 45-60*
- 2.6 Bush; *Fatigue Test to Evaluate Effects of Shot Peening on High Heat Treat Steel - Lockheed Report No. 9761*
- 2.7 Gassner; *Decarburization and Its Evaluation by Chord Method, Metal Progress, March 1978, pp. 59-63*
- 2.8 *Internal Metal Improvement Company Memo*
- 2.9 Keough, Brandenburg, Hayrynen; *Austempered Gears and Shafts: Tough Solutions, Gear Technology March/April 2001, pp. 43-44*
- 2.10 Palmer; *The Effects of Shot Peening on the Fatigue Properties of Unmachined Pearlitic Nodular Graphite Iron Specimens Containing Small Cast Surface Imperfections, BCIRA Report #1658, The Casting Development Centre, Alvechurch, Birmingham, UK*
- 2.11 Oshida and Daly; *Fatigue Damage Evaluation of Shot Peened High Strength Aluminum Alloy, Dept. of Mechanical and Aerospace Engineering, Syracuse University, Syracuse, NY*
- 2.12 *Technical Review, Progress in the Application of Shot-Peening Technology for Automotive Engine Components, Yamaha Motor Co., Ltd., 1998*
- 2.13 McGann and Smith; *Notch Low Cycle Fatigue Benefits from Shot Peening of Turbine Disk Slots*
- 2.14 Sونسino, Schlieper, Muppmann; *How to Improve the Fatigue Properties of Sintered Steels by Combined Mechanical and Thermal Surface Treatments, Modern Developments in Powder Metallurgy, Volume 15 - 17, 1985*
- 2.15 Strehl, R., 2001, "Load Capacity of Gears Made From High Strength Powder Metal Steel," *Doctorate Thesis Study, University of Aachen, Germany*
- 2.16 O'Brian; *Impact and Fatigue Characterization of Selected Ferrous P/M Materials, Annual Powder Metallurgy Conference, Dallas, TX. May 1987*

EFFECT ON FATIGUE LIFE

Manufacturing processes have significant effects on fatigue properties of metal parts. The effects can be either detrimental or beneficial. Detrimental processes include welding, grinding, abusive machining, metal forming, etc. These processes leave the surface in residual tension. The summation of residual tensile stress and applied loading stress accelerates fatigue failure as shown in **FIGURE 1-6**.

Beneficial manufacturing processes include surface hardening as it induces some residual compressive stress into the surface. Honing, polishing and burnishing are surface enhancing processes that remove defects and stress raisers from manufacturing operations. Surface rolling induces compressive stress but is primarily limited to cylindrical geometries. Shot peening has no geometry limitations and produces results that are usually the most economical.

The effect of residual stress on fatigue life is demonstrated in the following example. A test by an airframe manufacturer on a wing fitting showed the initiation of a crack at just 60% of predicted life. The flaw was removed and the same area of the part shot peened. The fitting was then fatigue tested to over 300% life without further cracking even with reduced cross sectional thickness [Ref 3.1].

WELDING

The residual tensile stress from welding is created because the weld consumable is applied in its molten state. This is its hottest, most expanded state. It then bonds to the base material, which is much cooler. The weld cools rapidly and attempts to shrink during the cooling. Because it has already bonded to the cooler, stronger base material it is unable to shrink. The net result is a weld that is essentially being "stretched" by the base material. The heat affected zone is usually most affected by the residual stress and hence where failure will usually occur. Inconsistency in the weld filler material, chemistry, weld geometry, porosity, etc., act as stress risers for residual and applied tensile stress to initiate fatigue failure.

As shown in **FIGURE 3-1**, shot peening is extremely beneficial in reversing the residual stress from welding that tends to cause failure in the heat affected zone from a tensile to a compressive state.

FIGURE 3-1 demonstrates a number of interesting changes in residual stress from welding, thermal stress relieving and shot peening [Ref 3.2]. Tensile stresses generated from welding are additive with applied load stresses. This combined stress will accelerate failure at welded connections.

When the weld is stress relieved at 1150 °F (620 °C) for one hour, the tensile stress is reduced to almost zero. This reduction of tensile stress will result in improved fatigue properties.

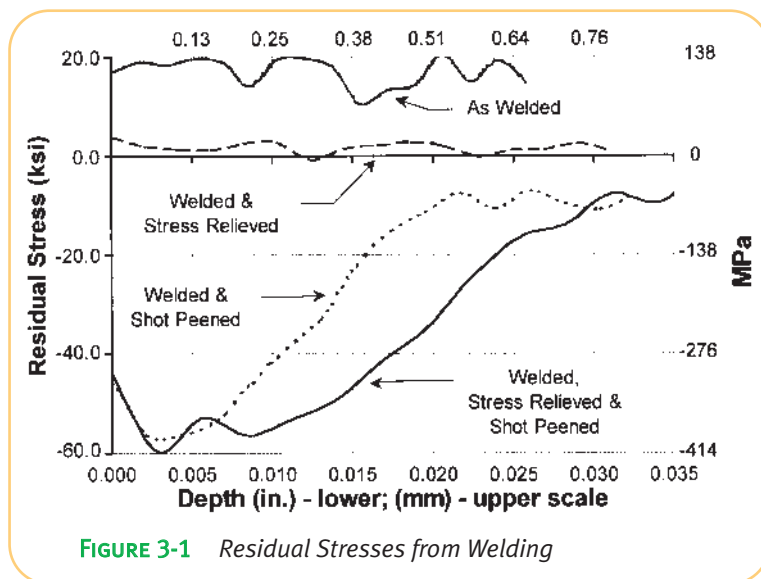

If the weld is shot peened (rather than stress relieved) there is a significant reversal of residual stress from tensile to compressive. This will offer significant resistance to fatigue crack initiation and propagation.

FIGURE 3-1 shows the optimal manufacturing sequence for welding is to stress relieve and then shot peen. The stress relieving process softens the weld such that inducing a deeper layer of compressive stress becomes possible.

APPLICATION CASE STUDY

FATIGUE OF OFFSHORE STEEL STRUCTURES

A Norwegian research program concluded that the combination of weld toe grinding and shot peening gave the largest improvement in the structure life. This corresponds to more than a 100% increase in the as-welded strength at one million cycles [Ref 3.3]. Other research shows that the improvement in weld fatigue strength from shot peening increases in proportion to the yield strength of the parent metal.

<i>Steel Condition</i>	<i>Fatigue Strength At 1,000,000 Cycles</i>
Base Material	~ 50 ksi (340 MPa)
Weld Toe Ground and Peened	~ 44 ksi (300 MPa)
Weld Toe Ground (only)	~ 26 ksi (180MPa)
As Welded (only)	~ 20 ksi (140MPa)

The American Welding Society (AWS) Handbook cautions readers to consider residual tensile stresses from welding if the fabrication is subject to fatigue loading as described in the following statement: "Localized stresses within a structure may result entirely from external loading, or there may be a combination of applied and residual stresses. Residual stresses are not cyclic, but they may augment or detract from applied stresses depending on their respective sign. For this reason, it may be advantageous to induce compressive residual stress in critical areas of the weldment where cyclic applied stresses are expected".

The use of the shot peening process to improve resistance to fatigue as well as stress corrosion cracking in welded components is recognized by such organizations as:

- o American Society of Mechanical Engineers [Ref. 3.4]
- o American Bureau of Shipping [Ref. 3.5]
- o American Petroleum Institute [Ref. 3.6]
- o National Association of Corrosion Engineers [Ref. 3.7]

APPLICATION CASE STUDY

TURBINE ENGINE HP COMPRESSOR ROTORS

Two leading companies in the manufacture of jet turbine engines jointly manufacture high pressure compressor rotors. Separate pieces are machined from forged titanium (Ti 4Al-6V) and then welded together. Testing produced the following results:

As Welded	4,000 cycles*
Welded and polished	6,000 cycles
Welded and peened	16,000 cycles

* In aircraft engine terminology one cycle equals the ramp up required for one take-off of the aircraft for which the engine is configured.

Initially, shot peening was used as additional "insurance" from failure. After many years of failure free service, coupled with innovations in shot peening controls, shot peening has been incorporated as a full manufacturing process in engine upgrades [Ref 3.8].

GRINDING

Typically, grinding induces residual tensile stress as a result of localized heat generated during the process. The metal in contact with the abrasive medium heats locally and attempts to expand. The heated material is weaker than the surrounding metal and yields in compression. Upon cooling the yielded metal attempts to contract. This contraction is resisted by the surrounding metal resulting in residual tensile stress. Residual tensile stress of any magnitude will have a negative effect on fatigue life and resistance to stress corrosion cracking.

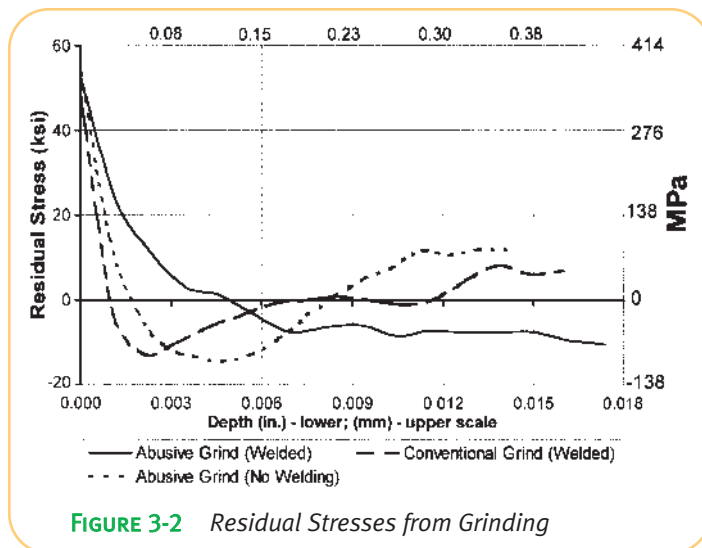

FIGURE 3-2 Residual Stresses from Grinding

FIGURE 3-2 graphically depicts residual tensile stress generated from various grinding processes [Ref 3.9]. A 1020, 150-180 BHN carbon steel (with and without weld) was ground abusively and conventionally. FIGURE 3-2 shows that the grinding processes resulted in high surface tension with the abusive grind having a deeper (detrimental) layer of residual tension.

Shot peening after grinding will reverse the residual stress state from tensile to compressive. The beneficial stress reversal is similar to that from shot peening welded regions in a state of tension.

PLATING

Many parts are shot peened prior to chrome and electroless nickel plating to counteract the potential harmful effects on fatigue life. Fatigue deficits from plating may occur from the micro-cracking in the brittle surface, hydrogen embrittlement or residual tensile stresses.

FIGURE 3-3 is a 1200x SEM photograph showing a network of very fine cracks that is typical of hard chrome plating [Ref 3.10]. Under fatigue loading, the micro-cracks can propagate into the base metal and lead to fatigue failure.

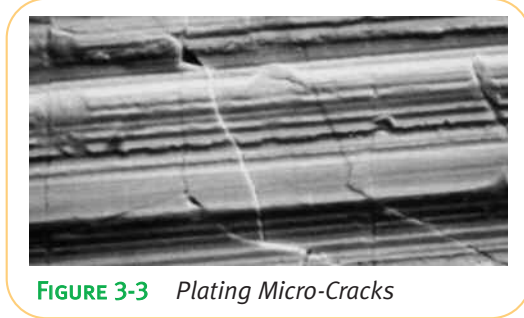

FIGURE 3-3 Plating Micro-Cracks

When the base metal is shot peened, the potential for fatigue crack propagation into the base metal from the plating is dramatically reduced. FIGURE 3-4 illustrates this concept and assumes dynamic loading on a component.

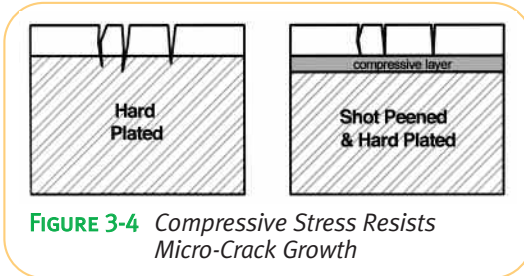

FIGURE 3-4 Compressive Stress Resists Micro-Crack Growth

The graphic on the left shows the micro-cracking propagating into the base material. When shot peened, the graphic on the right shows the compressive layer preventing the micro-cracking from propagating into the base material.

Shot peening prior to plating is recommended on cyclically loaded parts to enhance fatigue properties. For parts that require unlimited life under dynamic loads, federal specifications QQ-C-320 and MIL-C-26074 call for shot peening of steel parts prior to chrome or electroless nickel-plating. Other hard plating processes such as electrolytic nickel may also lower fatigue strength.

ANODIZING

Hard anodizing is another application in which shot peening improves fatigue resistance of coated materials. Benefits are similar to those for plating providing the peening is performed to the base material before anodizing.

APPLICATION CASE STUDY

ANODIZED ALUMINUM RINGS

Aluminum (AlZnMgCu 0.5) rings with external teeth were tested for comparison purposes with anodizing and shot peening. The rings had an outside diameter of ~ 24" (612 mm) and a tensile strength of ~ 71 ksi (490 MPa). The (hard) anodizing layer was ~ 0.0008" (0.02 mm) thick.

Bending fatigue tests were conducted to find the load to cause a 10% failure probability at one million cycles. The table shows the results [Ref 3.11].

<i>Shot Peened</i>	<i>Hard Anodized</i>	<i>Load (10% Failure)</i>
No	No	6744 lb / 30 KN
Yes	No	9218 lb / 41 KN
No	Yes	4496 lb / 20 KN
Yes	Yes	10,791 lb / 48 KN

PLASMA SPRAY

Plasma spray coatings are primarily used in applications that require excellent wear resistance. Shot peening has proven effective as a base material preparation prior to plasma spray applications that are used in cyclic fatigue applications. Shot peening has also been used after the plasma spray application to improve surface finish and close surface porosity.

ELECTRO-DISCHARGE MACHINING (EDM)

EDM is essentially a "force-free" spark erosion process. The heat generated to discharge molten metal results in a solidified recast layer on the base material. This layer can be brittle and exhibit tensile stresses similar to those generated during the welding process. Shot peening is beneficial in restoring the fatigue debits created by this process. In **FIGURE 3-5** the effect of shot peening on electro-chemical machined (ECM), electro-discharge machined (EDM) and electro-polished (ELP) surfaces is shown [Ref 3.12]. **FIGURE 3-5** should be viewed in a clockwise format. ECM, EDM and ELP fatigue strengths are compared with and without shot peening.

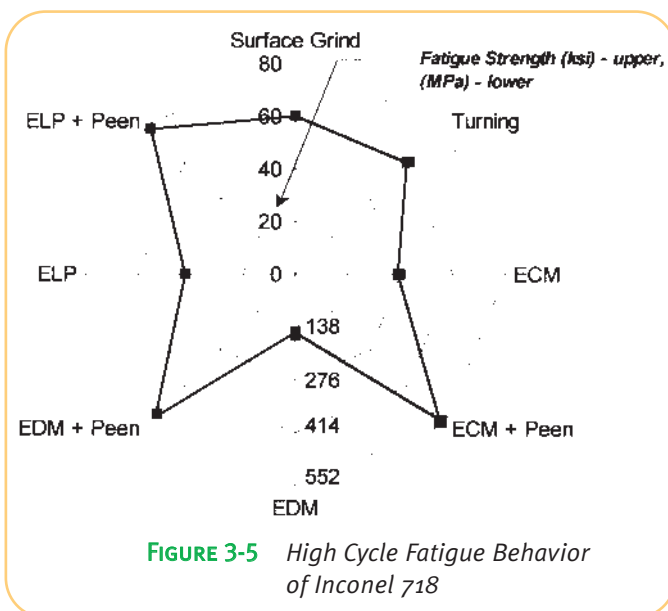

ELECTRO-CHEMICAL MACHINING (ECM)

Electro-chemical machining is the controlled dissolution of material by contact with a strong chemical reagent in the presence of an electric current. A reduction in fatigue properties is attributed to surface softening (the rebinder effect) and surface imperfections left by preferential attack on grain boundaries. A shot peening post treatment more than restores fatigue properties as shown in **FIGURE 3-5** [Ref 3.12].

APPLICATION CASE STUDY

DIAPHRAGM COUPLINGS

Metal diaphragm couplings are often used in turbomachinery applications. These couplings accommodate system misalignment through flexing. This flexing, or cyclic loading, poses concerns for fatigue failures. Researchers concluded that the ECM process produces parts that are geometrically near-perfect. However, they found under scanning electron microscope observation that small cavities sometimes developed on the surface as a result of ECM. These cavities apparently generated stress concentrations that lead to premature failures. Shot peening after ECM was able to overcome this deficiency and has significantly improved the endurance limit of the diaphragm couplings [Ref 3.13 and 3.14].

REFERENCES:

- 3.1 Internal Metal Improvement Company Memo
- 3.2 Molzen, Hornbach; *Evaluation of Welding Residual Stress Levels Through Shot Peening and Heat Treating*, AWS Basic Cracking Conference; Milwaukee, WI; July 2000
- 3.3 Haagensen; *Prediction of the Improvement in Fatigue Life of Welded Joints Due to Grinding, TIG Dressing, Weld Shape Control and Shot peening.* The Norwegian Institute of Technology, Trondheim, Norway
- 3.4 McCulloch; *American Society of Mechanical Engineers*, Letter to H. Kolin, May 1975
- 3.5 Stern; *American Bureau of Shipping*, Letter to G. Nachman, July 1983
- 3.6 Ubben; *American Petroleum Institute*, Letter to G. Nachman, February 1967
- 3.7 N.A.C.E Standard MR-01-75, *Sulfide Stress Cracking Resistant Metallic Material for Oilfield Equipment*, National Association of Corrosion Engineers
- 3.8 Internal Metal Improvement Company Memo
- 3.9 Molzen, Hornbach; *Evaluation of Welding Residual Stress Levels Through Shot Peening and Heat Treating*, AWS Basic Cracking Conference; Milwaukee, WI; July 2000
- 3.10 Metallurgical Associates, Inc; "Minutes" Vol.5 No.1, Winter 1999; Milwaukee, WI
- 3.11 Internal Metal Improvement Company Memo
- 3.12 Koster, W.P., *Observation on Surface Residual Stress vs. Fatigue Strength*, Metcut Research Associates, Inc., Cincinnati, Ohio. Bulletin 677-1, June 1977
- 3.13 Calistrat; *Metal Diaphragm Coupling Performance*, Hydrocarbon Processing, March 1977
- 3.14 Calistrat; *Metal Diaphragm Coupling Performance*, 5th Turbomachinery Symposium, Texas A&M University, October 1976

BENDING FATIGUE

Bending fatigue is the most common fatigue failure mode. This failure mode responds well to shot peening because the highest (tensile) stress is at the surface.

FIGURE 4-1 shows a cantilever beam under an applied bending load. The beam's deflection causes the top surface to stretch putting it in a state of tension. Any radii or geometry changes along the top surface would act as stress risers.

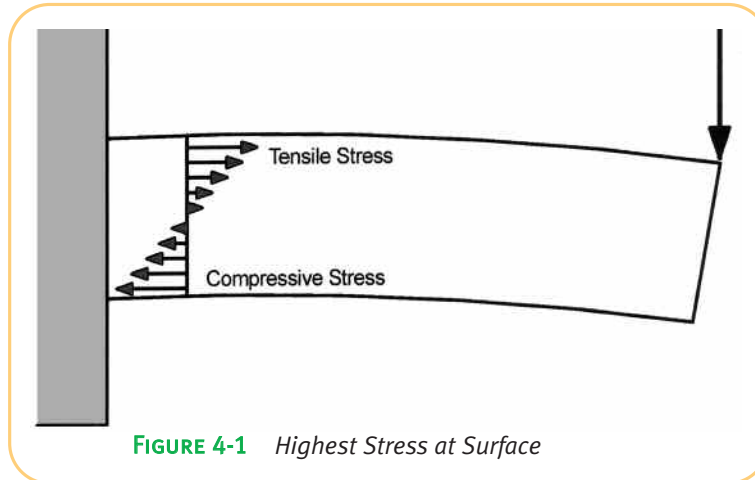

FIGURE 4-1 Highest Stress at Surface

Fully reversed bending involves components that cycle through tensile and compressive load cycles. This is the most destructive type of fatigue loading. Fatigue cracks are initiated and propagated from the tensile portion of the load cycle.

GEARS

Shot peening of gears is a very common application. Gears of any size or design are mainly shot peened to improve bending fatigue properties in the root sections of the tooth profile. The meshing of gear teeth is similar to the cantilever beam example. The load created from the tooth contact creates a bending stress in the root area below the point of contact (**FIGURE 4-3**).

Gears are frequently shot peened after through hardening or surface hardening. Increased surface hardness results in proportional increases in compressive stress. Maximum residual compression from carburized and shot peened gears can range from 170-230 ksi (1170-1600 MPa) depending on the carburizing treatment and shot peening parameters (**FIGURE 4-4**). It is common to use hard shot (55-62 HRC) when shot peening carburized gears. However, reduced hardness shot (45-52 HRC) may be used when carburized surfaces require less disruption of the tooth flank surface. The amount of compressive stress will be ~ 50% of that which hard shot will induce.



FIGURE 4-2 Ring and Pinion Gear Assembly



FIGURE 4-3 Polarized View of Applied Gear Stresses

The optimal way to induce resistance to pitting fatigue near the gear tooth pitch line is to induce a compressive stress followed by a lapping, honing or isotropic finishing process. Care must be taken to not remove more than 10% of the shot peening layer. Processes that refine the surface finish of shot peening dimples allow the contact load to be distributed over a larger surface area reducing contact stresses.

Metal Improvement Company (MIC) offers a shot peening and superfinishing process called C.A.S.E.SM that has increased pitting fatigue resistance of gears by 500%. Please see Chapter 10 for additional information and photomicrographs on this process.

Increases in fatigue strength of 30% or more at 1,000,000 cycles are common in certain gearing applications. The following organizations/specifications allow for increases in tooth bending loads when controlled shot peening is implemented:

- Lloyds Register of Shipping: 20% increase [Ref 4.2]
- Det Norske Veritas: 20% increase [Ref 4.3]
- ANSI/AGMA 6032-A94 Marine Gearing Specification: 15% increase

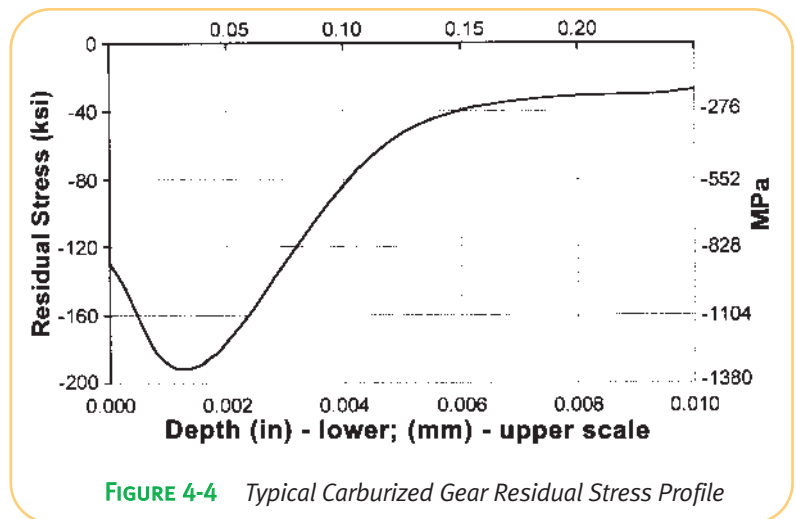

FIGURE 4-4 Typical Carburized Gear Residual Stress Profile

CONNECTING RODS

Connecting rods are excellent examples of metal components subjected to fatigue loading as each engine revolution results in a load cycle. The critical failure areas on most connecting rods are the radii on either side of the I-beams next to the large bore. FIGURE 4-5 shows a finite element stress analysis plot with the maximum stress areas shown in red.

The most economical method of shot peening is to peen the as-forged, as-cast or powdered metal rod prior to any machining of the bores or faces. This eliminates masking operations that will add cost. Rougher surfaces in compression have better fatigue properties than smooth surfaces in tension (or without residual stress) such that most peened surfaces do not require prior preparation or post operations.

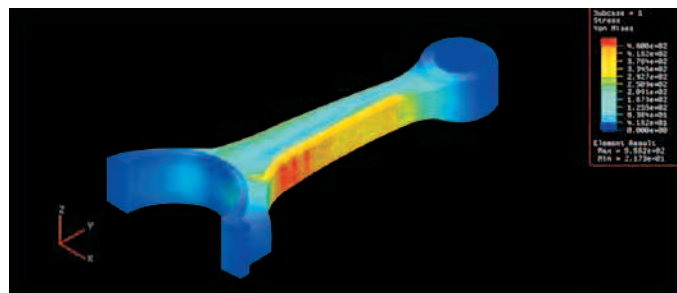

FIGURE 4-5 Finite Element Stress Plot of a Connecting Rod

CRANKSHAFTS

In most cases, all radii on a crankshaft are shot peened. These include the main bearing journals and crankpin radii as shown in **FIGURE 4-6**. The most highly stressed area of a crankshaft is the crank pin bearing fillet. The maximum stress area is the bottom side of the pin fillet when the engine fires as the pin is in the top dead center position (**FIGURE 4-6**). It is common for fatigue cracks to initiate in this pin fillet and propagate through the web of the crankshaft to the adjacent main bearing fillet causing catastrophic failure.

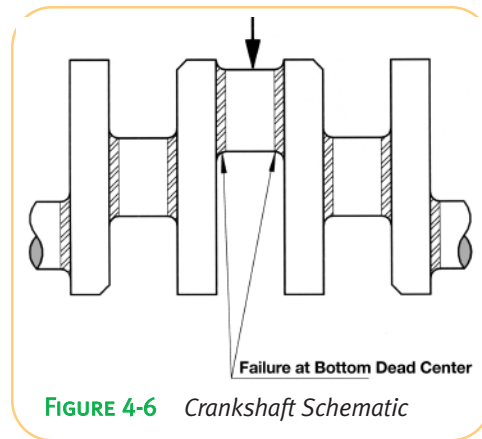

FIGURE 4-6 Crankshaft Schematic

Experience has shown shot peening to be effective on forged steel, cast steel, nodular iron, and austempered ductile iron crankshafts. Fatigue strength increases of 10 to 30% are allowed by Norway's Det Norske Veritas providing fillets are shot peened under controlled conditions [Ref 4.5].

APPLICATION CASE STUDY

DIESEL ENGINE CRANKSHAFTS

Four point bending fatigue tests were carried out on test pieces from a diesel engine crankshaft. The material was Armco 17-10 Ph stainless steel. The required service of this crankshaft had to exceed one hundred million cycles. Fatigue strength of unpeened and shot peened test pieces were measured at one billion cycles. The fatigue strength for the unpeened material was 43 ksi (293 MPa) versus 56 ksi (386 MPa) for the peened material. This is an increase of ~ 30% [Ref 4.6].

APPLICATION CASE STUDY

TURBINE ENGINE DISKS

In 1991 the Federal Aviation Authority issued an airworthiness directive that required inspection for cracks in the low pressure fan disk. Over 5,000 engines were in use on business jets in the United States and Europe.

The FAA required that engines that did not have lance (shot) peening following machining in the fan blade dovetail slot be inspected. Those engines having fan disks without lance peening were required to reduce service life from 10,000 to 4,100 cycles (takeoffs and landings). Disks that were reworked with lance peening per AMS 2432 (Computer Monitored Shot Peening) prior to 4,100 cycles were granted a 3,000 cycle extension [Ref 4.7]. A typical lance peening operation of a fan disk is shown in **FIGURE 4-7**. See also Chapter 10 – Internal Surfaces and Bores.

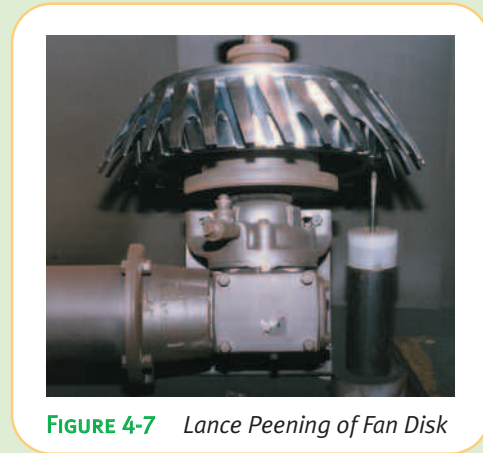

FIGURE 4-7 Lance Peening of Fan Disk

REFERENCES:

- 4.1 Figure 4-2, Unigraphics Solutions, Inc. website (www.ugsolutions.com/www.solid-edge.com), June 2000
- 4.2 Letter to W.C. Classon, Lloyds Register of Shipping, May 1990
- 4.3 Sandberg; Letter to Metal improvement Company, Det Norske Veritas, September 1983
- 4.4 Figure 4-5, Unigraphics Solutions, Inc. website (www.ugsolutions.com/www.solid-edge.com), June 2000
- 4.5 Sandberg; Letter to Metal improvement Company, Det Norske Veritas, September 1983
- 4.6 Internal Metal Improvement Company Memo
- 4.7 FAA Issues AD on TFE73, Aviation week & Space Technology; April 22, 1991

TORSIONAL FATIGUE

Torsional fatigue is a failure mode that responds well to shot peening because the greatest (tensile) stress occurs at the surface. Torsional loading creates stresses in both the longitudinal and perpendicular directions such that the maximum tensile stress is 45° to longitudinal axis of the component.

FIGURE 5-1 depicts a solid bar loaded in pure torsion with a crack depicting reversed torsional loading.

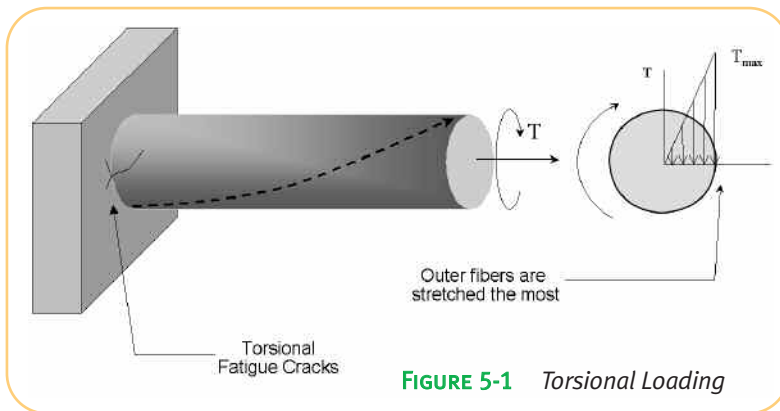

Lower strength materials tend to fail from torsional fatigue in the shear plane perpendicular to the longitudinal axis. This is because they are weaker in shear than in tension. Higher strength materials tend to fail at 45° to the longitudinal axis because they are weaker in tension than in shear.

COMPRESSION SPRINGS

Compression springs are subject to high cycle fatigue and are one of the more common shot peening applications. The spring wire twists allowing the spring to compress creating a torsional stress. In addition to operating in high cycle fatigue conditions, the coiling process induces detrimental tensile stress at the inner diameter (ID) of the spring. **FIGURE 5-3** demonstrates the residual stress after coiling and shot peening.

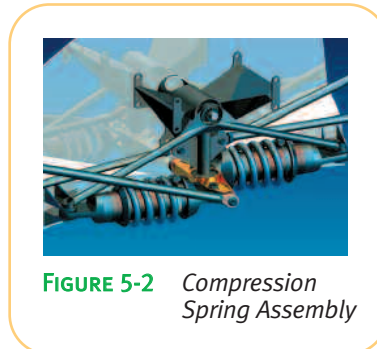

The spring wire analyzed in **FIGURE 5-3** was a 0.25" (6.35 mm) diameter Chrome-Silicon material with an ultimate tensile strength (UTS) of 260 ksi (1793 MPa). The residual tensile stress at the ID after coiling was ~ 70 ksi (483 MPa) and is the primary reason for failure at 80,000 load cycles [Ref 5.2].

Shot peening induced a reversal of residual stress to a maximum compressive stress of ~ 150 ksi (1035 MPa). This is 60% of UTS of the wire and resulted in fatigue life in excess of 500,000 load cycles without failure.

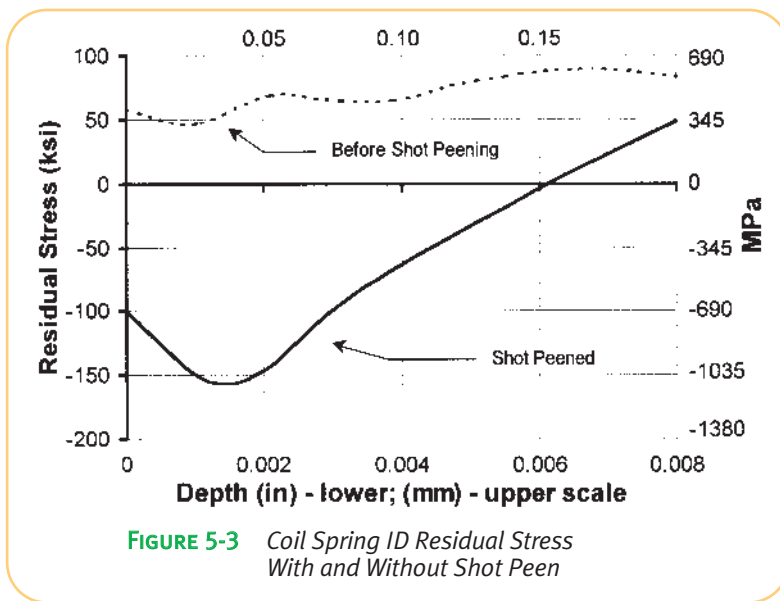

It is quite common to perform a baking operation after shot peening of springs. The baking operation is used as a stabilizing process in the manufacture of springs and is used to offset a potential setting problem that may occur with some shot peened spring designs. The baking is approximately 400 °F (205 °C) for 30 minutes for carbon steel springs and is below the stress relief temperature of the wire. Temperatures above 450 °F (230 °C) will begin to relieve the beneficial residual stress from shot peening.

Other spring designs respond equally well to shot peening. The fatigue failure will occur at the location of the highest combination of residual and applied tensile stress. Torsion springs will generally fail at the OD near the tangent of the tang. Extension springs will generally fail at the inner radius of the hook. Other potential spring designs that can benefit from shot peening are leaf springs, cantilever springs, flat springs, etc.

DRIVE SHAFTS

Shaft applications are used to transmit power from one location to another through the use of rotation. This creates a torsional load on the rotating member. Because most drive shafts are primary load bearing members, they make excellent shot peening applications. As shown in **FIGURE 5-4** typical failure locations for drive shafts are splines, undercuts, radii and keyways.

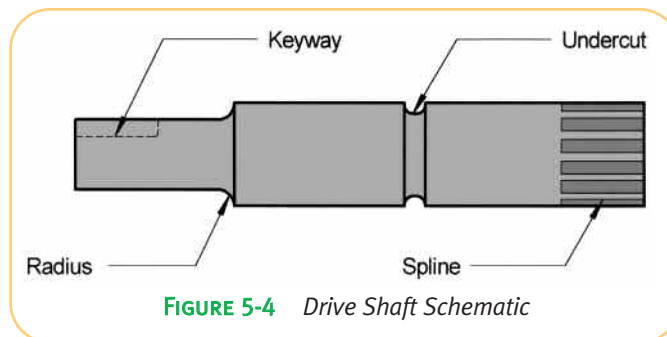

FIGURE 5-4 Drive Shaft Schematic

TORSION BARS

Torsion bars and anti-sway bars are structural members often used in suspensions and other related systems. The bars are used to maintain stability by resisting twisting motion. When used in systems subjected to repetitive loads such as vehicle suspensions, shot peening offers advantages of weight savings and extended service life.

APPLICATION CASE STUDY

AUTOMOTIVE TORSION BARS

The automotive industry has used hollow torsion bars as a means of weight savings. Shot peening was performed on the outer diameter where the highest load stresses occur. On heavy duty applications (four wheel drive utility trucks, sport utility vehicles, etc.) cracks can also occur on the inner diameter (ID), which also experiences torsional loads.

MIC is able to shot peen the ID using its lance shot peening methods. This provides necessary compressive stress throughout the torsion/anti-sway bar length.

REFERENCES:

- 5.1 Figure 5-2, Unigraphics Solutions, Inc. website (www.ugsolutions.com / www.solid-edge.com), June 2000
- 5.2 Lanke, Hornbach, Breuer; *Optimization of Spring Performance Through Understanding and Application of Residual Stress*; Wisconsin Coil Spring Inc., Lambda Research, Inc., Metal Improvement Company; 1999 Spring Manufacturer's Institute Technical Symposium; Chicago, IL May 1999

AXIAL FATIGUE

Axial fatigue is less common than other (fatigue) failure mechanisms. A smooth test specimen with axial loading has uniform stress throughout its cross section. For this reason, fatigue results of smooth, axial loaded shot peened specimens often do not show significant improvements in fatigue life. This is unlike bending and torsion that have the highest applied stress at the surface.

In most situations, pure axial loading is rare as it is normally accompanied by bending. Shot peening of axial loaded components is useful when there are geometry changes resulting in stress concentrations. Undercut grooves, tool marks, cross holes and radii are typical examples of potential failure initiation sites.

APPLICATION CASE STUDY

TRAIN EMERGENCY BRAKE PIN

FIGURE 6-1 is part of a hydraulic brake assembly used in a mass transit system. The undercut sections near the chamfered end were designed to fail in the event of axial overload. During the investigation of premature failures it was found that a bending load was also occurring. The combined axial and bending load when simulated in test caused fatigue failure between 150,000 – 2,600,000 cycles. Shot peening was added to the brake pin and all test specimens exceeded 6,000,000 cycles without failure [Ref 6.1].

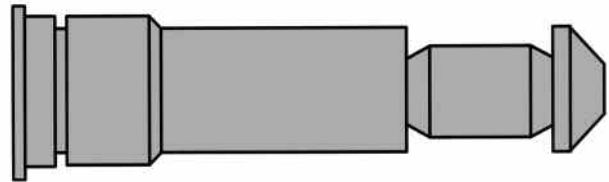

FIGURE 6-1 Brake Pin Schematic

APPLICATION CASE STUDY

AUXILIARY POWER UNIT (APU) EXHAUST DUCTS

This type of APU is used to provide power to aircraft when they are on the ground with the main engines turned off. The tubular exhaust ducts are a high temperature 8009 aluminum alloy welded in an end-to-end design.

Tension-tension fatigue tests measured fatigue strength of 23 ksi (156 MPa) at 3,000 cycles in the as welded condition. Glass bead peening of the welds resulted in a 13% fatigue strength improvement to 26 ksi (180 MPa) [Ref 6.2].

REFERENCES:

- 6.1 RATP, Cetim; Saint Etienne, France, 1996
- 6.2 Internal Metal Improvement Company Memo

FRETTING FAILURE

Fretting occurs when two highly loaded members have a common surface at which rubbing and sliding take place. Relative movements of microscopic amplitude result in surface discoloration, pitting and eventual fatigue. Fine abrasive oxides develop that further contribute to scoring of the surfaces. Other failure mechanisms, such as fretting corrosion and fretting wear, commonly accompany fretting failures.

Shot peening has been used to prevent fretting and eventual fretting failures by texturing the surface with a non-directional finish. This results in surface hardening (of certain materials) and a layer of compressive stress. The compressive layer prevents initiation and growth of fretting fatigue cracks from scoring marks as a result of fretting.

Fretting fatigue can occur when a rotating component is press fit onto a shaft. Vibration or shifting loads may cause the asperities of the press fit to bond and tear. The exposed surfaces will oxidize producing the "rusty powder" appearance of fretted steel.

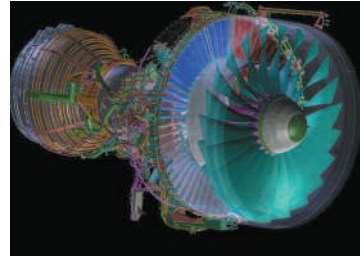

FIGURE 7-1 Turbine Engine Assembly

APPLICATION CASE STUDY

TURBOMACHINERY BLADES AND BUCKETS

A very common fretting environment is the dovetail root of turbomachinery blades. Shot peening is commonly used to prevent fretting failures of these roots. As shown in **FIGURE 7-2** the blade roots have the characteristic fir tree shape. The tight mating fit coupled with demanding loading conditions require that the surfaces be shot peened to prevent failure associated with fretting.

Many turbine and compressor blade roots are shot peened as OEM parts and re-shot peened upon overhaul to restore fatigue debits otherwise lost to fretting. The discs or wheels that support the blades should also be peened.

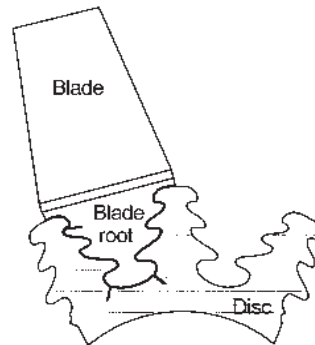

FIGURE 7-2 Turbine Blade and Disc Assembly

PITTING

Resistance to pitting fatigue is of primary concern for those who design gears and other components involved with rolling/sliding contact. Many gears are designed such that contact failure is the limiting factor in gear design. Though not desirable, pitting failures generally occur more gradually and with less catastrophic consequences than root bending failures.

Pitting failures initiate due to Hertzian and sliding contact stresses near the pitch line. When asperities from mating surfaces make contact, the loading is a complex combination of Hertzian and tensile stresses. With continued operation, a micro-crack may initiate. Crack growth will continue until the asperity separates itself leaving a "pit".

A condition of mixed lubrication is very susceptible to pitting failure. This occurs when the lubricant film is not quite thick enough to separate the surfaces and actual contact occurs between the asperities. **FIGURE 7-3** shows a gear flank and the mechanisms that cause pitting [Ref 7.2].

Shot peening has been proven to be highly beneficial in combating pitting fatigue when followed by a surface finish improvement process. By removing the asperities left from shot peening, the contact area is distributed over a larger surface area. It is important when finishing the shot peened surface to not remove more than 10% of the compressive layer. Please see Chapter 10 for photomicrographs of a shot peened and isotropically finished surface using the C.A.S.E.SM process.

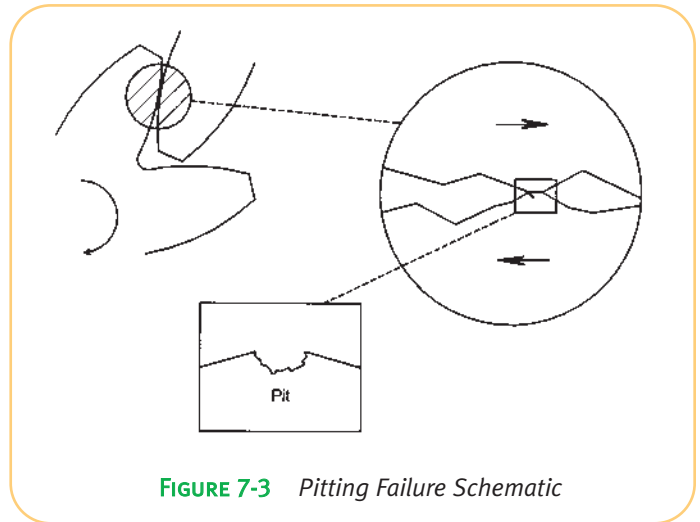

FIGURE 7-3 Pitting Failure Schematic

GALLING

Galling is an advanced form of adhesive wear that can occur on materials in sliding contact with no or only boundary lubrication. In its early stages it is sometimes referred to as scuffing. The adhesive forces involved cause plastic deformation and cold welding of opposing asperities. There is usually detachment of metal particles and gross transfer of fragments between surfaces. When severe, seizure may occur.

Shot peening can be beneficial for surfaces that gall particularly when the materials are capable of work hardening. The cold worked surface also contains dimples that act as lubricant reservoirs. The following materials have demonstrated positive response to galling with the assistance of shot peening: Inconel 718 and 750, Monel K-500 and alloys of stainless steel, titanium and aluminum.

REFERENCES:

- 7.1 Figure 7-1, Unigraphics Solutions, Inc. website (www.ugsolutions.com / www.solid-edge.com), June 2000
 7.2 Hahlbeck; Milwaukee Gear; Milwaukee, WI / Powertrain Engineers; Pewaukee, WI

CORROSION FAILURE

Tensile related corrosion failures can be derived from either static or cyclic tensile stresses. In both types of failures, environmental influences contribute to failure. Environments such as salt water and sour gas wells create metallurgical challenges. In most cases, these environments become more aggressive with increasing temperature.

STRESS CORROSION CRACKING

Stress corrosion cracking (SCC) failure is most often associated with static tensile stress. The static stress can be from applied stress (such as a bolted flange) or residual stress from manufacturing processes (such as welding). For SCC to occur three factors must be present:

- Tensile stress
- Susceptible material
- Corrosive environment

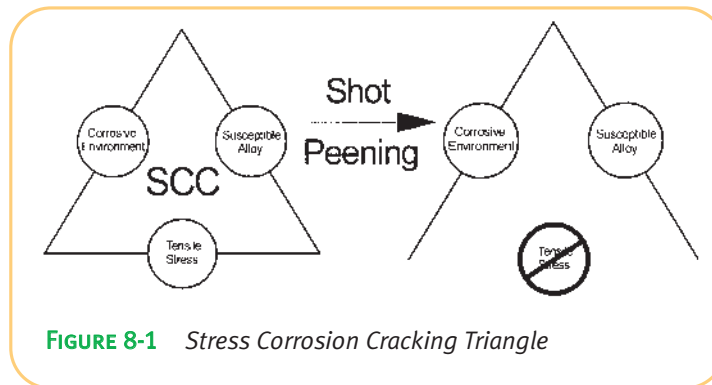

FIGURE 8-1 Stress Corrosion Cracking Triangle

FIGURE 8-1 shows the stress corrosion triangle in which each leg must be present for SCC to occur.

The compressive layer from shot peening removes the tensile stress leg of the SCC triangle. Without tensile stress, SCC failure is significantly retarded or prevented from ever occurring. The following is a partial list of alloys that are susceptible to SCC failure:

- Austenitic stainless steels
- Certain alloys (and tempers) of series 2000 and 7000 aluminum
- Certain nickel alloys
- Certain high strength steels
- Certain brasses

FIGURE 8-2 depicts a SCC failure. In austenitic 300 series stainless steel, the “river branching” pattern is unique to SCC and is often used in failure analysis for identification purposes of this material.



FIGURE 8-2 Stress Corrosion Cracking Failure of 300 Series Stainless Steel

APPLICATION CASE STUDY

FABRICATION OF CHEMICAL HANDLING EQUIPMENT

Shot peening has been utilized as a cost savings measure for construction of chemical handling equipment. In cases where ammonia or chloride based solutions were to be contained, a lower cost SCC susceptible material was selected with shot peening rather than a more expensive non-susceptible material. Even with the additional shot peening operation, construction costs were less than using the more expensive alloy.

The following table demonstrates the effectiveness of shot peening in combating stress corrosion cracking for the following stainless steel alloys. A load stress equivalent to 70% of the materials yield strength was applied [Ref 8.2].

Material	Peened (yes/no)	Test Life (hours)
316 SS	no	11.3
316 SS	yes	1000 N.F.
318 SS	no	3.3
318 SS	yes	1000 N.F.
321 SS	no	5.0
321 SS	yes	1000 N.F.

N.F. = No Failure

CORROSION FATIGUE

Corrosion fatigue is failure of components in corrosive environments associated with cyclic loading. Fatigue strength can be reduced by 50% or more when susceptible alloys are used in corrosive environments.

APPLICATION CASE STUDY

SULFIDE STRESS CRACKING

Hydrogen sulfide (H₂S) is commonly encountered in sour gas wells. Certain metal alloys when exposed to H₂S will experience a significant decrease in fatigue strength. The following test results illustrate the response of precipitation hardened 17-4 stainless steel exposed to H₂S with and without shot peening [Ref 8.3].

% of Yield Strength	As Machined (hrs. to fail)	As Machined and Shot Peened (hrs. to fail)
30	29.8	720 N.F.
40	37.9	561
50	15.4	538
60	15.2	219

N.F. = No Failure
Testing Done Per NACE TM-01-77 Test Standard

APPLICATION CASE STUDY

MEDICAL IMPLANTS

Medical science continues to evolve in replacing damaged and worn out body components. The implant materials (and associated fasteners) must be lightweight and high strength. In addition, the human body contains fluids that are corrosive to engineering metals.

Shot peening has been successfully utilized for combating both metal fatigue and corrosion fatigue in alloys of stainless steel and titanium.

INTERGRANULAR CORROSION

During the solution annealing process of austenitic stainless steels, chromium carbides precipitate to existing grain boundaries. This results in a depletion of chromium in the regions adjacent to the grain boundaries. Corrosion resistance is decreased such that the alloy is susceptible to intergranular corrosion (sensitized).

When shot peening is performed prior to the sensitization process, the surface grain boundaries are broken up. This provides many new nucleation sites for chromium carbide precipitation. The random precipitation of chromium carbides offers no continuous path for the corrosion to follow.

Significant improvements in intergranular corrosion resistance have been documented with shot peening prior to sensitization. No benefit is experienced when shot peening is performed after the sensitization process.

FIGURE 8-3A is a scanning electron microscope image of intergranular corrosion.

FIGURE 8-3B shows a primary crack as the darkened area and a secondary crack propagating through the grain boundaries.

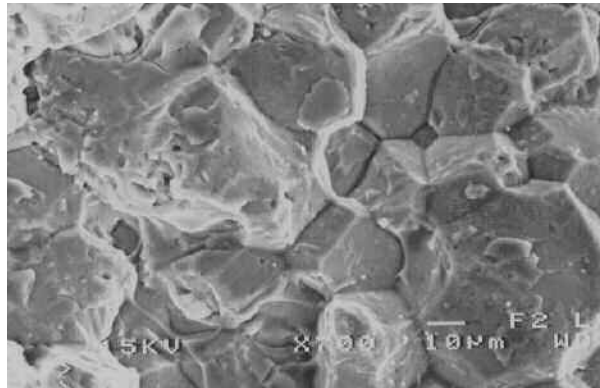

FIGURE 8-3A SEM Photo of Intergranular Corrosion

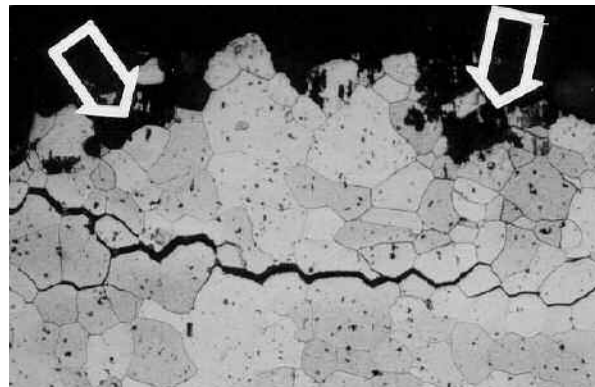

FIGURE 8-3B Primary and Secondary Cracking from Intergranular Corrosion

REFERENCES:

- 8.1 Figure 8-2, <http://corrosion.ksc.nasa.gov/html/stresscor.htm>, May 2001
- 8.2 Kritzler; *Effect of Shot Peening on Stress Corrosion Cracking of Austenitic Stainless Steels*, 7th International Conference on Shot Peening; Institute of Precision Mechanics; Warsaw, Poland, 1999
- 8.3 Gillespie; *Controlled Shot Peening Can Help Prevent Stress Corrosion*, Third Conference on Shot Peening; Garmisch-Partenkirchen, Germany, 1987
- 8.4 Figures 8-3A and 8-3B, <http://corrosion.ksc.nasa.gov/html/stresscor.htm>, May 2001

EFFECTS OF HEAT

Caution should be exercised when parts are heated after shot peening. The amount of compressive stress that is relieved is a function of temperature, time and material.

FIGURE 9-1 demonstrates the increasing stress relief effect of increasing temperature on shot peened Inconel 718 [Ref 9.1]. Inconel 718 is commonly used in high temperature jet engine applications.

Stress relief temperature is a physical property of the material. **FIGURE 9-2** depicts several materials and the temperatures at which residual stresses will begin to relax. Many shot peened fatigue applications operate above these lower temperature limits as fatigue benefits are still realized providing the operating temperature does not approach the stress relief temperature of the material.

The following are examples where shot peening followed by heat treatment is commonly incorporated into manufacturing:

- Springs – It is common to perform a post-bake operation for improvements in spring performance. Please see Chapter 5 – Torsional Fatigue.
- Plated Parts – It is common for shot peening prior to plating. Peening is called out for fatigue benefits and resistance to hydrogen embrittlement. Please see Chapter 3 – Manufacturing Processes. Plating commonly involves a hydrogen bake operation at 350-400 °F (175-205 °C) for several hours.

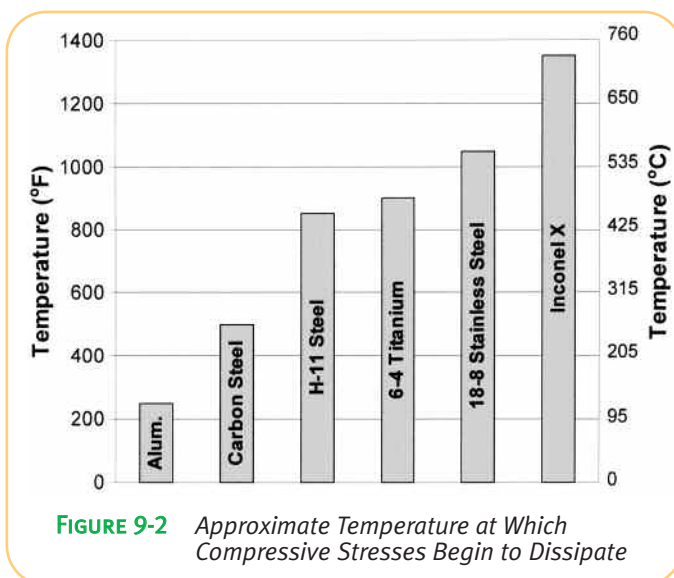
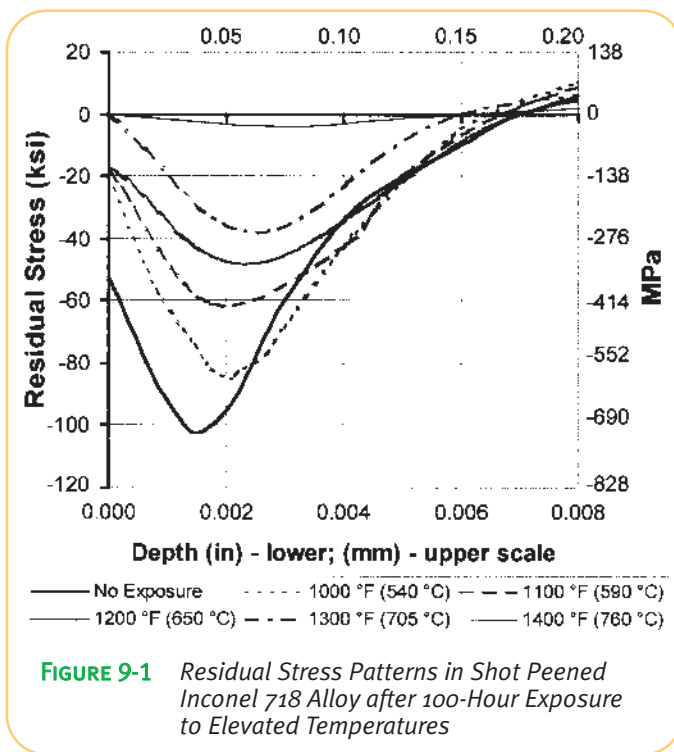

THERMAL FATIGUE

Thermal fatigue refers to metal failures brought on by uneven heating and cooling during cyclic thermal loading. Rapid heating and cooling of metal induces large thermal gradients throughout the cross section, resulting in uneven expansion and contraction. Enough stress can be generated to yield the metal when one location attempts to expand and is resisted by a thicker, cooler section of the part.

Thermal fatigue differs from elevated temperature fatigue that is caused by cyclic mechanical stresses at high temperatures. Often, both occur simultaneously because many parts experience both temperature excursions and cyclic loads.

APPLICATION CASE STUDY

FEEDWATER HEATERS

Large thermal fatigue cracks were discovered in eight high pressure feedwater heaters used for power generation. These units operate in both an elevated temperature and thermal fatigue environment. Startups and shut downs cause thermal fatigue. Steady state operation is at 480-660 °F (250-350 °C).

The cracks were circumferential in the weld heat affected zone between the water chamber and tubesheet. Fatigue cracking was attributed to years of service and 747 startups and shutdowns of the unit. This caused concern about the remaining life of the units.

The cracked locations were machined and shot peened. Subsequent inspections showed that no additional fatigue cracks developed after five years of service and 150 startup and shutdown cycles [Ref 9.2].

REFERENCES:

- 9.1 *Surface Integrity, Tech Report, Manufacturing Engineering; July 1989*
- 9.2 *Gauchet; EDF Feedback on French Feedwater Plants Repaired by Shot Peening and Thermal Stresses Relaxation Follow-Up, Welding and Repair Technology for Fossil Power Plants; EPRI, Palo Alto, CA; March 1994*

PEEN FORMING

Peen forming is the preferred method of forming aerodynamic contours into aircraft wingskins. It is a dieless forming process that is performed at room temperature. The process is ideal for forming wing and empennage panel shapes for even the largest aircraft. It is best suited for forming curvatures where the radii are within the elastic range of the metal. These are large bend radii without abrupt changes in contour.

Residual compressive stress acts to elastically stretch the peened side as shown in **FIGURE 10-1**. The surface will bend or "arc" towards the peened side. The resulting curvature will force the lower surface into a compressive state. Typically aircraft wingskins have large surface area and thin cross sectional thickness. Therefore, significant forces are generated from the shot peening residual stress over this large surface area. The thin cross section is able to be manipulated into desired contours when the peen forming is properly engineered and controlled.

A properly engineered peen forming procedure will compensate for varying curvature requirements, varying wingskin thickness, cutouts, reinforcements and pre-existing distortion. **FIGURE 10-2** demonstrates a wingskin that has multiple contours along its length. The wingskin is positioned on a checking fixture that verifies correct contour.

Peen forming is most often performed on a feed through, gantry type machine (**FIGURE 10-3**).

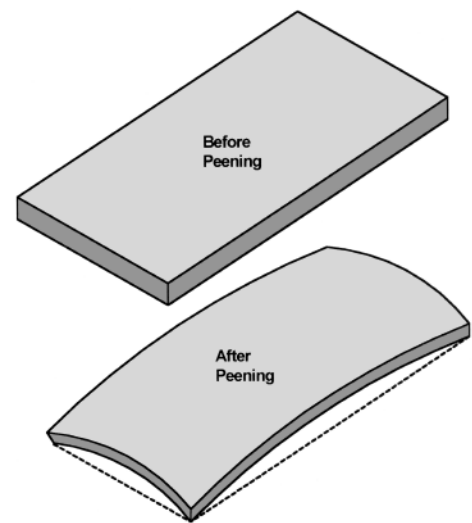

FIGURE 10-1 Thin Cross Section Before and After Shot Peening

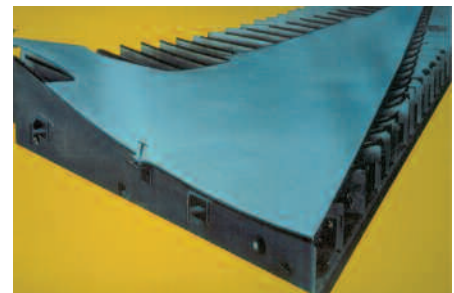

FIGURE 10-2 Checking Fixture for Verifying Peen Forming of Wingskin

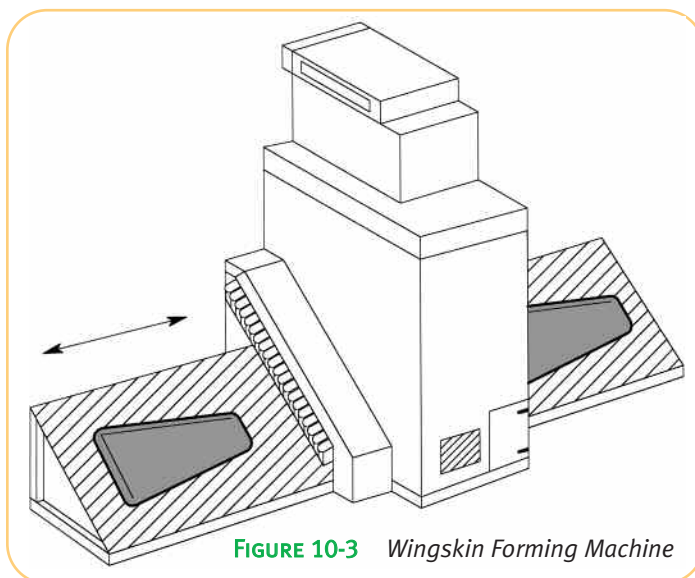

FIGURE 10-3 Wingskin Forming Machine

Peen forming has the following advantages:

- No forming dies are required.
- Process is performed at room temperature.
- Wingskin design changes are easily accomplished by altering the peen forming procedure. There is no expensive modification of dies required.
- All forming is accomplished using residual compressive stress. Peen formed parts exhibit increased resistance to flexural bending fatigue and stress corrosion cracking as a result.
- Peen formed skins exhibit compressive stress on top and bottom surfaces.

The majority of aircraft in production with aerodynamically formed aluminum alloy wingskins employ the peen forming process.

Metal Improvement Company (MIC) has developed computer modeling techniques that allow feasibility studies of particular designs. The program takes three-dimensional engineering data and, based on the degree of compound curvature, calculates and illustrates the degree of peen forming required. It also exports numerical data to define the peening that is required to obtain the curvatures. A significant advantage of these techniques is that MIC can assist aircraft wing designers in the early stages of design. These techniques insure that the desired aerodynamic curvatures are met with economically beneficial manufacturing processes (FIGURE 10-4).

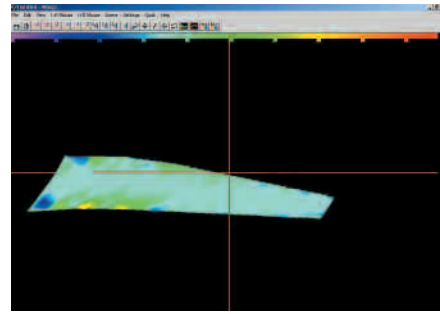

FIGURE 10-4 Computer Modeling of Peen Forming Operation

CONTOUR CORRECTION

Shot peening utilizing peen forming techniques can be used to correct unfavorable geometry conditions. This is accomplished by shot peening selective locations of parts to utilize the surface loading from the induced compressive stress to restore the components to drawing requirements. Some examples are:

- Driveshaft/crankshaft straightening
- Roundness correction of ring shaped geometry
- Aircraft wing stiffener adjustment
- Welding distortion correction

The peen forming process avoids the unfavorable tensile residual stresses produced by other straightening methods by inducing beneficial compressive residual stresses.

WORK HARDENING

A number of materials and alloys have the potential to work harden through cold working. Shot peening can produce substantial increases in surface hardness for certain alloys of the following types of materials:

- Stainless steel
- Aluminum
- Manganese stainless steels
- Inconel
- Stellite
- Hastelloy

This can be of particular value to parts that cannot be heat treated but require wear resistance on the surface. The table illustrates examples of increases in surface hardness with shot peening.

<i>Material</i>	<i>Before Shot Peen</i>	<i>After Shot Peen</i>	<i>Percent Increase</i>
Cartridge Brass	50 HRB	175 HRB	250
304 Stainless	243 HV	423 HV	74
316L Stainless	283 HV	398 HV	41
Mn Stainless	23 HRC	55 HRC	139
Inconel 625	300 HV	500 HV	67
Stellite	42 HRC	54 HRC	29
Hastalloy C	18 HRC	40 HRC	122 *
Hastalloy C	25 HRC	45 HRC	80 **

* Wrought condition ** Cast condition

PEENTEXSM

Controlled shot peening also can be used to deliver a number of different, aesthetically pleasing surface finishes. MIC stocks a great variety of media types and sizes. These media range from fine glass to large steel (and stainless steel) balls. Using a carefully controlled process, MIC is able to provide architectural finishes that are consistent, repeatable and more resistant to mechanical damage through work hardening.

Shot peening finishes have been used to texture statues, handrails, gateway entrances, building facades, decorative ironwork and numerous other applications for visual appeal. When selecting a decorative finish, MIC recommends sampling several finishes for visual comparison. **FIGURE 10-5** is a hand rail utilizing a chosen Peentexsm finish (left side of **FIGURE 10-5**) to dull the glare from the untextured finish (right side).

A textured surface is able to hide surface scratches and flaws that would otherwise be highly visible in a machined or ground surface. It is common to texture molds used for making plastics to hide surface defects. The texture on the mold surface will become a mirror image on the plastic part's surface.

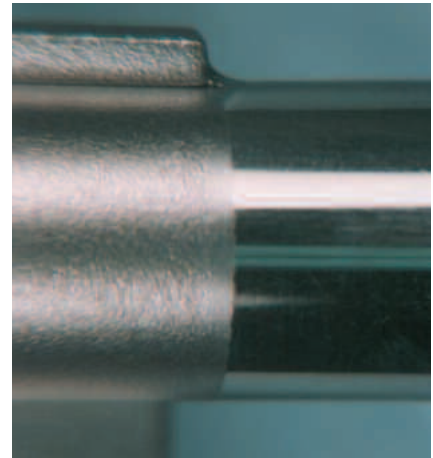

FIGURE 10-5 Before (right) and After (left) Comparison of Peentexsm

ENGINEERED SURFACES

Engineered surfaces are those that are textured to enhance surface performance. The following are potential surface applications achieved through shot peening:

- In most cases, a textured surface has a lower coefficient of (sliding) friction than a non-textured surface. This is because the surface contact area is reduced to the "peaks" of the shot peening dimples.
- In some applications, the "valleys" of the peening dimples offer lubricant retention that are not present in a smooth surface.
- In some instances, a non-directional textured surface is desired over a uni-directional machined/ground surface. This has proven effective in certain sealing applications.
- In certain mold applications, a textured surface has less vacuum effect resulting in desirable "release" properties.

APPLICATION CASE STUDY

PNEUMATIC CONVEYOR TUBING

Pneumatic conveyor tubing can be up to 10 inches in diameter and is usually a stainless or aluminum alloy. It is used to transport plastic pellets at facilities consisting of molding companies or various production, blending and distribution sites. Transported pellets degrade when contact is made with internal piping surfaces. The velocity of the pellets results in friction, heat and lost production.

Using a variation on Peentexsm that produces directional dimpling, MIC offers a directionally textured surface that significantly reduces the formation of fines, fluff and streamers that can

account for millions of pounds of lost and/or contaminated production each year. Directional shot peening has been found to be much superior to other internal treatments of the tubing, often is more economical and can

<i>Treatment</i>	<i>Fines (grams/100,000 lb conveyed)</i>
Directional Shot Peened	1,629
Smooth Mill Finish	4,886
Spiral Groove Pipe	6,518
Sandblasted Pipe	7,145
Polyurethane Coated	7,215
Medium Scored Pipe	13,887



FIGURE 10-6 *Manufacturing Plant Utilizing Directionally Textured Pipe*

be applied on-site. The directional surface finish has the added benefit of work hardening (when stainless or aluminum piping is used), extending the life of the surface treatment.

The table shows test results from six different internal pipe treatments. A lower value of fines per 100,000 lbs conveyed is desirable. The directional shot peening resulted in one third of the fines of the next closest finish [Ref 10.1].

APPLICATION CASE STUDY

FOOD INDUSTRY

The cheese/dairy industry has found that uniform dimples provide a surface that can advantageously replace other surface treatments. The textured surface from shot peening often has a lower coefficient of sliding friction that is necessary for cheese release properties on some food contact surfaces. The dimples act as lubricant reservoirs for fat or other substances allowing the cheese product to slide easier through the mold on the peaks of the shot peening dimples.

Testing has shown that shot peened finishes meet or exceed necessary cleanability requirements in terms of microbial counts. This is due to the rounded dimples that do not allow bacteria to collect and reproduce. Sharp impressions left from grit blasting, sand blasting or broken media have proved to be less cleanable and have a much greater tendency for bacteria to collect and reproduce [Ref 10.2]. Both glass beaded and stainless steel media have been used successfully in this application.

FIGURE 10-7 depicts a single cavity cheese mold. MIC has successfully textured many geometries and sizes of cheese molds.

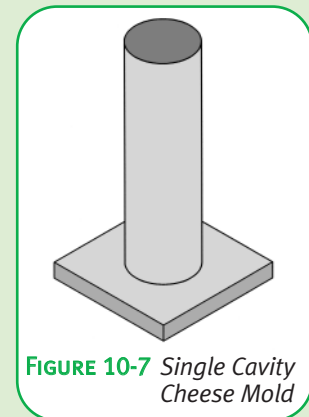

FIGURE 10-7 *Single Cavity Cheese Mold*

EXFOLIATION CORROSION

A large number of commercial aircraft are over 20 years old. Ultimately, the safety of older aircraft depends on the quality of the maintenance performed. An aged Boeing 737 explosively depressurized at 24,000 feet (7300 m) when 18 feet (6 m) of the fuselage skin ripped away. The cause of the failure was corrosion and metal fatigue [Ref 10.3].

MIC has developed a process called Search Peeningsm to locate surface and slightly sub-surface corrosion. Exfoliation corrosion is a form of intergranular corrosion that occurs along aluminum grain boundaries. It is characterized by delamination of thin layers of aluminum with corrosion products between the layers. It is commonly found adjacent to fasteners due to galvanic action between dissimilar metals.

In exfoliation corrosion, the surface bulges outward as shown in **FIGURE 10-8**. In severe cases, the corrosion is subsurface.

Once corrosion is present repairmen can manually remove it with sanding or other means. Shot peening is then applied to compensate for lost fatigue strength as a result of material removal. Additional sub surface corrosion will appear as "blisters" exposed from the shot peening process. If additional corrosion is found, it is then removed and the Search Peeningsm process repeated until no more "blistering" occurs.

MIC is capable of performing the Search Peeningsm on site at aircraft repair hangers. Critical areas of the aircraft are masked off by experienced shot peening technicians before beginning the process.



FIGURE 10-8 Exfoliation Corrosion

POROSITY SEALING

Surface porosity has long been a problem that has plagued the casting and powder metal industries. Irregularities in the material consistency at the surface may be improved by impacting the surface with shot peening media. By increasing the intensity (impact energy), peening can also be used to identify large, near-surface voids and delaminations.

INTERNAL SURFACES AND BORES

When the depth of an internal bore is greater than the diameter of the hole it cannot be effectively shot peened by an external method. An internal shot peening lance or internal shot deflector (ISD) method must be used under closely controlled conditions (**FIGURE 10-9**). Holes as small as 0.096 inch (2.4 mm) in jet engine disks have been peened on a production basis using the ISD method. Potential applications for internal shot peening include:

- Tie wire holes
- Hydraulic cylinders
- Helicopter spars
- Drill pipes
- Propeller blades
- Shafts with lubrication holes
- Compressor and turbine disk blade slots

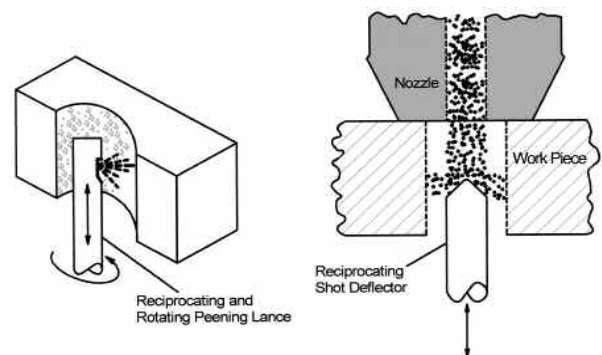

FIGURE 10-9 Lance Peening and Internal Shot Deflector Peening

MIC developed an intensity verification technique for small holes. **FIGURE 10-10** shows the results of a study to a jet engine disk comparing the residual stress on the external surface (peened with conventional nozzles) to that on internal surfaces of a small bore peened with internal shot deflector methods. Using the same shot size and intensity, the two residual stress profiles from these controlled processes were essentially the same [Ref 10-4].

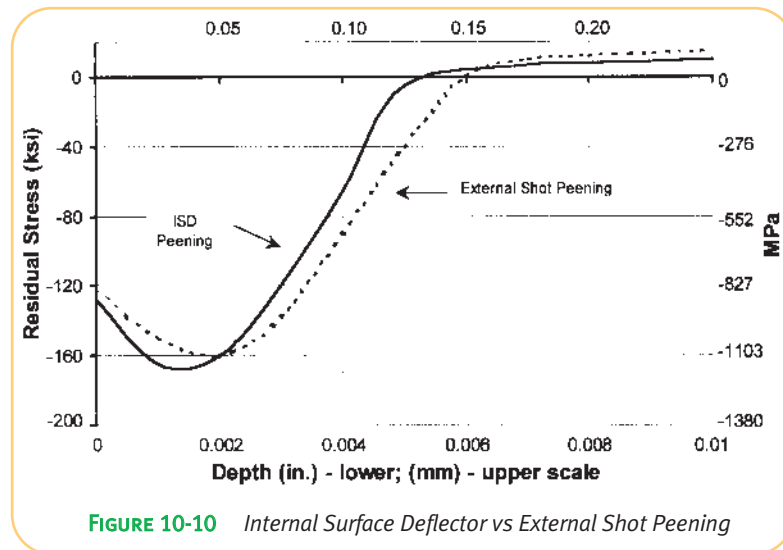

FIGURE 10-10 Internal Surface Deflector vs External Shot Peening

DUAL (INTENSITY) PEENING

Dual peening (or Dura Peensm) is used to further enhance the fatigue performance from a single shot peen operation. Fatigue life improvements from shot peening typically exceed 300%, 500%, or more. When dual peened, (single) shot peen results can often be doubled, tripled or even more.

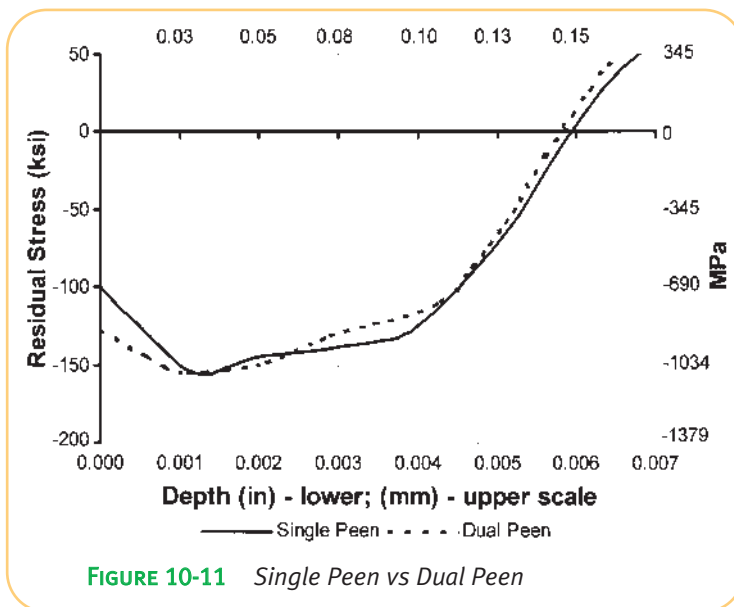

FIGURE 10-11 Single Peen vs Dual Peen

imparted to the surface. **FIGURE 10-11** shows approximately 30 ksi of additional compression at the surface when performing dual peening for a chrome silicon spring wire [Ref 10.5].

Dual peening is usually performed by shot peening the same surface a second time with a smaller media at a reduced intensity. The second peening operation is able to hammer down the asperities from the first peening resulting in an improved surface finish. The effect of driving the asperities into the surface results in additional compressive stress at the surface. **FIGURES 10-12** and **10-13** show the surface finishes from the single and dual peen at 30x magnification recorded in the graph shown in **FIGURE 10-11** [Ref 10.5].

The purpose of dual peening is to improve the compressive stress at the outermost surface layer. This is where fatigue crack initiation begins. By further compressing the surface layer, additional fatigue crack resistance is

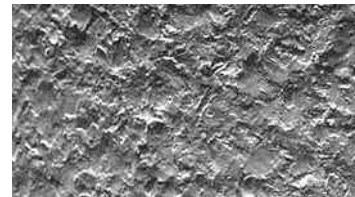

FIGURE 10-12 SEM Photo of Single Peen Surface Finish

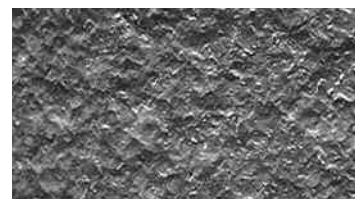

FIGURE 10-13 SEM Photo of Dual Peen Surface Finish

THE C.A.S.E.SM PROCESS

The C.A.S.E.SM process consists of shot peening followed by isotropic finishing. The isotropic finishing removes the asperities left from shot peening via vibratory polishing techniques while maintaining the integrity of the residual compressive layer. The process is performed in a specially formulated chemical solution to reduce processing time making it feasible for high production components.

C.A.S.E.SM was designed for surfaces that require both excellent fatigue strength and surface finish due to contact loading. C.A.S.E.SM has proven quite effective in improving resistance to pitting and micro-pitting of gears. Many gear designs are limited by pitting fatigue as the critical factor for load considerations.

Shot peening is performed to both the tooth flanks and roots with isotropic finishing being concentrated on the flanks. Improvements in surface finish allow for contact loading to be distributed over more surface area reducing contact stress and extending pitting fatigue life.

Transmission gears utilized in aerospace, automotive and off-highway applications are ideal applications for the C.A.S.E.SM process. They are expected to run for many years under high root bending loads and tooth flank contact loads. C.A.S.E.SM has proven successful for applications in all these industries.

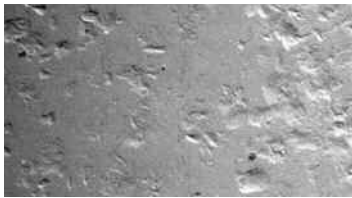

FIGURE 10-14 SEM Photo of C.A.S.E.SM Surface Finish

FIGURE 10-14 shows a typical C.A.S.E.SM finish at a 30x magnification [Ref 10.5]. The as-shot-peened finish would be similar to **FIGURE 10-12**. The process is designed to leave some of the "valleys" from the peened finish for lubricant retention.

Surface finishes of 10 micro-inches (Ra) or better are attainable on carburized gears. **FIGURE 10-15** shows a typical roughness profile of a carburized gear after shot peening

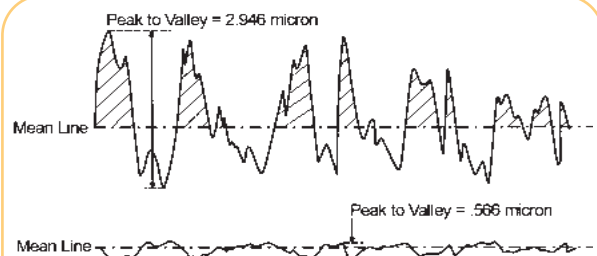

FIGURE 10-15 Surface Roughness After Shot Peening and After C.A.S.E.SM Finishing

and also after the isotropic finishing portion of C.A.S.E.SM processing. The "peak to valley" of the shot peened finish is ~ 2.9 microns. After isotropic finishing this improves to ~ 0.6 microns. The Rsk following isotropic finishing can approach -1.1 as it selectively changes asperities to plateaus leaving the valleys from the shot peening.

ON-SITE SHOT PEENING

Large components that have been installed on their foundations or whose size exceed shipping limitations can be shot peened by certified crews with portable equipment. Field crews perform shot peening worldwide to the same quality standards as MIC's processing centers. Almen strips, proper coverage and certified peening media are utilized as described in Chapter 11 – Quality Control.

Examples of portable shot peening projects that have been successfully performed include:

- Welded fabrications (pressure vessels, crusher bodies, ship hulls, chemical storage tanks, bridges).
- Aircraft overhaul repair and corrosion removal (wing sections, landing gear, other dynamically loaded components).
- Power plant components (heat exchanger tubing, turbine casings, rotating components, large fans).
- Plastic pellet transfer facilities for directional peening.
- Miscellaneous processing plants (steel mills, paper mills, mining facilities).

STRAIN PEENING

Strain (or stress) peening offers the ability to develop additional residual compressive stress offering more fatigue crack resistance. Whereas dual peening offers improvements at the outermost surface layer, strain peening develops a greater amount of compressive stress throughout the compressive layer.

To perform strain peening, a component must be physically loaded in the same direction that it experiences in service prior to peening. Extension springs must be stretched, compression springs must be compressed and drive shafts must be pre-torqued. This will offer maximum (residual) compressive stress opposing the direction of (applied) tensile stress created during cyclic loading.

The additional compressive stress is generated by preloading the part within its elastic limit prior to shot peening. When the peening media impacts the surface, the surface layer is yielded further in tension because of the preloading. The additional yielding results in additional compressive stress when the metal's surface attempts to restore itself.

FIGURE 10-16 shows the additional compressive stress that is achieved when strain peening 50CrV4 [Ref 10.7]. The graph demonstrates that more residual compression is achieved when more preload is applied. While the increased compression is desired from strain peening, processing costs are higher due to fabrication of fixtures and additional handling to preload components before shot peening.

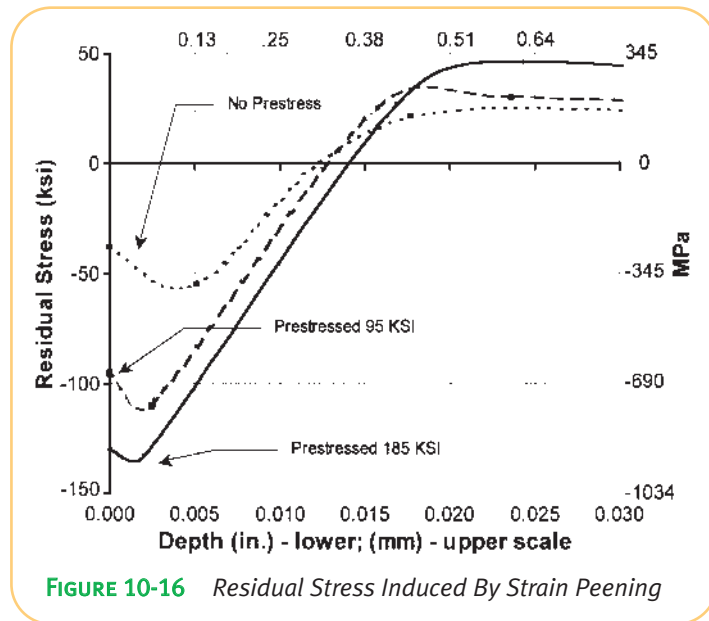

FIGURE 10-16 Residual Stress Induced By Strain Peening

REFERENCES:

- 10.1 Paulson; *Effective Means for Reducing Formation of Fines and Streamers in Air Conveying Systems*, Regional Technical Conference of the Society of Plastics Engineering; 1978, Flo-Tronics Division of Allied Industries; Houston, TX
- 10.2 Steiner, Maragos, Bradley; *Cleanability of Stainless Steel Surfaces With Various Finishes*; Dairy, Food, and Environmental Sanitation, April 2000
- 10.3 Eckersley; *The Aging Aircraft Fleet, IMPACT*; Metal Improvement Company
- 10.4 Happ; *Shot Peening Bolt Holes in Aircraft Engine Hardware*; 2nd International Conference on Shot Peening; Chicago, IL May 1984
- 10.5 Lanke, Hornbach, Breuer; *Optimization of Spring Performance Through Understanding and Application of Residual Stress*; Wisconsin Coil Spring Inc., Lambda Research, Inc., Metal Improvement Company; 1999 Spring Manufacturer's Institute Technical Symposium; Chicago, IL May 1999
- 10.6 Metallurgical Associates, Inc; Waukesha, WI 1999
- 10.7 Muhr; *Influence of Compressive Stress on Springs Made of Steel Under Cyclic Loads*; Steel and Iron, December 1968

CONTROLLING THE PROCESS

Controlled shot peening is different than most manufacturing processes in that there is no nondestructive method to confirm that it has been performed to the proper specification. Techniques such as X-Ray Diffraction require that a part be sacrificed to generate a full compressive depth profile analysis. To ensure peening specifications are being met for production lots, the following process controls must be maintained:

- Media
- Intensity
- Coverage
- Equipment

Metal Improvement Company (MIC) currently meets or exceeds the most stringent quality standards requested by its industrial, automotive and aerospace customers. Based on local industry requirements, our facilities maintain quality system compliance or registration to ISO9001:2000, TS-16949:2002 and/or AS9100. Further, MIC facilities that support the aerospace community participate in Nadcap's rigorous accreditation program.

MEDIA CONTROL

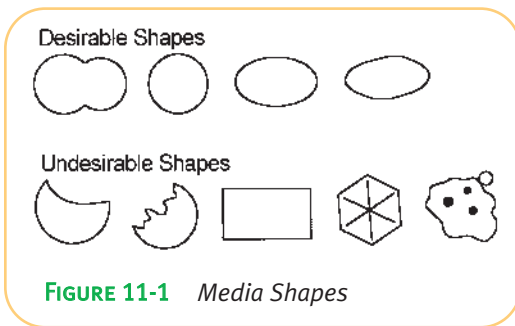

FIGURE 11-1 demonstrates acceptable and unacceptable media shapes. Peening media must be predominantly round. When

media breaks down from usage, the broken media must be removed to prevent surface damage upon impact. **FIGURE 11-2A** (100x magnification) demonstrates the potential for surface damage and crack initiation from using broken down media.

FIGURE 11-2B (100x magnification) demonstrates what a properly peened surface should look like.

Peening media must be of uniform diameter. The impact energy imparted by the media is a function of its mass and velocity. Larger media has more mass and impact energy. If a mixed size batch of media is used for peening, the larger media will drive a deeper residual compressive layer. This results in a non-uniform residual compressive layer and will correlate into inconsistent fatigue results. **FIGURE 11-3A** shows a batch of media with proper size and shape characteristics.

FIGURE 11-3B shows unacceptable media.



FIGURE 11-2A Damaged Surface from Broken Shot Media

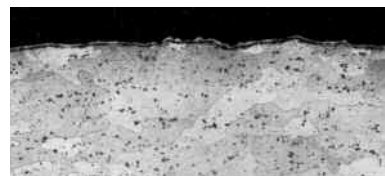

FIGURE 11-2B Typical Surface from Proper Media



FIGURE 11-3A High Quality Shot Peening Media

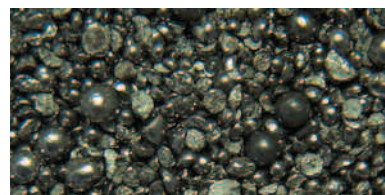

FIGURE 11-3B Poor Quality Shot Peening Media

To properly remove undersized and oversized media, MIC utilizes a screening system. To properly remove broken media, MIC meters the shot to a spiral separator consisting of inner and outer flights. The system is based on the rolling velocity of spherical media versus broken media. Shot will arrive via the channel above the cone near the top of **FIGURE 11-4**. The media will fall to the cone and roll down the inner flight. Spherical media will gain enough velocity to escape to the outer flight. This media can be reused. Broken down media rolls very poorly and will stay on the inner flight where it will be discarded.



FIGURE 11-4 *Spiral Separation System for Shot Media Classification*

INTENSITY CONTROL

Shot peening intensity is the measure of the energy of the shot stream. It is one of the essential means of ensuring process repeatability. The energy of the shot stream is directly related to the compressive stress that is imparted into a part. Intensity can be increased by using larger media and/or increasing the velocity of the shot stream. Other variables to consider are the impingement angle and peening media.

Intensity is measured using Almen strips. An Almen strip consists of a strip of SAE1070 spring steel that is peened on one side only. The residual compressive stress from the peening will cause the Almen strip to bend or arc convexly towards the peened side (**FIGURE 11-5**). The Almen strip arc height is a function of the energy of the shot stream and is very repeatable.

There are three Almen strip designations that are used depending on the peening application:

- “N” Strip: Thickness = 0.031" (0.79 mm)
- “A” Strip: Thickness = 0.051" (1.29 mm)
- “C” Strip: Thickness = 0.094" (2.39 mm)

More aggressive shot peening utilizes thicker Almen strips.

The Almen intensity is the arc height (as measured by an Almen gage) followed by the Almen strip designation. The proper designation for a 0.012" (0.30 mm) arc height using the A strip is 0.012A (0.30A). The usable range of an Almen strip is 0.004" -0.024" (0.10-0.61 mm). The next thicker Almen strip should be called out if intensity is above 0.020" (0.51 mm).

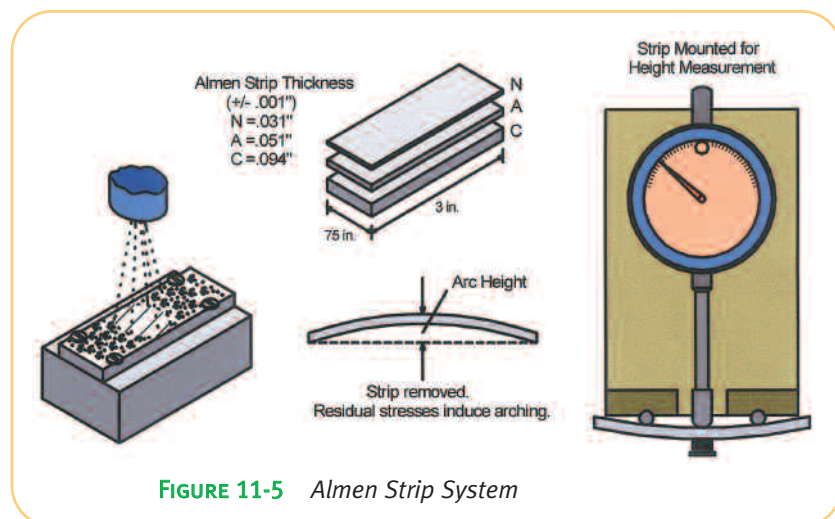

FIGURE 11-5 *Almen Strip System*

The intensity value achieved on an N strip is approximately one-third the value of an A strip. The intensity value achieved on a C strip is approximately three times the value of an A strip ($N \sim 1/3A$, $C \sim 3A$).

Almen strips are mounted to Almen blocks and are processed on a scrap part (FIGURE 11-6) or similar fixture. Almen blocks should be mounted in locations where verification of impact energy is crucial. Actual intensity is verified and recorded prior to processing the first part. This verifies the peening machine is set up and running according to the approved, engineered process. After the production lot of parts has been processed, intensity verification is repeated to insure processing parameters have not changed. For long production runs, intensity verifications will be performed throughout the processing as required.

Saturation (Intensity Verification) – Initial verification of a process development requires the establishment of a saturation curve. Saturation is defined as the earliest point on the curve where doubling the exposure time produces no more than a 10% increase in arc height. The saturation curve is developed by shot peening a series of Almen strips in fixed machine settings and determining when the doubling occurs.

FIGURE 11-7 shows that doubling of the time ($2T$) from the initial exposure time (T) resulted in less than a 10% increase in Almen arc height. This would mean that the process reaches saturation at time = T . Saturation establishes the actual intensity of the shot stream at a given location for a particular machine setup.

It is important to not confuse saturation with coverage. Coverage is described in the next section and deals with the percentage of surface area covered with shot peening dimples. Saturation is used to verify the time to establish intensity. Saturation and coverage will not necessarily occur at the same time interval. This is because coverage is determined on the actual part surface which can range from relatively soft to extremely hard. Saturation is determined using Almen strips that are SAE1070 spring steel hardened to 44-50 HRC.

COVERAGE CONTROL

Complete coverage of a shot peened surface is crucial in performing high quality shot peening. Coverage is the measure of original surface area that has been obliterated by shot peening dimples. Coverage should never be less than 100% as fatigue and stress corrosion cracks can develop in the non-peened area that is not encased in residual compressive stress. The adjacent pictures demonstrate complete and incomplete coverage. (FIGURES 11-8A AND 11-8B)

If coverage is specified as greater than 100% (i.e. 150%, 200%) this means that the processing time to achieve 100% has been increased by that factor. A coverage of 200% time would have twice the shot peening exposure time as 100% coverage.



FIGURE 11-6 Almen Strip Mounting Fixture

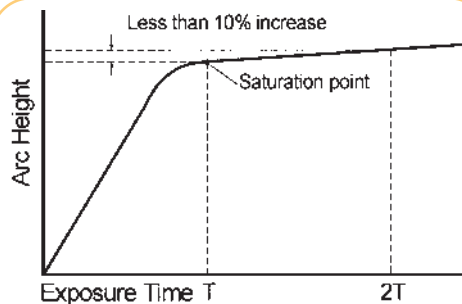

FIGURE 11-7 Saturation Curve

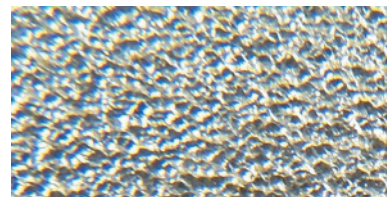

FIGURE 11-8A Complete Shot Peening Coverage

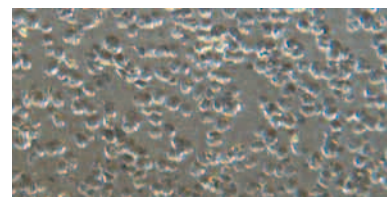

FIGURE 11-8B Incomplete Shot Peening Coverage

PEENSCAN® (Coverage Verification) – Determination of shot peening coverage can be fairly easy when softer materials have been peened because the dimples are quite visible. A 10-power (10x) magnifying glass is more than adequate for these conditions. In many applications determination of coverage is more difficult. Internal bores, tight radii, extremely hard materials and large surface areas present additional challenges in determining coverage.

MIC has developed the PEENSCAN® process using DYESCAN® fluorescent tracer dyes for this reason. PEENSCAN® is ideal for measuring uniformity and extent of coverage for difficult conditions. The whitish-green dye is not visible under normal lighting conditions and must be viewed under a UV (black) light.

The coating can be applied by dipping, brushing or spraying the part under analysis. As the coated surface is impacted with peening media, the impacts remove the fluorescent, elastic coating at a rate proportional to the actual coverage rate. When the part is viewed again under a black light non-uniform coverage is visibly evident. The shot peening process parameters can then be adjusted until the PEENSCAN® procedure verifies complete obliteration of the area of concern.

FIGURE 11-9A THROUGH 11-9C demonstrate the PEENSCAN® concept. The figures are computer simulations of a turbine blade with the green representing the whitish-green dye (under black light conditions). As the (green) dye is removed from peening impacts, the (blue) base material is exposed indicating complete coverage.

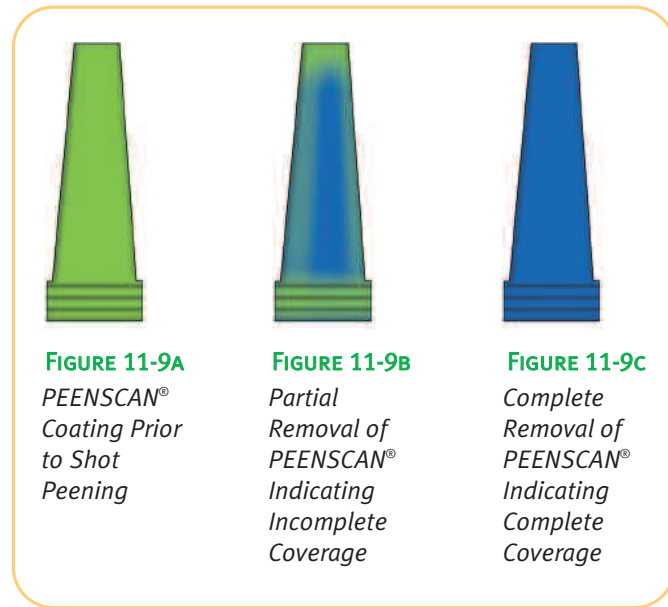

The PEENSCAN® inspection process has been found to be clearly superior to using a 10-power glass.

AUTOMATED SHOT PEENING EQUIPMENT

Throughout the world, MIC service centers are equipped with similar types of automated shot peening equipment. When required, this network allows for efficient, economic and reliable transfer or duplication of shot peen processing from one location to another.

MIC also offers Computer Monitored Shot Peening (CMSP), which utilizes additional process controls and records data during the production shot peening of each part. For components designed to incorporate shot peening for product life enhancement, customers should request adherence to the computer monitored process specification AMS-2432.

MIC has developed CMSP equipment that has the capability to monitor, control and document the following parameters of the peening process:

- Air pressure and shot flow (energy) at each nozzle
- Wheel speed and shot flow (energy) of each wheel
- Part rotation and/or translation
- Nozzle reciprocation
- Cycle time

These parameters are continuously monitored and compared to acceptable limits programmed into the computer. If an unacceptable deviation is found, the machine will automatically shut down within one second and report the nature and extent of deviation. The machine will not restart processing until machine parameters have been corrected.

A printout is available upon completion of the CMSP. Any process interruptions are noted on the printout. The process is maintained in MIC quality records and is available for review. **FIGURE 11-10A** is a CMSP machine used for peening internal bores of aerospace components. **FIGURE 11-10B** is a multi-nozzle CMSP machine. Both figures show the central processing unit on the side of the machine.



FIGURE 11-10A Computer Monitored Lance Shot Peening Machine for Processing Internal Bores

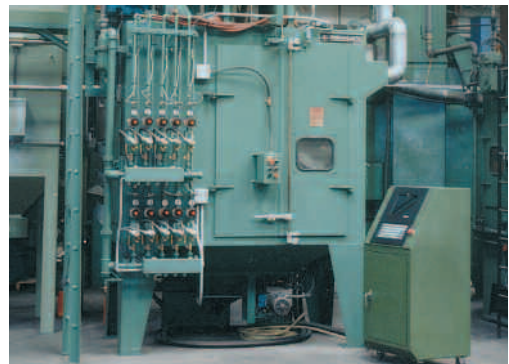

FIGURE 11-10B Multi-Nozzle Computer Monitored Shot Peening Machine

APPLICATION CASE STUDY

CMSP INCREASES TURBINE ENGINE SERVICE LIFE

CMSP registered significant interest when the FAA allowed a rating increase on a turbine engine from 700 to 1,500 cycles between overhauls. This increase made it possible for the engine, which was designed for military use, to enter the commercial market.

There was minimal space for design modifications so the engine manufacturer chose to use shot peening to improve life limited turbine disks and cooling plates. CMSP ensured that the peening parameters of the critical components were documented and repeated precisely [Ref 11.1].

SPECIFYING SHOT PEENING

FIGURE 11-11 shows a splined shaft (shaded) installed with two bearings supporting the shaft inside an assembly. The outboard spline and adjacent radius would be likely fatigue failure locations from bending and/or torsional fatigue. In this case, engineering would specify shot peening (of the shaft) on the drawing as follows:

- Area "A": Shot peen
- Area "B": Overspray allowed
- Area "C": Masking required

The details on the print should read:

- Shot peen splined areas and adjacent radius using MI-110H shot; 0.006" -0.009" A intensity.
- Minimum 100% coverage in splined areas to be verified by PEENSCAN®.
- Overspray acceptable on adjacent larger diameter.
- Mask both bearing surfaces and center shaft area.
- Shot peening per AMS-S-13165.

It is important to note that if Non-Destructive Testing is required, NDT should always be performed before shot peening. The peening process will obliterate or close up small surface cracks skewing NDT results.

MIC has over five decades of experience engineering shot peening callouts. MIC specializes in the proper selection of shot size and intensity parameters for fatigue and/or corrosion resistant applications. Our worldwide service center locations are listed at the back of this manual.

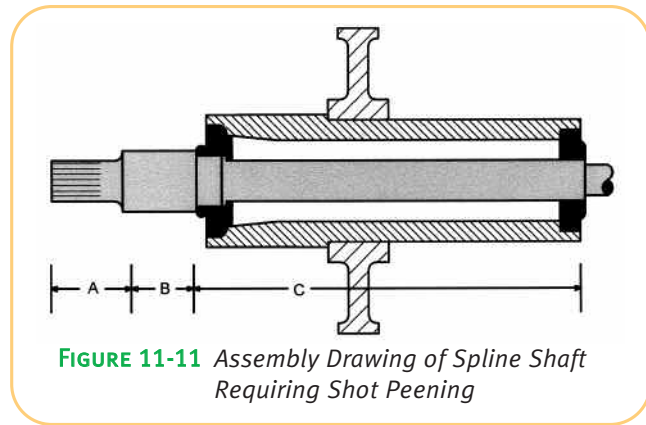

FIGURE 11-11 Assembly Drawing of Spline Shaft Requiring Shot Peening

REFERENCES:

11.1 Internal Metal Improvement Company Memo

PEENSTRESSSM – RESIDUAL STRESS MODELING

When engineering a proper callout for shot peening, Metal Improvement Company (MIC) considers many factors. One of the most important considerations is predicting the residual compressive stress profile after shot peening. The following factors influence the resultant residual stress profile:

- Material, heat treatment and hardness
- Part geometry
- Shot (size, material, hardness and intensity)
- Single peen, dual peen or strain peen

In addition to MIC's over 50 years of experience in selecting proper shot peening parameters, internally developed Peenstresssm software is utilized to optimize shot peening results.

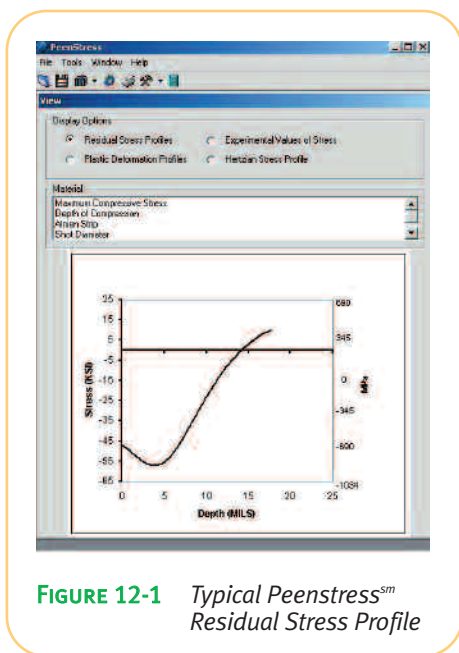

FIGURE 12-1 Typical Peenstresssm Residual Stress Profile

Peenstresssm has an extensive database of materials and heat treatment conditions for the user to choose from. Once the appropriate material (and heat treat condition) is selected, the user then selects shot peening parameters consisting of:

- Shot size
- Shot material and hardness
- Shot intensity

As shown in **FIGURE 12-1**, Peenstresssm graphically plots the theoretical curve based on the user inputs. By altering shot peening parameters the user can optimize the shot peening callout to achieve desired results. Peenstresssm contains a large database of x-ray diffraction data that can be called up to verify the theoretical curves. The program is especially useful when shot peening thin cross sections to determine anticipated depth of compression to minimize the possibility of distortion.

LASER PEENING

MIC developed the laser peening process in conjunction with Lawrence Livermore National Laboratory. The process uses a unique Nd:glass, high output, high repetition laser in conjunction with precision robotic manipulation of the part to be laser peened.

During the laser peening process, the laser is fired at the surface of a metal part to generate pressure pulses of one million pounds per square inch, which send shock waves through the part. Multiple firings of the laser in a pre-defined surface pattern will impart a layer of compressive stress on the surface that is four times deeper than that attainable from conventional peening treatments.



FIGURE 12-2 Laser Peening

The primary benefit of laser peening is a very deep compressive layer with minimal cold working, which increases the component's resistance to failure mechanisms such as fatigue, fretting fatigue and stress corrosion. Compressive stress layer depths of up to 0.040 inches (1.0 mm) on carburized steels and 0.100 inches (2.54 mm) on aluminum and titanium alloys have been achieved. A secondary benefit is that thermal relaxation of the residual stresses of a laser peened surface is less than a shot peened surface due to the reduced cold work that is involved with the process. (Ref 12.1).

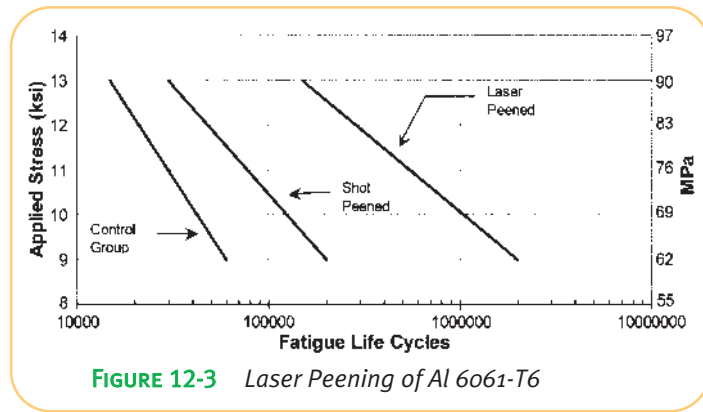

FIGURE 12-3 Laser Peening of Al 6061-T6

The benefits of an exceptionally deep residual compressive layer are shown in **FIGURE 12-3**. The S-N curve shows fatigue test results of a 6061-T6 aluminum. The testing consisted of unpeened, mechanically shot peened and laser peened specimens (Ref 12.2).

MIC currently operates laser peening facilities in the United States and United Kingdom, and offers a mobile laser peening system in order to bring this unique technology directly to customers on site.

COATING SERVICES

Our E/M Coating Services Division has over 40 years of experience in applying critical tolerance coatings and is a pioneer in the development and application of solid film lubricant (SFL) coatings. These coatings are effective in a broad range of applications, whenever conventional wet lubricants provide insufficient protection due to high temperatures, extreme loads, corrosion, wear, chemical corrosion and other adverse operating conditions.

E/M Coating Services can assist you in selecting the right coating to meet your design challenge, lower the cost of ownership or enhance the performance and longevity of your products. Selection of the proper coating can facilitate the use of less expensive metals, improve part wear life and reduce maintenance costs.

Among the different categories of coatings E/M Coating Services applies are:

- Solid Film Lubricants – that protect against adverse operating conditions such as high temperatures, extreme loads, corrosion, wear, galling, seizing, friction, abrasion and chemical corrosion.
- Impingement Coatings – that provide an ultra thin, firmly adherent solid film lubricant.
- Conformal Coatings – for sealing more delicate objects – such as medical devices, satellite components and circuit assemblies – that operate in hostile environments.
- Shielding Coatings – that protect electronic devices from Electro-Magnetic Interference (EMI), Radio Frequency Interference (RFI) and Electro-Static Discharge (ESD).

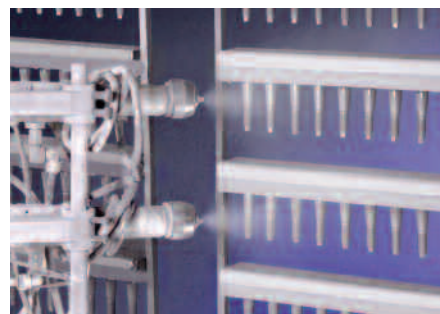

FIGURE 12-4 Coating Services

E/M Coating Services applies all coatings using controlled processes to achieve the highest levels of quality and consistency. Coating engineers and technical service personnel also can help customers determine the right coating process for their application.

HEAT TREATING

Thermal processing relieves stresses within fabricated metal parts and improves their overall strength, ductility and hardness.

MIC specializes in the thermal processing of metal components used in a wide range of industries. Among the numerous thermal processes available through our network of facilities are vacuum heat treating, induction hardening, isothermal annealing and atmosphere normalizing.

MIC's heat treating facilities are located in the Midwest and Eastern U.S. and have capabilities and quality approvals specific to their local customer base. We have the expertise and equipment to handle demanding project requirements and materials that include, but are not limited to:

- Aluminum
- Titanium
- Carbon steels
- Alloy steels
- Cast irons
- Tool steels
- Corrosion resistant steels

Each of our facilities uses programmable controllers that set temperatures and cycle times and monitor the heat treating process to assure a homogenous correctly treated product. Our attention to detail includes an on-going engineering review of the process that assures you the most economical approach with the highest standards of quality and delivery. By involving us at the planning stage of your project, we can use our experience to recommend the optimal alloy and thermal process to meet your design requirements.



FIGURE 12-5 Heat Treating

VALVE REEDS – MANUFACTURING

MIC manufactures valve reeds for use in compressors, pump applications and combustion engines. Valve reeds are precision stampings that operate in demanding environments. Tight manufacturing tolerances are required to achieve flatness and offer resistance to flexing fatigue and high contact loads.

MIC employs Stress-Litesm finishing techniques that are designed to provide specific surface finish and edge rounding requirements for durability. For very demanding applications Stress-Litesm can be combined with shot peening. The following are results comparing valve reed performance using Stress-Litesm with and without shot peening [Ref 12.3]:

- As Stamped: 47,000 cycles
- Stress-Lite: 62,000
- Stress-Lite and Shot Peen: 194,000

FIGURE 12-6 depicts some of the many complex shapes of valve reeds that MIC is capable of manufacturing.

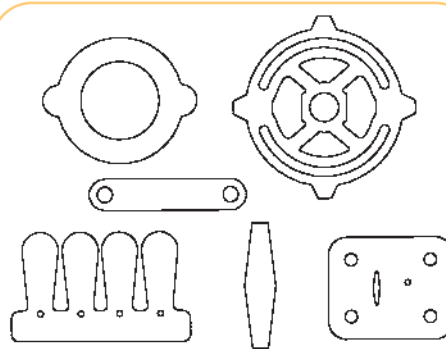

FIGURE 12-6 Valve Reeds

REFERENCES:

- 12.1 Prevey, Hombach, and Mason; *Thermal Residual Stress Relaxation and Distortion in Surface Enhanced Gas Turbine Engine Components*, Proceedings of ASM/TMS Materials Week, September 1997, Indianapolis, IN
- 12.2 Thakkar; *Tower Automotive fatigue study 1999*
- 12.3 Ferrelli, Eckersley; *Using Shot Peening to Multiply the Life of Compressor Components*; 1992 International Compressor Engineering Conference, Purdue University

APPROXIMATE CONVERSION FROM HARDNESS TO TENSILE STRENGTH OF STEELS

<i>Rockwell Hardness</i> HRC	<i>Brinell Hardness</i> BHN	<i>Vickers Hardness</i> HV	<i>Tensile Strength</i> ksi	<i>Tensile Strength</i> MPa
62	688	746	361	2489
61	668	720	349	2406
60	649	697	337	2324
59	631	674	326	2248
58	613	653	315	2172
57	595	633	305	2103
56	577	613	295	2034
55	559	595	286	1972
54	542	577	277	1910
53	525	560	269	1855
52	509	544	261	1800
51	494	528	253	1744
50	480	513	245	1689
49	467	498	238	1641
48	455	484	231	1593
47	444	471	224	1544
46	433	458	217	1496
45	422	446	211	1455
44	411	434	206	1420
43	401	423	201	1386
42	391	412	196	1351
41	381	402	191	1317
40	371	392	186	1282
39	361	382	181	1248
38	352	372	176	1214
37	343	363	171	1179
36	334	354	166	1145
35	325	345	162	1117
34	317	336	158	1089
33	309	327	154	1062
32	301	318	150	1034
31	293	310	146	1007
30	286	302	142	979
29	279	294	138	952
28	272	286	134	924
27	265	279	130	896
26	259	272	127	876
25	253	266	124	855
24	247	260	121	834
23	241	254	118	814
22	235	248	116	800
21	229	243	113	779
20	223	238	111	765

COMMON CONVERSIONS ASSOCIATED WITH SHOT PEENING

	<i>Metric (SI) to English (US Customary)</i>	<i>English to Metric</i>
Length	1 mm = 0.0394 in	1 in = 25.4 mm
	1 m = 3.281 ft = 39.37 in	1 ft = 0.3048 m = 304.8 mm
Area	1 mm ² = 1.550 x 10 ⁻³ in ²	1 in ² = 645.2 mm ²
	1 m ² = 10.76 ft ²	1 ft ² = 92.90 x 10 ⁻³ m ²
Mass	1 kg = 2.205 lbm	1 lbm = 0.454 kg
Force	1 kN = 224.8 lbf	1 lbf = 4.448 N
Stress	1 MPa = 0.145 ksi = 145 lbf/in ²	1 ksi = 6.895 MPa

MISCELLANEOUS TERMS & CONSTANTS

lbm = lb (mass)

lbf = lb (force)

k = kilo = 10³

M = mega = 10⁶

G = giga = 10⁹

μ = micro = 10⁻⁶

1 Pa = 1 N/m²

lbf/in² = psi

ksi = 1000 psi

μm = micron = 1/1000 mm

Young's Modulus (E) for Steel = 29 x 10⁶ lbf/in² = 200 GPa

Acceleration of Gravity = 32.17 ft/s² = 9.81 m/s²

Density of Steel = 0.283 lbm/in³ = 7.832 x 10⁻⁶ kg/mm³

TECHNICAL ARTICLE REPRINTS

Metal Improvement Company has on file a large collection of technical resources pertaining to metal fatigue, corrosion and shot peening. Many of the reprints that are available are listed below. Please contact your local service center or visit our website www.metalimprovement.com for other specific information on shot peening and our other metal treatment services.

1. "Shot Peening of Engine Components"; J. L. Wandell, Metal Improvement Company, Paper N^o 97 ICE-45, ASME 1997.
2. "The Application of Microstructural Fracture Mechanics to Various Metal Surface States"; K. J. Miller and R. Akid, University of Sheffield, UK.
3. "Development of a Fracture Mechanics Methodology to Assess the Competing Mechanisms of Beneficial Residual Stress and Detrimental Plastic Strain Due to Shot Peening"; M. K. Tufft, General Electric Company, International Conference on Shot Peening 6, 1996.
4. "The Significance of Almen Intensity for the Generation of Shot Peening Residual Stresses"; R. Hertzog, W. Zinn, B. Scholtes, Braunschweig University and H. Wohlfahrt, University GH Kassel, Germany.
5. "Computer Monitored Shot Peening: AMEC Writes New AMS Specification"; Impact: Review of Shot Peening Technology, Metal Improvement Company, 1988.
6. "Three Dimensional Dynamic Finite Element Analysis of Shot-Peening Induced Residual Stresses"; S. A. Meguid, G. Shagal and J. C. Stranart, University of Toronto, Canada, and J. Daly, Metal Improvement Company.
7. "Instrumented Single Particle Impact Tests Using Production Shot: The Role of Velocity, Incidence Angle and Shot Size on Impact Response, Induced Plastic Strain and Life Behavior"; M. K. Tufft, GE Aircraft Engines, Cincinnati, OH., 1996.
8. "Predicting of the Residual Stress Field Created by Internal Peening of Nickel-Based Alloy Tubes"; N. Hamdane, G. Inglebert and L. Castex, Ecole Nationale Supérieure d'Arts et Métiers, France.
9. "Three Innovations Advance the Science of Shot Peening"; J. S. Eckersley and T. J. Meister, Metal Improvement Company, Technical Paper, AGMA, 1997.
10. "Tech Report: Surface Integrity"; Manufacturing Engineering, 1989.
11. "Optimization of Spring Performance Through Understanding and Application of Residual Stresses"; D. Hornbach, Lambda Research Inc., E. Lanke, Wisconsin Coil Spring Inc., D. Breuer, Metal Improvement Company.
12. "Plastically Deformed Depth in Shot Peened Magnesium Alloys"; W. T. Ebihara, U. S. Army, N. F. Fiore and M. A. Angelini, University of Notre Dame.
13. "Improving the Fatigue Crack Resistance of 2024-T351 Aluminium Alloy by Shot Peening"; E. R. del Rios, University of Sheffield, and M. Trooll and A. Levers, British Aerospace Airbus, England.
14. "Fatigue Crack Initiation and Propagation on Shot-Peened Surfaces in a 316 Stainless Steel"; E. R. del Rios, A. Walley and M. T. Milan, University of Sheffield, England, and G. Hammersley, Metal Improvement Company.
15. "Characterization of the Defect Depth Profile of Shot Peened Steels by Transmission Electron Microscopy"; U. Martin, H. Oettel, Freiberg University of Mining and Technology, and I. Altenberger, B. Scholtes and K. Kramer, University Gh Kassel, Germany.
16. "Essais Turbomeca Relatifs au Grenillage de l'Alliage Base Titane TA6V"; A. Bertoli, Turbomeca, France.
17. "Effect of Microstrains and Particle Size on the Fatigue Properties of Steel"; W. P. Evans and J. F. Millan, The Shot Peener, Vol. II, Issue 4.
18. "Overcoming Detrimental Residual Stresses in Titanium by the Shot Peening Process"; T. J. Meister, Metal Improvement Company.
19. "The Effect of Shot Peening on Calculated Hydrogen Surface Coverage of AISI 4130 Steel"; I. Chattoraj, National Metallurgical Laboratory, Jamshedpur, India, and B. E. Wilde, The Ohio State University, Columbus, OH. Pergamon Press plc, 1992.
20. "Effect of Shot Peening on Delayed Fracture of Carburized Steel"; N. Hasegawa, Gifu University, and Y. Watanabe, Toyo Seiko Co. Ltd., Japan.

21. "New Studies May Help an Old Problem. Shot Peening: an Answer to Hydrogen Embrittlement?"; J. L. Wandell, Metal Improvement Company.
22. "The Effects of Shot Peening on the Fatigue Behaviour of the Ni-base Single Crystal Superalloy CMSX-4"; J. Hou and W. Wei, University of Twente, Netherlands.
23. "Effect of Shot Peening Parameters on Fatigue Influencing Factors"; A. Niku-Lari, IITT, France.
24. "Weld Fatigue Life Improvement Techniques" (Book); Ship Structure Committee, Robert C. North, Rear Admiral, U. S. Coast Guard, Chairman.
25. "Controlled Shot Peening as a Pre-Treatment of Electroless Nickel Plating"; G. Nickel, Metal Improvement Company, Electroless Nickel '95.
26. "Effects of Surface Condition on the Bending Strength of Carburized Gear Teeth"; K. Inoue and M. Kato, Tohoku University, Japan, S. Lyu, Chonbuk National University, Republic of Korea, M. Onishi and K. Shimoda, Toyota Motor Corporation, Japan, 1994 International Gearing Conference.
27. "Aircraft Applications for the Controlled Shot Peening Process"; R. Kleppe, MIC, Airframe/Engine Maintenance and Repair Conference and Exposition, Canada, 1997.
28. "Prediction of the Improvement in Fatigue Life of Weld Joints Due to Grinding, TIG Dressing, Weld Shape Control and Shot Peening"; P. J. Haagensen, The Norwegian Institute of Technology, A. Drigen, T Slind and J. Orjaseter, SINTEF, Norway.
29. "Increasing Fatigue Strength of Weld Repaired Rotating Elements"; W. Welsch, Metal Improvement Company.
30. "B 737 Horizontal Stabilizer Modification and Repair"; Alan McGreal, British Airways and Roger Thompson, Metal Improvement Company.
31. "Residual Stress Characterization of Welds Using X-Ray Diffraction Techniques"; J. A. Pinault and M. E. Brauss, Proto Manufacturing Ltd., Canada and J. S. Eckersley, Metal Improvement Company.
32. "Towards a Better Fatigue Strength of Welded Structures"; A. Bignonnet, Fatigue Design, Mechanical Engineering Publications, London, England.
33. "ABB Bogie Shot-Peening Demonstration: Determination of Residual Stresses in a Weld With and Without Shot-Peening"; P. S. Whitehead, Stresscraft Limited, England.
34. "The Application of Controlled Shot Peening as a Means of Improving the Fatigue Life of Intramedullary Nails Used in the Fixation of Tibia Fractures"; M. D. Schafer, State University of New York at Buffalo.
35. "Improvement in the Fatigue Life of Titanium Alloys"; L. Wagner and J. K. Gregory, Advanced Materials and Processes, 1997.
36. "Effet du Grenailage sur la Tenue en Fatigue Vibratoire du TA6V"; J. Y. Guedou, S.N.E.C.M.A., France.
37. "Fretting Fatigue and Shot Peening"; A. Bignonnet et al., International Conference of Fretting Fatigue, Sheffield, England, 1993.
38. "Influence of Shot Peening on the Fatigue of Sintered Steels under Constant and Variable Amplitude Loading"; C. M. Sonsino and M. Koch, Darmstadt, Germany.
39. "Evaluation of the Role of Shot Peening and Aging Treatments on Residual Stresses and Fatigue Life of an Aluminum Alloy"; H. Allison, Virginia Polytechnic Institute, VA.
40. "A Survey of Surface Treatments to Improve Fretting Fatigue Resistance of Ti-6Al-4V"; I. Xue, A. K. Koul, W. Wallace and M. Islam, National Research Council, and M. Bibby, Carlton University, Canada, 1995.
41. "Gearing Up For Higher Loads"; Impact - Review of Shot Peening Technology, Metal Improvement Company.
42. "Belleville Disk Springs"; Product News, Power Transmission Design, 1996.
43. "Improvement in Surface Fatigue Life of Hardened Gears by High-Intensity Shot Peening"; D. P. Townsend, Lewis Research Center, NASA, Sixth International Power Transmission Conference, 1992.
44. "Review of Canadian Aeronautical Fatigue Work 1993-1995"; D. L. Simpson, Institute for Aerospace Research, National Research Council of Canada.

45. "A Review of Australian and New Zealand Investigations on Aeronautical Fatigue During the Period of April 1993 to March 1995"; J. M. Grandage and G. S. Jost, editors, Department of Defense, Australia and New Zealand.
46. "Shot Peening to Increase Fatigue Life and Retard Stress Corrosion Cracking"; P. Dixon Jr., Materials Week, American Society for Metals, 1993.
47. "The Effect of Hole Drilling on Fatigue and Residual Stress Properties of Shot-Peened Aluminum Panels"; J. Chadhuri, B. S. Donley, V. Gondhalekar, and K. M. Patni, Journal of Materials Engineering and Performance, 1994.
48. "Shot Peening, a Solution to Vibration Fatigue"; J. L. Wandell, Metal Improvement Company, 19th Annual Meeting of The Vibration Institute, USA, 1995.
49. "GE Dovetail Stress Corrosion Cracking Experience and Repair"; C. DeCesare, S. Koenders, D. Lessard and J. Nolan, General Electric Company, Schenectady, New York.
50. "Arresting Corrosion Cracks in Steam Turbine Rotors"; R. Chetwynd, Southern California Edison.
51. "Rotor Dovetail Shot Peening"; A. Morson, Turbine Technology Department, General Electric Company, Schenectady, NY.
52. "Stress Corrosion Cracking: Prevention and Cure"; Impact - Review of Shot Peening Technology, Metal Improvement Company, 1989.
53. "The Application for Controlled Shot Peening for the Prevention of Stress Corrosion Cracking (SCC)"; J. Daly, Metal Improvement Company, NACE Above Ground Storage Tank Conference, 1996.
54. "The Use of Shot Peening to Delay Stress Corrosion Crack Initiation on Austenitic 8Mn8Ni4Cr Generator End Ring Steel"; G. Wigmore and L. Miles, Central Electricity Generating Board, Bristol, England.
55. "Steam Generator Shot Peening"; B&W Nuclear Service Company, Presentation for Public Service Electric & Gas Company, 1991.
56. "The Prevention of Stress Corrosion Cracking by the Application of Controlled Shot Peening"; P. O'Hara, Metal Improvement Company.
57. "Designing Components Made of High Strength Steel to Resist Stress Corrosion Cracking Through the Application of Controlled Shot Peening"; M. D. Shafer, Department of Mechanical Engineering, Buffalo, NY, The Shot Peener, Volume 9, Issue 6.
58. "Shot Peening for the Prevention of Stress Corrosion and Fatigue Cracking of Heat Exchangers and Feedwater Heaters"; C. P. Diepart, Metal Improvement Company.
59. "Shot Peening: a Prevention to Stress Corrosion Cracking – a Case Study"; S. Clare and J. Wolstenholme
60. "Thermal Residual Stress Relaxation and Distortion in Surface Enhanced Gas Turbine Engine Components"; P. Prevey, D. Hornbach and P. Mason, Lambda Research, AMS Materials Week, 1997.
61. "EDF Feedback Shot-Peening on Feedwater Plants Working to 360 °C – Prediction Correlation and Follow-up of Thermal Stresses Relaxation"; J. P. Gauchet, EDF, J. Barrallier, ENSAM, Y. LeGuernic, Metal Improvement Company, France.
62. "EDF Feedback on French Feedwater Plants Repaired by Shot Peening and Thermal Stresses Relaxation Follow-up"; J. P. Gauchet and C. Reversat, EDF, Y. LeGuernic, Metal Improvement Company, J. L. LeBrun, LM# URA CNRS 1219, L. Castex and L. Barrallier, ENSAM, France.
63. "Effect of Small Artificial Defects and Shot Peening on the Fatigue Strength of Ti-Al-4V Alloys at Elevated Temperatures"; Y. Kato, S. Takafuji and N. Hasegawa, Gifu University, Japan.
64. "Investigation on the Effect of Shot Peening on the Elevated Temperature Fatigue Behavior of Superalloy"; C. Yaoming and W. Renzhi, Institute of Aeronautical Materials, Beijing, China.
65. "Effect of Shot Peening and Post-Peening Heat Treatments on the Microstructure, the Residual Stresses and Deuterium Uptake Resistance of Zr-2.5Nb Pressure Tube Material"; K. F. Amouzouvi, et al, AECL Research, Canada.
66. "Transmission Components, Gears – CASE Finishing"; Metal Improvement Company.
67. "Steam Generator Peening Techniques"; G. M. Taylor, Nuclear News, 1987.
68. "Shot Peening Versus Laser Shock Processing"; G. Banas, F.V. Lawrence Jr., University of Illinois, IL.

69. "Lasers Apply Shock for Strength"; J. Daly, Metal Improvement Company, The Update, Page 6, Ballistic Missile Defense Organization, 1997.
70. "Surface Modifications by Means of Laser Melting Combined with Shot Peening: a Novel Approach"; J. Noordhuis and J. TH. M. De Hosson, Acta Metall Mater Vol. 40, Pergamon Press, UK.
71. "Laser Shock Processing of Aluminium Alloys. Application to High Cycle Fatigue Behaviour"; P. Peyre, R. Fabro, P. Merrien, H. P. Lieurade, Materials Science and Engineering, Elsevier Science S.A. 1996, UK.
72. "Laser Peening of Metals – Enabling Laser Technology"; C. B. Dane and L. A. Hackel, Lawrence Livermore National Laboratory, and J. Daly and J. Harrison, Metal Improvement Company.
73. "Laser Induced Shock Waves as Surface Treatment of 7075-T7351 Aluminium Alloy"; P. Peyre, P. Merrien, H. P. Lieurade, and R. Fabbro, Surface Engineering, 1995.
74. "Effect of Laser Surface Hardening on Permeability of Hydrogen Through 1045 Steel"; H. Skrzypek, Surface Engineering, 1996.
75. "Stop Heat from Cracking Brake Drums"; Managers Digest, Construction Equipment, 1995.
76. "The Ultra-Precision Flappers... Shot Peening of Very Thin Parts"; Valve Division, Impact – a Review of Shot Peening Technology, Metal Improvement Company, 1994.
77. "The Aging Aircraft Fleet: Shot Peening Plays a Major Role in the Rejuvenation Process"; Impact – Review of Shot Peening Technology, Metal Improvement Company.
78. "Sterilization and Sanitation of Polished and Shot-Peened Stainless-Steel Surfaces"; D. J. N. Hossack and F. J. Hooker, Huntingdon Research Centre, Ltd., England.
79. "Shot Peening Parameters Selection Assisted by Peenstress Software"; Y. LeGuernic, Metal Improvement Company.
80. "Process Controls: the Key to Reliability of Shot Peening"; J. Mogul and C. P. Diepart, Metal Improvement Company, Industrial Heating, 1995.
81. "Innovations in Controlled Shot Peening"; J. L. Wandell, Metal Improvement Company, Springs, 1998.
82. "Computer Monitored Shot Peening, an Update"; J. R. Harrison, Metal Improvement Company, 1996 USAF Aircraft Structural Integrity Conference.
83. "Shot Peening of Aircraft Components – NAVAIR Instruction 4870.2"; Naval Air System Command, Department of the Navy, USA.
84. "A Review of Computer-Enhanced Shot Peening"; J. Daly and J. Mogul, Metal Improvement Company, The Joint Europe-USA Seminar on Shot Peening, USA, 1992.
85. "Shot Peening – Process Controls, the Key to Reliability"; J. Mogul and C. P. Diepart, Metal Improvement Company.
86. "The Implementation of SPC for the Shot Peening Process"; Page 15, Quality Breakthrough, a Publication for Boeing Suppliers, 1993.
87. "Peenstress Software Selects Shot Peening Parameters"; Y. LeGuernic and J. S. Eckersley, Metal Improvement Company.
88. "The Development of New Type Almen Strip for Measurement of Peening Intensity on Hard Shot Peening"; Y. Watanabe et al, Gifu University, Japan.
89. "Interactive Shot Peening Control"; D. Kirk, International Conference on Shot Peening 5, 1993.
90. "Shot Peening: Techniques and Applications"; (Book) K. J. Marsh, Editor, Engineering Materials Advisory Services Ltd., England.
91. "Evaluation of Welding Residual Stress Levels Through Shot Peening and Heat Treating"; M. Molzen, Metal Improvement Company, D. Hornbach, Lambda Research, Inc.
92. "Effect of Shot Peening of Stress Corrosion Cracking on Austenitic Stainless Steel"; J. Kritzler, Metal Improvement Company.
93. "An Analytical Comparison of Atmosphere and Vacuum Carburizing Using Residual Stress and Microhardness Measurements"; D. Breuer, Metal Improvement Company, D. Herring, The Herring Group, Inc., G. Lindell, Twin Disc, Inc., B. Matlock, TEC, Inc.

94. "Strengthening of Ceramics by Shot Peening"; Pfeiffer, W. & Frey, T., Materials Science Forum, 2002.
95. "Strength Gained from Shot Peening of Case Hardened Gears"; SAA Specification STD 3997, 1999-2002.
96. "Shot Peening of Fillet Welded Closed and Open Faced Turbo Com Impellers"; Dresser-Rand Turbo Products Spec. 015-008, Draft 4/01.
97. "Fatigue Crack Growth in Residual Stress Fields"; Wang, J., Schneider, G. and Vertergaard, L., American Helicopter Society Conference, May 2001.
98. "Optimized Carburized Steel Fatigue Performance as Assessed with Gear and Modified Brugger Fatigue Tests"; Spice, J. and Matlock, D., SAE #2002-01-1003.
99. "Maintenance of High-Strength Alloy Steel Components"; Dickerson, C. and Garber, R., Aero Magazine, April 2003.
100. "The Effect of Shot Peening on the Resistance of Zeron 100 to Hydrogen Embrittlement"; Francis, R., #TN 1356, July 2000.
101. "Bending Fatigue of Carburized Steels"; Wise, J., Matlock, D. and Krauss, G., Heat Treating Progress, August 2001.
102. "Inspecting Welds to Improve Fatigue Life"; Anderson, T., Practical Welding Today, June 2002.
103. "Repair and Life Assessment of Critical Fatigue Damaged Aluminum Alloy Structure Using a Peening Rework Method"; Barter, S., Molent, L., Sharp, K. and Clark, G., USAF ASIP Conference, 2001.
104. "Controlled Shot Peening: Improvements in Fatigue Life and Fatigue Characteristics of Powder Metallurgical Components"; Gray, K.
105. "Fatigue Life Curves Comparing a Wrought Steel to a Powdered Metal With and Without Shot Peening"; Strehl, R., 2001.
106. "Fatigue Damage Mechanism and Stress Relaxation in Shot Peened and Polished Nickel Base Materials"; Belassel, M., Brauss, M., Pineault, J. and Berkley, S., Materials Science Forum, 2002.
107. "X-Ray Diffraction Data on Shot Peened Components"; Breuer, D., 3/6/00.
108. "Automated Surface and Subsurface Residual Stress Measurement for Quality Assurance of Shot Peening"; Diffraction Notes, Spring, 2001.
109. "Residual Stress Stability and Alternating Bending Strength of AISI 4140 after Shot Peening and Successive Annealing"; Menig, R., Schulze, V. and Vohringer, O., Materials Science Forum, 2002.
110. "Utilization of Powdered Metal and Shot Peening Residual Stress to Maximize Cost and Performance Benefit of High Load Gearing"; Breuer, D., ASME, Sept. 2003.
111. "Impact of isotropic superfinishing on contact and bending fatigue of carburized Steel"; Winkelmann, L., Michaud, M., Sroka, G. and Swiglo, A., SAE Technical Paper 2002-01-1391, March 2002.
112. "Pitting Resistance Improvement Through Shot Peening – Renault Experience"; LeGuernic, Y., Jan. 2001.
113. "Surface Fatigue Lives of Case-Carburized Gears with an Improved Surface Finish"; Krantz, T., Alauou, M., Evans, H. and Snidle, R., NASA/TM-2000-210044, April 2000.
114. "Improving Gear Performance by Enhancing the Fatigue Properties of Steel"; British Gear Association Final Report, Oct. 2002.
115. "Atmosphere vs. Vacuum Carburizing, Heat Treating Progress", plus Presentation for ASM and SAE Metallurgy; Lindell, G., Herring, D., Breuer, D. and Matlock, B., Nov. 2001.
116. "Shot Peen Forming of New _-Dome Tank Segments for ARIANE 5"; Wustefeld, F., Metal Finishing News, Nov. 2002.
117. "Improvement of Fatigue Strength of Nitrided High-Strength Valve Springs by Application of a New Super Fine Shot Peening Technology"; Yamada, Y., et al, SAE Tech Paper 2002-02-0834, 2001.
118. "Development of Shot Peening for Wing Integral Skin for Continental Business Jets"; Yamada, T., Ikeda, M., Ohta, T., Takahashi, T. and Sugimoto, S., Mitsubishi Heavy Industries Ltd., 2002.
119. "Cracking Down on Cracking (Environmental Cracking of Carbon Steel)"; Shargay, C., Chemical Processing, May 2000.

120. "Evaluation of Welding Residual Stress Levels Through Shot Peening and Heat Treating"; Molzen, M. and Hornbach, D., SAE Technical Paper #2000-01-25664, Sept. 2000.
121. "Selecting the Best Carburizing Method for the Heat Treatment of Gears"; Breuer, D., Lindell, G. and Herring, D., 2003.
122. "Suitability of High Density Powder Metal Gears for Gear Applications"; Link, R. and Kotthoff, G., Gear Technology, Jan/Feb. 2001.
123. "Subsurface Properties of Laser Peened 6061-T6 Al Weldments"; Montross, C., Florea, V., Brandt, M. and Swain, M., Surface Engineering 2000.
124. "Laser Shock Processing"; Van Aken, D., Industrial Heating, Feb. 2001.
125. "The Effects of Process Variations on Residual Stress Induced by Laser Peening"; Hackel, L., Harris, F., Halpin, J., Rankin, J., Hill, M. and Chen, H., Materials Science Forum, 2002.
126. "Laser Shock Peening Solves Many Performance Issues"; Reitz, W., Surface Engineering, Feb. 2002.
127. "Process Control Techniques for Laser Peening of Metals"; Specht, R., Jones, D., Hackel, L., Harris, F., Hill, M., Halpin, J., Lane, L., Zaleski, T. and Wubbenhorst, W., 2002.
128. "Laser Peening Technology"; Hill, M., DeWald, A., Demma, A., Hackel, L., Chen, H-L, Dane, C., Specht, R., and Harris, F., Advanced Materials and Processes, Aug. 2003.
129. "Fatigue of Mechanically Surface Treated Materials at Elevated Temperatures"; Altenberger, I., Noster, U., Scholtes, B. and Ritchie, R., 2002.
130. "The Affects of Shot and Laser Peening on Crack Growth and Fatigue Life in 2024 Aluminum Alloy and 4340 Steel"; Everett, R., Matthews, W., Probhakaran, R., Newman, J. and Dubberly, M., USAF Structural Integrity Program Conference, 2000.

GLOBAL HEADQUARTERS

Metal Improvement Company
10 Forest Avenue
Paramus, NJ 07652 USA
Tel: 201-843-7800
Fax: 201-843-3460
E-mail: info@metalimprovement.com

EUROPEAN CORPORATE OFFICE

Metal Improvement Company
Hambridge Lane
Newbury, Berkshire RG14 5TU
England
Tel: +44 (0) 1635-279621
Fax: +44 (0) 1635-279629
E-mail: eurosales@metalimprovement.com

SHOT PEENING**UNITED STATES**

ARIZONA
103 S. 41st. Avenue
Phoenix, AZ 85009
Tel: 602-278-2811
Fax: 602-278-3911
E-mail: phoenix-shotpeen@metalimprovement.com

CALIFORNIA
3239 East 46th Street
Vernon, CA 90058
Tel: 323-585-2168
Fax: 323-585-0157
E-mail: vernon-shotpeen@metalimprovement.com

2151 South Hathaway
Santa Ana, CA 92705
Tel: 714-546-4160
Fax: 714-546-8643
E-mail: santaana-shotpeen@metalimprovement.com

2588-A Industry Way
Lynwood, CA 90262
Tel: 323-563-1533
Fax: 323-563-2105
E-mail: lynwood-shotpeen@metalimprovement.com

CONNECTICUT
145 Addison Road
Windsor, CT 06095
Tel: 860-688-6201
Fax: 860-285-8809
E-mail: windsor-shotpeen@metalimprovement.com

FLORIDA
1940 N.W. 70th Avenue
Miami, FL 33126
Tel: 305-592-5960
Fax: 305-477-9648
E-mail: miami-shotpeen@metalimprovement.com

ILLINOIS
678 W. Winthrop Avenue
Addison, IL 60101
Tel: 630-543-4950
Fax: 630-543-8075
E-mail: chicago-shotpeen@metalimprovement.com

INDIANA
5945 W. 84th Street
Suite D
Indianapolis, IN 46278
Tel: 317-875-6030
Fax: 317-875-6044
E-mail: indianapolis-shotpeen@metalimprovement.com

KANSAS
440 North West Road
Wellington, KS 67152
Tel: 620-326-5509
Fax: 620-326-6043
E-mail: wellington-shotpeen@metalimprovement.com

LOUISIANA
116 Southpark Road
Lafayette, LA 70508
Tel: 337-837-9273
Fax: 337-837-2505
E-mail: lafayette-shotpeen@metalimprovement.com

MASSACHUSETTS
One Nablus Road
Wakefield, MA 01880
Tel: 781-246-3848
Fax: 781-246-4521
E-mail: wakefield-shotpeen@metalimprovement.com

MICHIGAN
30100 Cypress Drive
Romulus, MI 48174
Tel: 734-728-8600
Fax: 734-729-8605
E-mail: romulus-shotpeen@metalimprovement.com

3850 Howe Road
Wayne, MI 48184
Tel: 734-729-4500
Fax: 734-729-5556
E-mail: AMP-shotpeen@metalimprovement.com

MINNESOTA
8630-A Monticello Lane
Maple Grove, MN 55369
Tel: 763-425-2400
Fax: 763-425-4669
E-mail: minneapolis-shotpeen@metalimprovement.com

NEW YORK
195 Field Street
W. Babylon, NY 11704
Tel: 631-694-8770
Fax: 631-694-8775
E-mail: longisland-shotpeen@metalimprovement.com

NORTH CAROLINA
500 Spring Brook Road
Charlotte, NC 28217
Tel: 704-525-3818
Fax: 704-525-3118
E-mail: charlotte-shotpeen@metalimprovement.com

OHIO
11131 Luscek Drive
Blue Ash, OH 45241
Tel: 513-489-6484
Fax: 513-489-6499
E-mail: cincinnati-shotpeen@metalimprovement.com

1652 East Highland Road
Twinsburg, OH 44087
Tel: 330-425-1490
Fax: 330-425-1494
E-mail: cleveland-shotpeen@metalimprovement.com

PENNSYLVANIA
3434 State Road
Bensalem, PA 19020
Tel: 215-638-0888
Fax: 215-638-2885
E-mail: bensalem-shotpeen@metalimprovement.com

TEXAS
1450 Avenue S.
Grand Prairie, TX 75050
Tel: 972-641-8011
Fax: 972-660-3692
E-mail: dallas-shotpeen@metalimprovement.com

9410 East Hardy
Houston, TX 77093
Tel: 713-691-0257
Fax: 713-691-4744
E-mail: houston-shotpeen@metalimprovement.com

WISCONSIN
8201 North 87th Street
Milwaukee, WI 53224
Tel: 414-355-6119
Fax: 414-355-9114
E-mail: milwaukee-shotpeen@metalimprovement.com

CANADA

105 Alfred Kuehne Blvd.
Brampton, Ontario
Canada L6T 4K3
Tel: 905-791-8002
Fax: 905-791-4490
E-mail: toronto@metalimprovement.com

UNITED KINGDOM

Ascot Drive
Derby DE24 8ST
England
Tel: +44 (0) 1332-756076
Fax: +44 (0) 1332-758387
E-mail: micderby@metalimprovement.com

Hambridge Lane
Newbury, Berkshire RG14 5TU
England
Tel: +44 (0) 1635-279600
Fax: +44 (0) 1635-279601
E-mail: micnewbury@metalimprovement.com

Hawarden Airport
Chester Road
Broughton, Chester CH4 0BZ
England
Tel: +44 (0) 1244-534999
Fax: +44 (0) 1244-521500
E-mail: micchester@metalimprovement.com

37 Central Way
Pallion Industrial Estate
Sunderland
Tyne and Wear SR4 6SN
England
Tel: +44 (0) 1915 141140
Fax: +44 (0) 1915-141124
E-mail: micsunderland@metalimprovement.com

SWEDEN

Ytstruktur Arboga AB
Asby Industriområde
732 47 Arboga
Sweden
Tel: +46-589-828-88
Fax: +46-589-825-01
E-mail: ytstruktur@metalimprovement.com

FRANCE

Zone Industrielle D'Amilly
45200 Montargis
France
Tel: +33-2-38-85-58-07
Fax: +33-2-38-98-33-76
E-mail: micmontargis@metalimprovement.com

Zone Industrielle de St. Etienne
Rue De Cazenave
64100 Bayonne
France
Tel: +33-5-59-55-42-52
Fax: +33-5-59-55-65-67
E-mail: micbayonne@metalimprovement.com

SHOT PEENING (continued)**ITALY**

Via P. Belizzi
29100 Piacenza
Italy
Tel: +39-0523-590568
Fax: +39-0523-603621
E-mail: micpiacenza@
metalimprovement.com

GERMANY

Otto-Hahn Strasse 3
59423 Unna
Germany
Tel: +49-2303-9188-0
Fax: +49-2303-9188-11
E-mail: micunna@
metalimprovement.com

Sommerauer Strasse 6
D-91555 Feuchtwangen
Germany
Tel: +49-9852-6703-0
Fax: +49-9852-6703-11
E-mail: micfeuchtwangen@
metalimprovement.com

Hans-Böckler-Str. 5
64521 Gross-Gerau
Germany
Tel: +49-6152-8577-0
Fax: +49-6152-8577-11
E-mail: micgrosserau@
metalimprovement.com

Niederlassung Brandenburg
Am Piperfenn 7a
14776 Brandenburg
Germany
Tel: +49-3381-79374-0
Fax: +49-3381-79374-11
E-mail: micbrandenburg@
metalimprovement.com

BELGIUM

Schurhovenveld 4056
B-3800 Sint-Truiden
Belgium
Tel: +32-11-69-65-12
Fax: +32-11-69-65-14
E-mail: micsttruiden@
metalimprovement.com

LASER PEENING**UNITED STATES**

CALIFORNIA
7655 Longard Road
Livermore, CA 94551
Tel: 925-960-1090
Fax: 925-960-1093
E-mail: laserpeen@
metalimprovement.com

UNITED KINGDOM

Barnoldswick
West Craven Drive
West Craven Business Park
Earby, Lancashire BB18 6JZ
England
Tel: +44 (0) 1282-843350
Fax: +44 (0) 1282-844626
E-mail: micearby@
metalimprovement.com

COATING SERVICES**UNITED STATES**

CALIFORNIA
E/M Coating Services
20751 Superior Street
Chatsworth, CA 91311
Tel: 818-407-6280
Fax: 818-407-6288
E-mail: losangeles-em@
metalimprovement.com

E/M Coating Services
6940 Farmdale Avenue
North Hollywood, CA 91605
Tel: 818-983-1952
Fax: 818-503-0998
E-mail: losangeles-
em@metalimprovement.com

CONNECTICUT

E/M Coating Services
1 John Downey Drive
New Britain, CT 06051
Tel: 860-224-9148
Fax: 860-224-6572
E-mail: hartford-em@
metalimprovement.com

ILLINOIS

E/M Coating Services
129 South Eisenhower Lane
Lombard, IL 60148
Tel: 630-620-6808
Fax: 630-620-6911
E-mail: chicago-em@
metalimprovement.com

MICHIGAN

E/M Coating Services
14830 23 Mile Road
Shelby, MI 48315
Tel: 586-566-6800
Fax: 586-566-5900
E-mail: detroit-em@
metalimprovement.com

MINNESOTA

E/M Coating Services
2172 Old Highway 8
New Brighton, MN 55112
Tel: 651-780-3202
Fax: 651-780-3252
E-mail: minneapolis-em@
metalimprovement.com

PENNSYLVANIA

MIC Bensalem Finishing
3434 State Road
Bensalem, PA 19020
Tel: 215-638-0888
Fax: 215-638-2885
E-mail: bensalem-finishing@
metalimprovement.com

UNITED KINGDOM

E/M Coating Services
Enterprise Way
Vale Industrial Park
Evesham, Worcestershire WR11 1GX
England
Tel: +44 (0) 1386-421444
Fax: +44 (0) 1386-765410
E-mail: emenquiries@
metalimprovement.com

HEAT TREATING**UNITED STATES**

INDIANA
3715 East Washington Blvd.
Fort Wayne, IN 46803
Tel: 260-423-1691
Fax: 260-422-2656
E-mail: fortwayne-heatreat@
metalimprovement.com

KANSAS
1019 South McLean Blvd.
Wichita, KS 67213
Tel: 316-267-0239
Fax: 316-267-7904
E-mail: wichitamclean-heatreat@
metalimprovement.com

1618 Ida
Wichita, KS 67211
Tel: 316-267-8201
Fax: 316-267-5735
E-mail: wichitaida@
metalimprovement.com

1009 South West Street
Wichita, KS 67213
Tel: 316-943-3288
Fax: 316-943-3025
E-mail: wichitawest-heatreat@
metalimprovement.com

LOUISIANA

116 Southpark Road
Lafayette, LA 70508
Tel: 337-837-9273
Fax: 337-837-2505
E-mail: lafayette-heatreat@
metalimprovement.com

NEW JERSEY

304 Cox Street
Roselle, NJ 07203
Tel: 908-245-0717
Fax: 908-245-6255
E-mail: roselle-ironbound@
metalimprovement.com

OHIO

431 West Wilson Street
Salem, OH 44460
Tel: 330-337-7671
Fax: 330-337-6074
E-mail: salem-heatreat@
metalimprovement.com

1515 Universal Road
Columbus, OH 43207
Tel: 614-444-1181
Fax: 614-444-0421
E-mail: columbus-heatreat@
metalimprovement.com

PENNSYLVANIA

270 Emig Road
Emigsville, PA 17318
Tel: 717-767-6757
Fax: 717-764-0129
E-mail: york-heatreat@
metalimprovement.com

VALVE REED MANUFACTURE**UNITED STATES**

CONNECTICUT
Precision Stampings
98 Filley Street
Bloomfield, CT 06002
Tel: 860-243-2220
Fax: 860-242-7292
E-mail: bloomfield-finishing@
metalimprovement.com

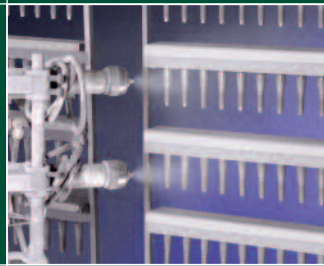
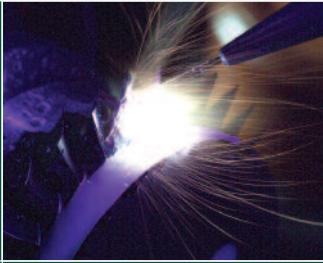

Metal Improvement Company
10 Forest Avenue
Paramus, NJ 07652 USA

Ph: 201-843-7800 Fax: 201-843-3460
E-mail: info@metalimprovement.com
Web: www.metalimprovement.com

A subsidiary of Curtiss-Wright Corporation



Curtiss-Wright is a diversified global provider of highly engineered products and services for the metal treatment, flow control and motion control markets. Visit www.curtisswright.com