



IGNITER BM4 / BR4 – Ignites just about anything.

The new IGNITER ignition blower from Leister has been specially developed for installation into pellet and wood chip boilers. The IGNITER BR4 with 3.4 kW has what it takes. The interface was selected so that the ignition blowers can easily be installed into any heating boiler.

New

1		<p>Easy: Connector plug located directly on the device means easy removal and installation and fewer device configurations.</p>
2		<p>Clever: New assembly support for positioning in the furnace.</p>
3		<p>Linked: Connection adapter for air hose located directly on the device with inner 1" thread (no extra accessories needed).</p>
4		<p>Additional: Pipe joint adapter with M14 thread for easy adaptation of the heat conduction lines and extensions (available only for IGNITER BM4).</p>
5		<p>Protected: Heating element protection with phototransistor and device protection via temperature protection circuit.</p>



reddot design award
winner 2013

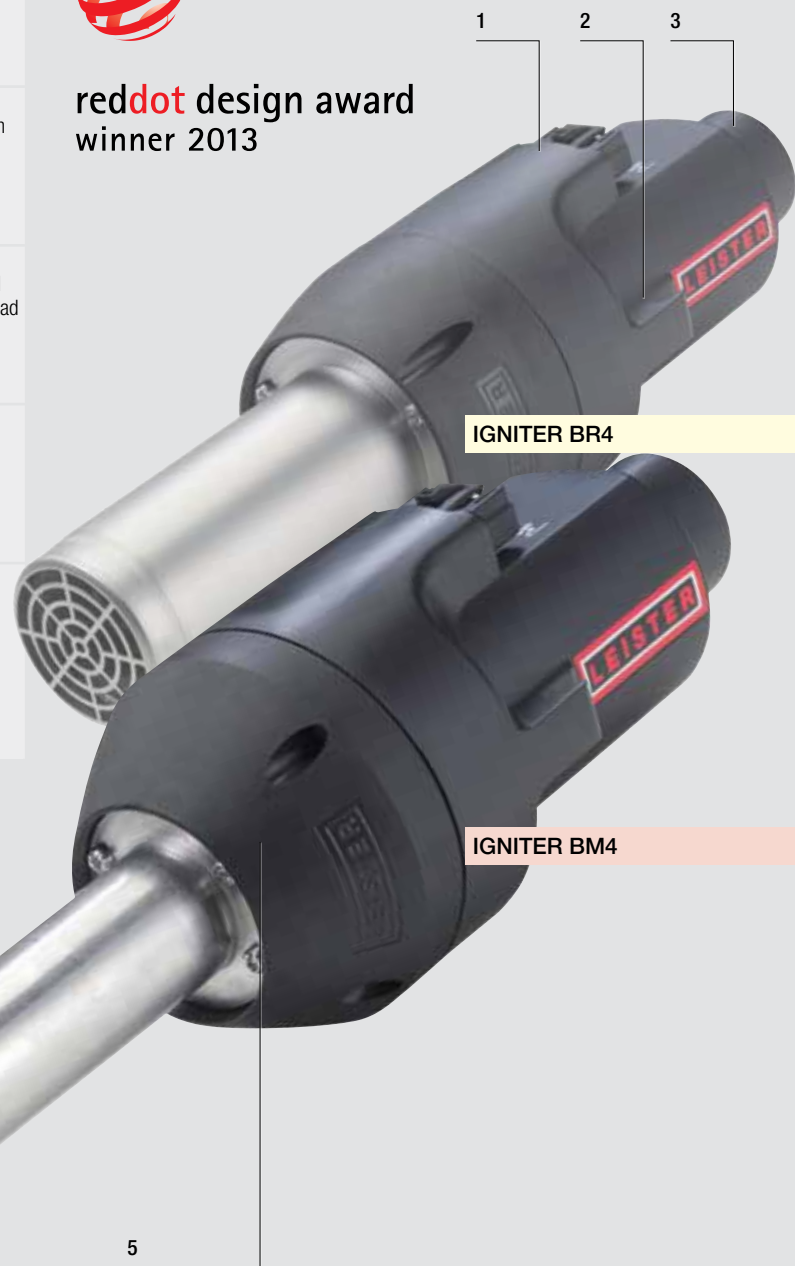



Clean ignition process due to optimum heat level.

Accessories IGNITER

Technical Data	IGNITER BM4							BM4 with M14 screw adapter	BR4
	V	230	230	230	230	230	230		
Voltage	V	120	120	230	230	230	230	230	230
Frequency	Hz	60	60	50	50	50	50	50	50
Power rating	W	1100	1550	600	1100	1600	1100	3400	
Min. air volume	l/min 20°C	230	230	80	230	230	230	360	
Air pressure	kPa	2.48	2.48	0.3	2.48	2.48	2.48	4.00	
Max temperature	°C	600	600	500	600	600	600	650	
Noise emission level	dB (A)	68	68	58	68	68	68	68	
Aperture	mm Ø	90							
Weight	kg	1.0 (without power supply cord)							1.2
Length	mm	283							294
Conformity mark									
Safety standard									
Certification		CCA							
Protection class II									
Article no.		141.882	141.881	139.232	140.711	139.231	144.012	146.296	

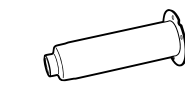

142.414 Accessory screw adapter for M14 extensions

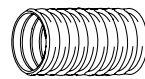

107.286 Air hose Ø 38 mm / Ø 1.5 in



107.287 Hose bracket



142.717 Heating element 230V ~ 1550W
150.871 Heating element 230V ~ 1050W
150.872 Heating element 230V ~ 550W
142.718 Heating element 120V ~ 1500W
150.873 Heating element 120V ~ 1050W
145.606 Heating element (BR4) 230V ~ 3300W

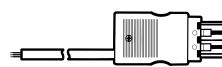

142.967 Power supply cord (rubber) with WAGO plug 3 x 1 mm² x 3 m
143.131 Power supply cord (silicone) with WAGO plug 3 x 1 mm² x 3 m



142.976 Plug with strain relief, kit (WAGO 770) cable Ø 4.5 – 8 mm
148.429 (BR4) Plug with strain relief, kit (WAGO 770) cable Ø 8 – 11.5 mm

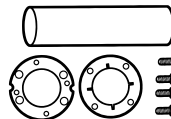

142.359 Accessory adapter to TRIAC S Economy heating pipe

We reserve the right to make technical changes.

Plug for cable connection and cable are not included.

Installation dimensions in mm

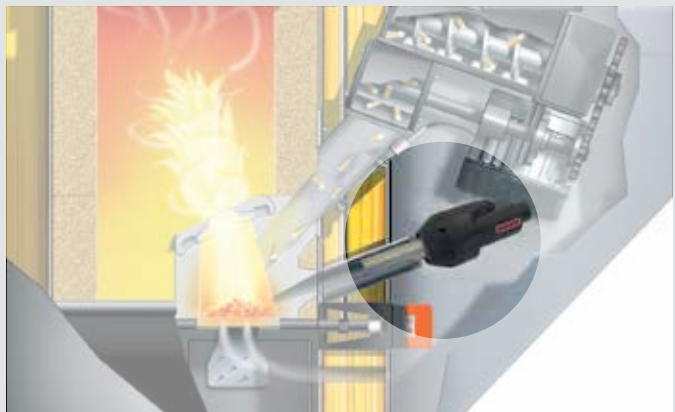
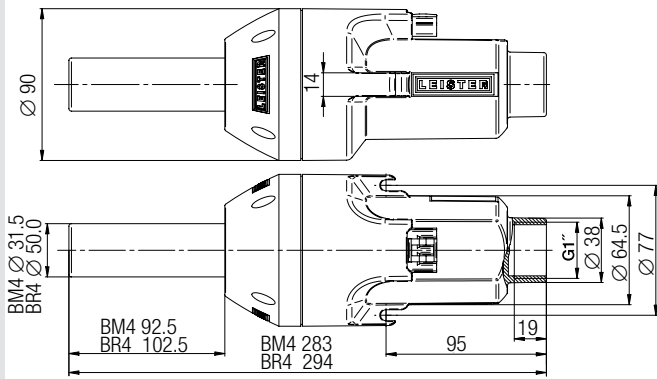

Installation arrangement