

SONO® School Furniture



80 S New!



SONO

CONTENTS

A	Desks, chairs, storage for class 1-6	3
B	Desks and chairs for class 7-9 and upper secondary schools	6
	STRONG -new range of tables and chairs	8
C	Work spaces, for example for teachers	10
D	Furniture for group rooms, dining rooms, libraries etc.	11
	VARYTABLE - height adjustable table	15
E	PC tables, rolling tables, screens, textile handicrafts tables, 'Carpenter' etc.	17
F	Chairs, stackable steel tubing chairs, upholstered chairs, stools and work chairs	20
G	Sofa suites, pupil free time furniture, cloakroom furniture	24
H	Tall cupboards	36
	80 cupboards and bookshelves of width 80 cm	45
	Wardrobes, pupil pigeonholes, teacher pigeonholes etc.	46
	Storage on wheels	50
	Counter unit cupboards, counter unit tops, sink unit fittings	52
	Wall cupboards, drawings cabinet	56
	Cupboard inserts	57
	Accessories and replacement parts for cupboards	59
	Bookshelves, shelf systems, library fittings	61
	Lab. cupboards in high pressure laminate	66
	Storage in melamine	69
	Storage cupboards in sheet steel, fire proof cupboards, poisons cupboards, bottled gas cupboards, fume cupboards	70
K	Whiteboards, rail systems, AV rail systems, notice boards, magazine shelves etc.	71
	Quick delivery range	76
	Replacement parts for tables and chairs	79
	Laminate colours, frame colours, cloth colours	80



Table 65x55 cm, height adjustable 60-78 cm. Lid with high pressure laminate, desk case and horizontal front ledge of solid birch. The lid slopes around 5°, can be set in the horizontal position using a drop leaf in the desk case. 2 bag hooks.

A:1 128 Table 65x55 cm, height adjustable 60-78 cm.

Ztella chair with seat, seatback and adjustable foot rest of solid birch:

- 181 Chair without foot rest, adjustable 35-54
- 182 Chair with foot rest, adjustable 34-54

See also Ziri chair on A:8c and Suzzi chair on A:8



Table 65x55 cm. Lid with high pressure laminate, desk case and horizontal ledge of solid birch. The lid slopes around 5°, can be set in the horizontal position using a drop leaf in the desk case. 2 bag hooks.

- A:2 127 Desk height 80 cm with adjustable footrest
- 129 Desk height 90 cm with adjustable footrest

Chairs with seats and seatbacks of solid birch

- 159 Chairs, adjustable 50-80 cm
- 158 Chair, adult size, adjustable 50-80 cm



Bracket for chair 158

Chair 159 can be hung on the table.



Table 65x55 cm. Lid with high pressure laminate, desk case and horizontal ledge of solid birch. The lid slopes around 5°, can be set in the horizontal position using a drop leaf in the desk case. 2 bag hooks.

- A:3 127 Table height 80 cm with adjustable footrest
- 129 Table height 90 cm with adjustable footrest

Chairs with seats and seatbacks of solid birch

- 183 Ztella chair without footrest, adjustable 50-80 cm
 - 186 Ztella chair 'adult size' without footrest, 50-80 cm
- Bracket for Ztella chair



Table with high pressure laminated table top. Legs of round steel tubing.

- A:5 200 Table 120x60 cm, height 90 cm
- 200 Table 130x65 cm, height 90 cm
- Bracket, long side for 2 chairs
- Bracket, short sides for 2 chairs
- 200 Table 120x70 cm, height 90 cm
- 200 Table 140x70 cm, height 90 cm
- Bracket, long sides for 4 chairs
- Bracket, short sides for 2 chairs
- 209 Semicircular table 120x60 cm, height 90 cm
- 209 Semicircular table 130x65 cm, height 90 cm
- 209 Semicircular table 140x70 cm, height 90 cm
- Bracket for 2 chairs

Ziri chair with seat, seatback and adjustable footrest of solid birch.

- 176 Ziri chair with footrest, adjustable 63-69 cm
- 175 Ziri chair with footrest, adjustable 53-59 cm
- 174 Ziri chair with footrest, adjustable 45-51 cm

A Desks, chairs and storage for class 1-6



The picture shows 90 cm height for the table and 66 cm for the chair.



Tables with high pressure laminated table tops. Legs of round steel tubing.

- | | | |
|-----|--------|--------------------------------------------------|
| A:6 | 200 | Table 120x60 cm, height 72 or 76 cm |
| | 200 | Table 130x65 cm, height 72 or 76 cm |
| | | Bracket, long side for 2 chairs |
| | | Bracket, short sides for 2 chairs |
| | 200 | Table 120x70 cm, height 72 or 76 cm |
| | 200 | Table 140x70 cm, height 72 or 76 cm |
| | | Surcharge, height 80 or 90 cm |
| | | Bracket, long sides for 4 chairs |
| | | Bracket, short sides for 2 chairs |
| | 209 | Semicircular table 120x60 cm, height 72 or 76 cm |
| | 209 | Semicircular table 130x65 cm, height 72 or 76 cm |
| | 209 | Semicircular table 140x70 cm, height 72 or 76 cm |
| | | Surcharge, height 80 or 90 cm |
| | | Bracket for 2 chairs |
| | SCREW | Stepless adjustable, 70-77 cm |
| | ADJUST | Height adjustable 70-85 cm |

Chairs with seats and seatbacks of solid birch.

- | | | |
|------|-----|-----------------------------------------------------|
| | 144 | Suzzi chair 48, 56 or 66 cm, adjustable footrest |
| | 160 | Chair with adjustable footrest, adjustable 50-70 cm |
| A:8d | 181 | Ztella chair without footrest, adjustable 34-54 cm |
| | 182 | Ztella chair with footrest, adjustable 34-54 cm |



- | | | |
|-----|--------|--------------------------------------------------------------------------------------------------------------------------------------------------------------|
| A:7 | 235 | Zam table 120x120, one side rounded radius 60 cm, height 72 cm. Table top with high pressure laminate. Pedestal foot with adjustable black floor protectors. |
| | 150 48 | Chair h=48 cm with seat, seatback and adjustable footrest of solid birch. |
| | 150 56 | Chair h 56 cm, adjustable footrest, side bracing |
| | 150 66 | Chair h 66 cm, adjustable footrest, side bracing |

Chair in solid birch and steel tubing.

- | | | |
|-----|-----|-----------------------------------------------------------------------------------------|
| A:8 | 144 | Chair Suzzi 48, 56, or 66 cm.
Seat, seatback and adjustable footrest of solid birch. |
|-----|-----|-----------------------------------------------------------------------------------------|



Ziri chair with seat, seatback and adjustable footrest of solid birch.

A:8c	171	Adjustable 45-51 cm, without footrest
	172	Adjustable 53-59 cm, without footrest
	173	Adjustable 63-69 cm, without footrest
	174	Adjustable 45-51 cm, with footrest
	175	Adjustable 53-59 cm, with footrest
	176	Adjustable 63-69 cm, with footrest

Ztella chair with seat, seatback and adjustable footrest of solid birch.

A:8d	181	Chair without footrest, adjustable 34-54 cm
	182	Chair with footrest, adjustable 34-54 cm
	183	Chair without footrest, adjustable 50-80 cm
	184	Chair with footrest, adjustable 50-70 cm
	185	Chair 'adult size' without footrest, 34-54 cm
	186	Chair 'adult size' without footrest, 50-80 cm

Storage in beech or birch veneer. Drawers in plywood on expansion fitting. 5 wheels of which 2 lockable. 1,000 x 450 mm.

A:10	494 000	Storage 10 drawers, h 900 mm
	494 000/5	Storage 5 drawers, one shelf, h 900mm
	494 000/6	Storage 6 drawers, one shelf, h 900mm
	A404F	Notice board back
	S 294 100	Storage 10 drawers, file bay, h 1,280 mm
	A204F	Notice board back
	494 000/50	Storage 5 drawers, w 500 mm, h 900 mm
	404 200	Storage, two shelves, h 880 mm

Storage

Storage with shell, back and front panels in birch pattern or grey melamine. Drawers in plywood on expansion fitting. Shell and drawer front panel edged with ABS edging. 5 wheels of which 2 with brake. 1,000x450 mm, height 900 mm.

M97.010.1	Storage with 10 drawers, birch melamine
M97.010.2	Storage with 10 drawers, grey melamine
M97.105.1	Storage with 5 drawers, birch melamine
M97.105.2	Storage with 5 drawers, grey melamine

New!

A Desks, chairs and storage for class 1-6



Storage 'Wheat' with birch veneered shell and white painted drawer frontpanel, 5 wheels of which 2 lockable. 1,200 x 450 mm.

- A:10b 124 005X Pupil storage 10 drawers, h 720 mm
 124 006 Pupil storage 12 drawers, h 900 mm
 124 915 Pupil storage, 6 drawers, shelves, h 900 mm
 White drawer front panel is standard.

- A 124 Notice board back
 W124 Back with whiteboard

NB! Drawers supplied with expansion fitting and stops.



Storage in beech or birch veneer. Drawers in plywood which slide on wood strips. Five wheels of which two lockable.

- A:11 404 908 Storage 16 wood drawers, h880 mm
 404 914 Storage 8 wood drawers, 1 shelf, h880 mm
 A404F Notice board back
 204 908 Storage 16 wood drawers, file bay, h 1280 mm
 204 114 Storage 8 wood drawers, 2 shelves, file bay, h 1280 mm
 A204F Notice board back



Shelf/storage in beech or birch veneer. Five wheels of which two lockable.

- A:12 204 200 Shelves on wheels, 2 shelves, h 1280
 439 Pupil drawers, dark grey
 A204 F Notice board back



Tray and crate rack with frame in steel tubing and stable wheels, incl top panel. Trays in laminated birch 30x40 cm. Storage crates in white impact resistant plastic 30x40x11 cm (red and blue trays also available)

- A13 602103 70x40 h=101 cm, 2x7 trays
 602303 70x40 h=138 cm, 2x10 trays
 602503 102x40 h=101 cm, 3x7 trays
 603103 70x40 h=101 cm, 2x7 crates
 603303 70x40 h=138 cm, 2x10 crates
 603503 102x40 h=101 cm, 3x7 crates
 604103 70x40 h=101 cm, 7 trays+7 crates
 640000 Tray 30x40 cm in laminated birch
 603903 Plastic crate 30x40x11 cm, white

B Desks and chairs for class 7-9 and secondary schools



Zack table with high pressure laminated table top, steel profile with hooks on both sides. Adjustment screws on two legs. Bracket for 4 leg chairs included.

- B:1 187 Zack table 70x60 cm height 72 or 76 cm
 Surcharge for height 80 or 90 cm

Chairs with seats and seatbacks of birch.

- 141 Suzan chair height 44 or 48 cm
 146 Suzette chair with footrest, height 52 or 62 cm



Zpik table with high pressure laminated table top. Round legs with pivoted, adjustable floor protector.

B:1b	162	Zpik table 70x60 cm, height 72 or 76 cm
	162	Zpik table 80x60 cm, height 72 or 76 cm
		Bracket for chair

Chairs with seats and seatbacks of birch.

	147	Zanna chair, height 44 or 48 cm
F:6	141	Suzan chair height 44 or 48 cm
F:8	151	Chair height 44 or 48 cm



Znok table with curved table top, high pressure laminated MDF. Round legs with pivoted, adjustable floor protector.

B:1c	163	Table Znok 70x60 cm, height 72 or 76 cm
		Bracket for chair

Chairs with seats and seatbacks of birch.

	147	Zanna chair, height 44 or 48 cm
F:6	141	Suzan chair, height 44 or 48 cm
F:8	151	Chair height 44 or 48 cm



Table with high pressure laminated table top. Legs of round steel tubing. Bag hooks on table 166.

B:2	166	Table 70x60 cm, height 72 or 76 cm
	166	Table 80x60 cm, height 72 or 76 cm
	266	Table 70x60 cm, height 80 or 90 cm
	ADJUST	Adjustable 70-85 cm, surcharge
		Bracket for chair
	866	Bag hook for table 266 - each

Chairs with seats and seatbacks of birch.

	151	Chair height 44 or 48 cm
F:6	141	Suzan chair, height 44 or 48 cm
F:7	145	Chair height 44 cm
B:6	156	Chair with footrest, height 52 or 62 cm
	146	Suzette chair with footrest, height 52 or 62 cm
F:9	351	Chair height 44 or 48 cm, seat and seatback in plastic



Table with high pressure laminated table top which can be angled in 12 positions, 5-27°. Legs of round steel tubing. Two bag hooks.

B:4	169	Table 70x60 cm, height 72 or 76 cm
	169	Table 80x60 cm, height 72 or 76 cm
	ADJUST	Adjustable 70-85 cm, surcharge
		Bracket for chair
	148	Liza chair height 44 or 48 cm, tiltable in two positions. Seat and seatback of birch.
	185	Ztella chair with seat and seatback of birch, adjustable height 34-54 cm.



Chairs with seats and seatbacks of birch.

B:6	146	Chair Suzette with footrest, height 52 or 62 cm
	156	Chair with footrest, height 52 or 62 cm
	312F	Work chair, automatic height setting, footrest hoop and school security, with wheels (HJ) or slide feet (GL) Seat and seatback of beech or birch. Height 50-69 cm

Work chairs, see F:11 and F:13

e = economy

Table top in grey melamine with birch pattern plastic edging. 4 leg frame in silver.

c = comfort

Table top in high pressure laminate (4 standard colours) with plastic edging. L-frame in silver. Colours - see page 80

v = vision

Shaped table top in high pressure laminate with plastic edging or 4 mm wood edging. Colours - see page 80 L-frame. Colours - see page 80

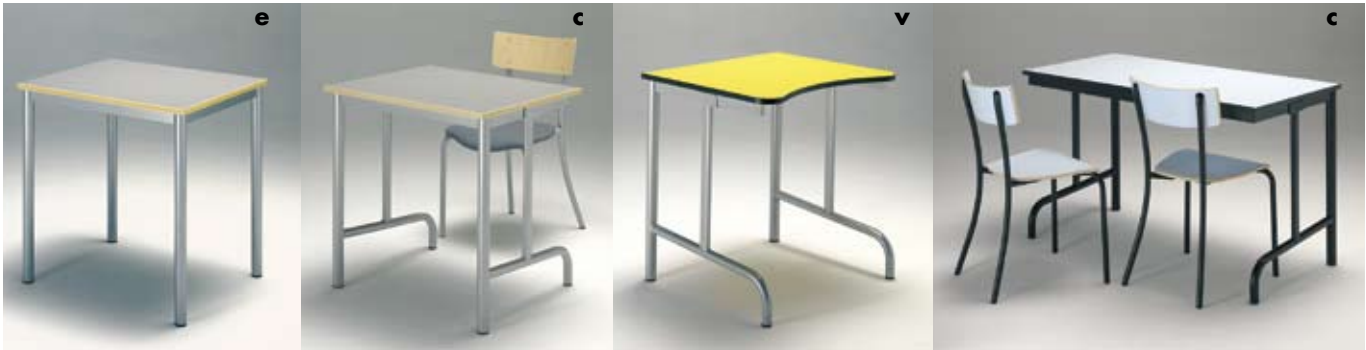

e (economy) **c** (comfort) **v** (vision)

- 300 Single pupil table with table top 70x60 cm. Height 72, 76 or 90 cm. 4 leg frame.
- 301 Single pupil table with table top 70x60 cm. Height 72, 76 or 90 cm. Lframe.
- Accessories for single pupil table:
- Bracket fitting for chair
- 866 Bag hook
- Storage drawer
- 300 Double pupil table with table top 120x60 cm. Height 72, 76 or 90 cm. 4 leg frame.
- 301 Double pupil table with table top 120x60 cm. Height 72, 76 or 90 cm. Lframe.
- Accessories for double pupil table:
- Bracket fitting for 2 chairs
- 866 Bag hook



e (economy) **c** (comfort) **v** (vision)

- 300 Teacher table with table top 140x70 cm. Height 72, 76 or 90 cm. 4 leg frame.
- 301 Teacher table with table top 140x70 cm. Height 72, 76 or 90 cm. Lframe.
- Accessories for teacher table:
- 313 3-drawer drawer unit
- 809..144 Front panel of perforated sheet steel (.. replace with 80 for black and 73 for silver)
- 810..144 Front panel overlaid with laminate (.. replace with laminate colour)

e = economy

Seat and seatback of MDF overlaid with birch pattern melamine. Steel tubing frame in silver. Stackable.

c = comfort

Moulded seat and seatback overlaid with high pressure laminate (4 standard colours).
Option: seat upholstered in class 1 fabric.
Frame in silver.

v = vision

Moulded seat and seatback overlaid with high pressure laminate.
Colours - see page 80
Option: seat upholstered in class 1 fabric.
Frame in colours as shown on page 80



e (economy)

c (comfort)

v (vision)

- 110 Height 44 or 48 cm
- 110 Height 62 cm with footrest
- 111 Height 44 or 48 cm
- 111 Height 62 cm with footrest
- 111 Ks Height 44 or 48 cm, seat upholstered with class 1 fabric
- 111 Ks Height 62 cm with footrest, seat upholstered with class 1 fabric
- 112 Height 44 or 48 cm
- 112 Height 62 cm with footrest
- 112 Ks Height 44 or 48 cm, seat upholstered with class 1 fabric
- 112 Ks Height 62 cm with footrest, seat upholstered with class 1 fabric

e = economy

Work chair, height adjustable, adjustable back. Upholstered seat, seatback of polypropylene and glassfibre. Black 5 foot pedestal with wheels.

c = comfort

Work chair, height adjustable and adjustable seat and seatback, synchronising mechanism. Upholstered seat, seatback of polypropylene and glassfibre. Black 5 foot pedestal with wheels. Arm available as option.

v = vision

Work chair, height adjustable and adjustable seat and seatback, synchronizing mechanism. Upholstered seat and seatback. Chromate 5-foot pedestal with wheels. Arm available as option.



e (economy)

c (comfort)

v (vision)

UWU 20E	seat upholstered in fabric class A
UWU 20SP	seat upholstered in fabric class B
UWU A	adjustable arm
UWU 21SW	seat and seatback upholstered in fabric class A
UWU A	seat and seatback upholstered in fabric class B
UWU A	adjustable arm
Standard fabrics:	fabric class A = black, grey, blue and red fabric class B = green, orange



Work table

-with many combination options



200 **Work table with high pressure laminated table top.
4 leg frame of steel tubing.**

table top 120x60 cm, height 72 or 76 cm
table top 120x70 cm, height 72 or 76 cm
table top 140x70 cm, height 72 or 76 cm
height 80 or 90 cm – surcharge
Stepless adjustable 70-77 cm

SCREW

Front panel overlaid with laminate

(. replace with 24 for birch laminate and 49 for oak laminate)

810..124 h=44 cm for table l=120 cm and h=72/76 cm

810..126 h=62 cm for table l=120 cm and h=80/90 cm

810..144 h=44 cm for table l=140 cm and h=72/76 cm

810..146 h=62 cm for table l=140 cm and h=80/90 cm

Front panel of perforated sheet steel, painted in the same colour as the frame

(. replace with 71 for grey metallic, 80 for black etc.)

809..124 h=44 cm for table l=120 cm and h=72/76 cm

809..126 h=62 cm for table l=120 cm and h=80/90 cm

809..144 h=44 cm for table l=140 cm and h=72/76 cm

809..146 h=62 cm for table l=140 cm and h=80/90 cm

Drawer unit b=41 x d=54 cm in birch or oak.

Top drawer lockable.

211 1-drawer drawer unit for mounting, h=12 cm

213 3-drawer drawer unit for mounting, h=40 cm

214 4-drawer drawer unit with top and base, h=65 cm

215 Rolling drawer unit with 4 drawers, top and 4 wheels of which 2 lockable, h=65 cm

216 4-drawer drawer unit for mounting, h=58 cm

C-LOCK Central lock for 3- and 4-drawer drawer unit

For painted drawer fronts, surcharge of 10 % on the drawer unit price.

Free standing desk 50x50 cm, h=110 cm, table top 50x65 cm rounded rear edge. 2 drawers on an expansion fitting, 4 lockable wheels.

C:9 640 Free standing desk in birch or oak.

Lockable door

Folding leaf each

640



Zeb table. Table top with high pressure laminate. Pedestal frame with adjustable black floor protectors. Other table top finishes can be supplied.

D:1	231	Zeb table 120x70, height 72 or 76 cm
	231	Zeb table 140x70, height 72 or 76 cm
	231	Zeb table 120x80, height 72 or 76 cm
	231	Zeb table 140x80, height 72 or 76 cm
		Bracket for 4 chairs
	231	Zeb table 165x70, height 72 or 76 cm
	231	Zeb table 180x70, height 72 or 76 cm
	231	Zeb table 180x80, height 72 or 76 cm
		Bracket for 6 chairs

Chairs with seats and seatbacks of birch.

	141	Suzan chair height 44 or 48 cm
		Staining in standard colours
D:5	145	Chair height 44 cm



Round Zam table. Table top with high pressure laminate. Pedestal frame with adjustable black floor protectors. Other table top finishes can be supplied.

D:2	235	table top ø70 cm, h 72 cm or 76 cm
		table top ø90 cm, h 72 cm or 76 cm
		table top ø120 cm, h 72 cm or 76 cm
		table top ø150 cm, h 72 cm or 76 cm
		table top 120x120 cm, h 72 cm or 76 cm
		table top 120x120 cm, one side rounded radius 60 cm
		Bracket for 6 chairs of ø120 cm

Chairs with seats and seatbacks of birch.

	141	Suzan chair height 44 or 48 cm
		Staining in standard colours



Table with high pressure laminated table top. 4 leg frame of steel tubing. Other table top finishes can be supplied.

D:3	200	Table 120x60 cm h 68, 72 or 76 cm
	200	Table 140x60 cm, h 68, 72 or 76 cm
	200	Table 130x65 cm, h 68, 72 or 76 cm
		Bracket, one long side for two chairs
	200	Table 120x70 cm, h 68, 72 or 76 cm
	200	Table 140x70 cm, h 68, 72 or 76 cm
	200	Table 180x70 cm, h 68, 72 or 76 cm
	200	Table 120x80 cm, h 68, 72 or 76 cm
	200	Table 140x80 cm, h 68, 72 or 76 cm
	200	Table 180x80 cm, h 68, 72 or 76 cm
	200	Table 120x90 cm, h 68, 72 or 76 cm
	200	Table 120x120 cm, h 68, 72 or 76 cm
		Bracket for 4 chairs
		Bracket for 6 chairs
		Height 80 or 90 cm surcharge
	SCREW	Stepless adjustable 70-77 cm
	ADJUST	Height adjustable 70-85 cm
		Floor fitting - set of 4

Chairs with seats and seatbacks of birch.

	151	Chair height 44 or 48 cm
D:1	141	Suzan chair, height 44 or 48 cm



Zpik table with high pressure laminated table top. Round legs with pivoted, adjustable floor protector. Other table top finishes can be supplied. Table width 70 cm and lengths from 140 cm can be supplied with bracket for chairs.

- D:3b 222 Zpik table 120x60 cm, height 72 or 76 cm
 222 Zpik table 140x60 cm, height 72 or 76 cm
 222 Zpik table 120x70 cm, height 72 or 76 cm
 222 Zpik table 140x70 cm, height 72 or 76 cm
 222 Zpik table 180x70 cm, height 72 or 76 cm
 222 Zpik table 120x80 cm, height 72 or 76 cm
 222 Zpik table 140x80 cm, height 72 or 76 cm
 222 Zpik table 180x80 cm, height 72 or 76 cm
 Bracket for 4 chairs
 Bracket for 6 chairs

Chairs with seats and seatbacks of birch.

- 147 Zanna chair, height 44 or 48 cm
 D:1 141 Suzan chair, height 44 or 48 cm



Znok table with curved table top, high pressure laminate MDF. Round legs with pivoted, adjustable floor protectors. Other finishes can be supplied. Table width 70 cm and lengths from 140 cm can be supplied with bracket for chairs.

- D:3c 223 Znok table 120x60 cm, height 72 or 76 cm
 223 Znok table 140x60 cm, height 72 or 76 cm
 223 Znok table 120x70 cm, height 72 or 76 cm
 223 Znok table 140x70 cm, height 72 or 76 cm
 223 Znok table 180x70 cm, height 72 or 76 cm
 Bracket for 4 chairs
 Bracket for 6 chairs

Chairs with seats and seatbacks of birch.

- 147 Zanna chair, height 44 or 48 cm
 D:1 141 Suzan chair, height 44 or 48 cm



Table with high pressure laminated table top. 4 leg frame of steel tubing. Other table top finishes can be supplied.

- D:5 206 Table Ø 120 cm, h 68, 72 or 76 cm
 206 Table Ø 150 cm h 68, 72 or 76 cm
 Height 80 or 90 cm, surcharge
 SCREW Stepless adjustable 70-77 cm
 ADJUST Height adjustable 70-85 cm

Chairs with seats and seatbacks of birch.

- 145 Chair height 44 cm
 D:4 151 Chair height 44 or 48 cm

**Zam group table**

Table top with high pressure laminate. Pedestal frame with adjustable black floor protectors. Other table top finishes can be supplied.

D:6	235	table top 120x120 cm, h 72 or 76 cm table top 120x120 cm, one side rounded radius 60 cm table top \varnothing 120 cm, h 72 or 76 cm table top \varnothing 150 cm, h 72 or 76 cm
	61	Ronja chair in natural birch, seat upholstered in fabric class 1 seat upholstered in fabric class 2 seat upholstered in fabric class 3 seat upholstered in fabric class 4



Semicircular table with high pressure laminated table top. Legs of round steel tubing. Other table top finishes can be supplied.

D:7	209	Semicircular table 120x60 cm, h 72 or 76 cm
	209	Semicircular table 130x65 cm, h 72 or 76 cm
	209	Semicircular table 140x70 cm, h 72 or 76 cm Surcharge, height 80 or 90 cm Bracket for 2 chairs
	200	Table - see sheet D:3
	148	Liza chair, height 44 or 48 cm, tiltable in two positions. Seat and seatback of birch.
	195	Trapezoidal table with high pressure laminated table top 120/60x52. Legs of round steel tubing. H 72 or 76 cm



Birk table with legs and frame of solid birch. Table top with high pressure laminate or birch veneer. Other table top finishes can be supplied.

D:8	102	Birk table 120x60 cm, height 72 cm
	102	Birk table 140x60 cm, height 72 cm
	102	Birk table 120x70 cm, height 72 cm
	102	Birk table 140x70 cm, height 72 cm
	102	Birk table 180x70 cm, height 72 cm
	102	Birk table 120x80 cm, height 72 cm
	102	Birk table 140x80 cm, height 72 cm
	102	Birk table 180x80 cm, height 72 cm
	102	Birk table 120x120 cm, height 72 cm Bracket for 4 chairs 60 Bracket for 6 chairs 60
	60	Ronja chair, natural birch, not upholstered



Round Bork table with legs and frame of solid birch. Table top with high pressure laminate or birch veneer. Other table top finishes can be supplied.

D:9	103	Round Bork table \varnothing 120 cm, height 72 cm
	61	Ronja chair, seat upholstered in fabric class 1
	61	Ronja chair, seat upholstered in fabric class 2
	61	Ronja chair, seat upholstered in fabric class 3
	61	Ronja chair, seat upholstered in fabric class 4
	62	Ronja chair, seat and seatback upholstered in fabric class 1
	62	Ronja chair, seat and seatback upholstered in fabric class 2
	62	Ronja chair, seat and seatback upholstered in fabric class 3
	62	Ronja chair, seat and seatback upholstered in fabric class 4



105 Semicircular Bork table

Semicircular Bork table with legs and frame of solid birch. Table top with high pressure laminate or birch veneer. Other table top finishes can be supplied.

D:10	105	Semicircular Bork table 120x60, height 72 cm
	102	Birk table 120x60, height 72 cm
	102	Birk table 120x70, height 72 cm
	102	Birk table 120x80, height 72 cm
	60	Ronja chair, natural birch, not upholstered



74 Jennifer

75 Jennifer

Nova table with legs of laminated beech or birch. Table top with high pressure laminate or birch veneer.

D:11	1602	Table 60x80 cm
	1607	Table 120x70 cm
	1608	Table 120x80 cm
	1609	Table 140x80 cm
	1611	Table 180x80 cm
	1621	Semicircular table, 120x60 cm, 3 legs
	1625	Table Ø 70 cm
	1628	Table Ø 120 cm
	9203	Protective studs - per table
	9204	Extra leg for semicircular table
	9200	Connecting fitting - per pair
	74	Jennifer chair, natural beech, not upholstered
	75	Jennifer chair, seat upholstered in fabric class 1
	75	Jennifer chair, seat upholstered in fabric class 2
	75	Jennifer chair, seat upholstered in fabric class 3
	75	Jennifer chair, seat upholstered in fabric class 4
		Available also in birch, see sheet F:3



425

427

Folding table with 'quick coupling fitting'. Wood frame of ramin. Oil tempered fibreboard or table top overlaid with beech foil. Height 74 cm.

425	120x60 cm, weight 11 kg
	180x60 cm, weight 13 kg
	120x70 cm, weight 12 kg
	150x70 cm, weight 13 kg
	180x70 cm, weight 15 kg
	120x80 cm, weight 13 kg
	150x80 cm, weight 14 kg
	180x80 cm, weight 15 kg



4680

Folding table with strong folding mechanism. Steel tube frame. Table top with high pressure laminate. Other table top finishes can be supplied. Height 72 cm.

427	120x60 cm, weight 19 kg
	120x70 cm, weight 21 kg
	140x70 cm, weight 23 kg
	180x70 cm, weight 27 kg
	120x80 cm, weight 24 kg
	180x80 cm, weight 30 kg

Conference table with black retractable pedestal frame. Table top with birch or beech pattern melamine or high pressure laminate.

4680-90	120x45 cm, weight 14 kg
4680-54	120x60 cm, weight 16 kg
RS09851	Table trolley 125x71 cm
RS09852	Table trolley 200x71 cm
RS09860	Draw bar with rubber wheels. Required for table trolley.
RS09861	Hackle with cross bar, protected by sliding fitting



Café table. Table top with high pressure laminate.
Pedestal frame with disk foot.
Height 58, 72, 90 or 105 cm.
Other table top finishes can be supplied.

New!

- 245 table top ø 70 cm with one column
- table top ø 90 cm with one column
- table top 70 x 70 cm with one column
- table top 120 x 70 cm with two columns
- table top 140 x 70 cm with two columns
- table top 180 x 70 cm with two columns

VARYTABLE - height adjustable work table



ALLEGRO is an electric height adjustable two pedestal frame with three section columns.
The frame can be adapted to different table top combinations from 120 to 240 cm width and 60 or 80 cm depth.

Two column Allegro. Height 69-119 cm. Two pedestal frame silver RAL 9006. Lifting capacity 120 kg.
For connection to the mains network 220-240 V.

New!

- table top in plywood with high pressure laminate:*
- 502 180x80 cm with body recess
 - 502 180x100/80 cm
 - 502 120x80 cm

- table top in high pressure laminate with wood edging:*
- 502 180x80 cm without body recess
 - 502 120x80 cm

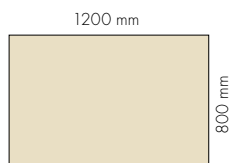
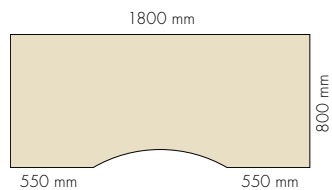
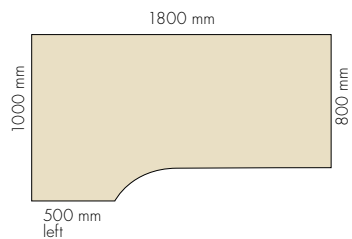

More **VARYTABLE** on the next page >>>

VARYTABLE - height adjustable work table



507

CHICO is an electric height adjustable single pedestal frame on wheels for small work spaces.

Single column Chico table. Height 71-121 cm. Single pedestal frame silver RAL 9006. For connection to the mains network 220 - 240 V or battery operation.

New!

Mains connection:

table top in plywood with high pressure laminate

507 N ø 80 cm

507 N heart shaped 70x70 cm

table top in high pressure laminate with wood edging:

507 N ø 70 cm

507 N ø 90 cm

Battery operation:

table top in plywood with high pressure laminate

507 B ø 80 cm

507 B table top heart shaped 70x70 cm

table top in high pressure laminate with wood edging

507 B ø 70 cm

507 B ø 90 cm

507-1 CPU holder, complete with straps

and multiway socket with three earthed sockets

507-2 Flat screen holder, vertical, height

adjustable, tiltable



509

UNO is the perfect table for all uses. It can be both a work and free time table, both sitting and standing. Height adjustment via press buttons.

Single column Uno table. Height 68-118 cm. Single pedestal frame silver RAL 9006. For connection to the mains network 220 - 240 V or battery operation.

New!

Mains networkconnection:

table top in plywood with high pressure laminate

509 N ø 80 cm

509 N heart shaped 70x70 cm

table top in high pressure laminate with wood edging

509 N ø 70 cm

509 N ø 90 cm

Battery operation:

table top in plywood with high pressure laminate

509 B ø 80 cm

509 B heart shaped 70x70 cm

table top in high pressure laminate with wood edging

509 B ø 70 cm

509 B ø 90 cm

Storage



M97.010



M97.105

Storage with shell, back and front panels in birch pattern or grey melamine. Drawers in plywood on expansion fitting. Shell and drawer front panel edged with ABS edging.

5 wheels of which 2 with brake. 1,000x450 mm, height 900 mm.

M97.010.1 Storage with 10 drawers, birch melamine

M97.010.2 Storage with 10 drawers, grey melamine

M97.105.1 Storage with 5 drawers, birch melamine

M97.105.2 Storage with 5 drawers, grey melamine

VARYTABLE -height adjustable work table



Single column **SOLIDO table**. Table top of plywood overlaid with high pressure laminate. Height 69 - 119 cm. **New!**
 Single pedestal frame, black RAL 9005 or silver RAL 9006.
 Lifting capacity 100 kg. For connection to the mains network 220-240 V.

- 506 table top 125x125 cm, one round corner radius 80 cm, body recess radius 45 cm
- 506 180x80 cm with body recess
- 506 180x100/80 cm
- 506-8 footrest, black
- 506-7 footrest, silver

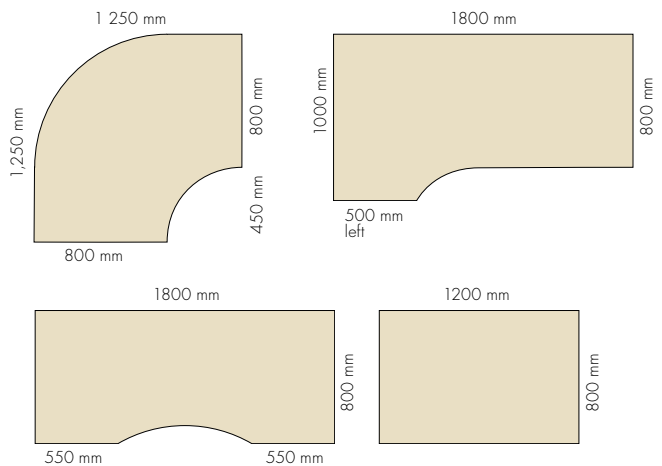

E PC tables, rolling tables, AV-tables, trellises, screens and textile handicrafts tables



PC table with high pressure laminated table top. Computer drawer unit open front and back, lockable with strong flat bar with hole for padlock. Keyboard tray with lock function. **New!**

- E:1 239 PC table 90x60 cm, height 76 cm
- 239 PC table 120x60 cm height 76 cm
- 240 PC table 90x60 cm height 76 cm, wheels
- 240 PC table 120x60 cm height 76 cm, wheels



PC table Doz, corner table, with high pressure laminated table top. Computer drawer unit open front and back, lockable with strong flat bar with hole for padlock. Keyboard tray with lock function.

- E:1b 229 PC table Doz height 76 cm

Work chair with tilt, automatic back adjustment, gas raising unit. School security.

- 310-1 Work chair upholstered with Oxford fabric, wheels
- 310-2 Work chair upholstered in fabric class 2, wheels
- 310-3 Work chair upholstered in fabric class 3, wheels
- 310-4 Work chair upholstered in fabric class 4, wheels
Slide feet for the same price.
- 4701 Adjustable arm

310-1

229



PC table Doz, corner table, with high pressure laminated table top. Computer drawer unit open front and back, lockable with strong flat bar with hole for padlock. Keyboard tray with lock function.

E:1c	229	PC table Doz height 90 cm
	230	PC table Doz standing height 105 cm

Work chair with tilt, automatic back adjustment, gas raising unit. School security.

310-1	Work chair upholstered with Oxford fabric, wheels
310-2	Work chair upholstered in fabric class 2, wheels
310-3	Work chair upholstered in fabric class 3, wheels
	Slide feet for the same price
5850	Footrest hoop black
7010	Raised spindle
4701	Adjustable arm



Rolling table with 4 wheels of which 2 lockable. High pressure laminated table top with 15 mm raised edge.

E:3	208	Rolling table 80x60, height 72 cm
	208	Rolling table 80x60, height 90 cm
	308	TV-video table 80x60, height 132 cm

Tray and crate rack with frame in steel tubing and stable wheels, incl top panel. Trays in laminated birch 30x40 cm. Storage crates in white impact resistant plastic 30x40x11 cm (red and blue crates also available)

602103	70x40 h=101 cm, 2x7 trays
602303	70x40 h=138 cm, 2x10 trays
602503	102x40 h=101 cm, 3x7 trays
603103	70x40 h=101 cm, 2x7 crates
603303	70x40 h=138 cm, 2x10 crates
603503	102x40 h=101 cm, 3x7 crates
604103	70x40 h=101 cm, 7 trays+7 crates
640000	Tray 30x40 cm in laminated birch
603903	Plastic crate 30x40x11 cm, white

Rolling table/food trolley 75x50 cm, h=83 cm. Steel tubing frame with 4 strong wheels of which 2 lockable. Leafs in laminate.

614103	Food trolley
601303	Cutlery box incl plastic insert (positioned under upper shelf)



Natura screen 750 x 1,500 mm with frame of beech or natural birch.

New!

E:4	5789000	Natura Cirkel, filler: cross veneered natural birch
	5789003	acrylic plastic: blue, red, orange, opal white, frost
	5789010	Natura Kvadrat, filler: cross veneered natural birch
	5789013	acrylic plastic: blue, red, orange, opal white, frost
	5789020	Natura Kryss, filler: cross veneered natural birch
	5789023	acrylic plastic: blue, red, orange, opal white, frost
	5789002	Natura Slät, filler: cross veneered natural birch
	5789022	acrylic plastic: blue, red, orange, opal white, frost

5789040+	Aluminium foot Ø285x90 mm supplemented with
+5789056	single bottom fitting or
+5789053	double bottom fitting
5789054	Leg 90, single
5789051	Leg fitting 90 double
5789044	Wood foot, single, 400 mm
5789045	natural beech stained
5789048	natural birch

5789046	Wood foot, double 400 mm	beech natural
5789047		stained
5789049		natural birch
5789055	Leg 40, single	
5789052	Leg fitting 40, double	
5789050	Top fitting	
5789057	Wall bracket, pivoted	



Screens with screen height 120 cm and total height 160 cm.

- E:5
- 5010HJ 3-part b=3x80 cm, white/hessian, wheels
 - 5010PF 3-part b=3x80 cm, white/hessian, plastic feet
 - 5020HJ Single b=100 cm, white/hessian, wheels
 - 5020PF Single b=100 cm, white/hessian, plastic feet
 - 5011HJ 3-part b=3x80 cm, silver/blue fabric, wheels
 - 5011PF 3-part b=3x80 cm, silver/blue fabric, plastic feet
 - 5021HJ Single b=100 cm, silver/blue fabric, wheels
 - 5021PF Single b=100 cm, silver/blue fabric, plastic feet



Sewing table with high pressure laminated table top. Drawer unit with one plastic tray and one open bay for sewing machine with extendable shelf on expansion fitting.

- E:6
- 134 Sewing table 120x120 h 90 cm with footrest
 - 133 Sewing table 120x60 h 90 cm with footrest
 - Lockable door - each
 - Electric equipment - per space

Work chair with seat and seatback of beech or birch. Gas raising unit. School security.

- 312GL Chair aut height adjustment 38-52 cm, sliders
- 312HJ Chair aut height adjustment 38-52 cm, wheels
- 7010 Raised spindle 50-69 cm



Sewing table with high pressure laminated table top. Drawer unit with one plastic tray and one open bay for sewing machine with extendable shelf on expansion fitting.

- E:7
- 135 Sewing table 120x60 height 72 cm
 - 136 Sewing table 120x120 height 72 cm
 - Lockable door - each
 - Electrical equipment - per space

Work chair with seat and seatback of beech or birch. Gas raising unit. School security.

- 312GL Chair aut height adjustment 38-52 cm, sliders
- 312HJ Chair aut height adjustment 38-52 cm, wheels



Press table, table top and two extractable ironing boards upholstered with polyester and silicon fabric. Shelf overlaid with high pressure laminate.

- E:8
- 137 Press table 120x90 height 85 cm, beech
 - 237 Press table 120x90 height 85 cm, birch

Blanking table with high pressure laminated table top. From one side 4 drawers and from other 5 drawers. Top drawer is throughgoing. Under the drawers is a holder for paper rolls.

- 138 Cutting table 120x90 height 90 cm, beech
- 238 Cutting table 120x90 height 90 cm, birch
- 200 Table without drawers 120x90 height 90 cm



E PC tables, rolling tables, AV-tables, trellises, screens and textile handicrafts tables

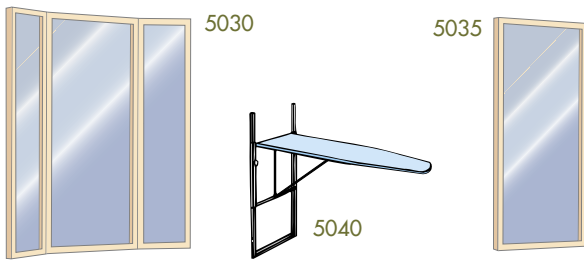

Mirrors with frame of beech or birch.
Mirror glass with safety film.

E:9	5030	3-part mirror, 30+60+30 x 122 cm
	5035	Mirror 62x122 cm
	5040	Wall mounted ironing board 128 x 38 cm, height adjustable. Foldable against wall



Carpenter - mobile studio table

The table has as standard a varnished solid oak table top, as an option is available a high pressure laminated table top. Under this are 6 wood drawers and 6 open bays on each long side, for storage of work, tools and materials. Shell and drawers are of clear varnished birch veneer. Height 900 mm. Table top overhang makes it possible to sit on high chairs around the table. A flexible work space suitable for many environments.

360-56	table top 2,000 x 1,200 mm of solid oak
360-55	table top 2000 x 1200 mm with oak laminate K 6149

F Chairs, stackable steel tubing chairs, upholstered chairs, stools and work chairs



Ronja chair of solid birch. Stackable.
including plastic floor protectors.

F:1	60	Ronja chair, natural birch, not upholstered
	61	Ronja chair, seat upholstered in fabric class 1
	61	Ronja chair, seat upholstered in fabric class 2
	61	Ronja chair, seat upholstered in fabric class 3
	61	Ronja chair, seat upholstered in fabric class 4
	62	Ronja chair, seat and seatback upholstered in fabric class 1
	62	Ronja chair, seat and seatback upholstered in fabric class 2
	62	Ronja chair, seat and seatback upholstered in fabric class 3
	62	Ronja chair, seat and seatback upholstered in fabric class 4
		Felt floor protectors - surcharge



Jennifer chair of laminated beech or birch.
Mounting bar on the arm. Stackable.

F:3	74	Jennifer chair, natural beech, not upholstered
	75-1	Jennifer chair, seat upholstered in fabric class 1, beech
	75-2	Jennifer chair, seat upholstered in fabric class 2, beech
	75-3	Jennifer chair, seat upholstered in fabric class 3, beech
	75-4	Jennifer chair, seat upholstered in fabric class 4, beech
	78	Jennifer chair, natural birch, not upholstered
	79-1	Jennifer chair, seat upholstered in fabric class 1, birch
	79-2	Jennifer chair, seat upholstered in fabric class 2, birch
	79-3	Jennifer chair, seat upholstered in fabric class 3, birch
	79-4	Jennifer chair, seat upholstered in fabric class 4, birch
		Height adjustment knob under arm pair



Globus armchair of laminated beech or birch. Stackable.

F:3b	71	Globus armchair upholstered in fabric class 1
	71	Globus armchair upholstered in fabric class 2
	71	Globus armchair upholstered in fabric class 3
	71	Globus armchair upholstered in fabric class 4
	70	Chair Globus - the same price as armchair 71

Armchair Venus of laminated beech or birch. Stackable.

	73	Armchair Venus upholstered in fabric class 1
	73	Armchair Venus upholstered in fabric class 2
	73	Armchair Venus upholstered in fabric class 3
	73	Armchair Venus upholstered in fabric class 4
	9900.07	Connector
	7110.12	Writing table top, folding-



High chair Småtroll grows with the child's development and can be adjusted without tools. The chair's construction means that depth adjustment of the seat and footrest automatically adapts when adjusting height. The distance between the cross bar and seat is constant and follows the seat up and down.

Småtroll complies with international safety and stability standards.

- | | | |
|-----|----------|---------------------------------|
| F:4 | STBL1-5 | High chair Småtroll in birch |
| | STBL-BYG | Cross bar for 'Småtroll', birch |



Mia chair with moulded seat and seatback with surface in laminate. Stackable.

- | | | |
|-----|-----|--------------------------------------------------------------------------------------------------------------------------------------------------------------------------------|
| F:5 | 190 | Mia chair height 44 cm or 48 cm
laminate in standard colours
When ordering more than 100 chairs
colours in Formica's range can be
selected.
Surcharge per chair |
|-----|-----|--------------------------------------------------------------------------------------------------------------------------------------------------------------------------------|



Suzan chair with ergonomically shaped seat and seatback of birch. Flexible floor protector. Stackable.

- | | | |
|-----|--------|-----------------------------------------------------------------|
| F:6 | 141 | Suzan chair, height 44 or 48 cm
Staining in standard colours |
| | 141 Ks | Suzan chair seat upholstered in fabric class 1 |
| | 141 Ks | Suzan chair seat upholstered in fabric class 2 |
| | 141 Ks | Suzan chair seat upholstered in fabric class 3 |
| | 141 Ks | Suzan chair seat upholstered in fabric class 4 |



Zanna chair with ergonomically shaped seat and seatback of birch. Flexible floor protector. Stackable.

- | | | |
|------|-------|-------------------------------------------------------------------------------------------------------------------|
| F:6b | 147 | Zanna chair height 44 or 48 cm
Staining in standard colours |
| | 147 K | Zanna chair upholstered seat and seatback
fabric class 1
fabric class 2
fabric class 3
fabric class 4 |



Liza chair with ergonomically shaped seat and seatback of birch. Tilts into two positions. Stackable.

- | | | |
|------|-----|--------------------------------|
| F:6c | 148 | Liza chair, height 44 or 48 cm |
|------|-----|--------------------------------|

F Chairs, stackable steel tubing chairs, upholstered chairs, stools and work chairs



Chairs with seats and seat backs of solid birch. Stackable.

F:7	145	Chair height 44 cm Surcharge for stained seat and seatback
	145Ks	Chair, seat upholstered in fabric class 1
	145Ks	Chair, seat upholstered in fabric class 2
	145Ks	Chair, seat upholstered in fabric class 3
	145Ks	Chair, seat upholstered in fabric class 4
	145K	Chair, seat and seatback upholstered in fabric class 1
	145K	Chair, seat and seatback upholstered in fabric class 2
	145K	Chair, seat and seatback upholstered in fabric class 3
	145K	Chair, seat and seatback upholstered in fabric class 4
		Connector



Chairs with seats and seat backs of solid birch. Stackable.

F:8	151	Chair height 44 or 48 cm
	234	Transport cart for stackable chairs



Chairs of plastic. Stackable.

F:9	351	Chair height 44 or 48 cm NB! New colours: blue, black, grey and transparent. Connector
-----	-----	----------------------------------------------------------------------------------------------



S Stools with round seats.

F:10	118	Height 44 or 40 cm, stackable, birch seat
	118	Height 44 or 40 cm, stackable, laminate seat
	119	Height 60 cm with footrest, birch seat
	119	Height 60 cm with footrest, laminate seat



Work chair with gas raising unit, automatic back adjustment, seat with tilt function. Back h=23 cm. School security.

F:11	310-1	Work chair upholstered with Oxford fabric
	310-2	Work chair upholstered in fabric class 2
	310-3	Work chair upholstered in fabric class 3
	310-4	Work chair upholstered in fabric class 4

Work chair with gas raising unit, automatic back adjustment, seat with tilt function. Back h=35 cm. School security

	340-1	Work chair upholstered with Oxford fabric
	340-2	Work chair upholstered in fabric class 2
	340-3	Work chair upholstered in fabric class 3
	340-4	Work chair upholstered in fabric class 4

School security included on 310 and 340.

	4701	Adjustable arm
	4801	Z-arm adjustable
	5050	Footrest hoop aluminium
	5550	Footrest, black
	5850	Footrest hoop black
	7010	Raised spindle Slow rotation wheels, loaded or unloaded - surcharge per chair Dito as accessories each Surcharge for aluminium pedestal

Work chair with gas raising unit, automatic back adjustment, seat with tilt function. Back h=40 cm.

534-1	Work chair upholstered with Oxford fabric
534-2	Work chair upholstered in fabric class 2
534-3	Work chair upholstered in fabric class 3
534-4	Work chair upholstered in fabric class 4
	Slide feet for the same price



Work chair with gas raising unit, separate handle for stepless adjustment of back and seat angle, swing function and sliding seat. Edge sewn ergonomic die cast seat and seatback.

F:12	820-1	Work chair upholstered with Oxford fabric
	820-2	Work chair upholstered in fabric class 2
	820-3	Work chair upholstered in fabric class 3
	820-4	Work chair upholstered in fabric class 4
		Chair 820 incl slide
		Slide feet for the same price
4851		Adjustable arm
		Chair 730 no longer stocked
		Optional pedestal as shown in the picture, black or aluminium.



Work chair with gas raising unit, automatic back adjustment, seat with tilt function. Seat and seatback of beech or birch. School security.

F:13	312GL	Work chair, aut height adjustment. 38-52 cm, sliders
	312HJ	Work chair, aut height adjustment. 38-52 cm, wheels
	312FGL	Work chair, aut height adjustment. 50-69 cm, slider, foot
	312FHJ	Work chair, aut height adjustment. 50-69 cm, wheels, foot
	7010	Raised spindle 50-69 cm
	5050	Footrest hoop, aluminium
	5550	Footrest, black painted
5850	Footrest hoop, black painted	
		School security included

Stool with gas raising unit, seat of beech. Wheels or slide feet.

302	Stool, aut height adjustment 38-52 cm
-----	---------------------------------------

Stool with gas raising unit, upholstered seat. Wheels or slide feet.

304-1	Stool, upholstered with Oxford fabric
304-2	Stool, upholstered in fabric class 2
304-3	Stool, upholstered in fabric class 3
304-4	Stool, upholstered in fabric class 4



Work stool with gas raising unit

F:14	516-1	Low chair Star without back, standard upholstery, low gas 30-38 cm, wheels
	525-1	Low chair Star with T-back, standard upholstery, low gas 30-38 cm wheels
	616-1	High chair Unik without back, standard upholstery, extra high gas 52-76 cm, protective studs
	625-1	High chair Unik with back, standard upholstery, extra high gas 52-76 cm, protective studs



Scania (beech)

G2

Sofa suite Scania in beech with rib bottom.

Fully removable upholstery.

Padded with cold cured PU foam.

NB! sides not upholstered!

Height 83 cm

Seat height 45 cm

Depth 78 cm.

Seat depth 51 cm



Low end piece

G2 Sofas and armchairs

- 3101 Armchair b=79 cm
- 3102 2-seat sofa b=136 cm
- 3103 3-seat sofa b=194 cm
- 3109 Surcharge for upholstered arms – pair
- 3110 Surcharge for upholstered end pieces – pair

Corner sofas

- 3111 1-seat module b=59 cm
- 3112 2-seat module b=116 cm
- 3113 3-seat module b=174 cm
- 3130 rounded corner section 102x102 cm
- 3140 angled corner section 84x84 cm
- 3120 arm support end piece b=10 cm – pair
- 3121 low end piece b=5 cm - pair

Extended zip/cushion
 Solid bottom in 7 mm plywood, armchair
 2-seat
 3-seat

Coffee table

- 3106 Coffee table Triss 120x75 h=58 cm, beech
- 3107 Coffee table Triss 75x75 h=55 cm, beech

Other coffee tables - see page 31



G2c

Sofa suite Scania in birch with rib bottom.
Fully removable upholstery.
Padded with cold cured PU foam.

Height 83 cm
Seat height 45 cm
Depth 78 cm.
Seat depth 51 cm



G2c Sofas and armchairs

3201	Armchair b=79 cm
3202	2-seat sofa b=136 cm
3203	3-seat sofa b=194 cm
3209	Surcharge for upholstered arms – pair
3210	Surcharge for upholstered end pieces – pair

Corner sofas

3211	1-seat module b=59 cm
3212	2 -seat module b=116 cm
3213	3-seat module b=174 cm
3230	rounded corner section 102x102 cm
3240	angled corner section 84x84 cm
3220	arm support end piece b=10 cm – pair
3221	low end piece b=5 cm - pair

Extended zip/cushion
Solid bottom in 7 mm plywood, armchair
2-seat
3-seat

Coffee table

3206	Coffee table Triss 120x75 h=58 cm, birch
3207	Coffee table Triss 75x75 h=55 cm, birch

Other coffee tables - see page 31



G3
Sofa suite Sommen with shell of solid wood with nozag bottom. Cushions with removable upholstery. Padded with cold cured PU foam. Legs of beech or birch.

Height 82 cm
Seat height 45 cm
Depth 78 cm.
Seat depth 51.5 cm

Sommen 3236 4103+4110+4102

G3 Sofas and armchairs

4101	Armchair b=86 cm
4102	2-seat sofa b=150 cm
4103	3-seat sofa b=188 cm

Corner sofas

4110	corner section 100x100 cm
4111	1-seat module b=54 cm
4112	2-seat module b=106 cm
4113	3-seat module b=156 cm
4114	End piece b=15 cm – pair

Extended zip/cushion

Surcharge for fixed bottom	armchair
	2-seat
	3-seat
	corner section

Coffee table Fia in solid beech or birch

3235	110x65 cm, h=58 cm
3236	130x80 cm, h=58 cm

Several sizes – see page 31



Corona

G3b
Sofa suite Corona with shell of solid wood with nozag bottom. Cushions with removable upholstery. Padded with cold cured PU foam. Wood inlaid arm and legs of beech or birch.

Height 82 cm
Seat height 45 cm
Depth 78 cm.
Seat depth 51.5 cm

4201 3604 4203+4210+4202

G3b Sofas and armchairs

4201	Armchair b=74 cm
4202	2-seat sofa b=137 cm
4203	3-seat sofa b=176 cm

Corner sofas

4210	corner section 100x100 cm
4211	1-seat module b=54 cm
4212	2-seat module b=106 cm
4213	3-seat module b=156 cm
4214	End piece b=9 cm – pair

Extended zip/cushion

Surcharge for fixed bottom	armchair
	2-seat
	3-seat
	corner section

Coffee table in solid beech or birch

3604	Comet ellipse 138x72 cm, h=50 cm
3605	Orbit Ø 60 cm, h=50 cm

Coffee table Fia in solid beech or birch

3235	110x65 cm, h=58 cm
3236	130x80 cm, h=58 cm

Several sizes – see page 31



G3c

Sofa suite Keno with shell of solid wood with nozag bottom. Cushions with removable upholstery. Padded with cold cured PU foam. Legs of beech or birch.

Height 84 cm

Seat height 45 cm

Depth 78 cm.

Seat depth 51.5 cm

G3c Sofas and armchairs

4301	Armchair b=80 cm
4302	2-seat sofa b=143 cm
4303	3-seat sofa b=182 cm

Corner sofas

4310	corner section 100x100 cm
4311	1-seat module b=54 cm
4312	2-seat module b=106 cm
4313	3-seat module b=156 cm
4314	End piece b=15 cm – pair

Extended zip/cushion

Surcharge for fixed bottom	armchair
	2-seat
	3-seat
	corner section

Coffee table Fia in solid beech or birch

3235	110x65 cm, h=58 cm
3236	130x80 cm, h=58 cm

Several sizes – see page 31

Casino



Sofa suite Casino with shell of solid wood with nozag bottom. All upholstery on both shell and cushions is fully removable, cover with extended zips. Padded with cold cured PU foam. Legs of beech or birch.

Height 82 cm

Seat height 45 cm

Depth 82 cm.

Seat depth 51.5 cm

Sofas and armchairs

3301	Armchair b=87 cm
3302	2-seat sofa b=143 cm
3303	3-seat sofa b=200 cm

Corner sofas

3310	corner section 100x100 cm
3311	1-seat module b=57 cm
3312	2-seat module b=113 cm
3313	3-seat module b=170 cm
3314	End piece b=15 cm – pair

Extended zip/cushion

Surcharge for fixed bottom	armchair
	2-seat
	3-seat
	corner section

Coffee table - see page 31

Cecilia



Sofa suite Cecilia with shell of solid birch.
Cushions with removable upholstery, incl extended zip.
Padded with cold cured PU foam.
3-seat sofa Cecilia functions also as a bed.

Height 82 cm
Seat height 45 cm
Depth 82 cm
Seat depth 51.5 cm

Sofas and armchairs

- 3701 Armchair b=70 cm
- 3702 2-seat sofa b=135 cm
- 3703 3-seat sofa b=200 cm

Corner sofas

- 3709 Angled corner 83x83 cm
- 3710 Round corner 98x98 cm
- 3711 1-seat module b=64 cm
- 3712 2-seat module b=129 cm
- 3713 3-seat module b=194 cm
- 3714 End piece b=3 cm with side cushions – pair
Surcharge for continuous cushion (2nd and 3rd)

Coffee table - see page 31

Rhapsody



Sofa suite Rhapsody with steel tubing legs in silver.
Moulded back, fixed back and seat with padding
of cold cured PU foam.

Height 80 cm
Seat height 45 cm
Depth 63 cm
Seat depth 46 cm

Sofa suite

- 4501 Armchair b=59 cm
- 4502 2-seat sofa b=127 cm

Coffee table - see page 31

Poker



Poker sofa with shell of birch. All upholstery removable,
padding of cold cured PU foam.

Height 77 cm
Seat height 45 cm
Depth 74 cm
Seat depth 51 cm

Sofa

- 4803 Sofa l=192 cm

Coffee table - see page 31

Retro



Sofa suite Retro with wood shell and nozag bottom, padding of cold cured PU foam. Reversible cushions. Fully removable upholstery. Lathed leg in beech or birch with adjustable foot.

Height 79 cm
Seat height 42/45 cm, depth 80 cm,
High armchair height 102 cm,
depth 90 cm.

Armchair

4901 Armchair with low back, b=80 cm
4911 Armchair with high back, b=80 cm

Sofas

4902 2-seat sofa b=136 cm
4903 3-seat sofa b=190 cm

Bia



Optional height of arm and middle leg

Sofa suite Bia with shell of steel tubing in silver or black. Compression moulded seat element in plyfa with padding of cold cured PU foam. Fully removable upholstery. Can be supplied with arm hoops or low end pieces. Table in birch, rectangular 42x49 cm and pivoted 45° (can be assembled as 'pivoted in' or 'pivoted out').

Height 75 cm
Seat height 44 cm
Depth 72 cm.
Seat depth 48 cm



Bia with connecting table

G:3d Sofa suite



*Footstool,
1 and 2-seat*

4401 Armchair b=58 cm
4402 Sofa with 2 seat baskets, b=113 cm
4403 Sofa with 3 seat baskets, b=168 cm
4410 Footstool, 1-seat b=58 cm
4420 Footstool, 2-seat b=113 cm
4430 Footstool, 3-seat b=168 cm
4412 1-s + rectangular table +1-s
4422 1-s + 45° table +1-s
4414 2-s + rectangular table +2-s
4424 2-s + 45° table +2-a
4416 3-s + rectangular table + 3-s
4426 3-s + 45° table + 3-s
4436 2-s + rectangular table + 2-s + rectangular table + 2-s
4446 2-s + 45° table + 2-s + 45° table + 2-s

4411 New seat basket
4421 Arm – pair, high or low
4422 Middle leg, high or low
4409 Arm boards in birch or beech, pair

Connecting table

Table in birch incl 2 middle legs:
4431 Rectangular 42x49 cm
4432 45° 'pivoted' b=55/21 x d=50.5 cm

Coffetable Uno with table top of solid birch or beech, steel tubing legs in silver or black.

4404 110x65 cm, h=58 cm
4405 130x80 cm, h=58 cm
4406 Ø 70 cm, h=58 cm
4407 Ø 90 cm, h=58 cm

Sofa suite Edge with shell in plywood and foam and padded with cold cured PU foam. Removable upholstery. Fixed seat cushions as option. Legs in birch, beech or silver.

Height 77 cm
 Seat height 46 cm
 Depth 70 cm
 Seat depth 52 cm

Edge



4620



Armchairs and Sofas

- 4601 Armchair without arm, b=70 cm
- 4611 Armchair with 1 arm, b=70 cm

- 4602 2-seat sofa without arm, b=160 cm
- 4612 2-seat sofa with 1 arm, b=160 cm
- 4622 2-seat sofa with 2 arm, b=160 cm

- 4603 3-seat sofa without arm, b=200 cm
- 4613 3-seat sofa with 1 arm, b=200 cm
- 4623 3-seat sofa with 2 arm, b=200 cm

Corner sofas

- 4610 Corner section 70x70 cm
- 4620 Love seat, b=200 cm

- Corner sofas with arm:
- 4653 1-seat+corner+2-seat (140x230 cm)
- 4654 2-seat+corner+2-seat (230x230 cm)
- 4655 2-seat+corner+3-seat (230x270 cm)
- 4656 3-seat+corner+3-seat (270x270 cm)
- 4666 2-s+c+2-s+c+2-s (230x300x230 cm)
- 4667 2-s+c+3-s+c+2-s (230x340x230 cm)

- Corners sofas without arm:
- 4673 1-seat+corner+2-seat (140x230 cm)
- 4674 2-seat+corner+2-seat (230x230 cm)
- 4675 2-seat+corner+3-seat (230x270 cm)
- 4676 3-seat+corner+3-seat (270x270 cm)
- 4686 2-s+c+2-s+c+2-s (230x300x230 cm)
- 4687 2-s+c+3-s+c+2-s (230x340x230 cm)

- Additional - fixed seat cushion

 - 1-seat
 - 2-seat
 - 3-seat
 - corner section

Coffee table - see page 31



Triss

Fia

Uno

Pepita

Coffee table Triss of solid beech

3106	120x75 cm, h=58 cm
3107	75x75 cm, h=55 cm

Coffee table Triss of solid birch

3206	120x75 cm, h=58 cm
3207	75x75 cm, h=55 cm

Coffee table Fia in solid beech or birch.

3235	110x65 cm, h=58 cm
3236	130x80 cm, h=58 cm
3237	Ø 90 cm, h=58 cm, 4 legs
3238	40x65 cm, h=53 cm
3239	ellipse 110x70 cm, h=58 cm
3240	triangular 95x95 cm, h=58 cm
3241	triangular 115x115 cm, h=58 cm
3257	Ø 70 cm, h=58 cm, pedestal frame
3258	Ø 90 cm, h=58 cm, pedestal frame

Coffee table Uno with table top of solid birch or beech, steel tubing legs in silver or black.

4404	110x65 cm, h=58 cm
4405	130x80 cm, h=58 cm
4406	Ø 70 cm, h=58 cm
4407	Ø 90 cm, h=58 cm

Coffee table Pepita with table top of solid birch. Steel tubing legs in silver.

4504	110x65 cm, h=58 cm
4505	ellipse 110x70 cm, h=58 cm
4506	Ø 70 cm, h=58 cm



Samskap

Sofa suite Samskap with shell of veneered lock board and edging of wood. Padded with cold cured PU foam. The cushions are screw fixed.

Height 90 cm
Seat height 42 cm
Depth 70 cm.

Samskap in beech:

841	Straight, length 60 cm
842	Straight, length 120 cm
843	Straight, length 150 cm
844	Straight, length 180 cm
845	Curved 1/4-round, radius 140 cm
846	Corner 70x70 cm

Samskap in birch:

851	Straight, length 60 cm
852	Straight, length 120 cm
853	Straight, length 150 cm
854	Straight, length 180 cm
855	Curved 1/4-round, radius 140 cm
856	Corner 70x70 cm



G5 b,c

Sofa suite Ritz with shell of veneered birch chipboard and plywood bottom. Legs of steel tubing in silver. Flexible floor protector. Padding of cold cured PU foam with removable upholstery.

Height 80 cm, seat height 43 cm, depth 74 cm.

Coffee table Ritz with 36 mm birch veneered table top. Frame of 40 mm steel tubing in silver, 4 wheels.

Sofas	432	2-seat sofa b=149 cm
	433	3-seat sofa b=204 cm
Coffee table	434	table 120x80 cm, h=58 cm
	435	table 60x60 cm, h=58 cm
Armchair	431	Armchair b=82 cm
Corner sofas	430 22	2-seat + corner + 2-seat (240x240 cm)
	430 23	2-seat + corner + 3-seat (240x295 cm)
	430 32	3-seat + corner + 2-seat (295x240 cm)
	430 33	3-seat + corner + 3-seat (295x295 cm)



G6

Suite Corridor with wood details of laminated beech. Frame of black painted steel tubing. (supplied unassembled)

Sofa depth 56 cm, seat height 42 cm, total height 77 cm:	3401	length 100 cm
	3402	length 140 cm
	3403	length 210 cm
Bench depth 39 cm, seat height 42 cm:	3411	length 100 cm
	3412	length 140 cm
	3413	length 210 cm
Corner sofa 56 cm, seat height 42 cm, total height 77 cm: <i>(inner measurements/total measurements – left/right as sitting on sofa):</i>	3416	left 100/156 cm + right 100/156 cm
	3417	left 100/156 cm + right 140/196 cm
	3418	left 140/196 cm + right 100/156 cm
	3419	left 100/156 cm + right 210/266 cm
	3420	left 210/266 cm + right 100/156 cm
	3421	left 140/196 cm + right 140/196 cm
	3422	left 140/196 cm + right 210/266 cm
	3423	left 210/266 cm + right 140/196 cm
	3424	left 210/266 cm + right 210/266 cm
	Corridor table:	3425
3426		120x80 cm, h=73 cm
3427		160x80 cm, h=73 cm
Accessories:	3430	Fitting for attaching to floor, each



G7

Suite Magnarp with wood details of solid birch. Frame of black painted steel tubing. (supplied unassembled)

G7 Sofa depth 56 cm, seat height 42 cm, total height 77 cm:

3451	length 100 cm
3452	length 140 cm
3453	length 210 cm

Bench depth 39 cm, seat height 42 cm:

3461	length 100 cm
3462	length 140 cm
3463	length 210 cm

Magnarp table:

3475	80x80 cm, h=73 cm
3476	120x80 cm, h=73 cm
3477	160x80 cm, h=73 cm

Accessories:

3430	Fitting for attaching to floor, each
------	--------------------------------------



G7b

Pupil sofa Zoom of moulded MDF overlaid with high pressure laminate K 7024 birch. Black frame. Height 72 cm, seat height 42 cm, depth 55 cm

Sofas

348 24 12	length 120 cm
348 24 18	length 180 cm

349 99 12	length 120 cm, padded and upholstered seat
349 99 18	length 180 cm, padded and upholstered seat

Drilling for floor attachment - per sofa

Coffee table Café, 25 mm table top with high pressure laminate K 7024 birch. Black frame

245 24 77	70x70 cm, h=58 or 72 cm
245 24 27	120x70 cm, h=58 or 72 cm



G7d

Sofa suite Linien with frame of painted steel tubing, T-foot. Seat and seatback in 3 different versions.

Height 83 cm,
Seat height 45 cm,
Depth 61 cm.

G7d Sofa

2355.10	Sofa 120 cm, plywood in beech or birch with groove
2365.10	Sofa 180 cm, plywood in beech or birch with groove
2370.10	Sofa 120 cm, rubber coated plywood
2375.10	Sofa 180 cm, rubber coated plywood

2385.1.	Sofa 120 cm, padded and upholstered seats
2380.1.	Sofa 180 cm, padded and upholstered seats <i>Seatback plywood in beech or birch with groove on upholstered sofas. Available also with upholstered back.</i>

Accessories:

9900.35	Connection table Ø 50 cm in beech or birch, adjustable for each 22.5°
9900.45	Arm in steel piping – each (extends 3 cm between sofas)
9900.40	Connection tubing for connection between arm
9900.50	Extra table bracket



G8

Changing room benches with black frame* square tubing and wood details of pine, 3 seat widths wide
Clothes hook boards supplied loose with unassembled clothes hooks, type Ferhllins 1040, 7 per meter.
Floor protectors of plastic or floor bracket for attaching to the floor (specified when ordered).

*Grey, warm white, dark red, dark blue and sky blue available as option.
Other lengths can be supplied on request.

Changing room bench, double, seat height 425 mm, seat depth 360+360 mm, total depth 760 mm, total height 1640 mm:

BNK5-1000	length 1,000 mm, two leg pairs
BNK5-2000	length 2,000 mm, two leg pairs (=702)
BNK5-3000	length 3,000 mm, three leg pairs

Changing room bench, single, seat height 425 mm, seat depth 360 mm, total depth 390 mm, total height 1,640 mm:

BNK4-1000	length 1,000 mm, two leg pairs
BNK4-2000	length 2,000 mm, two leg pairs (=704)
BNK4-3000	length 3,000 mm, three leg pairs

Seat bench, seat height 425 mm, seat depth=360 mm:

BNK1-1000	length 1,000 mm, two leg pairs (=705)
BNK1-2000	length 2,000 mm, two leg pairs (=707)
BNK1-3000	length 3,000 mm, three leg pairs

Seat bench, seat height 425 mm, seat depth=360 mm with shoe shelf:

BNK2-1000	length 1,000 mm, two leg pairs (=708)
BNK2-2000	length 2,000 mm, two leg pairs (=710)
BNK2-3000	length 3,000 mm, three leg pairs

Clothes hook board with school hooks type 1040:

KRL2-1000	length 1,000 mm, 7 hooks (=712)
KRL2-2000	length 2,000 mm, 14 hooks (=714)
KRL2-3000	length 3,000 mm, 21 hooks

Wall mounted bench on strong brackets, brackets fixed to wall with bolt. Seat depth 385 mm:

BNK3-1000	length 1,000 mm, two brackets (=715)
BNK3-2000	length 2,000 mm, three brackets (=717)
BNK3-3000	length 3,000 mm, four brackets



VSK2000

Available in 15 different colours:

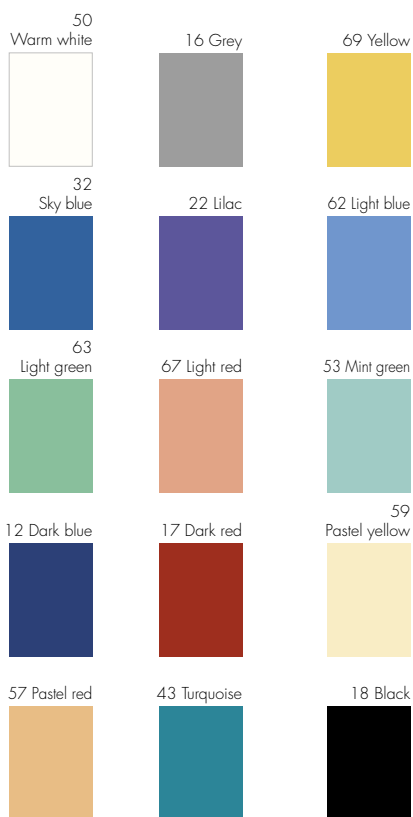

Cloakroom fittings BST of width 200 mm in section lengths of 600, 800 and 1,000 mm and of width 300 mm in section lengths of 600 and 900 mm. All units have fittings for mounting on wall rails.

G:9	KPH02	Coat shelf 60 cm with partition
	KPH03	Coat shelf 90 cm with partition
	HTH02U	Hat shelf 60 cm without partition
	HTH03U	Hat shelf 90 cm without partition
	HTH03U-2	Hat shelf 60 cm without partition
	HTH04U-2	Hat shelf 80 cm without partition
	HTH05U-2	Hat shelf 100 cm without partition
	HTH02M	Hat shelf 60 cm, 2 bay
	HTH03M	Hat shelf 90 cm, 3 bay
	HTH03M-2	Hat shelf 60 cm, 3 bay
	HTH04M-2	Hat shelf 80 cm, 4 bay
	HTH05M-2	Hat shelf 100 cm, 5 bay
	SKH02U	Shoe shelf 60 cm without partition
	SKH03U	Shoe shelf 90 cm without partition
	SKH03U-2	Shoe shelf 60 cm without partition
	SKH04U-2	Shoe shelf 80 cm without partition
	SKH05U-2	Shoe shelf 100 cm without partition
	SKH02M	Shoe shelf 60 cm, 2 bay
	SKH03M	Shoe shelf 90 cm, 3 bay
	SKH03M-2	Shoe shelf 60 cm, 3 bay
	SKH04M-2	Shoe shelf 80 cm, 4 bay
	SKH05M-2	Shoe shelf 100 cm, 5 bay

Benches in combination with shoe shelf:

BNK02	Bench 60 cm
BNK03	Bench 90 cm
BNK04-2	Bench 80 cm
BNK05-2	Bench 100 cm

Benches which can be assembled without shoe shelf:

BNKF02	Bench 60 cm
BNKF03	Bench 90 cm
BNKF04-2	Bench 80 cm
BNKF05-2	Bench 100 cm
DRP02	Drop plate steel 60 cm
DRP03	Drop plate steel 90 cm
DRP04-2	Drop plate steel 80 cm
DRP05-2	Drop plate steel 100 cm
KRL02	Hook plate 60 cm
KRL03	Hook plate 90 cm
KRL04-2	Hook plate 80 cm
KRL05-2	Hook plate 100 cm
KRLV02	Hook plate 60 cm
KRLV03	Hook plate 90 cm
KRLV04-2	Hook plate 80 cm
KRLV05-2	Hook plate 100 cm
HYL60	Shelf 60 cm, incl brackets
HYL90	Shelf 90 cm, incl brackets
HYL80	Shelf 80 cm, incl brackets
HYL100	Shelf 100 cm, incl brackets
VSK 800	Wall rail 80 cm
VSK2000	Wall rail 200 cm
E-G	Single gondola
D-G	Double gondola
MS-600	Middle strut 584 mm
MS-900	Middle strut 883 mm
MS-800-2	Middle strut 784 mm
MS-1000-2	Middle strut 993 mm

H Drawer units, cupboards, book shelves, wall shelves, pupil cupboards, teacher pigeon holes, library fittings, sheet steel cupboards



Materials cupboard

Tall cupboard

Shell and doors of 19 mm chipboard. Shelves in block board with edging of solid wood. Rebated doors with 15 mm wood edging. Espagnolette with handle including Abloy cylinder lock on doors.

Self closing cast hinges with 180° opening angle.

Fitted base, height 100 mm.



111 000



111 010



111 030



111 040



111 054



111 070



111 083



111 400



111 500



111 500.
(30,45 or 60)
/50

Depth 300 mm. Width 1,000 mm, height 2,100 mm. (Incl base). Beech or birch.

- 111 040.30 Materials cupboard with partition. 8 movable half shelves.
- 111 070.30 Materials cupboard with partition. 14 movable half shelves.
- 111 400.30 Materials cupboard with 1 fixed shelf. 3 movable shelves. (See A:3;121 400.30, the same cupboard with glazed doors)
- 111 500.30 Materials cupboard with 1 fixed shelf. 4 movable shelves.
- 111 500.30/50 Materials cupboard, width 500 mm with 1 fixed shelf. 4 movable shelves. Right hung door.

Depth 450 mm. Width 1,000 mm, height 2,100 mm. (Incl base). Beech or birch.

- 111 000.45 Wardrobe with clothes rail.
- 111 010.45 Wardrobe with partition, 2 movable half shelves. Clothes rail.
- 111 030.45 Changing room cupboard with partition, 6 movable half shelves. Clothes rail.
- 111 040.45 Materials cupboard with partition. 8 movable half shelves.
- 111 054.45 Tools cupboard with partition, 10 half shelves and 8 drawers in plastic.
- 111 070.45 Materials cupboard with partition. 14 movable half shelves.
- 111 083.45 Materials cupboard for music with 5 movable shelves. 6 plastic drawers. Double storage bay at bottom.
- 111 400.45 Materials cupboard with 1 fixed shelf. 3 movable shelves. (See A:3;121 400.45, the same cupboard with glazed doors)
- 111 500.45 Materials cupboard with 1 fixed shelf. 4 movable shelves.
- 111 500.45/50 Materials cupboard, width 500 mm with 1 fixed shelf. 4 movable shelves. Right hung door.

Depth 600 mm. Width 1,000 mm, height 2,100 mm. (Incl base). Beech or birch.

- 111 000.60 Wardrobe with clothes rail.
- 111 010.60 Wardrobe with partition, 2 movable half shelves. Clothes rail.
- 111 030.60 Changing room cupboard with partition, 6 movable half shelves. Clothes rail.
- 111 040.60 Materials cupboard with partition. 8 movable half shelves.
- 111 054.60 Tools cupboard with partition, 10 half shelves. 8 plastic drawers.
- 111 070.60 Materials cupboard with partition and 14 movable half shelves.
- 111 400.60 Materials cupboard with 1 fixed shelf. 3 movable shelves. (See A:3, 121 400.60, the same cupboard with glazed doors)
- 111 500.60 Materials cupboard with 1 fixed shelf. 4 movable shelves.
- 111 500.60/50 Materials cupboard, width 500 mm with 1 fixed shelf. 4 movable shelves. Right hung door.

Tall cupboard



Materials cupboard

Shell and doors of 19 mm chipboard. Shelves in block board with edging of solid wood. Rebated doors with 15 mm wood edging. Espagnolette with handle incl. Abloy cylinder lock on doors. Self closing cast hinges with 180° opening angle. Fitted base, height 100 mm.

Depth 300 mm. Width 1,000 mm, height 2,100 mm. (Incl base). Beech or birch.

111 600.30 Materials cupboard with 1 fixed shelf. 5 movable shelves.

111 700.30 Materials cupboard with 1 fixed shelf. 6 movable shelves.

Depth 450 mm. Width 1,000 mm, height 2,100 mm. (Incl base). Beech or birch

111 600.45 Materials cupboard with 1 fixed shelf. 5 movable shelves.

111 700.45 Materials cupboard with 1 fixed shelf. 6 movable shelves.

111 901.45 Materials cupboard with clothes rail, 3 movable half shelves. 16 form bays in plastic.

111 902.45 Music cupboard with partition, 2 form bays, half shelf. 2 plastic drawers. 1 movable shelf.

111 904.45 Materials cupboard for fabrics with 1 fixed shelf. 7 shelves with expansion.

111 905.45. Tools cupboard with 5 movable shelves of which 3 are inclined.

111 907.45 Ball cupboard with 5 movable lattice shelves.

111 918.45 Sewing equipment cupboard with wool bays, form bays 16 plastic drawers with 164 module drawers.

111 908.45 Skeleton cupboard with partition, 4 movable 1/3-shelves. Right section without base.

Depth 600 mm. Width 1,000 mm, height 2,100 mm. (Incl base). Beech or birch

111 600.60 Materials cupboard with 1 fixed shelf and 5 movable shelves.

111 700.60 Materials cupboard with 1 fixed shelf and 6 movable shelves.

111 904.60 Materials cupboard for fabrics with 1 fixed shelf. 7 shelves with expansion.

111 908.60 Skeleton cupboard with partition, 4 movable 1/3-shelves. Right section without base.

800 H.60 Mattress cupboard with 10 bays for mattresses and 10 pillow bays.

800 H.60/50 Mattress cupboard, width 500 mm, with 5 bay for mattresses and 5 pillow bays. Right hung door.

800 I.60 Mattress cupboard with 3 bays for mattresses and 1 pillow bay.

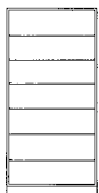

111 600



111 700

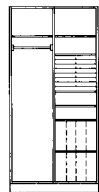

111 901

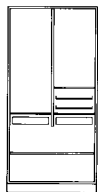

111 902



111 904



111 905



111 907



111 908



111 918



800 H



800 H.60/50

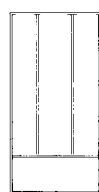

800 I.60

80
80

H Drawer units, cupboards, book shelves, wall shelves, pupil cupboards, teacher pigeon holes, library fittings, sheet steel cupboards



Pupil and materials cupboard

Tall cupboard

Shell and doors of 19 mm chipboard. Shelves in block board with edging of solid wood. Glass doors fitted with hardened glass and with solid wood frame. Rebated doors with 15 mm wood edging. Espagnolette with handle incl. Abloy cylinder lock on doors 1,200 mm and higher. Lower doors with wood handle. These doors can, on payment of a surcharge, be supplied with cylinder locks. Self closing cast hinges with 180° opening angle. Fitted base, height 100 mm.



191 911



191 912



121 400
glass doors



210 021+
411 902



210 032+
411 012



210 200+
411 100



210 300+
411 200



210 400+
411 006

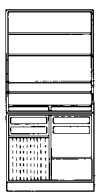

210 400+
411 012

Depth 300 mm Width 1,000 mm, height 2,100 mm. (Incl base). Beech or birch.

- 121 400.30 Materials cupboard with 1 fixed shelf. 3 movable shelves, glazed doors
- 210 200+ Materials cupboard with 1 fixed shelf. 2 movable shelves in upper section.
- 411 100.30 1 movable shelf in lower section.
- 210 300+ Materials cupboard with 1 fixed shelf. 3 movable shelves in upper section.
- 411 200.30 2 movable shelves in lower section.

Depth 450 mm Width 1,000 mm, height 2,100 mm. (Incl base). Beech or birch.

- 191 911.45 Pupil cupboard with 4 double doors incl lock. 3 fixed and 4 movable shelves.
- 191 912.45 Pupil cupboard with partition, 3 double doors incl lock. 2 fixed shelves and 6 movable half shelves.
- 121 400.45 Materials cupboard with 1 fixed shelf. 3 movable shelves, glazed doors.
- 210 021+ Materials cupboard with partition, 3 half shelves, 2 drawers in plastic in upper section and 2 movable lattice shelves in lower section.
- 210 032+ Materials cupboard with partition. 8 movable half shelves.
- 411 012.45 8 drawers in plastic of which 4 in lower section.
- 210 200+ Materials cupboard with 1 fixed shelf. 2 movable shelves in upper section.
- 411 100.45 1 movable shelf in lower section.
- 210 300+ Materials cupboard with 1 fixed shelf. 3 movable shelves in upper section and 2 movable shelves in lower section.
- 411 200.45 2 movable shelves in lower section.
- 210 400+ Materials cupboard with 4 movable shelves in upper section.
- 411 006.45 12 drawers in plastic in lower section.

- 210 400+ Drawing cupboard with 4 movable shelves in upper section.
- 411 012.45 Partition, 1 half shelf, 4 plastic drawers in lower section. (Excluding drawing boards and edging)

Depth 600 mm Width 1,000 mm, height 2,100 mm. (Incl base). Beech or birch.

- 191 911.60 Pupil cupboard with 4 double doors incl lock. 3 fixed and 4 movable shelves.
- 191 912.60 Pupil cupboard with partition, 3 double doors incl lock. 2 fixed shelves and 6 movable half shelves.
- 121 400.60 Materials cupboard with 1 fixed shelf. 3 movable shelves, glazed doors.
- 210 200+ Materials cupboard with 1 fixed shelf. 2 movable shelves in upper section.
- 411 100.60 1 movable shelf in lower section.
- 210 300+ Materials cupboard with 1 fixed shelf. 3 movable shelves in upper section.
- 411 200.60 2 movable shelves in lower section.
- FU lock Lock for lower cupboard



Materials cupboard

Tall cupboard

Shell and doors of 19 mm chipboard. Shelves in block board with edging of solid wood. Glass doors fitted with hardened glass and with solid wood frame. Rebated doors with 15 mm wood edging. Espagnolette with handle incl. Abloy cylinder lock on doors 1,200 mm and higher. Lower doors with wood handle. These doors can, on payment of a surcharge, be supplied with cylinder locks. Self closing cast hinges with 180° opening angle. Fitted base, height 100 mm.

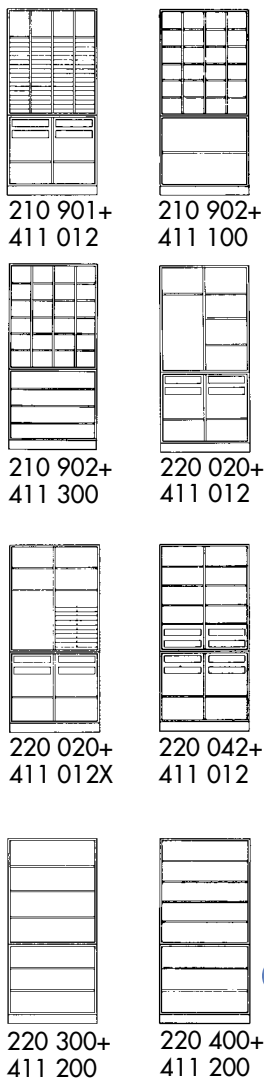

Depth 300 mm Width 1,000 mm, height 2,100 mm. (Incl base). Beech or birch.

220 300+
411 200.30 Materials cupboard with 1 fixed shelf. 3 movable shelves and glazed doors in upper section. 2 movable shelves and air tight doors in lower section.

220 400+
411 200.30 Materials cupboard with 1 fixed shelf. 4 movable shelves and glazed doors in upper section. 2 movable shelves and air tight doors in lower section.

Depth 450 mm Width 1,000 mm, height 2,100 mm. (Incl base). Beech or birch.

210 901+
411 012.45 Form cupboard with 80 form bays in upper section. Lower section with partition, 4 plastic drawers and 2 half shelves.

210 902+
411 100.45 Materials cupboard with 24 wool bays in upper section 1 movable shelf in lower section.

210 902+
411 300.45 Materials cupboard with 24 wool bays in upper section 3 movable shelves in lower section.

220 020+
411 012.45 Materials cupboard with partition. 4 movable half shelves and glazed doors in upper section. 2 movable half shelves and 4 drawers of plastic in lower section. Air tight doors in lower section.

220 020+
411 012X.45 Materials cupboard with partition. 4 movable half shelves. 16 form bays and glazed doors in upper section. 2 movable half-shelves and 4 plastic drawers Air tight doors in lower section.

220 042+
411 012.45 Materials cupboard with partition and 8 plastic drawers. 8 movable half shelves and glazed doors in upper section. 2 movable half shelves, air tight doors in lower section.

220 300+
411 200.45 Materials cupboard with 1 fixed shelf, 3 movable shelves and glazed doors in upper section. 2 movable shelves and air tight doors in lower section.

220 400+
411 200.45 Materials cupboard with 1 fixed shelf, 4 movable shelves and glazed Doors in upper section. 2 movable shelves and air tight doors in lower section.

Depth 600 mm Width 1,000, height 2,100 mm. (Incl base). Beech or birch.

220 300+
411 200.60 Materials cupboard with 1 fixed shelf. 3 movable shelves and glazed doors in upper section. 2 movable shelves and air tight doors in lower section.

220 400+
411 200.60 Materials cupboard with 1 fixed shelf. 4 movable shelves and glazed doors in upper section. 2 movable shelves and air tight doors in lower section.

FU lock Lock for lower cupboard

S 80

80

H Drawer units, cupboards, book shelves, wall shelves, pupil cupboards, teacher pigeon holes, library fittings, sheet steel cupboards



Materials cupboard

Tall cupboard

Shell and doors of 19 mm chipboard. Shelves in block board with edging of solid wood. Glass doors fitted with hardened glass and with solid wood frame. Rebated doors with 15 mm wood edging. Espagnolette with handle incl. Abloy cylinder lock on doors 1,200 mm and higher. Lower doors with wood handle. These doors can, on payment of a surcharge, be supplied with cylinder locks. Self closing cast hinges with 180° opening angle. Fitted base, height 100 mm.



220 300+
421 200



220 901+
411 012



200 300.30
411 200.45



220 300+
411 200.30

80



220 400.30
411 200.45



220 300.30
421 200.45



220 400+
411 200.30

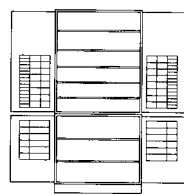

210 500+
411 200



210 500
411 200

Depth 300 mm. Width 1,000 mm, height 2,100 mm. (Incl base). Beech or birch.

220 300+ 421 200.30 Materials cupboard with 1 fixed shelf. 3 movable shelves and glazed doors in upper section. 2 movable shelves and glazed doors in lower section.

220 300+ 411 200.30 Materials cupboard with 1 fixed shelf. 3 movable shelves and glazed doors in upper section. 2 movable shelves and air tight doors in lower section.

220 400+ 411 200.30 Materials cupboard with 1 fixed shelf. 4 movable shelves and glazed doors in upper section, 2 movable shelves and air tight doors in lower section.

210 500+ 411 200.30 Sewing equipment cupboard with 72 termotex drawers on the doors. 5 movable doors in upper section. 2 movable shelves in lower section. (810Y.30)

Depth 450 mm. Width 1,000 mm, height 2,100 mm. (Incl base). Beech or birch.

220 300+ 421 200.45 Materials cupboard with 1 fixed shelf. 3 movable shelves and glazed doors in upper section. 2 movable shelves and glazed doors in lower section.

220 901+ 411 012.45 Materials cupboard with partition. 80 form bays and glazed doors in upper section. 4 plastic drawers and 2 movable half shelves air tight doors in lower section.

210 500+ 411 200.45 Sewing equipment cupboard with 72 termotex drawers on the doors. 5 movable doors in upper section. 2 movable shelves in lower section. (810Y.45)

Depth 600 mm. Width 1,000 mm, height 2,100 mm. (Incl base). Beech or birch.

220 300+ 421 200.60 Materials cupboard with 1 fixed shelf. 3 movable shelves and glazed doors in upper section. 2 movable shelves and glazed doors in lower section.

Split cupboard Upper section: Width 1,000 mm. Height 1,200 mm. Beech or birch.
Lower section: Width 1,000 mm. Height 900 mm (Incl base)

200 300.30+ 411 200.45 Materials cupboard with 1 fixed shelf. 3 movable shelves without doors in upper section with depth 300 mm. 2 movable shelves and air tight doors in lower section with depth 450 mm.

200 300.45+ 411 200.60 Materials cupboard with 1 fixed shelf. 3 movable shelves without doors in bookshelf upper section, depth 450 mm. 2 movable shelves and air tight doors in lower section. Lower section with depth 600 mm.

220 400.30+ 411 200.45 Materials cupboard with 1 fixed shelf. 4 movable shelves and glazed doors in upper section, depth 300 mm. 2 movable shelves and air tight doors in lower section, depth 450 mm

220 300.30+ 421 200.45 Materials cupboard with 1 fixed shelf. 3 movable shelves and glazed doors in upper section, depth 300 mm. 2 movable shelves and glazed doors in lower section, depth 450 mm

FU lock Lock for lower cupboard



Display case

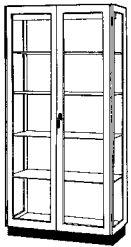

501.45. Can be supplied with glazed back.

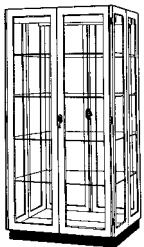

503.90

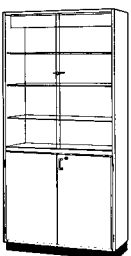

510.45.

Display case

Shell and doors of 19 mm chipboard. Shelves in block board with edging of solid wood. Glass shelves in 5 mm hardened glass. Glass doors fitted with hardened glass and with solid wood frame. Rebated doors with 15 mm solid wood edging. Espagnolette doors with handle incl. Abloy cylinder lock. On display case 510, the upper cupboard can be supplied with a glass display case lock and the lower cupboard with a cylinder lock. Self closing cast hinges with 180° opening angle. The cupboard can be supplied with spotlights. Fitted base, height 100 mm.

Depth 450 mm Width 1,000 mm, height 2,100 mm. (Incl base). Beech or birch.

- 501.45 Display case with glazed sides and front. 4 movable glass shelves. Can be supplied with glazed back.
- 503.90 Display case, double depth 450+450=900 mm with 8 movable glass shelves.
- 510.45 Display case with sliding glass doors, 3 movable glass shelves in upper section. 2 movable block board shelves, air tight doors in lower section. Can be supplied with glass display case lock.

Surcharge for glazed back for 501.45

Fitting with 3 spotlights

N7500 Glass display case lock

H Drawer units, cupboards, book shelves, wall shelves, pupil cupboards, teacher pigeon holes, library fittings, sheet steel cupboards



Textile handicrafts cupboard

Shell and doors of 19 mm chipboard. Shelves in block board with edging of solid wood. Rebated doors with 15 mm wood edging. Espagnolette with handle incl. Abloy cylinder lock on doors 1,200 mm and higher. Lower doors with wood handle. These doors can, on payment of a surcharge, be supplied with cylinder locks. Self closing cast hinges with 180° opening angle. Fitted base, height 100 mm.

Sewing equipment cupboard

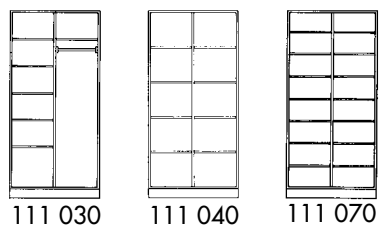

111 030 111 040 111 070

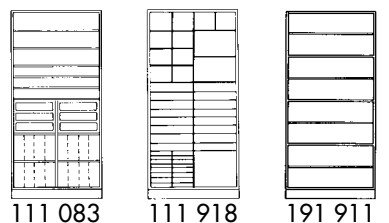

111 083 111 918 191 911

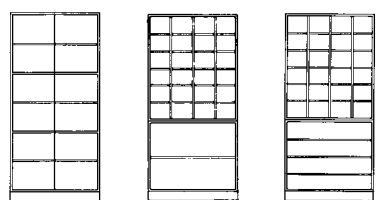

191 912 210 902+
411 100 210 902+
411 300



210 400+
411 006

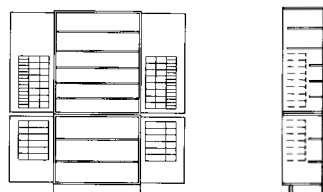

210 500+411 200
(810Y.30) (810Y.45)

Depth 300 mm Width 1,000 mm, height 2,100 mm. (Incl base). Beech or birch.

210 500+ Sewing equipment cupboard with 72 termotex drawers on the doors.
411 200.30 5 movable shelves in upper section. 2 movable shelves in lower section.
(810Y.30)

Depth 450 mm Width 1,000 mm, height 2,100 mm.(Incl base). Beech or birch.

111 030.45 Changing room cupboard with partition,
6 movable half shelves and clothes rail.

111 040.45 Materials cupboard with partition and
8 movable half shelves.

111 070.45 Materials cupboard with partition and
14 movable half shelves.

111 083.45 Materials cupboard with partition in upper section,
10 movable half shelves and 6 plastic drawers.

111 918.45 Sewing equipment cupboard with wool bays, form bays
and 16 plastic drawers

191 911.45 Pupil cupboard with 4 double doors incl lock.
3 fixed and 4 movable shelves.

191 912.45 Pupil cupboard with partition, 3 double doors incl lock.
2 fixed shelves and 6 movable half shelves.

210 902+ Materials cupboard with 24 wool bays in upper section
411 100.45 1 movable shelf in lower section.

210 902+ Materials cupboard with 24 wool bays in upper section
411 300.45 3 movable shelves in lower section.

210 400+ Materials cupboard with 4 movable shelves in upper section
411 006.45 and 12 plastic drawers in lower section .

210 500+ Sewing equipment cupboard with 72 termotex drawers on the doors.
411 200.45 5 movable shelves in upper section. 2 movable shelves in lower section.
(810Y.45)

FU lock Lock for lower cupboard



0516-L

Wood and metal handicrafts cupboard

Shell and doors of 19 mm chipboard. Shelves in block board with edging of solid wood. Rebated doors with 15 mm wood edging. Espagnolette with handle incl. Abloy cylinder lock on doors 1,200 mm and higher. Lower cupboard doors with wood handle. These doors can, on payment of a surcharge, be supplied with cylinder locks. Self closing cast hinges with 180° opening angle. Fitted base, height 100 mm.

Depth 450 mm, width 1,000 mm, height 2,100 mm. (Incl base). Beech or birch.

Tool cupboard

0516-L Tools cupboard with fittings for woodworking tools. 3 double doors with lock. Excluding tools.

0517-L Tools cupboard with fittings for metalwork tools. 3 double doors with lock. Excluding tools.

6771-L Tools cupboard with 2 pairs of doors, 1 movable shelf and tool panels in upper section. 2 movable shelves and 8 plastic drawers in lower section.

6772-L Tools cupboard with 1 fixed shelf. Tools panel in upper section: 2 movable shelves in lower section.

Wood and metal handicrafts cupboard. Beech or birch.

6759-L 1,000 x 100 h 2,100 mm. Pole Materials cupboard with 8 long and narrow bays. Open at the top for long material, without doors.

6758-L 1,000 x 100 h 2,100 mm. Pole Materials cupboard with 8 long and narrow bays. Open upwards for long materials, with doors.

1253-L 510 x 485 h 850 mm. Lathe cupboard on wheels, fittings for lathe tools. Raisable lid and door with cylinder lock.

1250-L 600 x 120 h 770 mm, Screw/nail cupboard, 5 movable shelves which can be assembled level or inclined.

1395-L 1000 x 450 h 750 mm. Screw clamp bench with folding table top of high pressure laminate. Recess for screw clamps. Cupboard doors are designed to support hinged table top. 1 movable shelf. Measurements, hinged table top = 1,000 x 850 mm
Measurements, folded table top = 1,000 x 470 mm



0517-L



6771-L



6772-L



6758-L and
6759-L



1253-L



1250-L



1395-L
(Screw clamp not included.)

More tools cupboards on the next page >>>

H Drawer units, cupboards, book shelves, wall shelves, pupil cupboards, teacher pigeon holes, library fittings, sheet steel cupboards



111 030



111 040



111 054



111 070



111 083



191 911



191 912



210 400+

411 006

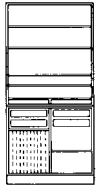

210 400+

411 012



111 905

Depth 450 mm Width 1,000 mm, height 2,100 mm. (Incl base). Beech or birch.

111 030.45	Changing room cupboard with partition, 6 movable half shelves and clothes rail.
111 040.45	Materials cupboard with partition and 8 movable half shelves.
111 054.45	Tools cupboard with partition, 10 half shelves and 8 plastic drawers.
111,070.45	Materials cupboard with partition and 14 movable half shelves.
111 083.45	Materials cupboard with partition in upper section, 10 movable half shelves and 6 plastic drawers.
191 911.45	Pupil cupboard with 4 double doors incl lock. 3 fixed and 4 movable shelves.
191 912.45	Materials cupboard with partition. 3 double doors including lock. 2 fixed shelves and 6 movable half shelves.
210 400+ 411 006.45	Materials cupboard with 4 movable shelves in upper section and 12 plastic drawers in lower section.
210 400+ 411 012.45	Drawing cupboard with 4 movable shelves in upper section. Partition, 1 half shelf, 4 plastic drawers in lower section. (Excluding drawing boards and edging)
111 905.45	Tools cupboard with 5 movable shelves 3 are inclined.
FU lock	Lock for lower cupboard

Custom width materials cupboard

80

Custom width range 800 mm, which can be supplied within six weeks from ordering.

Shell and doors of 19 mm chipboard. Shelves in block board with edging of solid wood.

The glazed the doors are fitted with hardened glass and have solid wood frames.

Rebated doors with 15 mm wood edging. Espagnolette with handle incl Abloy cylinder lock on doors 1200 mm and higher. Lower doors with wood handle. These doors can, on payment of a surcharge, be supplied with cylinder lock. Self closing cast hinges with 180° opening angle. Fitted base, height 100 mm.

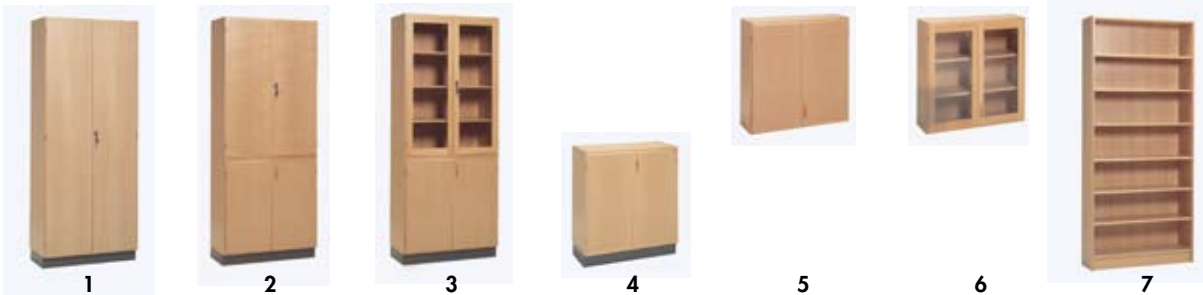

1	Depth 450 mm 111 400.45/80 111 500.45/80 111 600.45/80 111 700.45/80	Width 800 mm, height 2,100 mm (incl base). Beech or birch. Materials cupboard with 1 fixed shelf. 3 movable shelves. Materials cupboard with 1 fixed shelf. 4 movable shelves. Materials cupboard with 1 fixed shelf. 5 movable shelves. Materials cupboard with 1 fixed shelf. 6 movable shelves.
2	Depth 450 mm 210 200+ 411 100.45/80 210 300+ 411 200.45/80	Width 800 mm, height 2,100 mm (incl base) Materials cupboard with 1 fixed shelf. 2 movable shelves in upper section. 1 movable shelf in lower section. Materials cupboard with 1 fixed shelf. 3 movable shelves in upper section. 2 movable shelves in lower section.
3	220 300+ 411 200.45/80 220 400+ 411 200.45/80 220 300+ 421 200.45/80	Materials cupboard with 1 fixed shelf. 3 movable shelves and glazed doors in upper section. 2 movable shelves and air tight doors in lower section. Materials cupboard with 1 fixed shelf. 4 movable shelves and glazed doors in upper section. 2 movable shelves and air tight doors in lower section. Materials cupboard with 1 fixed shelf. 4 movable shelves and glazed doors in upper section. 2 movable shelves and glazed doors in lower section.
4	Depth 450 mm 411 200.45/80 Depth 300 mm 411 200.30/80	Width 800 mm, height 900 mm (incl base) Bench cupboard 2 shelf levels. Width 800 mm, height 900 mm (incl base) Bench cupboard with two shelves.
5	Depth 300 mm 510 200.30/80	Width 800 mm, height 800 mm Wall cupboard with joist on top edge for mounting on wall. Two shelves.
6	520 200.30/80	Wall cupboard with glazed doors. Joist on top edge for wall mounting. Two shelves.
7	Depth 300 mm 300 300+501 200.30/80 Depth 450 mm 200 300+401 200.45/80	Width 800 mm, height 2,100 mm (incl base) Bookshelf with 1 fixed and 5 movable shelves. Width 800 mm, height 2,100 mm (incl base) Bookshelf with 1 fixed and 5 movable shelves.

H Drawer units, cupboards, book shelves, wall shelves, pupil cupboards, teacher pigeon holes, library fittings, sheet steel cupboards



38-20-3

EKS 006 full length cupboard, h=1,500 mm (incl 150 mm base),
Fittings: three book/file bays and two clothes hooks. Flat roof.
Reinforced steel door. Cylinder lock in pass key system.

1 cupboard wide 2 cupboard wide 3 cupboard wide

38-20 b=300, d=500 mm
 surcharge for steel/laminate door



43-41-3

SKOL-FLEX full length cupboard, height 1,900 mm (incl 150 mm base),
Fittings: four book/file bays and two clothes hooks. Flat roof.
Reinforced steel door. Cylinder lock in pass key system.

1 cupboard wide 2 cupboard wide 3 cupboard wide

43-41 b=300, d=400 mm
 43-51 b=300, d=550 mm
 surcharge for steel/laminate door
 44-41 b=400, d=400 mm
 44-51 b=400, d=550 mm
 surcharge for steel/laminate door
 latch for padlock – per door



43-42-2

SKOL-FLEX half length cupboard, height 1,900 mm (incl 150 mm base),
Fittings: two book/file bays and two clothes hooks. Flat roof.
Reinforced steel door. Cylinder lock in pass key system.

1 cupboard wide 2 cupboard wide 3 cupboard wide

43-42 b=300, d=400 mm
 43-52 b=300, d=550 mm
 surcharge for steel/laminate door
 44-42 b=400, d=400 mm
 44-52 b=400, d=550 mm
 surcharge for steel/laminate door
 latch for padlock – per door



44-43

SKOL-FLEX one third length cupboard, height 1,900 mm (incl 150 mm base),
Fittings: shelf.
Flat roof. Reinforced steel door. Cylinder lock in pass key system.

1 cupboard wide 2 cupboard wide 3 cupboard wide

43-43 b=300, d=400 mm
 43-53 b=300, d=550 mm
 surcharge for steel/laminate door
 44-43 b=400, d=400 mm
 44-53 b=400, d=550 mm
 surcharge for steel/laminate door
 latch for padlock – per door



44-54

SKOL-FLEX quarter length cupboard, height 1,900 mm (incl 150 mm base), Flat roof. Reinforced steel door. Cylinder lock in pass key system.

- 43-44 b=300, d=400 mm
- 43-54 b=300, d=550 mm
surcharge for steel/laminate door
- 44-44 b=400, d=400 mm
- 44-54 b=400, d=550 mm
surcharge for steel/laminate door
latch for padlock – per door



34-42-2

SKOL-FLEX four section cupboard height 1,040 mm (incl 150 mm base), two cupboards high.

- 33-42 b=300, d=400 mm
- 33-52 b=300, d=550 mm
surcharge for steel/laminate door
- 34-42 b=400, d=400 mm
- 34-52 b=400, d=550 mm
surcharge for steel/laminate door
latch for padlock – per door
surcharge for MasterLock combination lock, per door



43-5Z-2

SKOL-FLEX Z-cupboard, height 1,900 mm (incl 150 mm base). Fittings: anchor hook and two book bays. Flat roof. Laminate door with varnished MDF-edge and piano hinges. Cylinder lock in pass key system.

- 43-5Z b=300, d=550 mm
- 44-5Z b=400, d=550 mm
surcharge for MasterLock combination lock, per door

H Drawer units, cupboards, book shelves, wall shelves, pupil cupboards, teacher pigeon holes, library fittings, sheet steel cupboards



Teacher pigeon holes

Shell and doors of 19 mm chipboard. Edging in solid wood. Frame in grey NCS 3502 B, height 200 mm. Lock with ASSA-cylinder in pass key system. Can also be supplied with padlock latch. Rebated doors with self closing cast hinges with 180° opening angle.

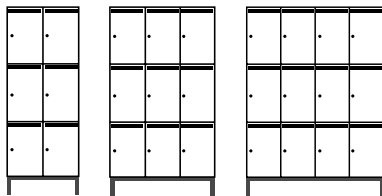

905-6 905-9 905-12

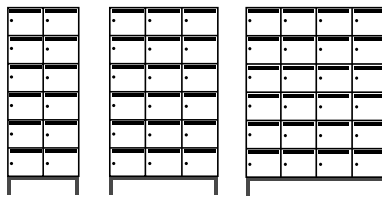

906-12 906-18 906-24

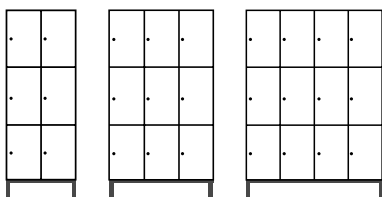

900-6 900-9 900-12

Depth 400mm Height 1,780 mm. (Incl frame). Beech or birch.

- 905-6 Cupboard width 660 mm. 6 pigeonholes with letterbox and shelf. Pigeonhole height 500 mm.
- 905-9 Cupboard width 980 mm. 9 pigeonholes with letterbox and shelf. Pigeonhole height 500 mm.
- 905-12 Cupboard width 1,300 mm. 12 pigeonholes with letterbox and shelf. Pigeonhole height 500 mm.
- 906-12 Cupboard width 660 mm. 12 pigeonholes with letterbox. Pigeonhole height 240 mm
- 906-18 Cupboard width 980 mm. 18 pigeonholes with letterbox. Pigeonhole height 240 mm
- 906-24 Cupboard width 1,300 mm. 24 pigeonholes with letterbox. Pigeonhole height 240 mm
- 900-6 Cupboard width 660 mm. 6 pigeonholes with shelf. Pigeonhole height 500 mm.
- 900-9 Cupboard width 980 mm. 9 pigeonholes with shelf. Pigeonhole height 500 mm.
- 900-12 Cupboard width 1,300 mm. 12 pigeonholes with shelf. Pigeonhole height 500 mm.
- Pkey Pass key



Wardrobe/storage cupboard

Shell and doors of 19 mm chipboard. Edging in solid wood. Lock with ASSA cylinder in pass key system. Can also be supplied with padlock latch. Rebated doors with 15 mm solid wood edging and self closing cast hinges with 180° opening angle. Fitted base, height 100 mm.

Depth 550 mm. Height 1,800 mm. Beech or birch.

- 180 130 Cupboard with 1 door, hat shelf, clothes rail. Width 300 mm.
- 180 140 Cupboard with 1 door, hat shelf, clothes rail. Width 400 mm.
- 180 230 Cupboard with 2 doors, file bay and clothes hook. Width 300 mm.
- 180 240 Cupboard with 2 doors, file bay and clothes hook. Width 400 mm.
- 180 330 Cupboard with 3 doors, file bay and clothes hook. Width 300 mm.
- 180 340 Cupboard with 3 doors, file bay and clothes hook. Width 400 mm.

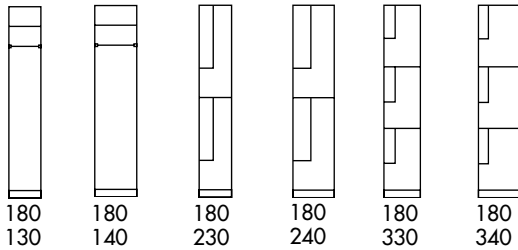

P-key Pass key



Wardrobe

Shell and doors of 19 mm chipboard. Edging of solid wood. Rebated doors with 15 mm wood edging and self closing cast hinges with 180° opening angle. All cupboards including lock cylinder. Deadbolt lock ASSA or espagnolette lock Abloy. Fitted base, height 100 mm.

Depth 600 mm. Height 2,100 mm. Beech or birch.

- 21/30 Wardrobe, width 300 mm, deadbolt lock
- 21/40 Wardrobe, width 400 mm, deadbolt lock
- 21/50 Wardrobe, width 500 mm, deadbolt lock
- 21/60 Wardrobe, width 600 mm, deadbolt lock
- 21/80 Wardrobe, width 800 mm, espagnolette and handle. Double doors
- 21/100 Wardrobe, width 1,000 mm, espagnolette and handle. Double doors

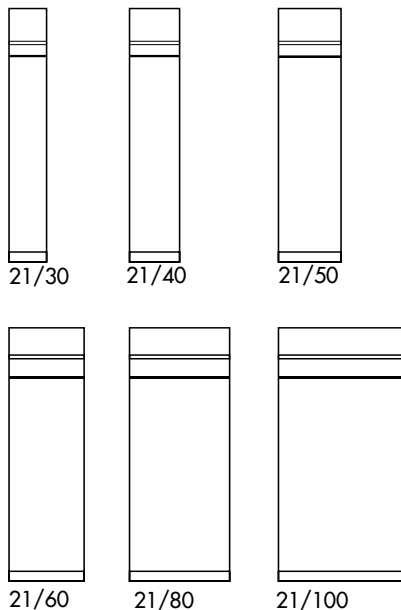

All cupboards with hat shelf and clothes rail.

H Drawer units, cupboards, book shelves, wall shelves, pupil cupboards, teacher pigeon holes, library fittings, sheet steel cupboards



Storage

Shell of 19 mm chipboard. Edging of solid wood. Drawers in plywood on expansion fitting. Supplied with 5 wheels of which 2 with brake, wheel height 85 mm. Back in veneered version. Can also be supplied with back in cork linoleum. (Space for two A4 sheets across width.)

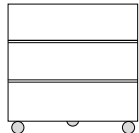

404 200

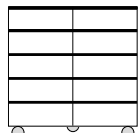

494 000



494 000

Storage, 1,000 x 450 h 900 mm.
10 drawers on expansion fitting.

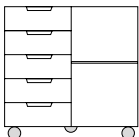

494 000/5

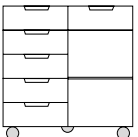

494 000/6



494 000/5

Storage, 1,000 x 450 h 900 mm, 5 drawers on expansion fitting, 1 half shelf.

494 000/6

Storage, 1,000 x 450 h 900 mm, 6 drawers on expansion fitting, 1 half shelf.

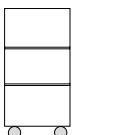

404 200/50

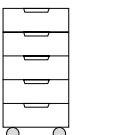

494 000/50

404 200/50

Storage 510 x 450 h 880 mm.
2 movable shelves

494 000/50

Storage 510 x 450 h 900 mm
5 drawers on expansion fitting

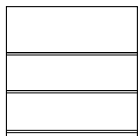

204 300

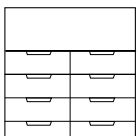

294 100



294 100

Storage, 1,000 x 450 h 1,280 mm.
3 movable shelves

Storage, 1,000 x 450 h 1,280 mm.
10 drawers on expansion fitting and file shelf.



294 110

Storage, 1,000 x 450 h 1,280 mm.
5 drawers on expansion fitting, 1 half shelf and file shelf.

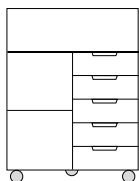

294 110

A404 F

Surcharge for back in cork linoleum for 1,000x900 mm.

A204 F

Surcharge for back in cork linoleum for 1,000x1,280 mm.



Storage

Shell of 19 mm chipboard. Edging of solid wood. Drawers in plywood which slide on wood rails. Supplied with 5 wheels of which 2 with brake.

Wheel height 85 mm. Back in veneered version.

Can also be supplied with back in cork linoleum.

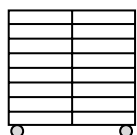

404 908

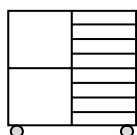

404 914

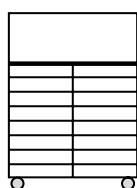

204 908

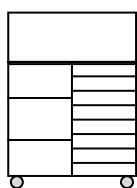

204 114

Beech or birch.

- | | |
|---------|---------------------------------------------------------------------------------------------------------------------|
| 404 908 | Storage, 1,000 x 450 h 880 mm.
16 drawers in plywood which slide on wood rails. |
| 404 914 | Storage, 1,000 x 450 h 880 mm, 8 drawers in plywood a which slide on wood rails. 1 half shelf. |
| 204 908 | Storage, 1,000 x 450 h 1,280 mm.
16 drawers in plywood which slide on wood rails, file shelf. |
| 204 114 | Storage, 1,000 x 450 h 1,280 mm.
8 drawers in plywood, which slide on wood rails,
2 half shelves, file shelf. |
| A404 F | Surcharge for back in cork linoleum
for 1,000x880 mm. |
| A204 F | Surcharge for back in cork linoleum
for 1,000x1,280 mm. |



124 005X

Vete

Design: Staffan Lauthers

Shell of 19 mm chipboard. Edging of solid wood. Drawers on expansion fitting. Supplied with 5 wheels of which 2 with brake, wheel height 70 mm or 120 mm.

Back in veneered version. Can also be supplied with back in cork linoleum or whiteboard. Front: White drawer front is standard (NCS 0502 Y). Light green (NCS S2040-G70Y) or light blue (NCS S2020- R70B) drawer front on payment of a surcharge.



124 006

Birch

- | | |
|----------|--------------------------------------------------------------------------------------------------------------------------------|
| 124 005X | Storage Vete, 10 drawer. 1,200 x 450 height 720 mm.
Drawer internal measurements: 540 x 400 x 110. Wheel height 70 mm. |
| 124 005 | Storage Vete, 10 drawer. 1,200 x 450 height 770 mm.
Drawer internal measurements: 540 x 400 x 110 mm. Wheel height 120 mm. |
| 124 006 | Storage Vete, 12 drawers. 1,200 x 450 height 900 mm.
Drawer internal measurements: 540 x 400 x 110 mm. Wheel height 120 mm. |
| 124 915 | Storage Vete, 6 drawers. 1,200 x 450 height 900 mm.
Drawer internal measurements: 540 x 400 x 110 mm. Wheel height 120 mm. |

Surcharge for back in cork linoleum designed for Vete

Surcharge for back in Whiteboard designed for Vete



124 915

H Drawer units, cupboards, book shelves, wall shelves, pupil cupboards, teacher pigeon holes, library fittings, sheet steel cupboards



Ida - mobile shelf

Manufactured in clear varnished and glazed birch veneer. The shelf folds out to double the width and contains shelves, drawers, clothes rail, knobs and can, on payment of a surcharge, be supplied with a removable mirror. This shelf is adapted for children in nursery schools, can be used for makeup and theatre dressing rooms, or for storage. The shelf can be used for screening.

125 013 Mobile shelf, folded b 1,000 mm x d 600 mm x h 1,200 mm



Emil - mobile shelf

Manufactured in clear varnished and glazed birch veneer. The shelf folds to double width and contains shelves and drawers. Areas of usage are storage and screening.

125 033 Mobile shelf, folded b 1,000 mm x d 600 mm x h 1,200 mm

Counter unit cupboard

Shell and doors of 19 mm chipboard. Shelves in block board. Edging in solid wood. Doors with wood handles which, on the payment of a surcharge, can be supplied with deadbolt locks. Espagnolette with handle incl. Abloy cylinder lock on doors 1200 mm. Rebated doors with 15 mm solid wood edging and self closing cast hinges with 180° opening angle. Fitted base, height 100 mm. Veneered top.



Beech or birch.

- 411 006.45 Materials cupboard 1,000 x 450 h 900 mm. 12 drawers in plastic.
- 411 011.45 Materials cupboard 1,000 x 450 h 900 mm. Partition, 2 plastic drawers, 2 half shelves.
- 411 013.45 Materials cupboard 1,000 x 450 h 900 mm. Partition, 6 plastic drawers, 2 half shelves.
- S** 411 200.45 Materials cupboard 1,000 x 450 h 900 mm, 2 shelves.
- 414 013.45 Materials cupboard 1,000 x 450 h 900 mm on wheels. High quality finish rear, 6 plastic drawers, 2 half shelves.
- S** 411 200.30 Materials cupboard 1,000 x 300 h 900 mm, 2 shelves.
- 491 901.30 Wall chart cupboard 1000 x 300 h 900 mm. Back for vertical wall charts.
- 711 004.45 Pupil cupboard 1,000 x 450 h 700 mm. 8 plastic drawers.
- 711 012.45 Materials cupboard 1,000 x 450 h 700 mm. Partition, 2 half shelves, 4 plastic drawers.
- 711 100.45 Materials cupboard, 1,000 x 450 h 700 mm, 1 shelf.
- 411 200.60 Materials cupboard 1,000x600 h 900 mm, 2 shelves.
- 211 300.30 Materials cupboard 1,000x300h1,300 mm, 3 shelves.
- 211 300.45 Materials cupboard 1,000x450h1,300 mm, 3 shelves.
- 211 300.60 Materials cupboard 1,000x600h1,300 mm, 3 shelves.
- FU lock Lock for counter unit cupboard

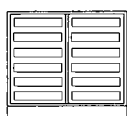

411 006

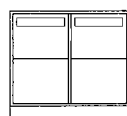

411 011

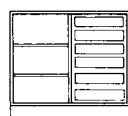

411 013

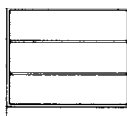

411 200



414 013

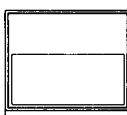

491 901

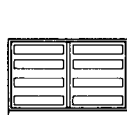

711 004

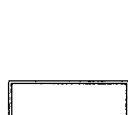

211 300

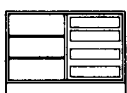

711 012

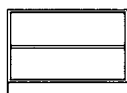

711 100

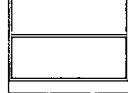

211 300



Counter unit cupboard for counter unit top



841 100K



851 100K



711 100K



941 200K



951 000K



411 200K



854 000

Rolling drawer unit with veneered back and top.



844 100

Shell and doors of 19 mm chipboard. Shelves in block board with edging in solid wood. Drawer fronts in veneered MDF board. Doors with wood handle which, on the payment of a surcharge, can be supplied with deadbolt locks. Door for 500 mm wide drawer unit is right hung. Rebated doors with 15 mm solid wood edging and self closing cast hinges with 180° opening angle. Fitted base, height 100 mm. *Right hung doors on cupboard drawer unit b=500 mm is standard.*

Beech or birch

841 100.45K	Cupboard drawer unit 500 x 450 h 700 mm, 1 movable half shelf.
851 000.45K	Drawer unit 500 x 450 h 700 mm, 4 drawers.
711 100.45K	Cupboard 1,000 x 450 h 700 mm, 1 movable shelf level.
841 100.58K	Cupboard drawer unit 500 x 580 h 700 mm, 1 movable half shelf.
851 000.58K	Drawer unit 500 x 580 h 700 mm, 4 drawers.
711 100.58K	Cupboard 1,000 x 580 h 700 mm, 1 movable shelf level.
941 200.45K	Cupboard drawer unit 500 x 450 h 880 mm, 2 movable half shelves.
951 000.45K	Drawer unit 500 x 450 h 880 mm, 6 drawers.
411 200.45K	Cupboard 1,000 x 450 h 880 mm, 2 movable shelves.
941 200.58K	Cupboard drawer unit 500 x 580 h 880 mm, 2 movable half shelves.
951 000.58K	Drawer unit 500 x 580 h 880 mm, 6 drawers.
411 200.58K	Cupboard 1,000 x 580 h 880 mm, 2 movable shelves.
854 000.45	Rolling drawer unit, 4 drawers. 500 x 450 h 620 mm.
844 100.45	Rolling drawer unit, door and 1 movable shelf. 500x450 h 620 mm.
FU lock	Lock for counter unit cupboard

H Drawer units, cupboards, book shelves, wall shelves, pupil cupboards, teacher pigeon holes, library fittings, sheet steel cupboards

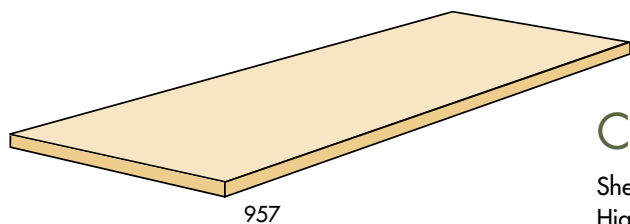

Counter unit top and fittings

Shell in overlaid counter unit top is 19 mm chipboard. Edging in solid wood. High pressure laminate 0.8 mm. Standard white K1040, beech K7016 or birch K7024. Laminated table top is solid wood, 30 mm thick. Can be supplied with the back edging in solid wood, 9 x 50 mm. Support leg in 30x30 mm steel tubing. Adjustable floor protectors, surface treatment in grey epoxy lacquer (NCS 3502 B).

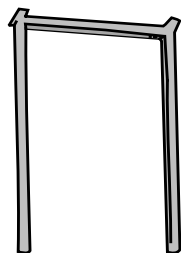

Double support leg

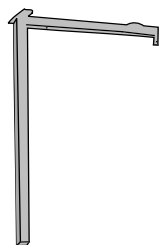

Single support leg

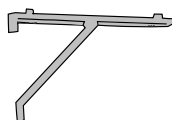

Wall bracket

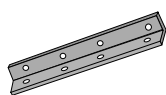

Wall bracket

957.47L	Counter top with surface in high pressure laminate, depth 470 mm. Thickness 20 mm.
957.60L	Counter top with surface in high pressure laminate, depth 600 mm. Thickness 20 mm.
957.47 Lin	Counter top with surface in beige linoleum, depth 470 mm. Thickness 20 mm.
957.60 Lin	Counter top with surface in beige linoleum, depth 600 mm. Thickness 20 mm.
957.47F	Counter top with surface in veneer, depth 470 mm. Thickness 20 mm.
957.60F	Counter top with surface in veneer, depth 600 mm. Thickness 20 mm.
957.47 Stav	Counter top in solid wood, depth 470 mm. Thickness 30 mm.
957.60 Stav	Counter top in solid wood, depth 600 mm. Thickness 30 mm.
FBL	Raised rear edging 9 x 50 mm
87/70.45	Double support leg, height 700 mm, depth 450 mm
87/88.45	Double support leg, height 880 mm, depth 450 mm
87/70.58	Double support leg, height 700 mm, depth 580 mm
87/88.58	Double support leg, height 880 mm, depth 580 mm
86/70.45	Single support leg, height 700 mm, depth 450 mm
86/88.45	Single support leg, height 880 mm, depth 450 mm
86/70.58	Single support leg, height 700 mm, depth 580 mm
86/88.58	Single support leg, height 880 mm, depth 580 mm
88A	Wall bracket, depth 450 mm
88B	Wall bracket, depth 550 mm
88C	Wall bracket, length 400 mm



Sink unit cupboard

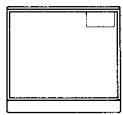

411 000

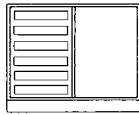

411 003



711 000

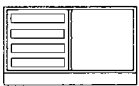

711 002

Sink unit cupboard

Shell and doors of 19 mm chipboard. Shelves in block board. Doors with wood handle which, on the payment of a surcharge, can be supplied with deadbolt locks. Rebated doors with 15 mm solid wood edging and self closing cast hinges with 180° opening angle. Bottom in the cupboard with 'opening' at the back for cable lead throughs. Fitted base, height 100 mm.

Beech or birch

411 000.45	Sink unit cupboard 1,000 x 450 h 880 mm.
411 000.58	Sink unit cupboard 1,000 x 580 h 880 mm.
411 003.45	Sink unit cupboard 1,000 x 450 h 880 mm. 6 internal drawers.
711 000.45	Sink unit cupboard.1,000 x 450 h 700 mm.
711 000.58	Sink unit cupboard.1,000 x 580 h 700 mm.
711 002.45	Sink unit cupboard 1,000 x 450 h 700 mm. 4 internal drawers.

Sink fitting

Sink fittings in stainless steel. Right and left positioned drawers. Turned down edges on all sides. Built in sink with 20 mm rim. In addition to the below specified fittings, we supply fittings to customer requirements.

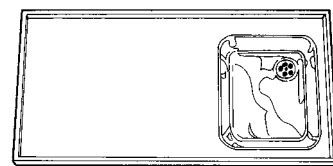

301 V or H
302 L or R

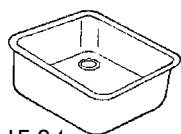

LE 34

Stainless

301V or H	Sink fitting 1,000x470 mm with sink LE34 (340x400 mm), incl. water lock.
302V or H	Sink fitting 1,000x600 mm with LE34 (340x400 mm), incl. water lock.
F10 R	Sink fitting with outlet funnel 290x400 mm, depth 160 mm, water lock.
LE 34	Built in sink, 340x400 mm, depth 160 mm, incl. water lock.
G 10	Sink unit fittings 1,000x600 mm, 2 drawer, depth 160 mm Left or right version incl. water lock.

H Drawer units, cupboards, book shelves, wall shelves, pupil cupboards, teacher pigeon holes, library fittings, sheet steel cupboards



Wall cupboard

Shell and doors of 19 mm chipboard. Shelves in block board with edging of solid wood. Glass doors fitted with hardened glass and with solid wood frame. Rebated doors with 15 mm solid wood rails and wood handle. These doors can, on payment of a surcharge, be supplied with cylinder locks. Self closing cast hinges with 180° opening angle. Joist at top edge of the cupboard for mounting on wall.

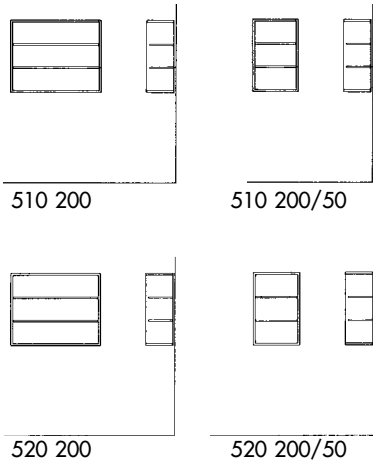

80

Beech or birch

510 200.30

Wall cupboard 1,000 x 300 h 800 mm, air tight doors. 2 movable shelves.

510 200.30/50

Wall cupboard 500 x 300 h 800 mm, airtight doors. 2 movable half shelves.

80

520 200.30

Wall cupboard 1,000 x 300 h 800 mm, glazed doors, 2 movable shelves.

520 200.30/50

Wall cupboard 500 x 300 h 800, glazed doors. 2 movable half shelves.

Lock F

Lock for wall cupboard



Drawing cupboard

Shell of 19 mm, beech or birch veneered chipboard. The drawers are manufactured of solid pine. Fronts in veneered version have recessed handle. Slide rails in solid red beech. Manufactured in several sizes in addition to those specified below. There are partitions for drawers to divide into smaller compartments.

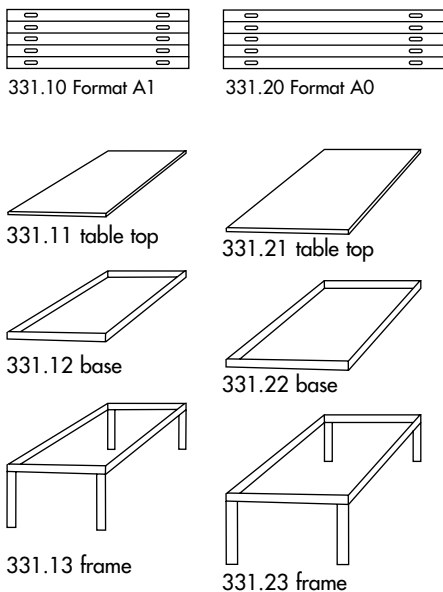

331.10

Drawing cabinet 991 x 680 x 344 mm, 5 drawers. A1.

331.11 table top

Table top in veneer 1,000x690 mm.

331.12 base

Base, height 100 mm. Black.

331.13 frame

Steel tubing frame, white epoxy lacquer NSC 0502 Y. Height 400 mm.

331.20

Drawing cabinet 1,345 x 950 x 344 mm, 5 drawers. A0.

331.21 table top

Table top in veneer 1,355x960 mm.

331.22 base

Base, height 100 mm. Black.

331.23 frame

Steel tubing frame, white epoxy lacquer NCS 0502 Y. Height 400 mm.

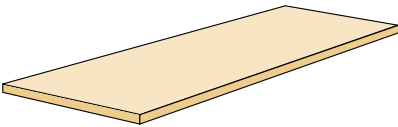

31, 41, 51, 32, 42, 52

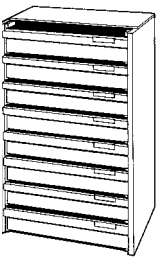

Li 2, Li 4, Li 6, Li 8

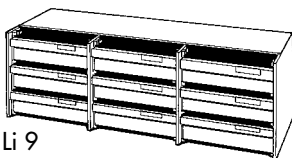

Li 9

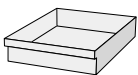

6548

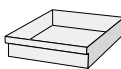

6549

Cupboard inserts and shelves in base cupboard

Drawer inserts with plastic drawers and slider strips in solid beech.

Red beech or birch

31.25	Shelf 960 x 250 mm for cupboard d=300 mm
31.30	Shelf 960 x 300 mm for bookshelf d=300 mm
41.40	Shelf 960 x 400 mm for cupboard d=450 mm
41.45	Shelf 960 x 450 mm for bookshelf d=450 mm
51.55	Shelf 960 x 550 mm for cupboard d=600 mm
51.60	Shelf 960 x 600 mm for bookshelf d=600 mm
32/46	Shelf 460 x 250 mm for cupboard b=500 d=300 mm
32/47	Shelf 470 x 250 mm for cupboard with partition d=300 mm
42/46	Shelf 460 x 400 mm for cupboard b= 500 d=450 mm
42/47	Shelf 470 x 400 mm for cupboard with partition d=450 mm
52/46	Shelf 460 x 550 mm for cupboard b=500 d=600 mm
52/47	Shelf 470 x 550 mm for cupboard with partition d=600 mm

Li 2	Drawer insert, 2 drawer, 480 x 400 x 230 mm
Li 4	Drawer insert, 4 drawer, 480 x 400 x 410 mm
Li 6	Drawer insert, 6 drawer, 480 x 400 x 560 mm
Li 8	Drawer insert, 8 drawer, 480 x 400 x 760 mm
Li 9	Drawer insert, 9 drawer, 960 x 400 x 320 mm

6548	Plastic drawer, 435x400x85 (1/2-drawer)
6549	Plastic drawer, 295x400x85 (1/3-drawer)

H Drawer units, cupboards, book shelves, wall shelves, pupil cupboards, teacher pigeon holes, library fittings, sheet steel cupboards

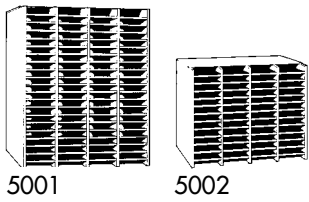

5001

5002

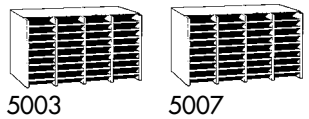

5003

5007

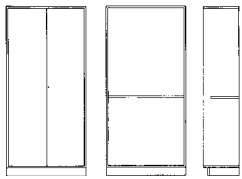

G 111 100

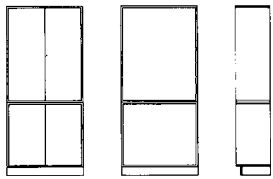

G 210 000+411 000

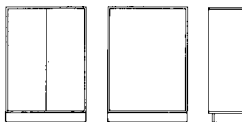

G 211 000



G 411 000

Cupboard inserts

Form bay in board with wood rails or plastic.
In insert 5007, the form bay is manufactured in plastic and has raised side edges.

- 5001 Form insert with 80 extractable A4 bays in board.
960 x 340 x 1160 mm
- 5002 Form insert with 48 extractable A4 bays in board.
960 x 340 x 780 mm
- 5003 Form insert with 32 extractable A4 bays in board.
960 x 340 x 400 mm
- 5007 Form insert with 32 extractable plastic A4 bays.
960 x 340 x 400 mm

Base cupboard

Shell and doors of 19 mm chipboard. Rebated doors with 15 mm wood edging. Espagnolette with handle incl. Abloy cylinder lock on doors. 1,200 mm and higher. Lower doors with wood handle. These doors can, on payment of a surcharge, be supplied with cylinder locks. Self closing cast hinges with 180° opening angle. Fitted base, height 100 mm.

Beech or birch



- G 111 100.45 Base cupboard 1,000x450x2,100 mm. 1 fixed shelf.
- G 210 000+411 000.45 Base cupboard, split front 1,000x450x2,100 mm. 1 fixed shelf.
- G 211 000.45 Base cupboard, 1,000x450x1,300 mm.
- G 411 000.45 Base cupboard, 1,000x450x900 mm.
- FU lock Lock for low cupboard/lower cupboard

Accessories and replacement parts

	Lock F 10 10H	Deadbolt lock Abloy Key Abloy Pass key Abloy		391350 Padlock latch ASSA
	10450 20 P-key	Deadbolt lock ASSA Key ASSA Pass key ASSA		593 Lock casing ASSA Drilling
	3426	Press button lock Abloy		414 Maple hinge
	423	Espagnolette handle	 96 mm cc	1023-96 rb Beech handle 1023-96 bj Birch handle
	Lock C	Alas lock in plastic designed for simultaneous locking of the upper and lower section.		1702/400 Expansion fitting /pair
	835	Fix handle for ASSA-cylinder		41B Shelf supports, 30 cm 31B Shelf supports, 20 cm
	98669	Padlock latch incl. joist		1020 Clothes hook, large 1021 Clothes hook, small
				13133 Wheel 13231 Wheel with brake
				589 Lock housing 423 including closing device and fitting (Handle and lock cylinder not included)

H Drawer units, cupboards, book shelves, wall shelves, pupil cupboards, teacher pigeon holes, library fittings, sheet steel cupboards

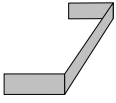
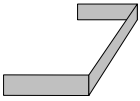
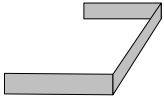
Accessories and replacement parts

	1000.30	Base for 300 mm depth.		1200G-rb	1,200 mm, glazed top cupboard doors. Red beech/pair
	1000.45	Base for 450 mm depth.		1200G-bj	1,200 mm, glazed top cupboard doors. Birch/pair
	1000.60	Base for 600 mm depth.		780H -rb	800 mm, red beech veneered lower cupboard doors/pair
	0071	Shelf for teacher pigeonhole.		780H -bj	800 mm, birch veneered lower cupboard doors/pair
		Colour: All bases grey NCS 7500. Height 100 mm.			

Separate doors for cupboard excluding lock, hinges and espagnolette

	2000H-rb	2,000 mm, red beech veneered tall cupboard doors/pair		780G-rb	800 mm, glazed lower cupboard doors. Red beech/pair
	2000H-bj	2,000 mm, birch veneered tall cupboard doors/pair		780G-bj	800 mm, glazed lower cupboard doors. Birch/pair
	2000G-rb	2,000 mm, glazed tall cupboard doors. Red beech/pair		500H-rb	Teacher pigeonhole door 905 in red beech veneer/piece
	2000G-bj	2,000 mm, glazed tall cupboard doors. Birch/pair		500H-bj	Teacher pigeonhole door 905 in birch veneer/piece
	1200H-rb	1,200 mm, red beech veneered top cupboard doors /pair			
	1200H-bj	1,200 mm, birch veneered top cupboard doors/pair			



Carpenter - mobile studio table



The table has, as standard, a varnished solid oak table top, as an option is available a high pressure laminated table top. Under this are 6 wood drawers and 6 open bays on each long side, for storage of work, tools and materials. Shell and drawers are of clear varnished birch veneer. Height 900 mm. Table top overhang makes it possible to sit on high chairs around the table. A flexible work space suitable for many environments.

360-56	table top 2,000 x 1,200 mm of solid oak
360-55	table top 2,000 x 1,200 mm with oak laminate K 6149



200 300+
401 200

201 300

401 200

854 600

Book shelves

Shell of 19 mm chipboard. Movable shelves in block board. Back in board, beech or birch pattern. The sides go down to the floor. Notch in back edge for floor base. Front section of base in veneer.

Depth 300 mm. Beech or birch.

80 S	200 300+	Bookshelf 1,000 x 300 h 2,100 mm
	401 200.30	1 fixed shelf and 5 movable shelves.
S	201 300.30	Bookshelf 1,000 x 300 h 1,300 mm. 3 movable shelves.
	401 200.30	Bookshelf 1,000 x 300 h 900 mm. 2 movable shelves.
	500 200.30	Wall bookshelf 1,000x300 h 800 mm

Depth 450 mm. Beech or birch.

S	200 300+	Bookshelf 1,000 x 450 h 2,100 mm
	401 200.45	1 fixed shelf and 5 movable shelves.
S	201 300.45	Bookshelf 1,000 x 450 h 1,300 mm. 3 movable shelves.
	401 200.45	Bookshelf 1,000 x 450 h 900 mm 2 movable shelves.
	204 300.45	Single bookshelf on wheels 1,000 x 450 h 1,280 mm 3 movable shelves veneered back.
	404 200.45	Single bookshelf on wheels 1,000 x 450 h 880 mm 2 movable shelves veneered back.

Depth 600 mm. Beech or birch.

	854 600.60	Double bookshelf on wheels 1,000 x 600 h 1,280 mm 6 movable shelves, veneered back.
	864 400.60	Double bookshelf on wheels 1,000 x 600 h 880 mm 4 movable shelves, veneered back.

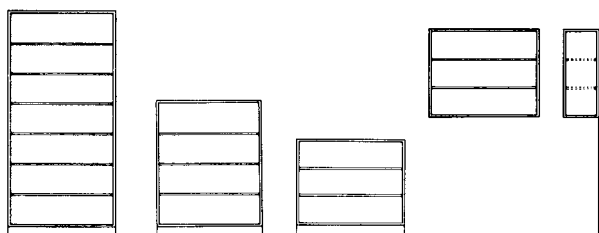

200 300+
401 200

201 300

401 200

Wall bookshelves
500 200.30

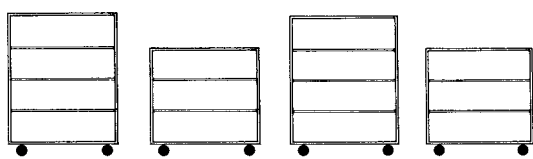

854 600.60

864 400.60

204 300.45

404 200.45

H Drawer units, cupboards, book shelves, wall shelves, pupil cupboards, teacher pigeon holes, library fittings, sheet steel cupboards



Shelf

Shelves with shell 19 mm block board. Shelves in high pressure laminate (HTL) with overlapping laminated edging.

		Beech(RB)	Birch(BJ)	HTL
Shelves with edging on 3 sides				
61.09030	Veneered block board, 90x30 cm			
61.09040	Veneered block board, 90x40 cm			
61.10030	Veneered block board, 100x30 cm			
61.10040	Veneered block board, 100x40 cm			
61.xxx30	Veneered block board, w 30 cm/m			
61.xxx40	Veneered block board, w 40 cm/m			
61.xxx50	Veneered block board, w 50 cm/m			
62.xxx30	Magazine shelf w 30 cm/m			
62.xxx35	Magazine shelf w 35 cm/m			
Shelves with edging on 1 side				
60.09030	Veneered block board 90x30 cm			
60.09040	Veneered block board 90x40 cm			
60.10030	Veneered block board 100x30 cm			
60.10040	Veneered block board 100x40 cm			
60.xxx30	Veneered block board w 30 cm/m			
60.xxx40	Veneered block board w 40 cm/m			
60.xxx50	Veneered block board w 50 cm/m			
Shelves of melamine overlaid chipboard				
Other sizes can be supplied.				
90309	White 90x30 cm			
90409	White 90x40 cm			
90316	White 160x30			
91309	Birch 90x30 cm			
91409	Birch 90x40 cm			
91316	Birch 160x30 cm			
92309	Beech 90x30 cm			
92409	Beech 90x40 cm			
92316	Beech 160x30 cm			
70085	Magazine list 85 cm, sheet steel			

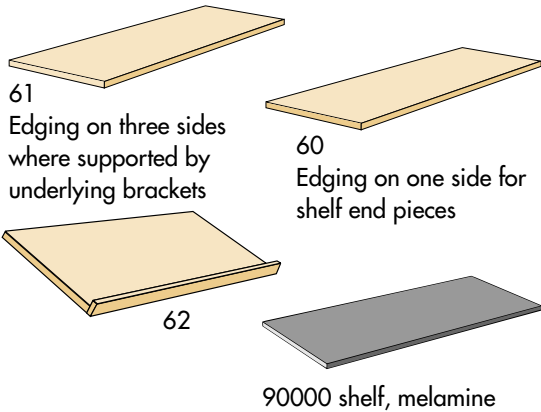

Shelf system

11007	Wall rail 68.3 cm
11008	Wall rail 78.1 cm
11009	Wall rail 91.1 cm
11010	Wall rail 100.9 cm
11012	Wall rail 120.4 cm
11014	Wall rail 140.0 cm
11016	Wall rail 159.5 cm
11018	Wall rail 179.0 cm
11020	Wall rail 198.6 cm
11022	Wall rail 218.1 cm
12000	Reinforced rail - ask for offer.
10012	Support rail 122 cm
10016	Support rail 167 cm
10019	Support rail 190 cm
10028	Support rail 280 cm
10300	Cover strip per m
10500	End stop for wheels

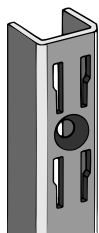

Wall rail 11000

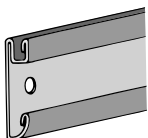

Support rail

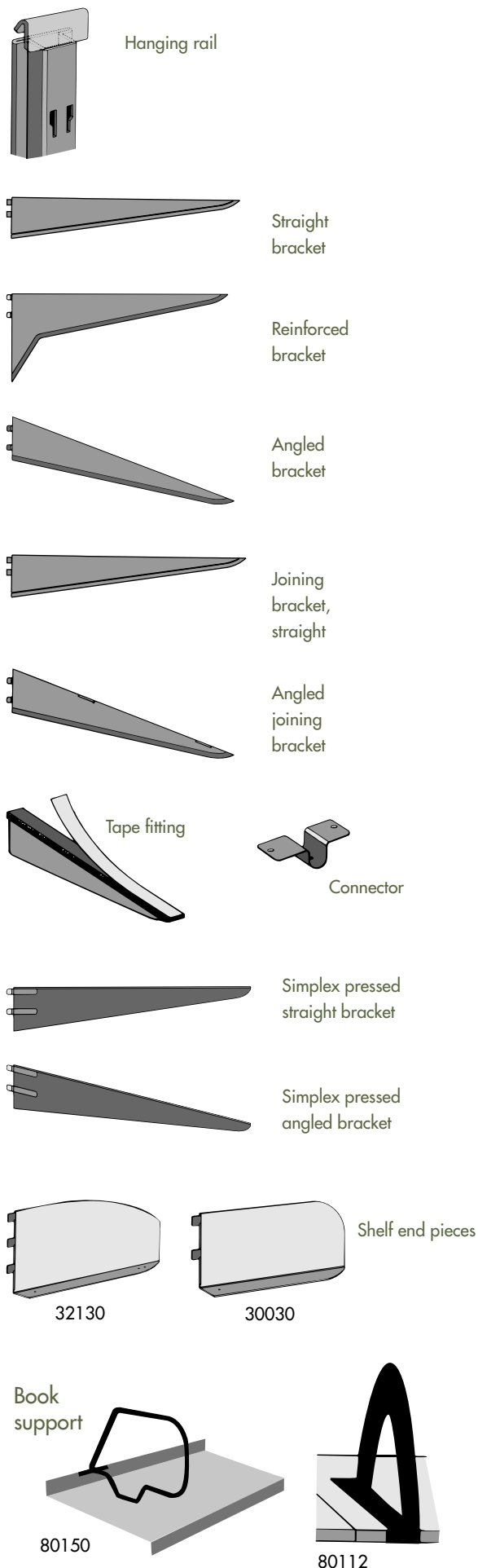

10110	Hanging rail 101 cm
10113	Hanging rail 124 cm
10115	Hanging rail 150 cm
10120	Hanging rail 195 cm
20027	Bracket straight 27 cm
20037	Bracket straight 37 cm
20047	Bracket straight 47 cm
20127	Straight reinforced bracket 27 cm
20137	Straight reinforced bracket 37 cm
20147	Straight reinforced bracket 47 cm
20157	Straight reinforced bracket 57 cm
20527	Angled bracket 27 cm
20537	Angled bracket 37 cm
25027	Straight joining bracket 27 cm
25037	Straight joining bracket 37 cm
25047	Straight joining bracket 47 cm
25527	Angled joining bracket 27 cm
25537	Angled joining bracket 37 cm
80330	Loose joint fitting incl screws
25700	Tape fitting surcharge
35027	Simplex pressed straight bracket 27 cm pair
35037	Simplex pressed straight bracket 37 cm pair
35527	Simplex pressed angled bracket 27 cm pair
35537	Simplex pressed angled bracket 37 cm pair
30000	Shelf end piece height 13.5 cm
30030	Shelf end piece 30 cm/pair
30040	Shelf end piece 40 cm/pair
30130	Rounded shelf end piece 30 cm/pair
30140	Rounded shelf end piece 40 cm/pair
32000	Shelf end piece height 19.5 cm
32030	Shelf end piece 30 cm/pair
32040	Shelf end piece 40 cm/pair
32130	Rounded shelf end piece 30 cm/pair
32140	Rounded shelf end piece 40 cm/pair
72020	Rear edging for movable book support
80150	Book support for rear edging, 24 cm
80112	Clamp support 20 cm

H Drawer units, cupboards, book shelves, wall shelves, pupil cupboards, teacher pigeon holes, library fittings, sheet steel cupboards



Softline - Slimline

is a flexible shelf system with many design and function options. The system is available in six heights, two width modules and five end piece depths. The shelves are subdivided into start and expansion sections. The standard version has veneered end pieces in natural beech, with metal shelves and metal frames in off-white. Softline has a rounded edge and Slimline a straight front edge.

Birch and other colours available as option.

HE5 Single sided, 4 shelves+top, height 1,527 mm end piece depth 334, shelf depth 273 mm:

- 735501 Section width 911 mm, start section
- 735502 Section width 889 mm, add on section
- 735601 Section width 761 mm, start section
- 735602 Section width 739 mm, add on section

Single sided, 5 shelves+top, height 1,815 mm:

- 735503 Section width 911 mm, start section
- 735504 Section width 889 mm, add on section
- 735603 Section width 761 mm, start section
- 735604 Section width 739 mm, add on section

Single sided, 6 shelves+top, height 2,103 mm:

- 735507 Section width 911 mm, start section
- 735508 Section width 889 mm, add on section
- 735607 Section width 761 mm, start section
- 735608 Section width 739 mm, add on section

Double sided, 4 shelves+top, height 1,527 mm end piece depth 514, shelf depth 221 mm

- 735509 Section width 911 mm, start section
- 735510 Section width 889 mm, add on section
- 735609 Section width 761 mm, start section
- 735610 Section width 739 mm, add on section

Double sided, 5 shelves+top, height 1,815 mm:

- 735511 Section width 911 mm, start section
- 735512 Section width 889 mm, add on section
- 735611 Section width 761 mm, start section
- 735612 Section width 739 mm, add on section

Double sided, 6 shelves+top, height 2,103 mm:

- 735513 Section width 911 mm, start section
- 735514 Section width 889 mm, add on section
- 735613 Section width 761 mm, start section
- 735614 Section width 739 mm, add on section

Double sided, 4 shelves+top, height 1,527 mm end piece depth 642, shelf depth 273 mm:

- 735515 Section width 911 mm, start section
- 735516 Section width 889 mm, add on section
- 735615 Section width 761 mm, start section
- 735616 Section width 739 mm, add on section

Double sided, 5 shelves+top, height 1,815 mm:

- 735517 Section width 911 mm, start section
- 735518 Section width 889 mm, add on section
- 735617 Section width 761 mm, start section
- 735618 Section width 739 mm, add on section

Double sided, 6 shelves+top, height 2,103 mm:

- 735521 Section width 911 mm, start section
- 735522 Section width 889 mm, add on section
- 735621 Section width 761 mm, start section
- 735622 Section width 739 mm, add on section

Book support, wheel frame

- 733040 Book support, hanging, Softline
- 734211 Wheel frame, double section 867x438 mm
- 734209 Wheel frame, double section 717x438 mm
- 734212 Wheel frame, double section 867x566 mm
- 734210 Wheel frame, double section 717x566 mm

Other sizes and versions can be supplied.



4213



4015



4051

Halland book trolley 52x48 h=109 cm, shelf depth 21 cm. Single sided book trolley with four inclined shelves of which two movable.

- 4213 red/beechn
- 4214 white/beechn
- 4215 silver/birch

Gotland book trolley 66.5x43 h=111 cm, shelf depth 18 cm. Double sided book trolley with eight inclined shelves of which six movable.

- 4015 red/beechn
- 4017 white/beechn

Gorm book trolley 57x57 h=109 cm, shelf depth 22 cm. Four removable cassettes allows cassettes to easily be lifted off.

- 4052 graphite grey/birch



Lundia

is a stable shelf of solid pine. Each shelf section can bear a load of max 600 kg and the shelves can bear a load of 180-200 kg.

LUNDIA clear varnished storeroom shelves in pine

- HE7 302000330 Open end piece 88x30 cm, pine clear varnish
- 302000430 Open end piece 88x40 cm
- 302001030 Open end piece 138x30 cm
- 302001130 Open end piece 138x40 cm
- 302003830 Open end piece 188x30 cm
- 302003930 Open end piece 188x40 cm
- 302005230 Open end piece 208x30 cm
- 302005330 Open end piece 208x40 cm
- 302005930 Open end piece 218x30 cm
- 302006030 Open end piece 218x40 cm

- 302018930 Filled outer end piece 88x30 cm, pine clear varnish
- 302019030 Filled outer end piece 88x40 cm
- 302019630 Filled outer end piece 138x30 cm
- 302019730 Filled outer end piece 138x40 cm
- 302022430 Filled outer end piece 188x30 cm
- 302022530 Filled outer end piece 188x40 cm
- 302023830 Filled outer end piece 208x30 cm
- 302023930 Filled outer end piece 208x40 cm
- 302024530 Filled outer end piece 218x30 cm
- 302024630 Filled outer end piece 218x40 cm

- 302010230 Filled middle end piece 88x30 cm, pine clear varnish
- 302010330 Filled middle end piece 88x40 cm
- 302010930 Filled middle end piece 138x30 cm
- 302011030 Filled middle end piece 138x40 cm
- 302013730 Filled middle end piece 188x30 cm
- 302013830 Filled middle end piece 188x40 cm
- 302015130 Filled middle end piece 208x30 cm
- 302015230 Filled middle end piece 208x40 cm
- 302015830 Filled middle end piece 218x30 cm
- 302015930 Filled middle end piece 218x40 cm

309004961 Diagonal brace for shelf length 80/100 cm
Diagonal brace is to be fitted to each third section!

- 301000330 Shelves 80x30 cm, pine clear varnished
- 301000430 Shelves 80x40 cm
- 301001030 Shelves 100x30 cm
- 301001130 Shelves 100x40 cm
- 309016430 6-drawer compartment 76.7x40 h=40 cm, internal drawer height 11 cm
- 309016930 12-drawer compartment 96.7x40 h=40 cm, internal drawer height 8 cm
- 309017330 9-drawer compartment 96, 7x40 h=58 cm, internal drawer height 17 cm

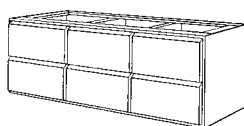

3090 164 30

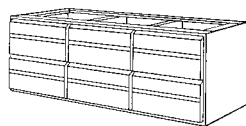

3090 169 30

End pieces available also in other heights and depths and shelves are available in other lengths and depths. Backs, magazine shelves, drawer compartments, doors etc available as option. Can be supplied.

H Drawer units, cupboards, book shelves, wall shelves, pupil cupboards, teacher pigeon holes, library fittings, sheet steel cupboards

Lab cupboard entirely in high pressure laminate

Shell, doors and shelves in high pressure laminate with solid wood edging laminated over. Glass doors fitted with hardened glass and with solid wood frame. Rebated doors with 15 mm solid wood edging. Espagnolette with handle, Abloy cylinder lock on doors 1,200 mm and higher. Lower doors with wood handle. These doors can, on payment of a surcharge, be supplied with cylinder locks. Self closing cast hinges with 180° opening angle. Fitted base. Base height 100 mm or frame height 150 mm.



Depth 600 mm

Height 2,100 mm incl base (Height 2,150 mm incl base)

L40.500.01	Lab cupboard, width 400 mm 1 fixed and 4 movable shelves
L50.500.01	Lab cupboard, width 500 mm 1 fixed and 4 movable shelves
L60.500.01	Lab cupboard, width 600 mm 1 fixed and 4 movable shelves
L80.500.01	Lab cupboard, width 800 mm 1 fixed and 4 movable shelves
L90.500.01	Lab cupboard, width 1,000 mm 1 fixed and 4 movable shelves
L41.500.01	Lab cupboard width 400 mm. Glazed door. 1 fixed and 4 movable shelves
L51.500.01	Lab cupboard width 500 mm. Glazed door. 1 fixed. 4 movable shelves.
L61.500.01	Lab cupboard width 600 mm. Glazed door 1 fixed and 4 movable shelves.
L81.500.01	Lab cupboard width 800 mm. Glazed doors. 1 fixed and 4 movable shelves.
L91.500.01	Lab cupboard width 1,000 mm. Glazed doors. 1 fixed and 4 movable shelves.
L42.400.01	Lab cupboard, split front. Width 400 mm. 4 movable shelves.
L52.400.01	Lab cupboard, split front. Width 500 mm. 4 movable shelves.
L62.400.01	Lab cupboard, split front. Width 600 mm. 4 movable shelves.
L82.400.01	Lab cupboard, split front. Width 800 mm. 4 movable shelves.
L92.400.01	Lab cupboard, split front. Width 1,000 mm. 4 movable shelves.
L43.400.01	Lab cupboard, width 400 mm, glazed top door. Airtight door below. 4 movable shelves.
L53.400.01	Lab cupboard, width 500 mm, glazed top door. Airtight door below. 4 movable shelves.
L63.400.01	Lab cupboard width 600 mm, glazed door above. Airtight door below. 4 movable shelves.
L83.400.01	Lab cupboard width 800 mm, glazed doors above. Air tight doors below. 4 movable shelves.
L93.400.01	Lab cupboard width 1,000 mm. Glazed doors above. Air tight doors below. 4 movable shelves.
	Surcharge for frame grey NCS 3502B
FU lock	Lock for lower cupboard

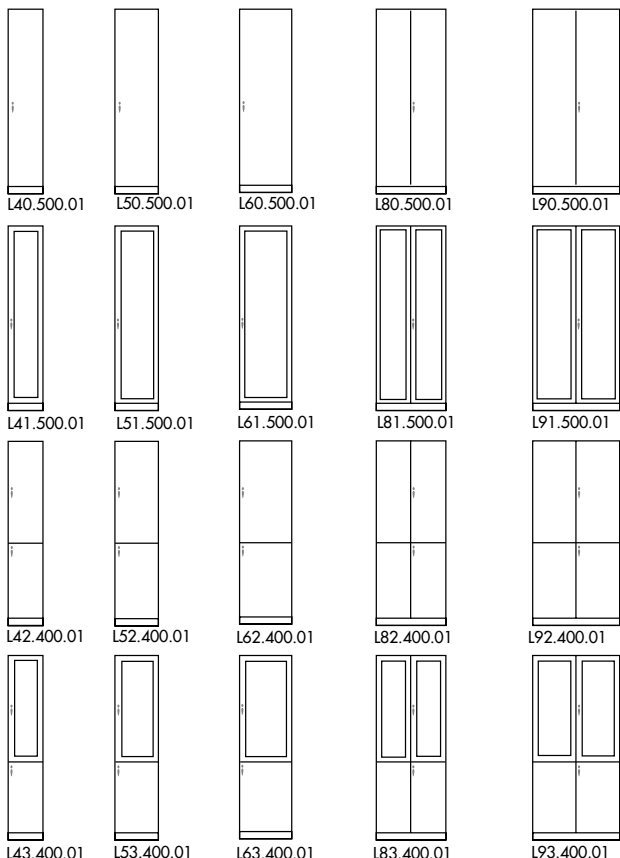



Lab cupboard entirely in high pressure laminate

Shell, doors, drawer fronts and shelves in high pressure laminate with solid wood edging laminated over. Rebated doors with 15 mm solid wood edging. These doors can, on payment of a surcharge, be supplied with cylinder locks. Self closing cast hinges with 180° opening angle. Fitted base. Base height 100 or frame height 150 mm.

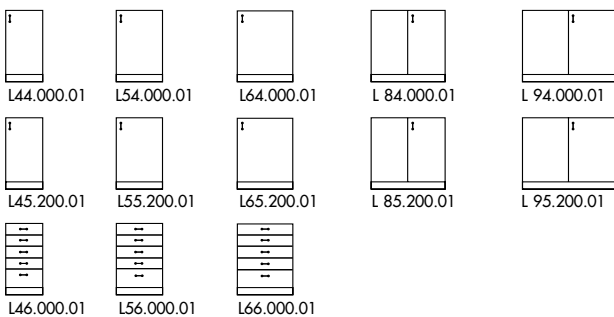

Depth 580 mm, height: 870 mm (incl base), height 920 mm (incl frame)

L44.000.01	Sink unit, width 400 mm
L54.000.01	Sink unit, width 500 mm
L64.000.01	Sink unit, width 600 mm
L84.000.01	Sink unit, width 800 mm
L94.000.01	Sink unit, width 1,000 mm
L45.200.01	Counter unit cupboard, width 400 mm 2 movable shelves
L55.200.01	Counter unit cupboard, width 500 mm 2 movable shelves
L65.200.01	Counter unit cupboard, width 600 mm 2 movable shelves
L85.200.01	Counter unit cupboard, width 800 mm 2 movable shelves
L95.200.01	Counter unit cupboard, width 1,000 mm 2 movable shelves
L46.000.01	Drawer unit width 400 mm, 5 drawer
L56.000.01	Drawer unit width 500 mm, 5 drawer
L66.000.01	Drawer unit width 600 mm, 5 drawer
	Surcharge for frame grey NCS 3502B
FU lock	Lock for lower cupboard



Shell, doors, drawer fronts and shelves in high pressure laminate with solid wood edging laminated over. Glass doors fitted with hardened glass and with solid wood frame. Rebated doors with 15 mm solid wood edging and wood handle. These doors can, on payment of a surcharge, be supplied with cylinder locks. Self closing cast hinges with 180° opening angle.

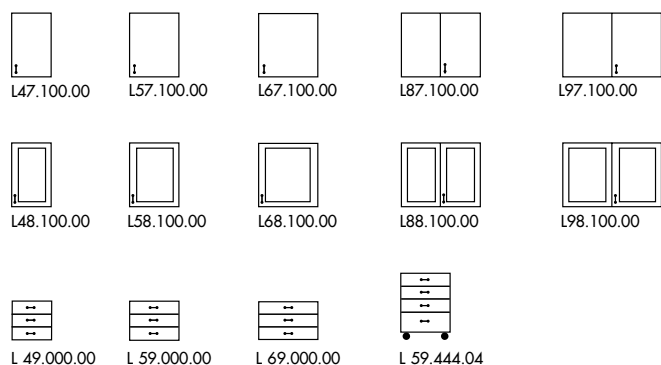

Lab cupboard entirely in high pressure laminate

L47.100.00	Wall cupboard, 400x300x700 mm 1 movable shelf.
L57.100.00	Wall cupboard, 500x300x700 mm 1 movable shelf.
L67.100.00	Wall cupboard, 600x300x700 mm 1 movable shelf.
L87.100.00	Wall cupboard, 800x300x700 mm 1 movable shelf.
L97.100.00	Wall cupboard, 1,000x300x700 mm 1 movable shelf.
L48.100.00	Wall cupboard, 400x300x700 mm 1 movable shelf. Glazed door
L58.100.00	Wall cupboard, 500x300x700 mm 1 movable shelf. Glazed door
L68.100.00	Wall cupboard, 600x300x700 mm 1 movable shelf. Glazed door
L88.100.00	Wall cupboard, 800x300x700 mm 1 movable shelf. Glazed doors.
L98.100.00	Wall cupboard, 1,000x300x700 mm 1 movable shelf. Glazed doors.
L49.000.00	Hanging drawer unit, 400 x 580 x 400 mm 3 drawers
L59.000.00	Hanging drawer unit, 500 x 580 x 400 mm 3 drawers
L69.000.00	Hanging drawer unit, 600 x 580 x 400 mm 3 drawers
L59.444.04	Rolling drawer unit, 500 x 580 x 620 mm (incl wheels 70 mm), 4 drawers.
FU lock	Lock for wall cupboard

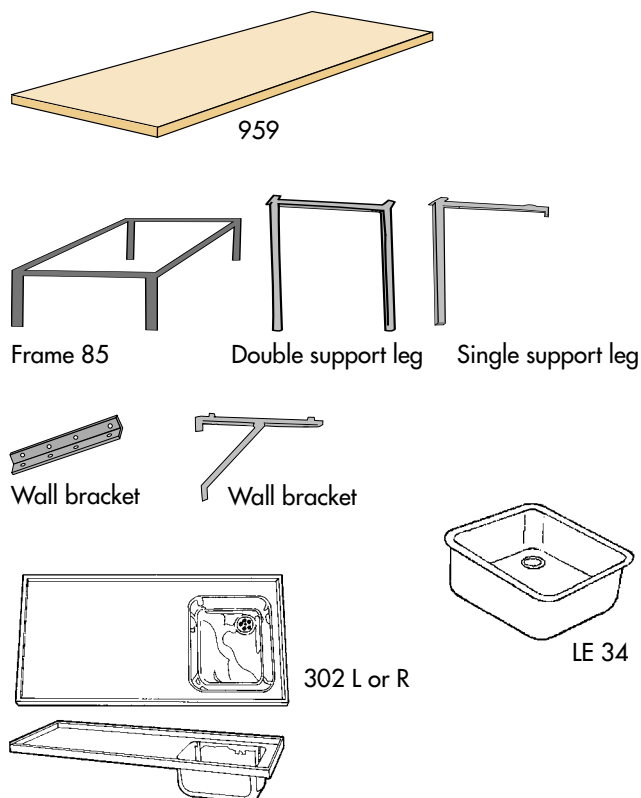

Counter unit tops and fittings

Shell of counter top of 28 mm chipboard which is overlaid with high pressure laminate. Laminated table top in solid wood, thickness 30 mm. Composite table top has homogeneous 12 mm surface layer for joint free fitting of built in sink. Frame and support leg of 30x30 mm steel tubing, epoxy varnished.

959L	Laminate table top, solid edging, depth 60 cm	
957.60 Stav	Laminated table top depth 60 cm	
959K	Composite counter top	Ask for offer
FBL	Raised rear edging 9x50 mm	
85	Frame	Ask for offer
86/87.58	Support leg, single, height 870 mm	
87/87.58	Support leg, double, height 870 mm	
88 B	Wall bracket d=550	
88 C	Wall bracket l=400 mm	
302 L/R	Sink unit fittings 1,000x600 mm with sink LE 34 (340x400 mm) incl. water lock	
LE34	Built in sink 340x400 mm depth 160 mm, incl water lock	
	Multi sink units, see page 55	

New!



Storage

Storage with shell, back and front panels in birch pattern or grey melamine. Drawer in plywood on expansion fitting. Shell and drawer front panel edged with ABS edging. 5 wheels of which 2 with brake. 1,000x450 mm, height 900 mm.

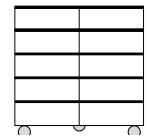

M97.010

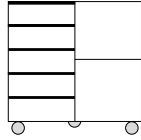

M97.105

- M97.010.1 Storage with 10 drawers, birch melamine
- M97.010.2 Storage with 10 drawers, grey melamine
- M97.105.1 Storage with 5 drawers, birch melamine
- M97.105.2 Storage with 5 drawers, grey melamine

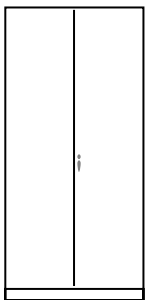

M90.500



Tall cupboard with shell, shelves and doors in birch pattern or grey melamine with ABS edging. Surface mounted doors with espagnolette can be supplied with Abloy cylinder lock. The sides go down to the floor, with a notch in the the rear edge for floor base. Self closing hinges with 130° opening angle. 1 000x450 height 2 100 mm.

- M90.500.1 1 fixed and 4 movable shelves, birch melamine
- M90.500.2 1 fixed and 4 movable shelves, grey melamine
- Lock F cylinder lock Abloy

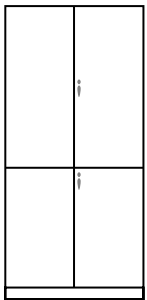

M92.400



Tall cupboard with shell, shelves and doors in birch pattern or grey melamine with ABS edging. Surface mounted doors. Top cupboard has espagnolette which can be supplied with Abloy cylinder lock. Doors below have wood handle and can be supplied with Abloy deadbolt lock. The sides go down to the floor, with a notch in the the rear edge for floor base. Self closing hinges with 130° opening angle. 1 000x450 height 2 100 mm.

- M92.400.1 split front, 4 movable shelves, birch melamine
- M92.400.2 split front, 4 movable shelves, grey melamine
- Lock F cylinder lock Abloy for top cupboard
- FU lock Deadbolt lock Abloy for lower cupboard

H Drawer units, cupboards, book shelves, wall shelves, pupil cupboards, teacher pigeon holes, library fittings, sheet steel cupboards



Sheet steel cupboard



Poison cupboard



Bottled gas cupboard



Fume cupboard

Storage cupboard in sheet steel, white, lockable.

- F84A 1,000x400 h=1,975 mm, 4 movable shelves
- F84B 1,000x400 h=1,295 mm, 2 movable shelves

Fireproof cupboard, white, lockable.

- F2004B 1,000x450 h=2,095 mm, 5 movable shelves
- F2006B 1,000x600 h=2,095 mm, 5 movable shelves
- F1204E 1,000x450 h=1,295 mm, 3 movable shelves
- F804G 1,000x450 h=895 mm, 1 movable shelf
- F806G 1,000x600 h=895 mm, 1 movable shelf

Poison cupboard/chemical cupboard, white, lockable. With ventilation along the cupboards left corner, fireproof.

- G200B 600x600 h=2,095 mm, 5 movable shelves
- G2004B 1,000x450 h=2,095 mm, 5 movable shelves
- G2006B 1,000x600 h=2,095 mm, 5 movable shelves
- G1204E 1,000x450 h=1,295 mm, 3 movable shelves
- G804G 1,000x450 h=895 mm, 1 movable shelf
- G806G 1,000x600 h=895 mm, 1 movable shelf

Bottled gas cupboard with ventilation openings at the rear, white. Complies with Sprängämnesinspektionen's requirements regulations (SÄFIS 1995:2) for storage of inflammable gasses in public premises (schools, hospitals, restaurants etc).

- EI30-GAS1 925x770 h=853 mm
- EI30-GAS2 925x770 h=1,125 mm
- EI30-GAS3 925x600 h=2,000 mm
- EI30-GAS4 925x853 h=853 mm
- EI30L Lock including 2 keys
- EI30VAGN Trolley for bottled gas flasks
- EI30H12 Shelf depth 770 mm
- EI30H3 Shelf depth 600 mm
- EI30UH12 Extractable shelf depth 770 mm
- EI30UH3 Extractable shelf depth 600 mm

School fume cupboard SÖ 1

Fume cupboard SÖ 1 including alarm	Ask for offer
Ventilation sleeve coupling for lower cupboard	Ask for offer
Limit switches, factory fitted	Ask for offer
Glazed sides	Ask for offer



White boards of glass enamelled sheet steel.

Magnets adhere to the surface.

Frame and pen shelf of natural anodized aluminium. Frame protrudes 4 mm. White anodized aluminium frame and frame of beech, birch or oak are available as an option.

Raisable boards - ask for offer.

K:1	Writing boards for felt tipped pens white (V), beige (BE) or light grey (GR):
2810	1,000x1,200 mm
2815	1,500x1,200 mm
2820	2,000x1,200 mm
2825	2,500x1,200 mm
2830	3,000x1,200 mm
2835	3,500x1,200 mm
2840	4,000x1,200 mm
2845	4,500x1,200 mm
2850	5,000x1,200 mm
2899	Cutting cost per section
	Writing boards for chalk, green(G), graphite grey (GG), blue (B) or black (S):
2910	1,000x1,200 mm
2915	1,500x1,200 mm
2920	2,000x1,200 mm
2925	2,500x1,200 mm
2930	3,000x1,200 mm
2935	3,500x1,200 mm
2940	4,000x1,200 mm
2945	4,500x1,200 mm
2950	5,000x1,200 mm
2899	Cutting cost per section
	AV rail without paper holder function incl end stop. Height 18 mm, depth 16 mm.
40022	aluminium, length 3,000 mm
40022V	white length 3,000 mm
	AV rail with paper holder function incl end stop and white trim piece. Height 56 mm, depth 27 mm.
40024	aluminium, length 3,000 mm
40024V	white length 3,000 mm
27837	Writing board 10,00x1,800 with wheel fittings
27838	Writing board 1,500x1,200 with wheel fittings
40031	Wheel set as accessory, white
40032	Wheel set as accessories, grey

	Surcharge for lines
16201	Grid pattern L=1,000 mm
16202	Grid pattern L=2,000 mm
16203	Grid pattern L=3,000 mm
16221	Musical staving L=1,000 mm
16222	Musical staving L=2,000 mm
16223	Musical staving L=3000 mm
	Accessories board 550x1200 mm, white laminated board complete with accessories. Can be assembled vertical or horizontal.
40001	with natural anodized aluminium frame
40001V	with white anodized aluminium frame
	Flip chart trolley 1,055x730 mm. Flip chart holder with adjustable knobs. Frame with wheels both up and down. Can also be hung in a corner.
40116	white board, frame and pen shelf, aluminium
40066	white board, white frame and pen shelf
40118	white drawing surface, frame and pen shelf aluminium
40068	white drawing surface, white frame and pen shelf
40047	Flip chart, 10 pack
400140	Pointer/pull rod l=1,400 mm
	Accessories:
40040	Pens, 12 pack, one colour: red, black, blue or green
40041	Felt tip pens - set of 4
40056	Magnetic holder for 4 pens
40059	Board cleaner with magnet
40060	Felt cloth for board cleaner, 10 pieces
40043	Magnets, black 10 pieces
40044	Cleaning fluid 0.25 l
40045	Starter kit: 4 pens, board cleaner, Felt kit, 9 magnets, cleaning fluid 0.25 l, pen holder

Writing boards, stepless height adjustable 500 mm. Raising mechanism, wall mounted and is hidden behind the writing board. Frame protrudes 4 mm.



K:2

Writing board, height adjustable 50 cm:

3920	2,000x1,200 mm
3925	2,500x1,200 mm
3930	3,000x1,200 mm
3935	3,500x1,200 mm
3940	4,000x1,200 mm

Free standing writing board on wheeled frame, total height 196 cm:

3010	Board size 1,000x1,200 mm
3015	Board size 1,500x1,200 mm
3020	Board size 2,000x1,200 mm

Reversible writing board on wheeled frame

3115	Board size 1,500x1,200 mm
3120	Board size 2,000x1,200 mm

Excello Rail system 2000



Proj. screen on carriage



Wall bracket



Mounting profile



Projection screen in steel cassette



Map carriage

K:3

Excello Rail system 2000. Roof rail, white painted aluminium, incl bracket and end stops

450300	Length 300 cm
450400	Length 400 cm
450500	Length 500 cm
450600	Length 600 cm
	Cutting cost

Mounting profile, white:

460005	for 1 rail on roof 5 cm
460030	for 1-3 rails on roof, 25 cm
460050	for 1-5 rails on roof, 45 cm
485050	Wall bracket for 1-3 rails, 50 cm
485075	Wall bracket for 1-4 rails, 75 cm

Proj. screen on rail system carriage:

SDF1420	Width 140, height 190 cm
SDF1620	Width 160, height 190 cm
SDF1820	Width 180, height 190 cm
SDF2020	Width 200, height 190 cm
SDF2024	Width 200, height 230 cm

Connect proj. screen in white steel cassette for roof or wall mounting:

C1420	Width 140, height 200
C1620	Width 160, height 200 cm
C1820	Width 180, height 200 cm
C200	Width 200, height 200 cm
C240	Width 240, height 240 cm

Diplomat proj. screen in white aluminium cassette for roof or wall mounting (flexible mounting points)

DD1420	Width 140, height 200
DD1620	Width 160, height 200 cm
DD1820	Width 180, height 200 cm
DD200	Width 200, height 240 cm
DD240	Width 240, height 240 cm

340000	Magnet band for proj. screen for OH-display
340004	Super magnet with hook
485050	Bracket for proj. screen 50 cm, piece
485075	Bracket for proj. screen 75 cm, piece
421010	Rolling carriage for proj. screen in housing, pair
K100	Map lift in cassette for rail system
421102	Map carriage for school maps, pair
400140	Pointer/pull rod l=140 cm

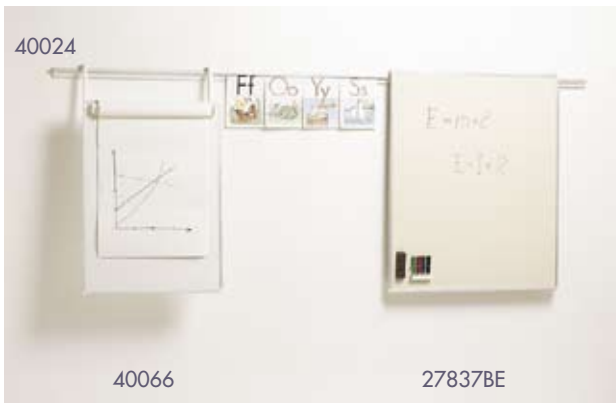

K:4

AV rail without paper holder function incl end stop. Height 18 mm, depth 16 mm.

- 40022 aluminium, length 3,000 mm
- 40022V white, length 3,000 mm

AV rail with paper holder function incl end stop and white trim. Height 56 mm, depth 27 mm.

- 40024 aluminium, length 3,000 mm
- 40024V white, length 3,000 mm
- 27837 Writing board 1,000x1,200 mm with wheel fittings
- 27838 Writing board 1,500x1,200 mm with wheel fittings

Flip chart trolley 1,055x730 mm.
Flip chart holder with adjustable knobs.
Frame with wheels both up and down.
Can also be hung in a corner.

- 40116 white board, frame and pen shelf, aluminium
- 40066 white board, white frame and pen shelf
- 40118 white drawing surface, frame and pen shelf aluminium
- 40068 white drawing surface, white frame and pen shelf
- 40047 Flip chart, 10 pack



K:5

Notice board of 12 mm porous board upholstered with natural linen fabric, folded edges.

- 140612 600x1,200
- 140812 800x1,200
- 141012 1,000x1,200
- 141512 1,500x1,200
- 142012 2,000x1,200
- 142512 2,500x1,200
- 143012 3,000x1,200

Notice board of 12 mm porous board covered with natural linen fabric, frame of natural anodized aluminium.

- 120906 915x615, without support frame
- 121206 1215x615, without support frame
- 121210 1,215x1,015
- 121512 1,515x1,215
- 122012 2,015x1,215
- 122512 2,515x1,215
- 123012 3,015x1,215
- 124012 4,015x1,215

Notice board of 12 mm porous board covered in natural linen fabric, frame of beech, birch or oak.

- 110806 800x600
- 111206 1,200x600
- 111210 1,200x1,000
- 111512 1,500x1,200
- 112012 2,000x1,200
- 112512 2,500x1,200
- 113012 3,000x1,200
- 114012 4,000x1,200

Notice board of 10 mm chipboard overlaid with 4.5 mm cork linoleum, bevelled edge (without frame).

- 240806 800x600
- 241008 1,000x800
- 241010 1,000x1,000
- 241510 1,500x1,000
- 242010 2,000x1,000
- 242510 2,500x1,000
- 243010 3,000x1,000

Notice boards up to 2,015 mm can be supplied without support frame.

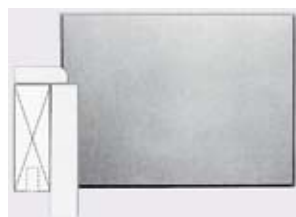

Colours, cork linoleum:

- 1191 grey beige
- 1166 light brown
- 1112 dark grey blue
- 1111 light grey green
- 1110 light grey
- 1109 dark grey
- 1108 grey
- 1107 brown
- 1106 beige
- 1103 turquoise
- 1102 burgundy
- 1101 brick red



Notice boards up to 2,015 mm can be supplied without support frame.

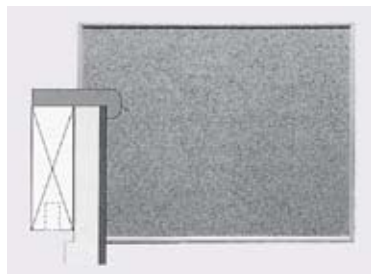
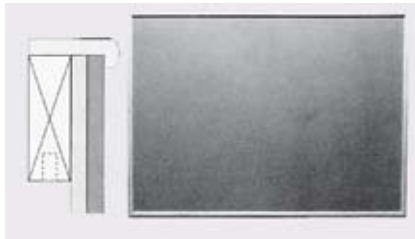
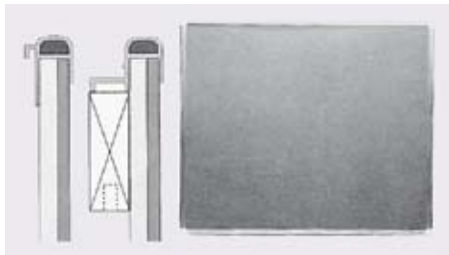

Magazine shelves

K:5 contd.

Notice board of 6 mm chipboard overlaid with 4.5 mm cork linoleum, frame of aluminium.

220806	815x615, without support frame
221008	1015x815, without support frame
221010	1015x1015
221510	1,515x1,015
222010	2,015x1,015
222510	2,515x1,015
223010	3,015x1,015
224010	4,015x1,015

Notice board of 6 mm chipboard overlaid with 4.5 mm cork linoleum, frame of beech or birch (for oak frame, surcharge of 5%).

210806	800x600
211008	1,000x800
211010	1,000x1,000
211510	1,500x1,000
212010	2,000x1,000
212510	2,500x1,000
213010	3,000x1,000
214010	4,000x1,000

Notice board of 12 mm porous board overlaid with 2 mm continuous natural cork, frame of aluminium.

420906	915x615, without support frame
421206	1215x615, without support frame
421210	1,215x1,015
421512	1,515x1,215
422012	2,015x1,215
422512	2,515x1,215
423012	3,015x1,215

Notice board of 12 mm porous board overlain with 2 mm continuous natural cork, frame of beech or or birch (for oak frame, surcharge of 5%)

410806	800x600
411206	1,200x600
411210	1,200x1,000
411512	1,500x1,200
412012	2,000x1,200
412512	2,500x1,200
413012	3,000x1,200

Magazine shelf of solid beech or birch with white painted back. Total depth 70 mm.

8300	Magazine shelf 60x80 cm
8305	Magazine shelf 120x80 cm
8310	Magazine shelf 60x120 cm



K:6

Conference cupboard containing white writing board, flip chart holder on left door inside, pen shelf and film screen for overheads and slides. The doors are equipped with a hinge which allows locking in two positions 135° and 180°. 1,510x1,200 mm, depth 110 mm.

- 56120 Conference cupboard M200 in beech foil
- 56220 Conference cupboard M200 in birch foil
- 55120 Conference cupboard C200 in natural beech
- 55220 Conference cupboard C200 in natural birch
- 55420 Conference cupboard C200 in natural oak
- 40048 Conference set: 4 pens, board cleaner, felt kit, 9 magnets, pen holder, flip chart, cleaning fluid.
- 40056 Magnetic holder for 4 pens
- 41100 Writing board on door
- 41419 Wheel frame, white
- 41423 Wheel frame, black
- 41413 Wheel frame, light grey



A:2 129 24 8 Table height 90 cm, birch laminate, black frame
 159 8 Chair, adjustable 50-80 cm, black frame



A:6 200 24 26808 Table 120x60 cm, height 90 cm, birch laminate, black frame
 200 24 26818 Table 120x60 cm, h 90 cm, bracket for 2 chairs, 160 on one long side.
 200 24 26828 Table 120x60 cm, h 90 cm, bracket for 2 chairs 160 on short sides.
 200 24 27808 Table 120x70 cm, height 90 cm, birch laminate, black frame
 200 24 27818 Table 120x70 cm, h 90 cm, bracket for 4 chairs 160 on long sides.
 200 24 27828 Table 120x70 cm, h 90 cm, bracket for 2 chairs 160 on short sides.
 209 24 26808 Semicircular table 120x60, h 90cm birch laminate, black frame
 209 24 26828 Semicircular table 120x60, h 90cm bracket for two chairs
 160 8 Chair with adjustable footrest, adjustable height 50-80 cm



A:10 494 000 BJ Pupil storage 10 drawers, birch veneer
 294 100 BJ Pupil storage 10 drawers, file bay, birch veneer



B:2 166 24 76468 Table 70x60 cm, h 72 cm, birch laminate, black frame, bracket for chair.
 151 44 8 Chair height 44 cm, black frame
 141 44 8 Suzan chair height 44 cm, black frame
 141 48 8 Suzan chair height 48 cm, black frame

Supply of smaller volumes within two weeks, however not in July and August. For more information on the quick delivery range, see our catalogue under tab



- B:6 156 62 8 Chair with footrest, height 62 cm, black frame
 146 62 8 Suzette chair with footrest, height 62 cm, black frame
- F:10 118 44 8 Stool height 44 cm, black frame
 119 60 8 Stool with footrest, height 60 cm, black frame



- D:1 231 24 27408 Zeb table 120x70 cm, height 72 cm, birch laminate, black frame,
 231 24 27468 Zeb table 120x70 cm, h 72 cm, birch laminate, black frame, bracket for 4 chairs.
- 231 24 87408 Zeb table 180x70 cm, height 72 cm, birch laminate black frame
 231 24 87468 Zeb table 180x70 cm, h 72 cm, birch laminate, black frame, bracket for 6 chairs.
- 141 44 8 Suzan chair height 44 cm, black frame



- D:3 200 24 26408 Table 120x60 cm, height 72 cm, birch laminate, black frame
 200 24 26468 Table 120x60 cm, h 72 cm, birch laminate, black frame, bracket for 2 chairs on one long side
- 200 24 27408 Table 120x70 cm, height 72 cm, birch laminate, black frame
 200 24 27468 Table 120x70 cm, h 72 cm, birch laminate, black frame, bracket for 4 chairs on long sides
- 200 24 87408 Table 180x70 cm, height 72 cm, birch laminate, black frame
 200 24 87468 Table 180x70 cm, h 72 cm, birch laminate, black frame, bracket for 6 chairs on long sides.
- 209 24 26408 Semicircular table 120x60, h 72 cm birch laminate, black frame
 209 24 26468 Semicircular table 120x60, h 72 cm birch laminate, black frame, bracket for two chairs
- 151 44 8 Chair height 44 cm, black frame
- D:1 141 44 8 Suzan chair, height 44 cm, black frame



239

- E:1 239 24 96508 PC table 90x60 cm, height 76 cm, birch, black frame.
 239 24 26508 PC table 120x60 cm, height 76 cm, birch, black frame.



310

229

- E:1b 229 24 26508 PC table Doz height 76 cm, birch laminate, black frame
 310-1-07 Work chair upholstered in Oxford 7 blue fabric



3203

- 3203 3-seat sofa Scania in birch, b=194 cm
 Upholstery fabric Global 153 blue or Global 167 burgundy.



111 500.45 BJ

220 300 + 411 200.45 BJ

- H:2 111 500.45 BJ Cupboard 100x45, height 210 cm, birch veneer, espagnolette with lock
 220 300+ Cupboard 100x45, height 210 cm, 411 200.45 BJ top doors glazed, espagnolette with lock. Birch veneered lower doors with wood handle.

Item no.	Table replacement parts:	
816 . .	Lid, beech (16) or birch laminate (24) with front for table 112-129	65x55 cm
812 . . 076	Table top beech (16) or birch laminate (24) for table 164-169	70x60 cm
812 . . 086	Table top beech (16) or birch laminate (24) for table 164-169	80x60 cm
812 . . 126	Table top beech (16) or birch laminate (24) for larger table	120x60 cm
812 . . 146	Table top beech (16) or birch laminate (24) for larger table	140x60 cm
812 . . 127	Table top beech (16) or birch laminate (24) for larger table	120x70 cm
812 . . 147	Table top beech (16) or birch laminate (24) for larger table	140x70 cm
812 . . 167	Table top beech (16) or birch laminate (24) for larger table	165x70 cm
812 . . 187	Table top beech (16) or birch laminate (24) for larger table	180x70 cm
812 . . 128	Table top beech (16) or birch laminate (24) for larger table	120x80 cm
812 . . 148	Table top beech (16) or birch laminate (24) for larger table	140x80 cm
812 . . 188	Table top beech (16) or birch laminate (24) for larger table	180x80 cm
812 . . 122	Table top beech (16) or birch laminate (24)	120x120 cm
814 . . 120	Round table top beech (16) or birch laminate (24)	ø120 cm
814 . . 150	Round table top beech (16) or birch laminate (24)	ø150 cm
814 . . 070	Round table top beech (16) or birch laminate (24)	ø70 cm
814 . . 090	Round table top beech (16) or birch laminate (24)	ø90 cm
815 . . 126	Semicircular table top beech (16) or birch laminate (24)	120x60 cm
815 . . 147	Semicircular table top beech (16) or birch laminate (24)	140x70 cm
821 10 129	Complete footrest for table 123-129	
853 99 154	Mounting for post delivery fitting on table 200 for chairs with 5-foot pedestal	
853 99 141	Mounting for post delivery fitting on table 200 for 4 leg chairs etc.	
941 21 00	Floor protector of plastic, 21 mm (table 112, 126)	
941 28 00	Floor protector of plastic, 28 mm (table 166, 169, etc.)	
941 32 00	Floor protector of plastic, 32 mm (table 200 etc.)	
941 40 20	Floor protector 40x20 for table 202,205,207	
861 10 1126	Loose extension leg incl. bolt and floor protector, standard length, brown epoxy	
861 10 1127	Loose extension leg incl. bolt and floor protector, 10 cm longer than std, brown epoxy	
	Chair replacement parts:	
801 10 145	Seat of birch 145	
801 20 145	Seat back of birch 145	
901 10 150	Seat of birch 150-160 (small model)	
801 20 150	Seatback of birch, upper 150-160 (small model)	
801 25 150	Seatback of birch, lower 150-160 (small model)	
901 10 151	Seat of birch 151-158 (large model)	
801 20 151	Seatback of birch, upper 151-158 (large model)	
801 25 151	Seatback of birch, lower 151-158 (large model)	
901 10 1411	Seat of birch 141 front section	
901 10 1412	Seat of birch 141 middle section	
901 10 1413	Seat of birch 141 rear section	
801 20 141	Seatback of birch 141, upper	
801 25 141	Seatback of birch 141, lower	
801 20 142	Seatback of birch 142-143	
801 20 144	Seat back of birch 144	
801 20 147	Seat back of birch 147	
801 20 148	Seat back of birch 148	
801 20 171	Seatback of birch 171-176, 181-186	
901 10 118	Round stool seat of birch	
944 99 351	Seat and seatback of plastic 351-367 (large model) - per kit	
821 10 155	Complete footrest for adjustable pupil chairs with pedestal	
941 22 00	Floor protector of plastic, 22 mm	
941 19 90	Inner floor protector for internal Ø 19 mm	
941 28 10	Floor protector of plastic for pedestal chairs - 5-foot pedestal (28 mm)	
941 22 50	Rubber floor protector 22 mm	
943 22 15	Pivoted floor protector with nylon wear surface for internal Ø 19 mm	
943 22 16	Pivoted floor protector with felt wear surface for internal Ø 19 mm	
941 22 70	Floor protector 'Tofflan', 22 mm	>100 pieces <100 pieces

Laminate colours



We use Formica's high pressure laminate, thickness 0.8 mm, as table top surface on our tables. Surface structure is Universal (UN) or Velour (VEL).

Standard colours without surcharge:



K 6149 UN Light Oak (oak)



K 7024 UN Birch (birch)

Standard colours, 5 % surcharge on table price:

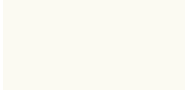

K 1040 UN Alpino



K 2081 UN Sparta



F 7924 VEL Lead



F 2253 VEL Diamond Black



F 7940 VEL Spectrum Yellow



F 7845 VEL Spectrum Red



F 7966 VEL New Burgundy



K 7016 UN Finn Beech (beech)



F 7897 VEL Spectrum Green



F 7967 VEL Hunter Green



F 7851 VEL Spectrum Blue



F 7914 VEL Marine Blue

(Formica's other ranges can be supplied.)

Laminate colours for STRONG range

e = economy

c = comfort

v = vision

table tops: melamine



U 713 grey

high pressure laminate



H 1727 birch

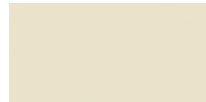

U 182 beige

high pressure laminate



U 713 grey



U 306 red

optional colours
as specified above

chairs: melamine



H 1727 birch

high pressure laminate



H 1727 birch

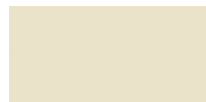

U 182 beige

high pressure laminate



U 713 grey



U 306 red

optional colours
as specified above

Frame colours

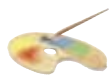

Tranås Skolmöbler surface treats all steel tubing furniture frames with epoxy powder. The powder is electrostatically applied and is hardened in an oven at a temperature of 200°. The method gives an extremely wear resistant surface.

Standard colours



Black (semi matt)
RAL 9005



Grey metallic
RAL 9007



Silver
RAL 9006

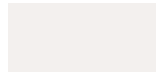

White
RAL 9002 close
NCS 1103-G95Y



Burgundy
RAL 3005



Blue
RAL 5003

Option 1 = without surcharge but longer delivery time.

Option 2 = special, ask for offer



Beige
RAL 1001



Brown
RAL 8028



Red
RAL 3000



Green
RAL 6026

Other RAL colours can also be supplied.

Fabric colours

Fabric class 1 PHOENIX

- 100% Xtreme Stretch (polyester)
- wear resistant 100.000 Martindale cycles
- flameproof
- wash using water 60°



YP019



YP030



YP051



YP07



YP105



YP107



YP108



YP109



YP110



YP111



YP112



YP113



YP114



YP011



YP016



YP021



YP024



YP026



YP027



YP045



YP106



YP046



YP047



YP076

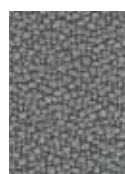

YP081



YP082



YP084



YP005



YP009



YP100

More fabric samples on the next page >>>

Fabric class 2 GLOBAL

- 100% wool
- wear resistant 100,000 Martindale cycles
- flameproof
- foam wash, dry clean



G 131 grey



G 135 green



G 147 red



G 153 blue



G 167 burgundy



G 171 black

Fabric class 3 ABC

- 100% polyester Trevira CS
- wear resistant 50,000 Martindale cycles
- flameproof
- wash using water 60°

Picture ABC 50% of actual size



A 111 green



A 555 blue



A 888 red

Fabric class 3 ECLIPSE 2

- 100% polyester Trevira CS
- wear resistant 50,000 Martindale cycles
- flameproof
- wash using water 60°



E 111 green



E 555 blue



E 560 light blue



E 685 lilac

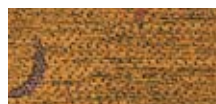

E 780 orange



E 808 red

Fabric class 4 MOVIK

- 92% wool, 8% polyamide
- wear resistant 114,000 Martindale cycles
- flameproof
- foam wash
- Available also as single colour and with wider edge.
- Single coloured black = M107.



M 208 grey/black



M 223 green/black



M 234 red/black



M 245 blue/black



M 265 beige/black

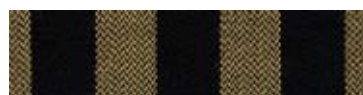

M 282 yellow/black

Fabric class 4 EFFECT

- 90% polyester, 10% polyamide
- wear resistant 110,000 Martindale cycles
- flameproof
- foam wash, dry clean
- Also available with block rib (Effect Rand)



EF 373 blue mottled



EF 73 blue

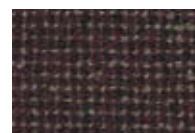

EF 387 burgundy mottled



EF 87 burgundy



EF 380 beige mottled



EF 80 beige



EF 381 black mottled



EF 91 black

Fabric class 4 FINNDAL/FRODAL

- 96% wool, 4% polyamide
- wear resistant 73,000 Martindale cycles
- flameproof
- wash using water 40°



FI 661 red

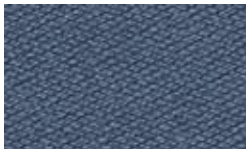

FI 721 grey/blue

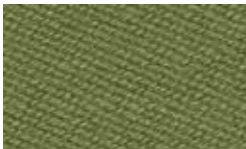

FI 961 green



FR 660 red



FR 720 grey/blue



FR 930 green



SONO