

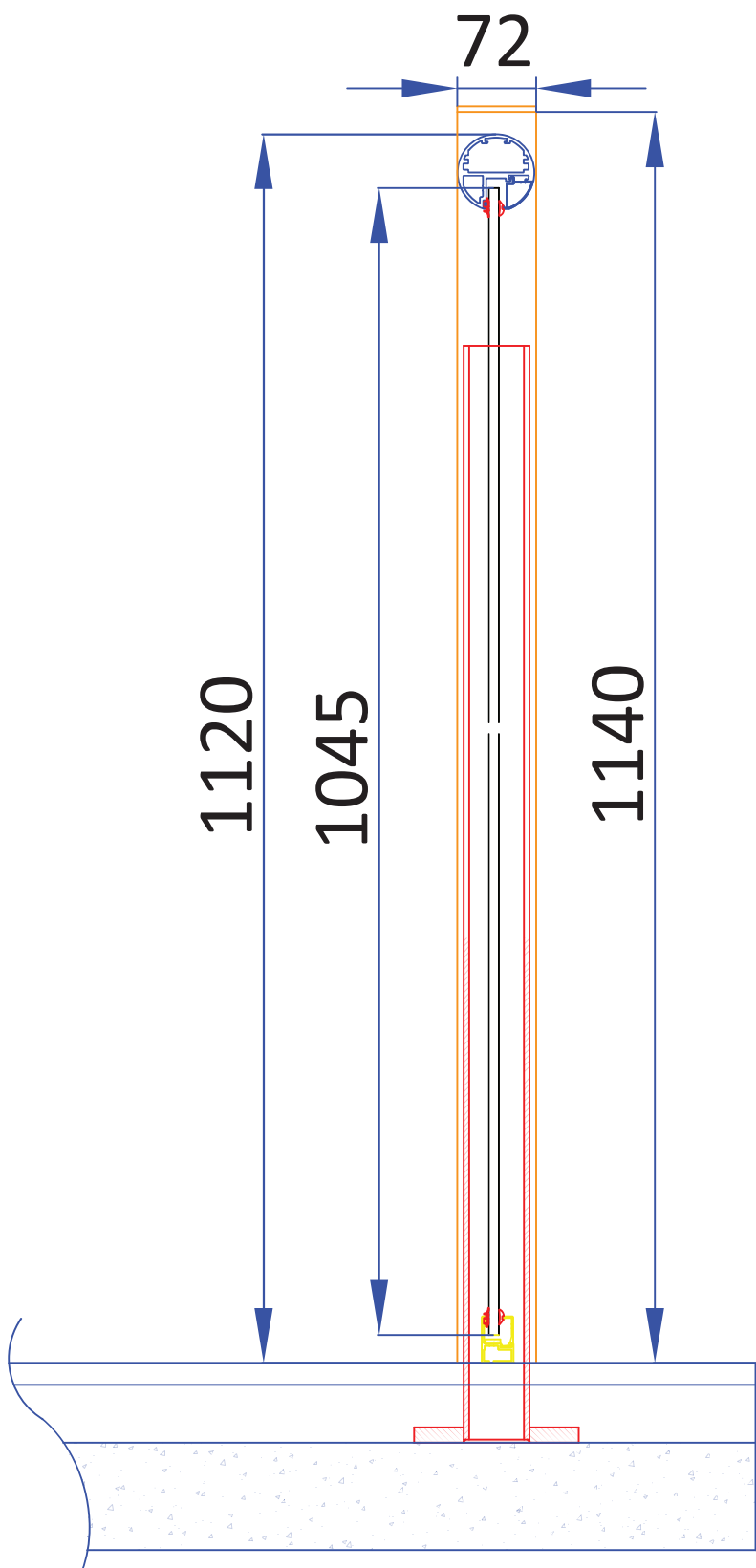

Balcony System 1 Installation Instructions  
Balconette 2016  
[www.balconette.co.uk](http://www.balconette.co.uk)



Tel: +44 1342 410411  
Fax: +44 1342 410412

Unit 6, Systems House, Eastbourne Road,  
Blindley Heath, Lingfield,  
Surrey, RH7 6JP, United Kingdom

- 1) Check you have all the parts of the order.
- 2) Check the height of the glass
- 3) Check the height of the posts
- 4) Check both these heights against the required height on site making sure they are correct before assembling

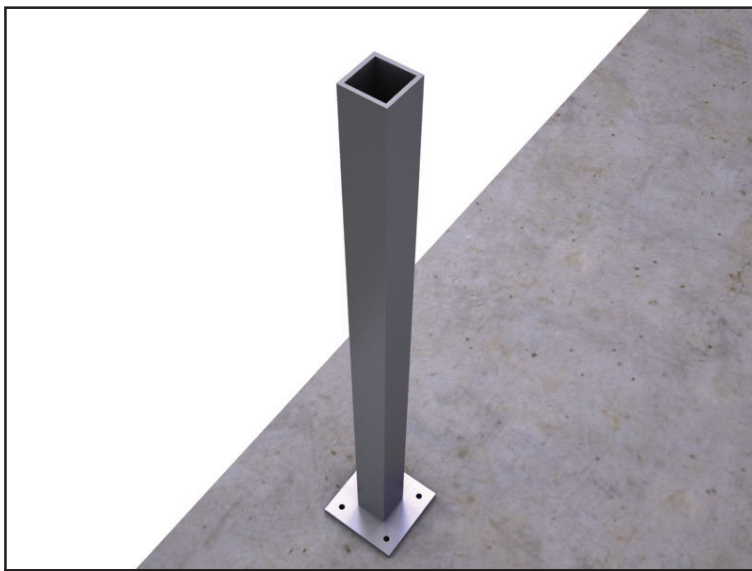

5 Position the primary steel post in the correct position

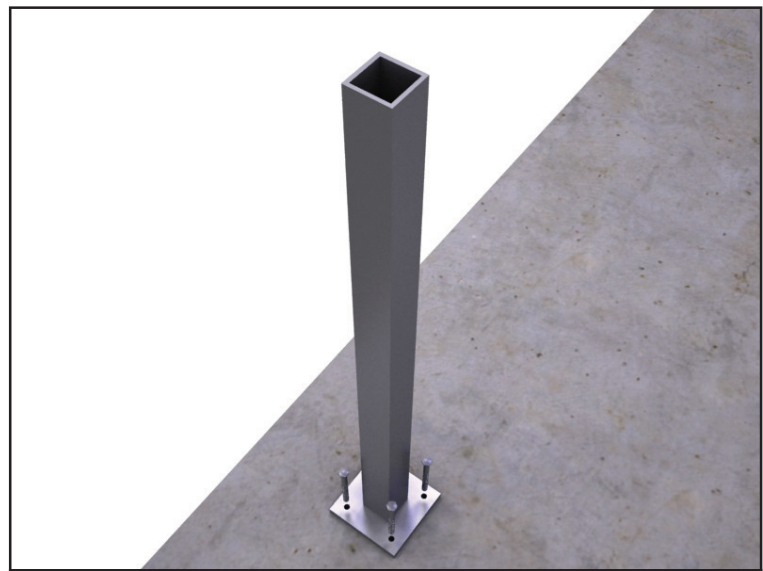

6 Use the appropriate fixings

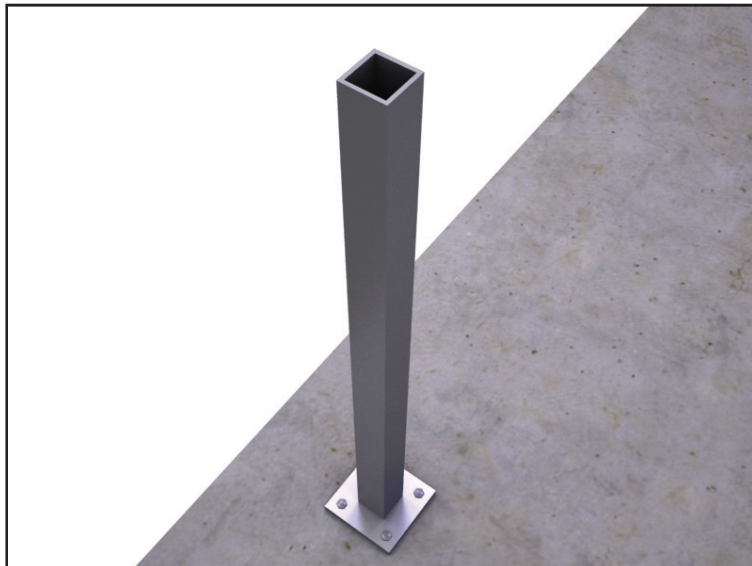

7 Fix the post firmly to the structure making sure they are perfectly vertical



8 Finish the flooring, decking, screed, floor finish etc. to the required height. This should conceal the base plate and bolts.

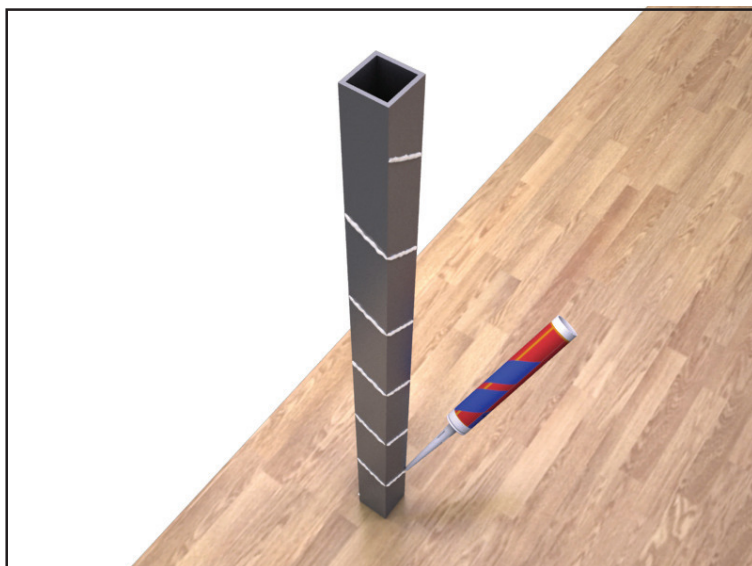

9 Apply a thick bead of silicone sealant around the primary steel post in a spiral fashion

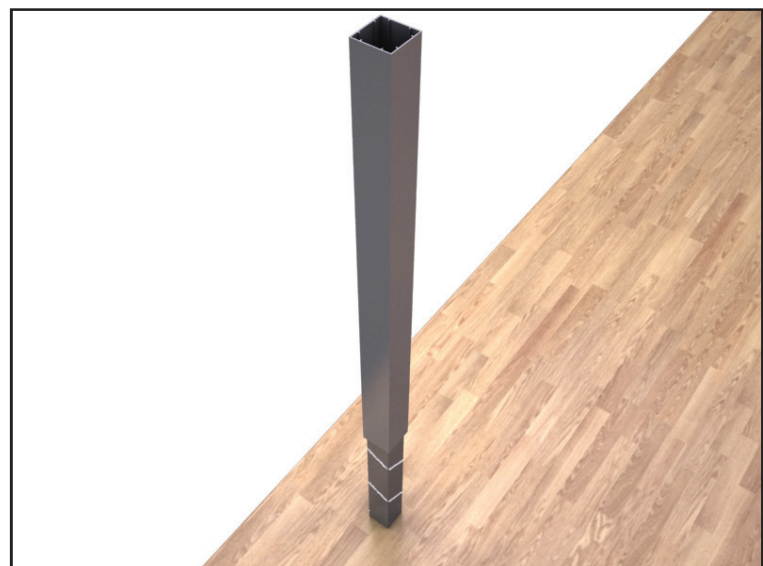

10 Slide the system cover post onto the primary post



11 Ensure the cover post is in position



12 Prepare to place the cap



13 Inject an additional amount of silicone into the gaps between the steel post and cover post on the inside

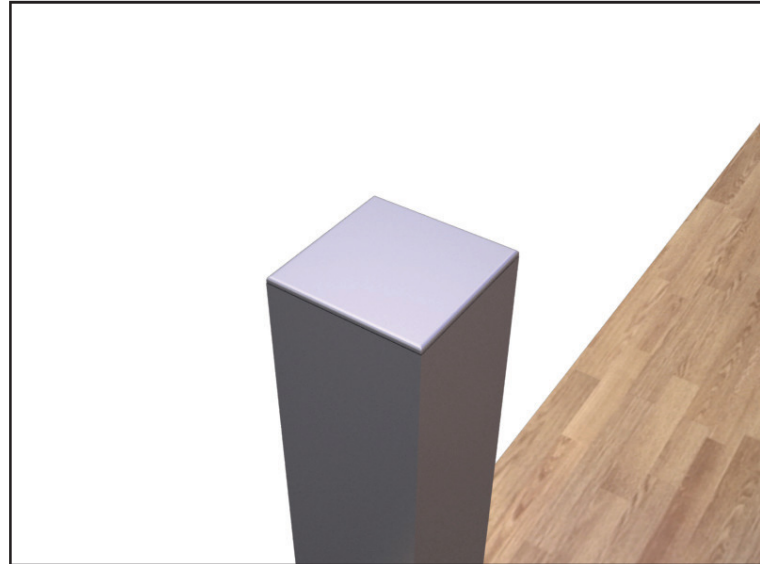

14 Cap the post using the end cap

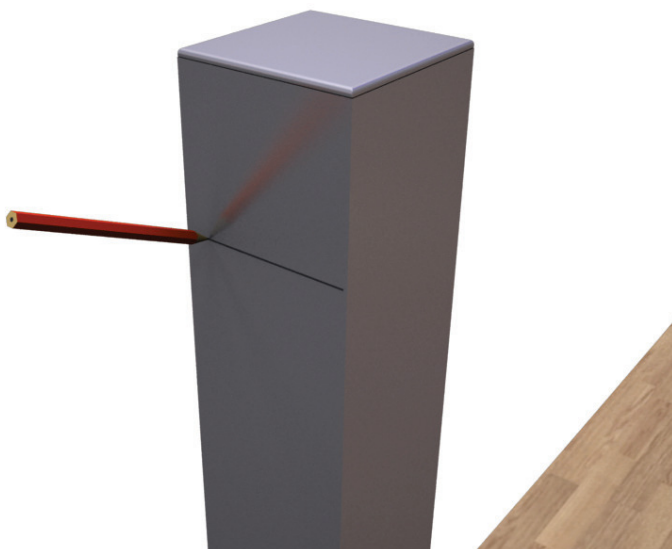

15 Using a level mark the position required to fix the handrail fixing bracket.



16 Bring the fixing bracket in place

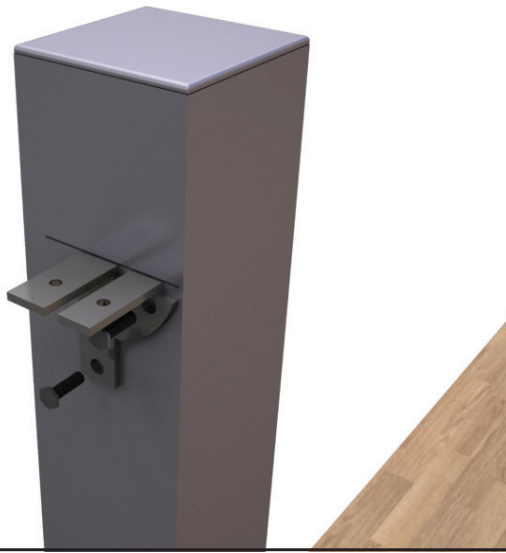

17 Use the appropriate fixings

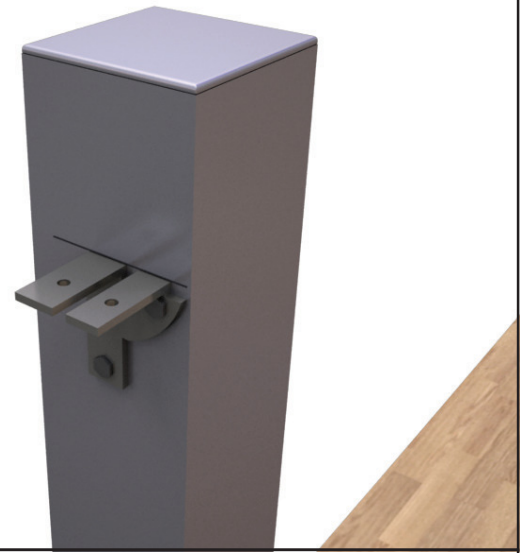

18 Secure the fixing bracket to the post



19 Bring the handrail into position



20 Drop the handrail onto the bracket



21 Drill 4mm holes through brackets into the handrail



22 Secure the handrail to the bracket



23 Repeat this step for all posts



24 Place the bottom track into position

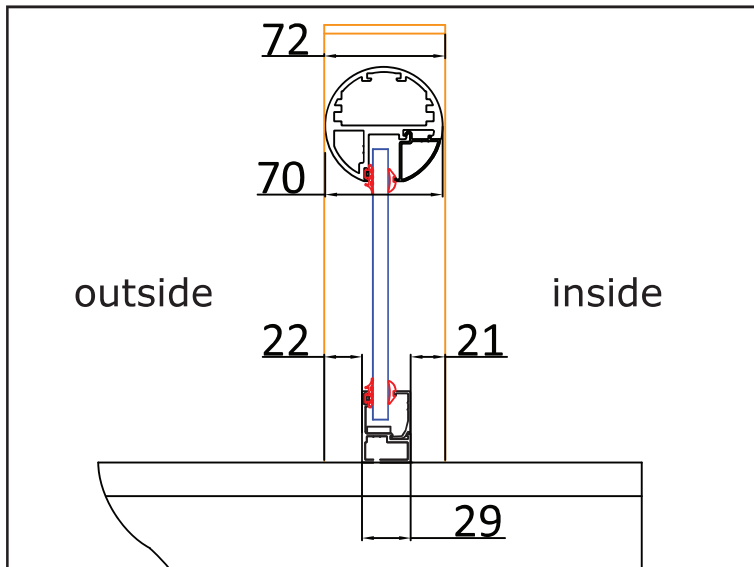

25 Use these dimensions to correctly line up handrail and bottom rail.

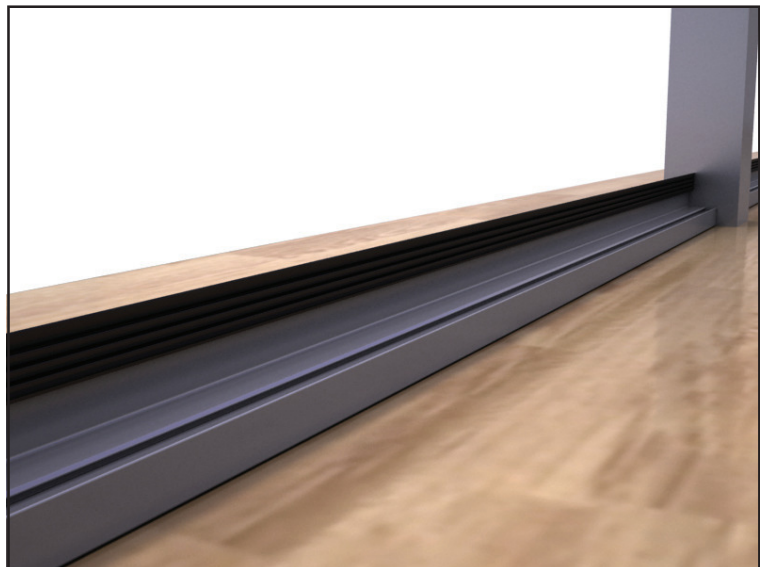

26 Bottom rail in position

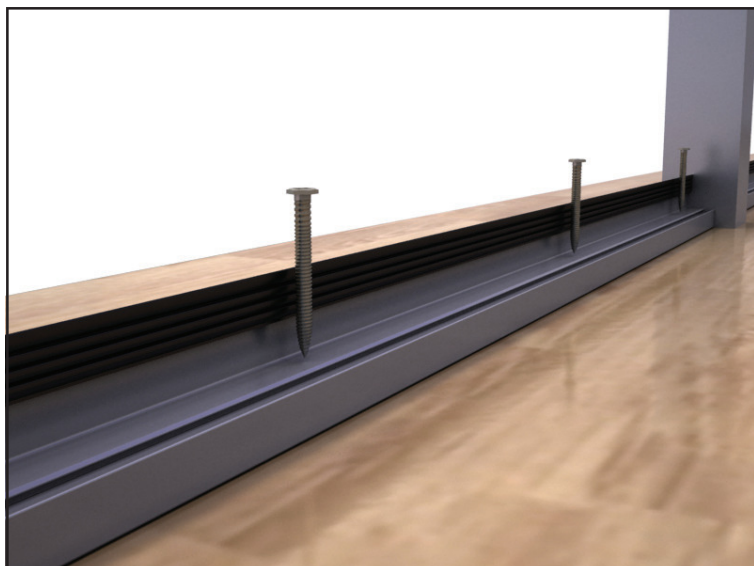

27 Drill into the floor/structure through the bottom rail to fix it

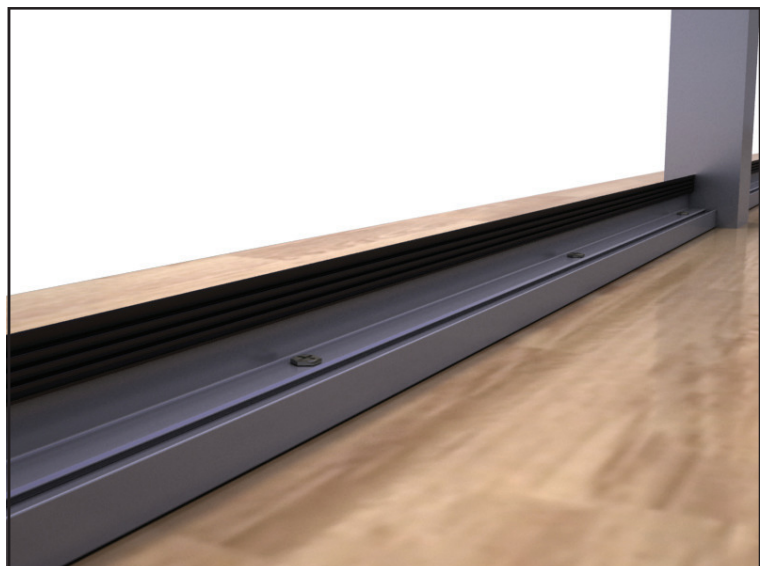

28 Secure the fixings to the bottom rail

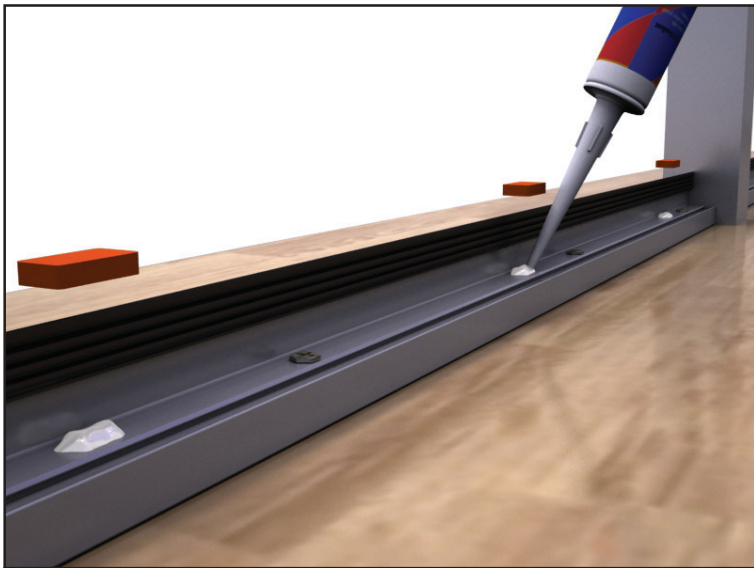

29 Place two 5mm (orange) spacers per required glass panel onto the bottom rail



30 Use silicone to stick them to the bottom rail



31 Place two 5mm (orange) spacers per required glass panel onto the bottom rail

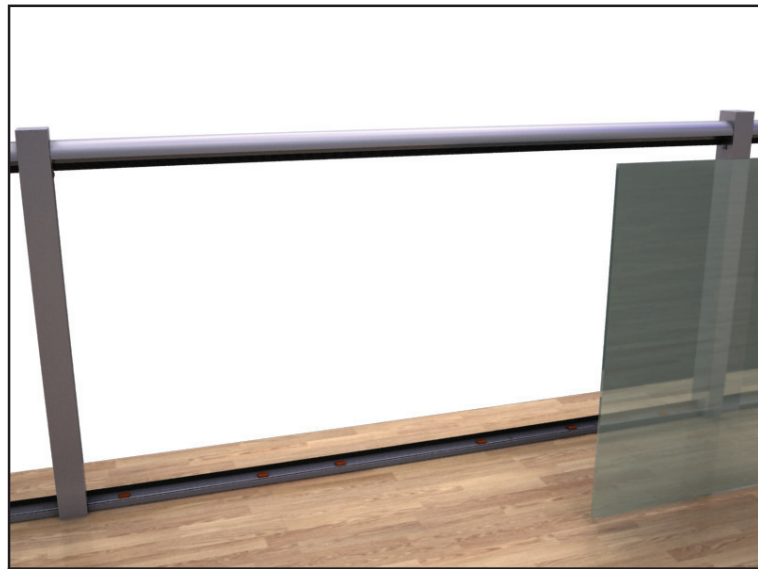

32 Identify glass sizes and where they are to go



33 Place one glass panel at a time into position



34 Use the short pieces of glazing bead to temporarily hold the glass in position

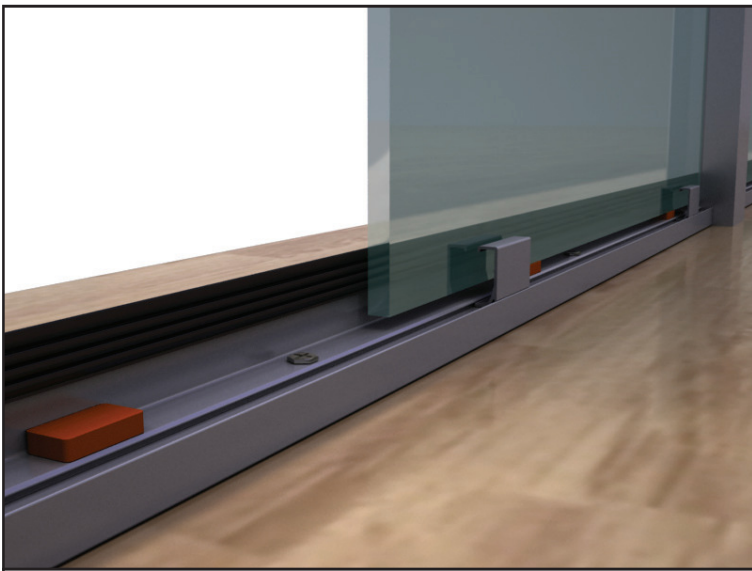

35 Bottom rail glazing beads in position

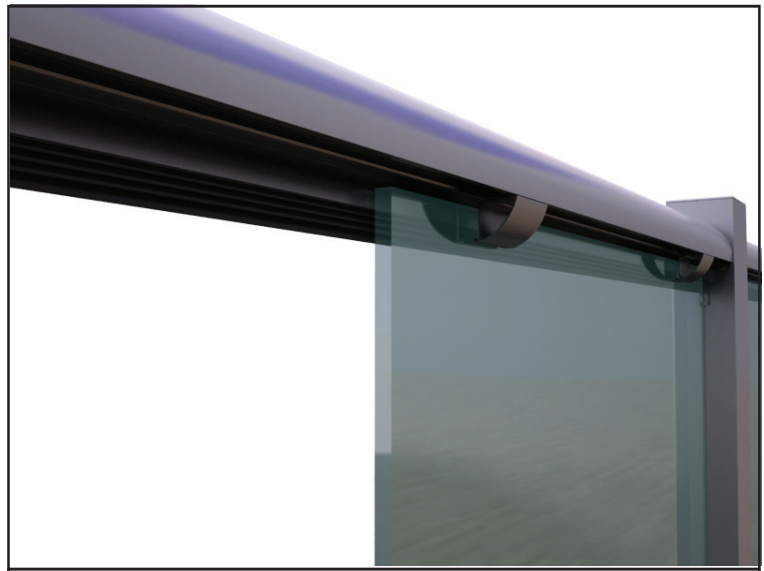

36 Handrail glazing beads in position



37 Use 3mm rubber gaskets to hold the glass against the small bead pieces on the bottom rail

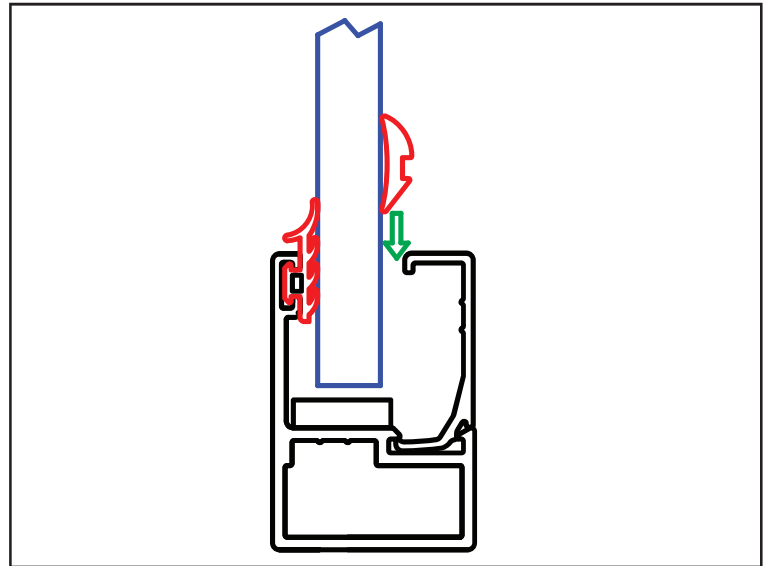

38 Using soapy water can make it easier to push rubber in

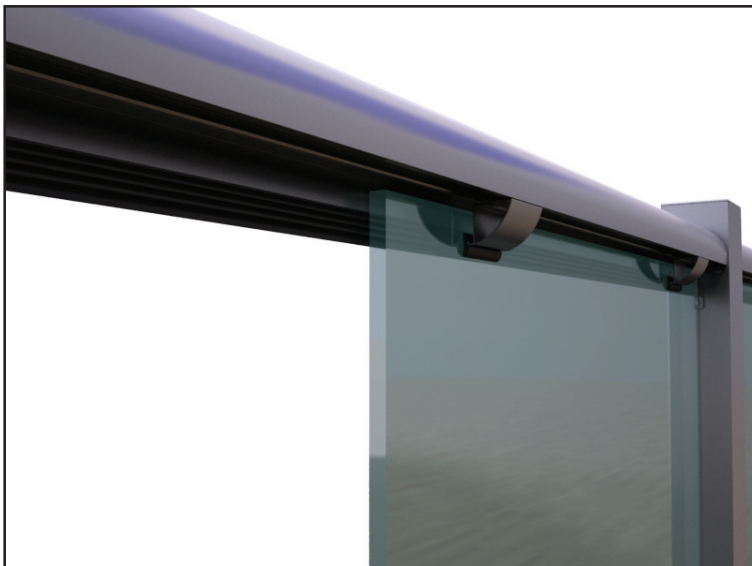

39 Use 3mm rubber gaskets to hold the glass against the small bead pieces on the handrail

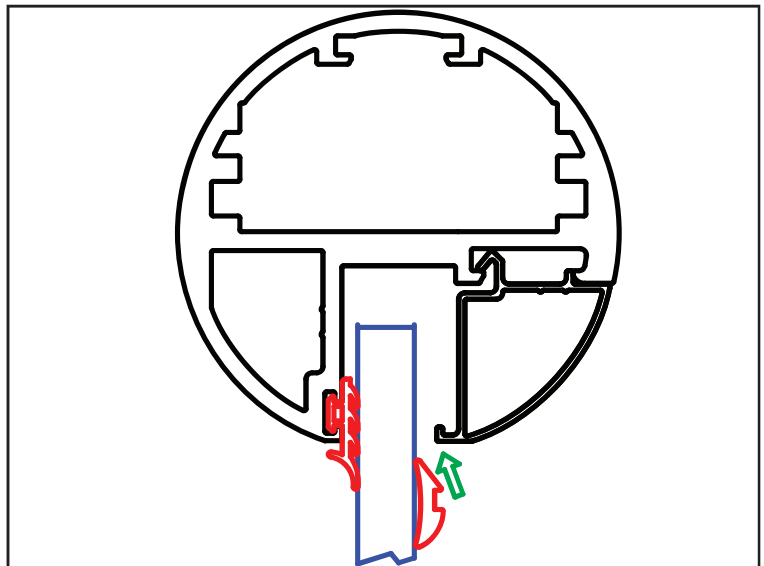

40 Using soapy water can make it easier to push rubber in

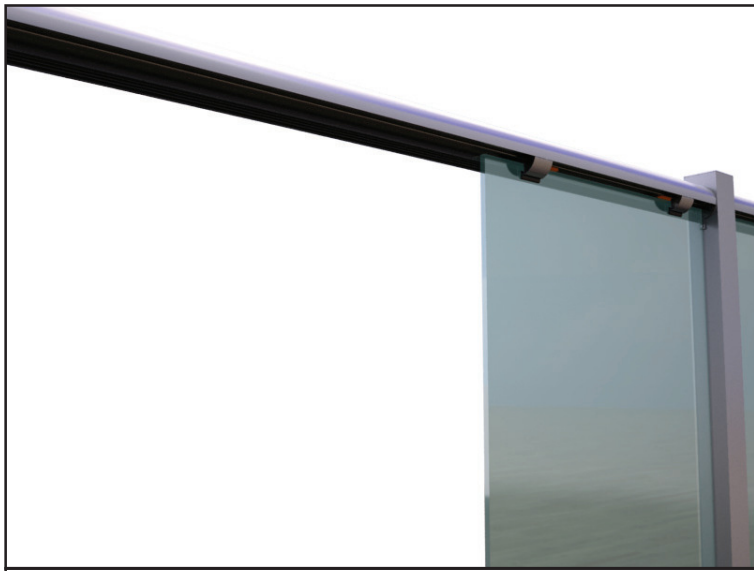

41 Place the spacers on top of the glass so that the handrail doesn't sit on the glass



42 One at a time position each glass in its correct position



43 Repeat this process for each of the following glass panels



44 Align all the glass panels to have correct gaps. Use the glazing packers to lift one side or the other as needed

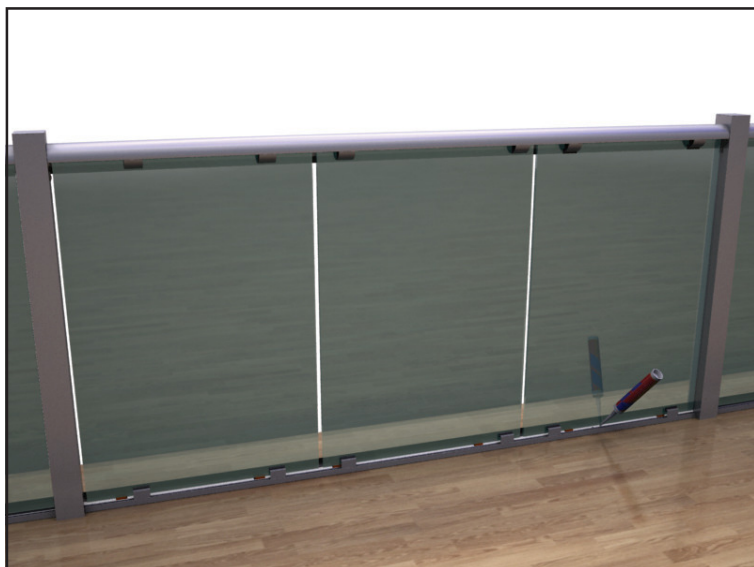

45 Apply a thick bead of high quality silicone sealant to continuously fill the gap between bottom of glass and bottom rail

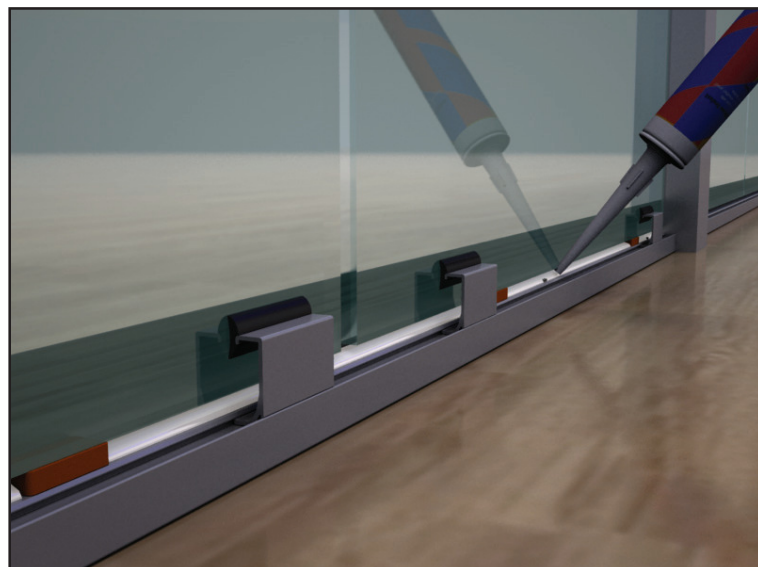

46 Apply a thick bead of high quality silicone sealant to continuously fill the gap between bottom of glass and bottom rail





47 Apply a thick bead of high quality silicone sealant to continuously fill the gap between top of glass and handrail

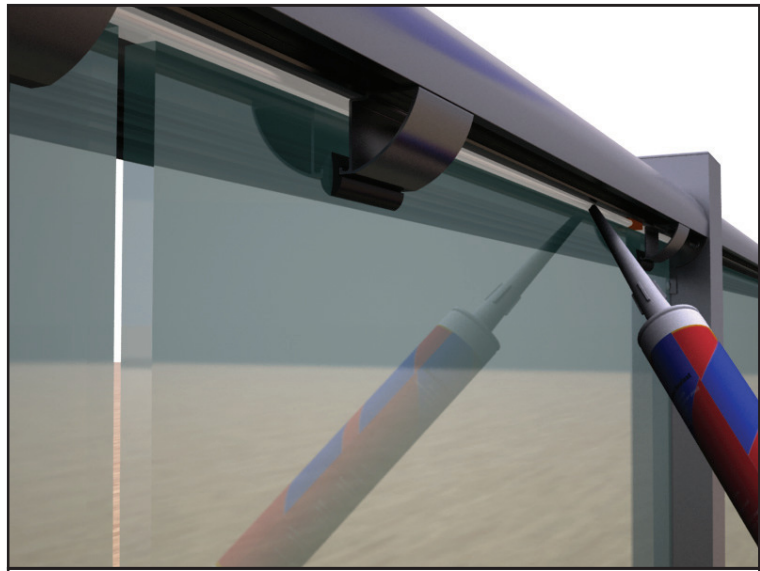

48 Apply a thick bead of high quality silicone sealant to continuously fill the gap between top of glass and handrail



49 Wait until the silicone is completely dry



50 Remove the temporary glazing beads and rubber gaskets



51 Replace the full length glazing bead on the bottom rail



52 Replace the full length glazing bead on the handrail

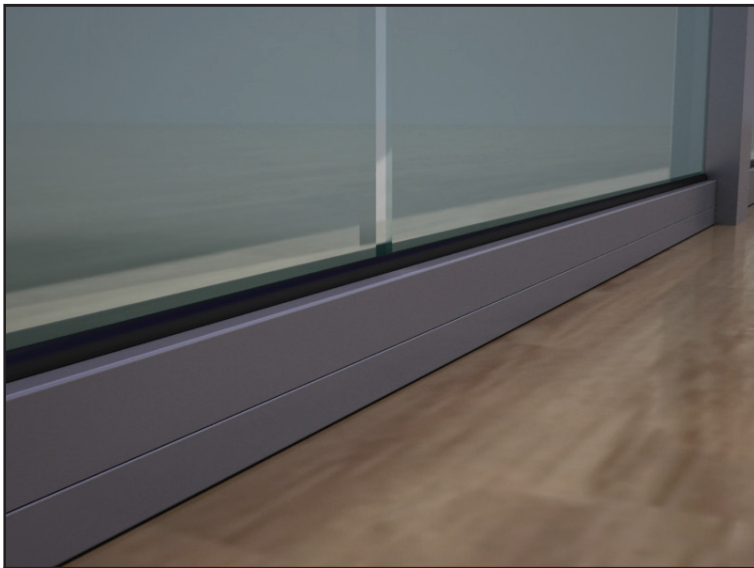

53 Using the 3mm glazing rubber provided glaze the bottom bead against the glass

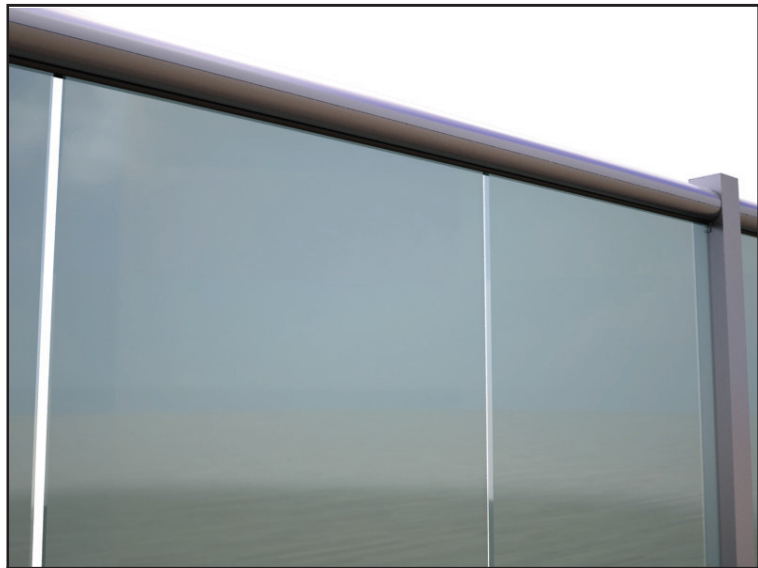

54 Using the 3mm glazing rubber provided glaze the handrail bead against the glass

# Balconette

Balconette 2016  
[www.balconette.co.uk](http://www.balconette.co.uk)

Tel: +44 1342 410411

Fax: +44 1342 410412

Unit 6, Systems House, Eastbourne Road, Blindley Heath,  
Lingfield, Surrey, RH7 6JP, United Kingdom

