

VisioGlide 100 System – W4F Four doors – 2 fixed, 2 sliding



© Balconette 2016

Visio Glide W4-F Curved Sliding Doors

4 doors: 2 fixed, and 2 sliding

Installation guide

1. Insert silicone into the two bottom corners before closing the frame.

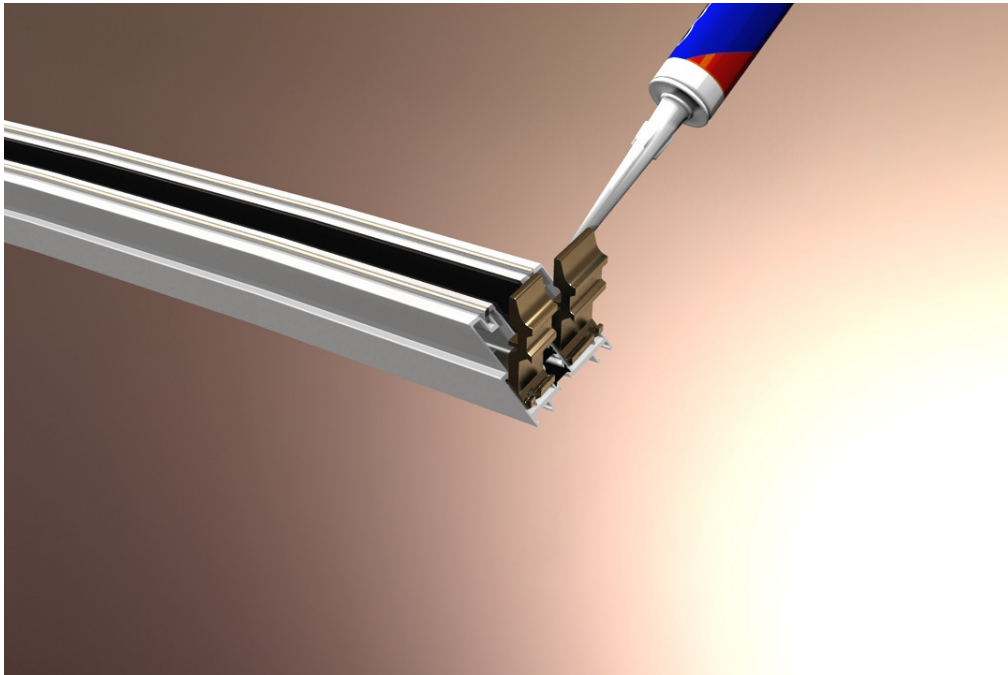

VisioGlide 100 System – W4F Four doors – 2 fixed, 2 sliding

2. Connect top and bottom frame with uprights using the corner angles and allen inserts

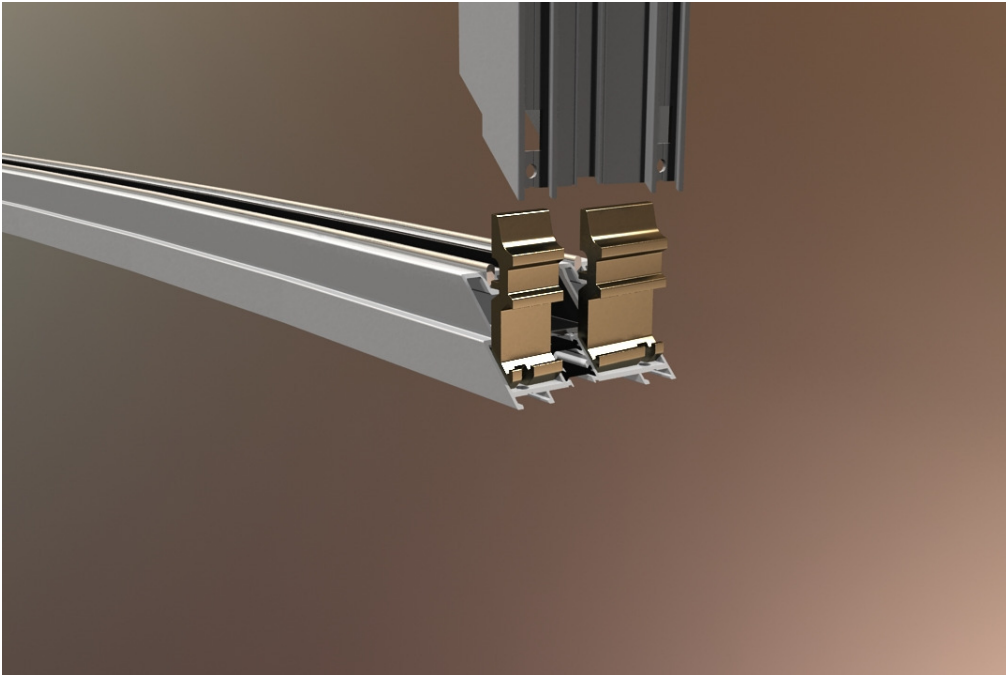

3. Tighten the bolts to close the corner nicely.

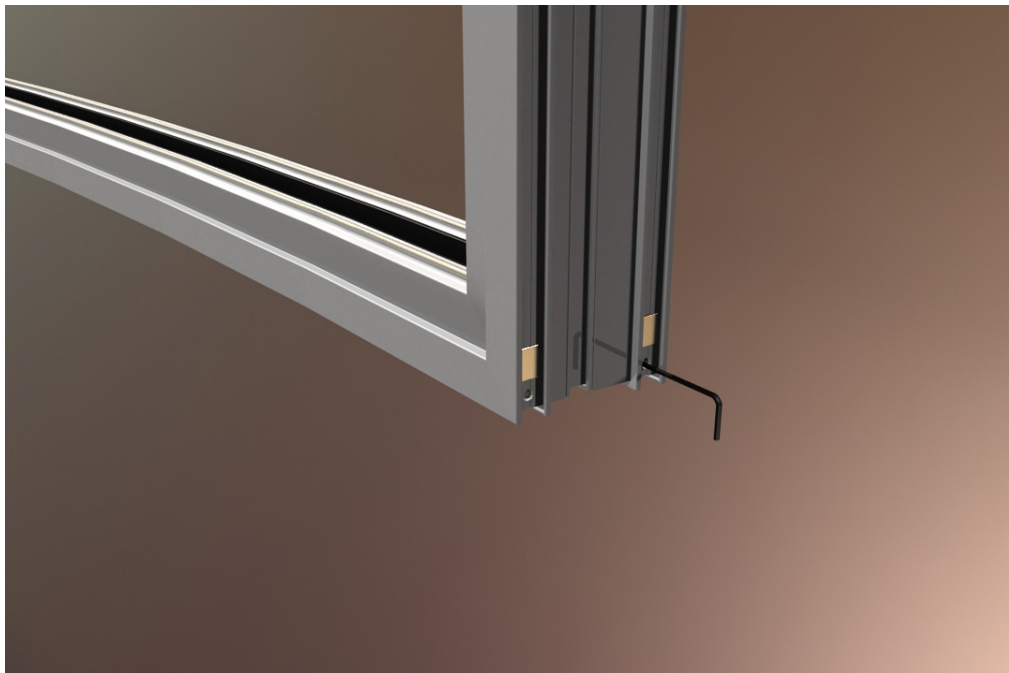

VisioGlide 100 System – W4F Four doors – 2 fixed, 2 sliding

4. You may need to support the top frame with temporary supports so it does not sag until final fix.

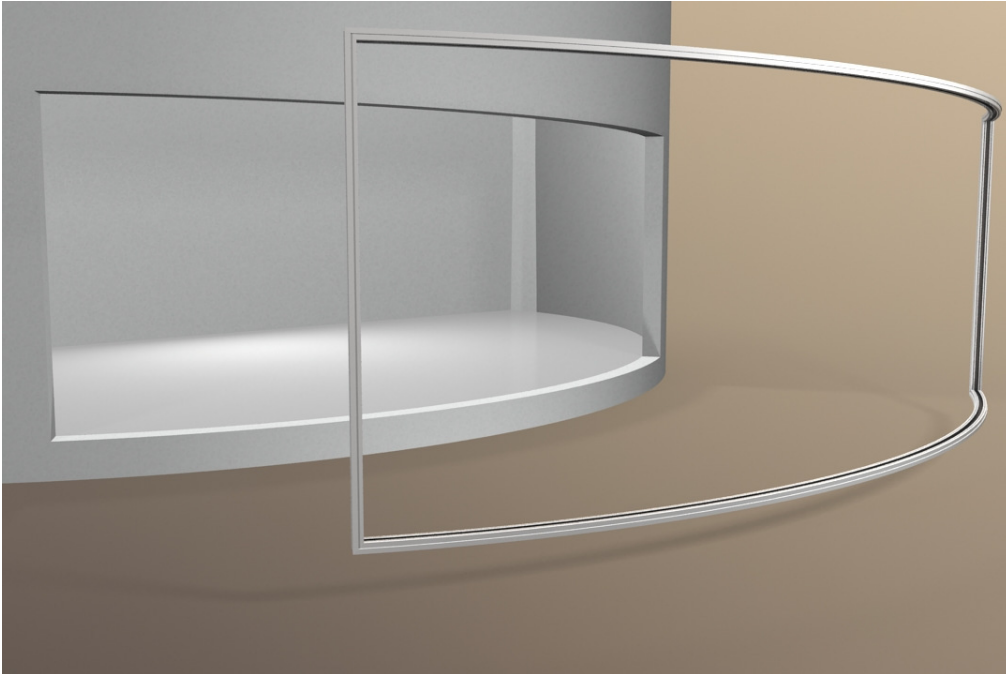

5. Apply a thick bed of silicone sealant where the bottom rail will sit

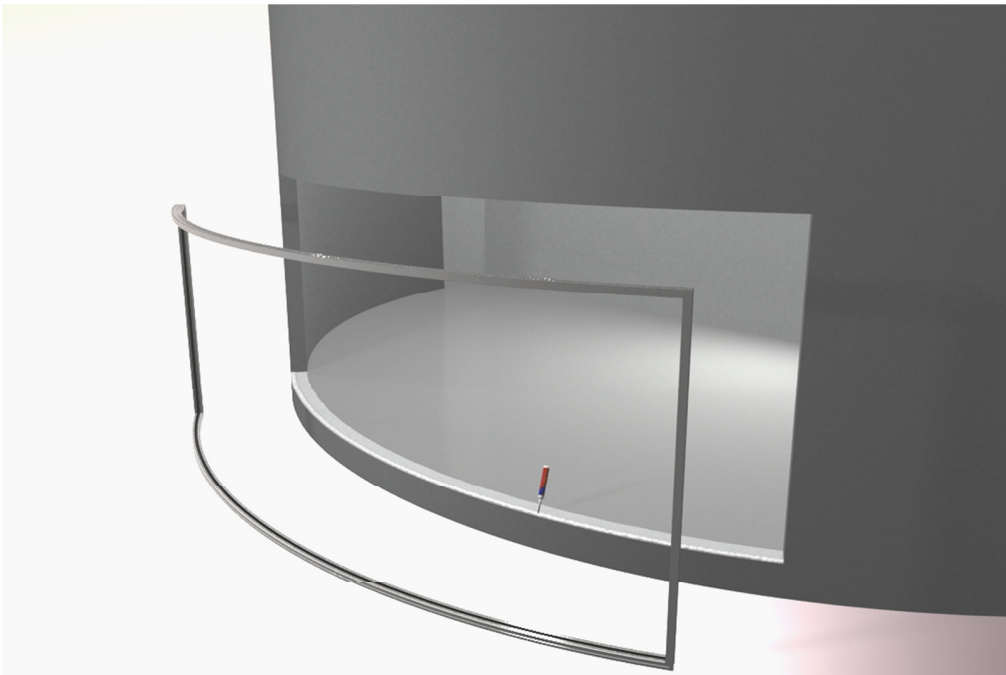

VisioGlide 100 System – W4F Four doors – 2 fixed, 2 sliding

6. Place the frame in the correct position on the opening (remember to bring frame in from outside inward as the outside is longer than the inside).

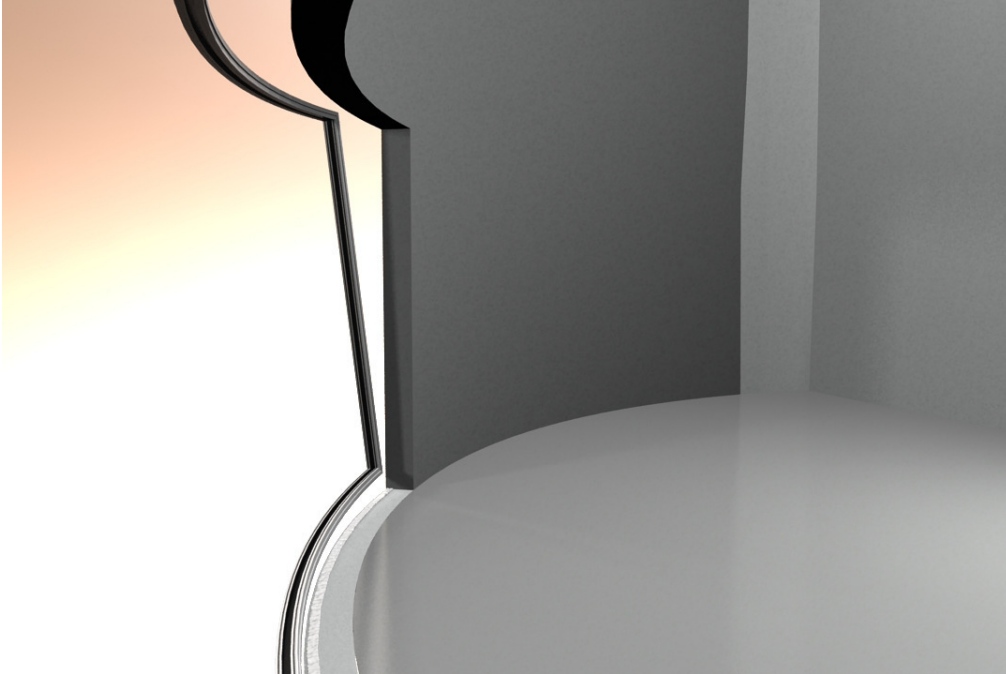

7. Make sure the bottom rail is 100% level

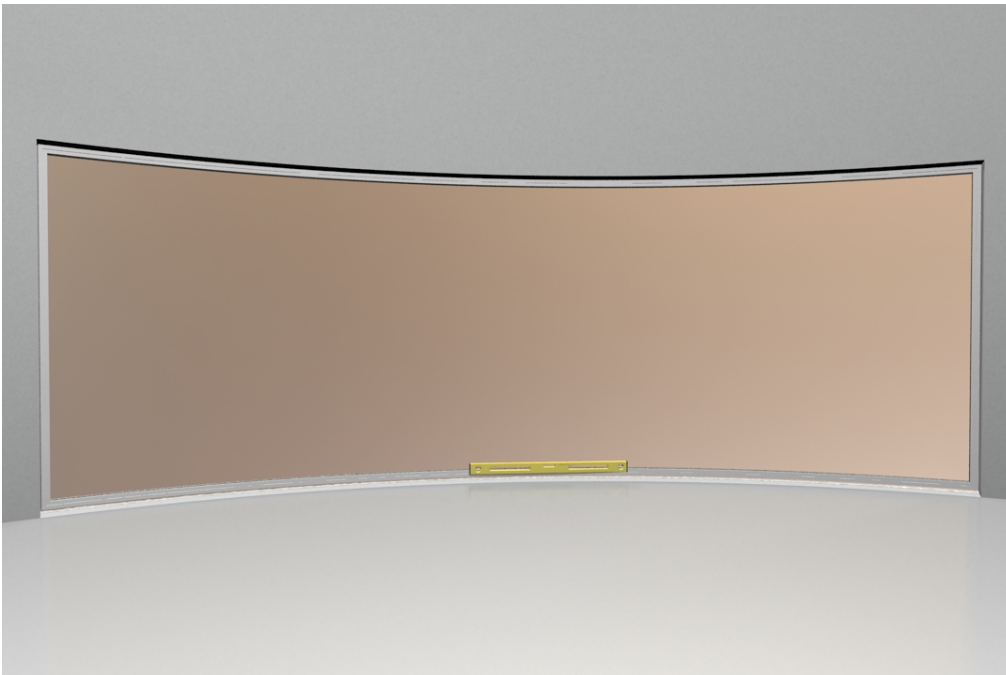

VisioGlide 100 System – W4F Four doors – 2 fixed, 2 sliding

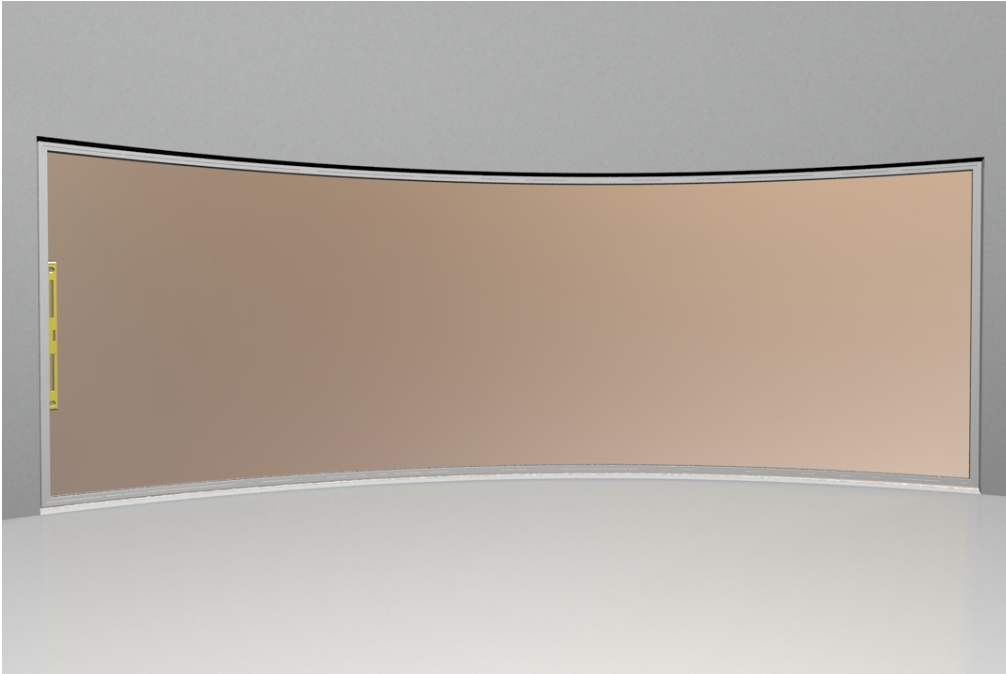

8. Check the heights are level

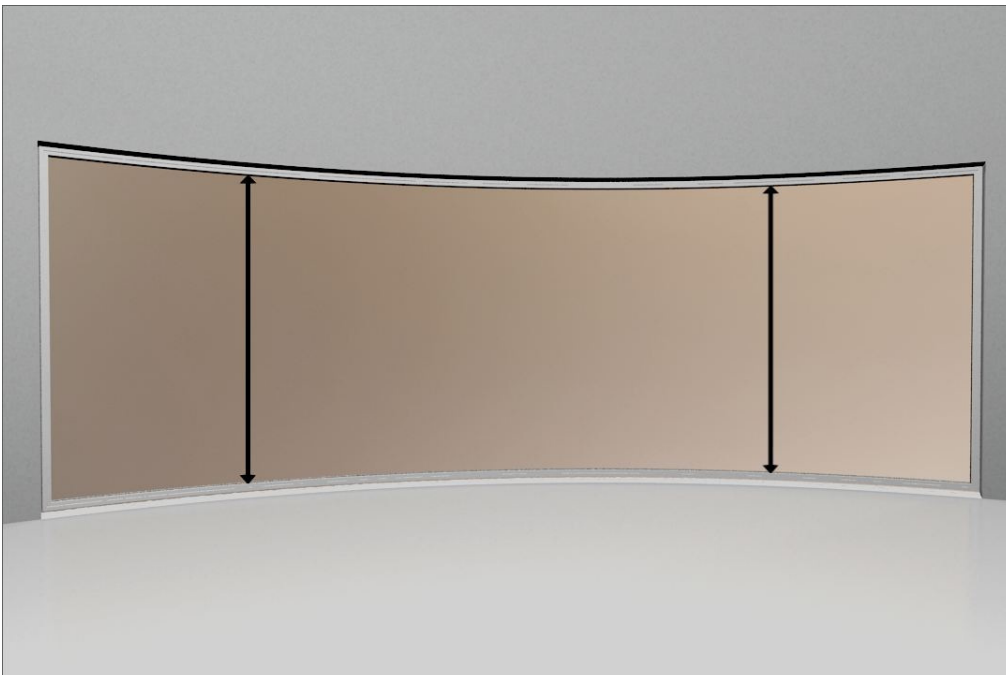

VisioGlide 100 System – W4F Four doors – 2 fixed, 2 sliding

9. Ensure the diagonal measurements are equal from corner to corner both sides

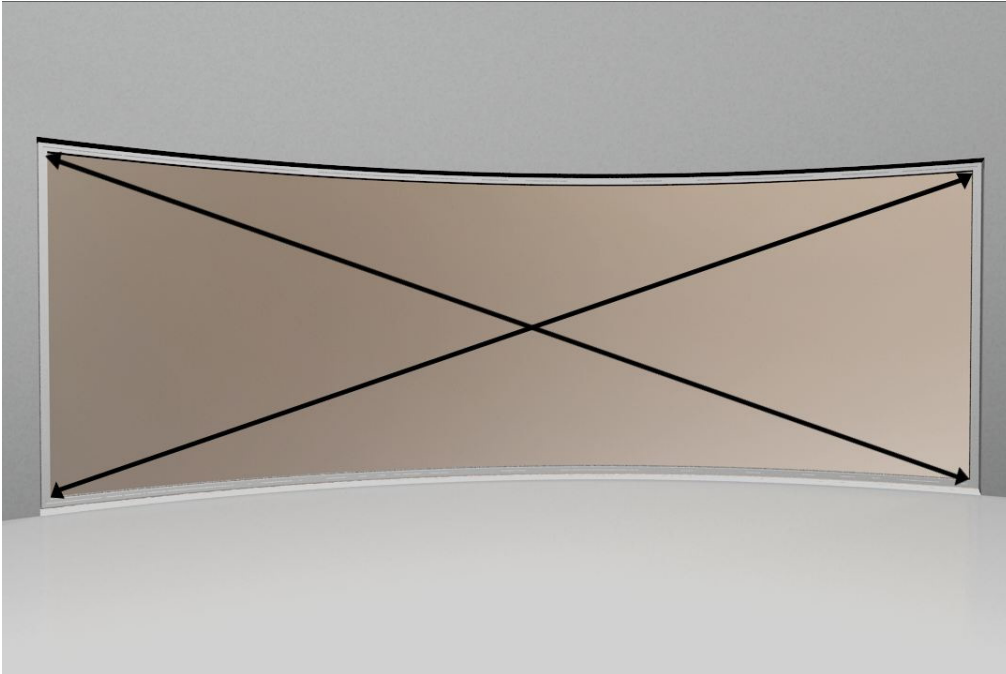

10. Fix the frame level to the opening on the SIDES only at this stage, leaving the top loose. **NEVER** drill the bottom rail! **NEVER** drill or screw through the bottom rail

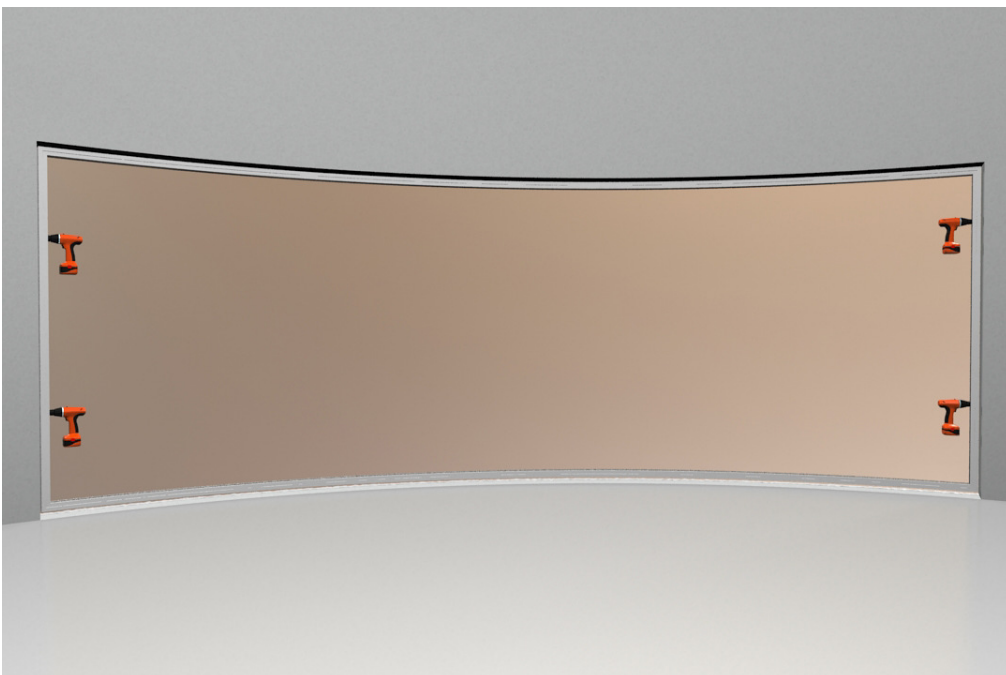

VisioGlide 100 System – W4F Four doors – 2 fixed, 2 sliding

11. Get ready to insert the doors onto the track. Identify the fixed doors and insert them first. When inserting fixed doors make sure they have at least two fixing spacers already fixed to the bottom side. This will line them up height wise to align with the sliding doors.

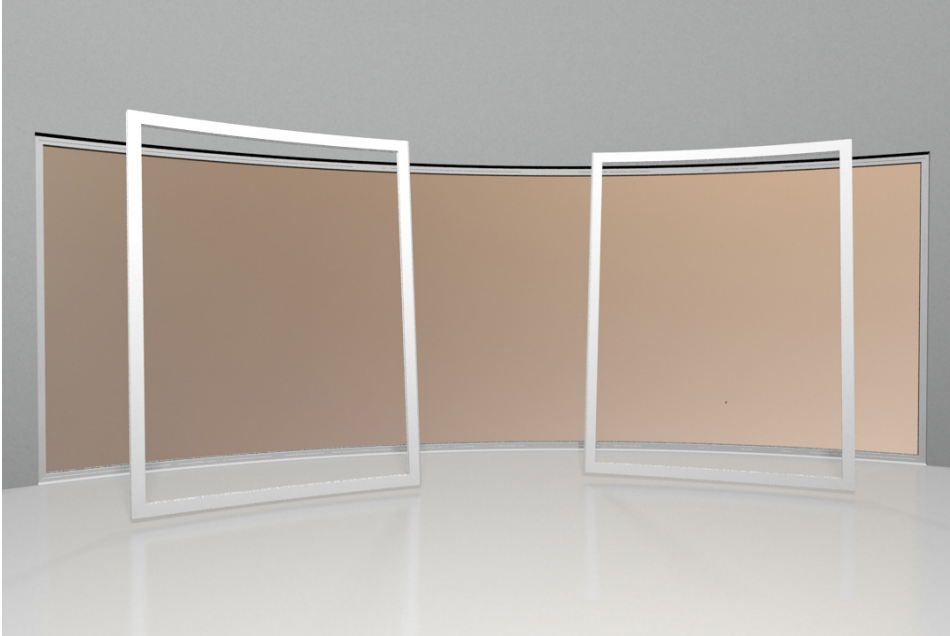

The way to insert doors onto the track is by lifting the door frame as high as possible into the top track, this allows the door to be able to line up above the bottom track and then be lowered onto it. As the top rail is not fixed yet, as you place the doors on the tracks make sure the top rail does not go too high and free from the doors.

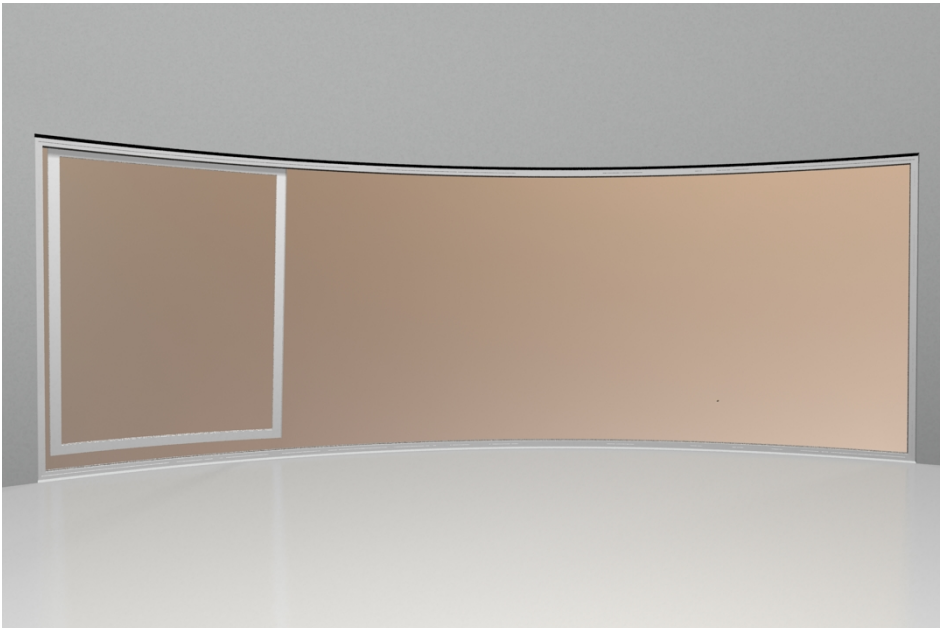

VisioGlide 100 System – W4F Four doors – 2 fixed, 2 sliding

12. Fix the fixed doors in place by drilling in through the fixing spacers to the track. If there are no fixing spacers on the heights, fix these in place first on the height and then fix into the track.

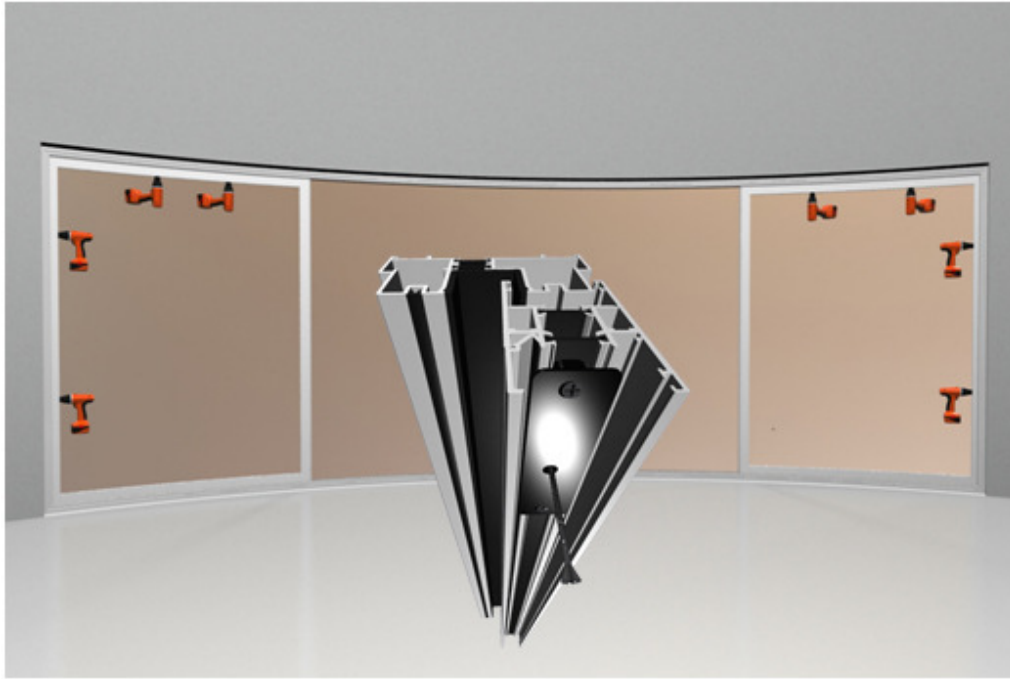

13. Remove the glazing beads from the fixed door frames

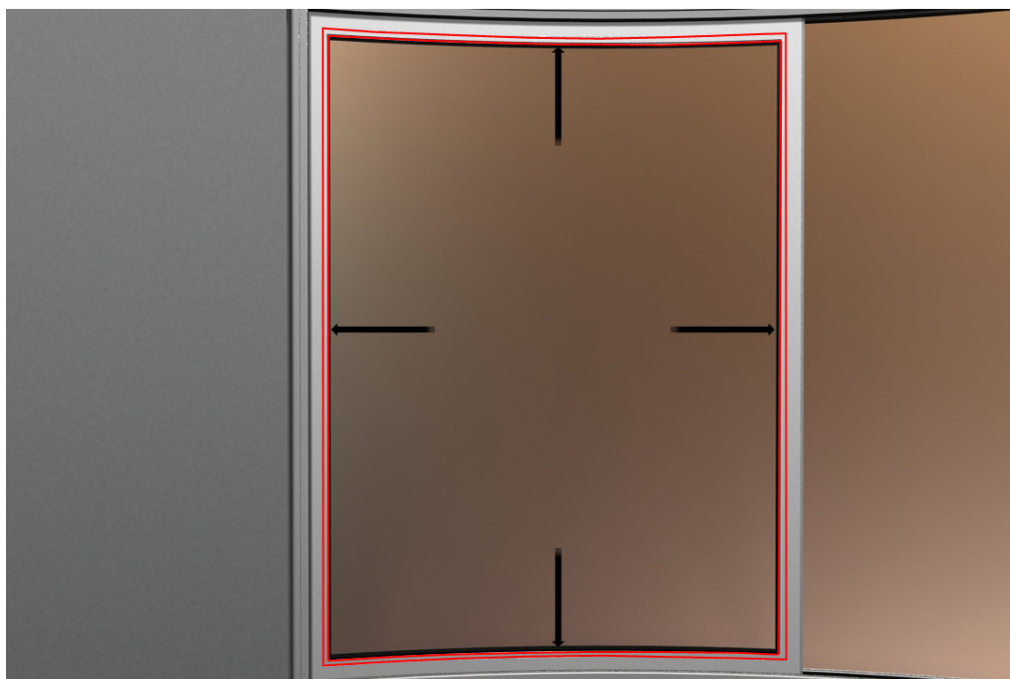

VisioGlide 100 System – W4F Four doors – 2 fixed, 2 sliding

14. Place two glass packers the lower frame in preparation for the glass panel

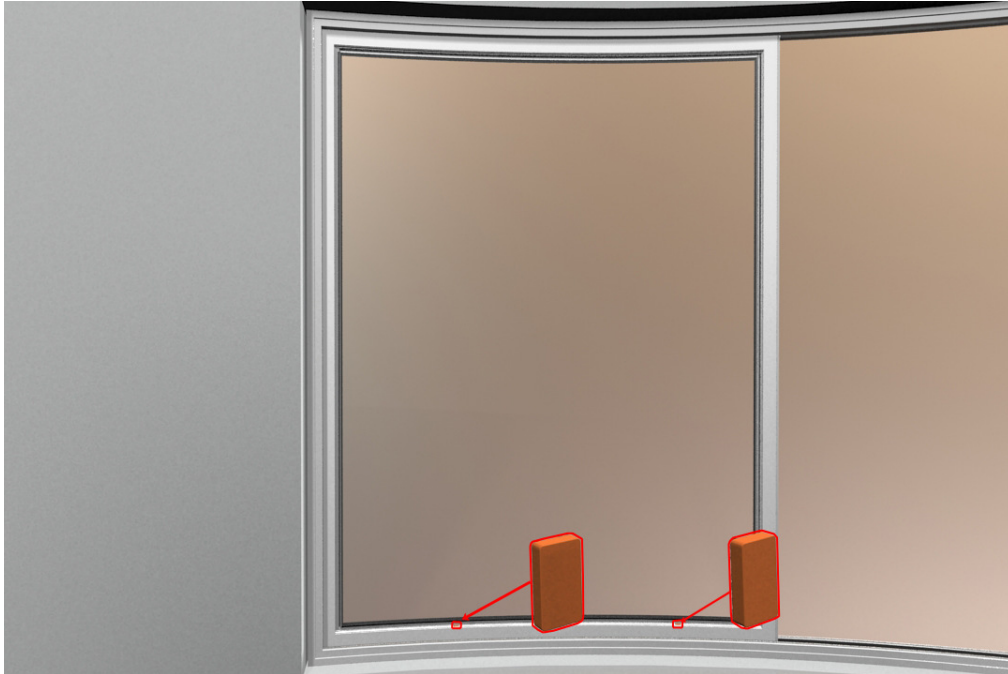

15. Manipulate the fixed glass panel into position inside the fixed frame



VisioGlide 100 System – W4F Four doors – 2 fixed, 2 sliding

16. Replace the top and bottom glazing beads into their place on the fixed door frame to hold the glass in place



17. Position glass packers on the sides of the glass to line the glass up straight and centred

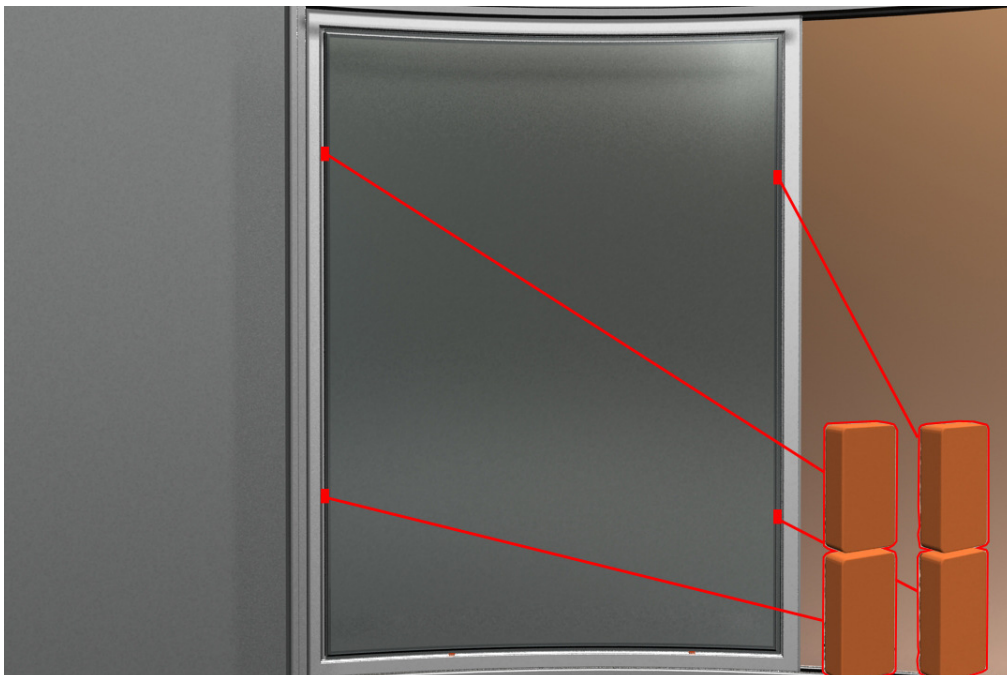

VisioGlide 100 System – W4F Four doors – 2 fixed, 2 sliding

18. Apply a bead of sealant along both sides of the height of the fixed glass panel

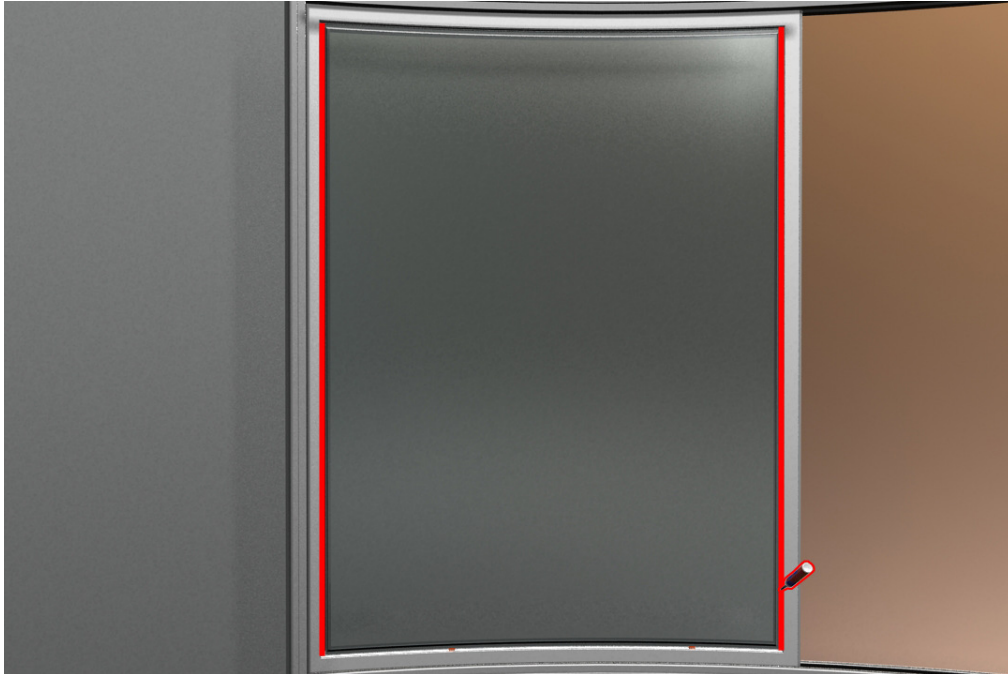

19. Replace the vertical glazing beads into their place on the fixed door frame

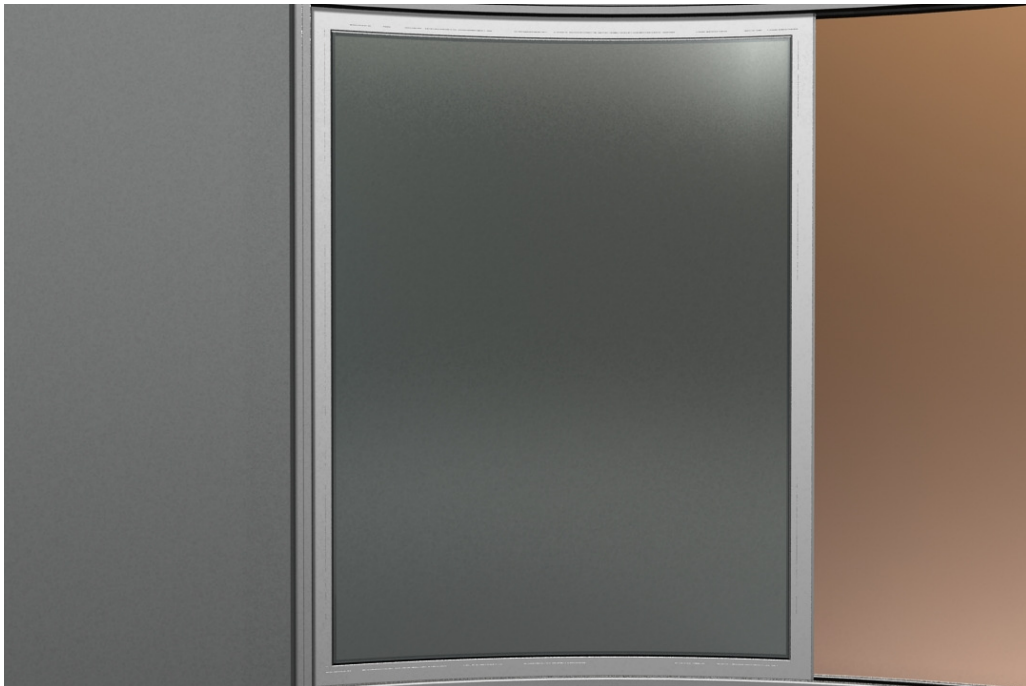

VisioGlide 100 System – W4F Four doors – 2 fixed, 2 sliding

20. Insert the rubber gaskets to secure the glass against the glazing beads

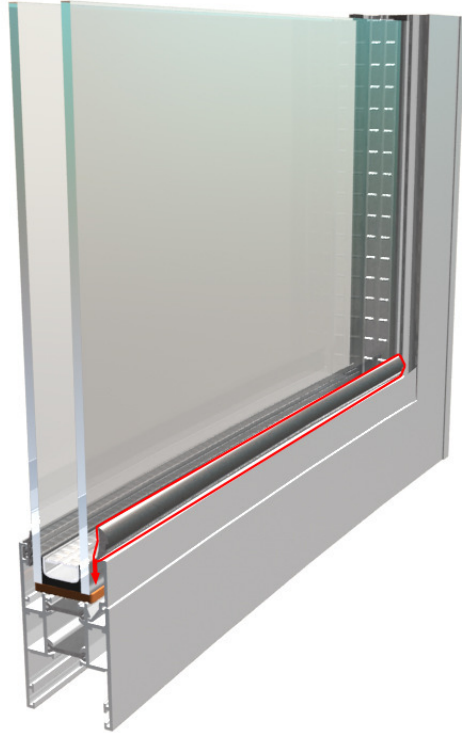

21. Insert the sliding door frames onto the sliding track

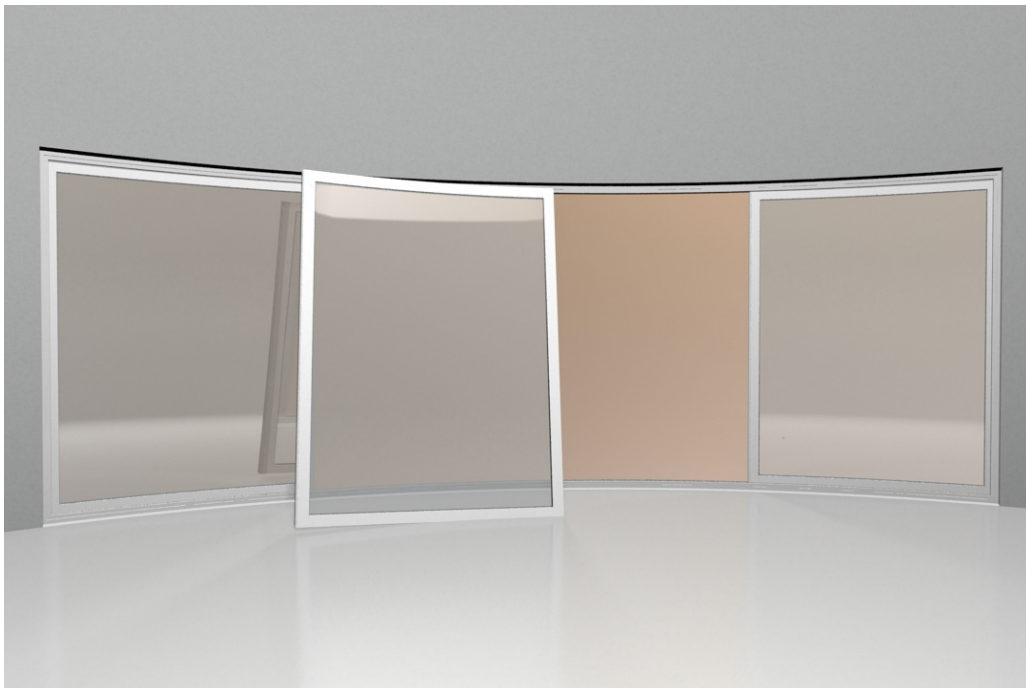

VisioGlide 100 System – W4F Four doors – 2 fixed, 2 sliding

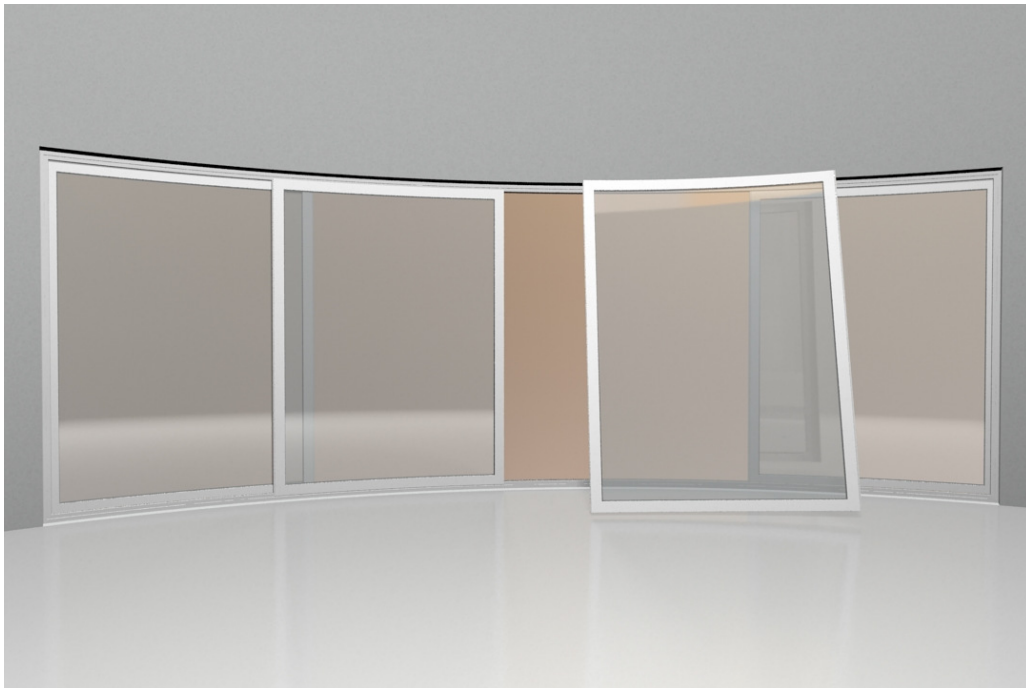

22. Fix the top track in place, in such a manner that it is correctly suspended at an equal height all along the opening and without putting its own weight onto the doors and so it does not apply any load or weight on the sliding doors underneath

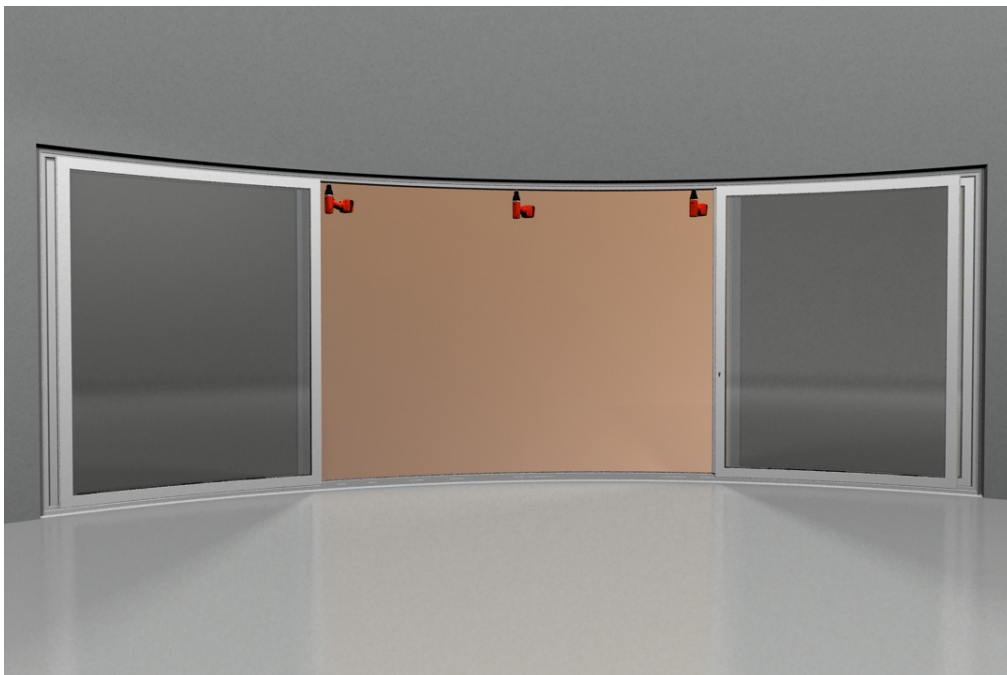

VisioGlide 100 System – W4F Four doors – 2 fixed, 2 sliding

23. Fix the top draught seal directly above interlocks.

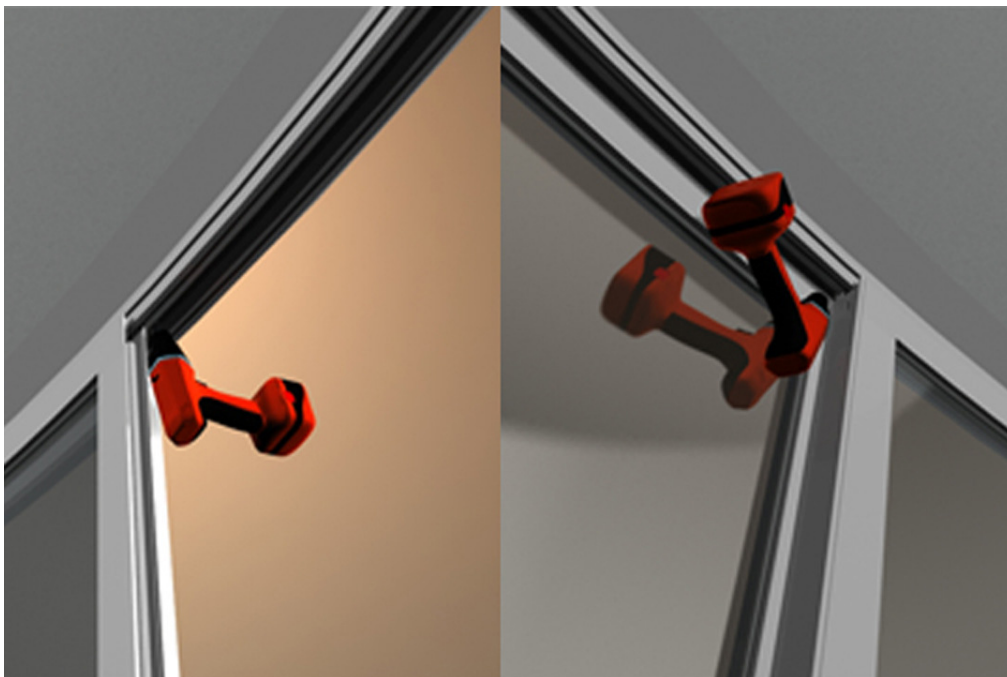
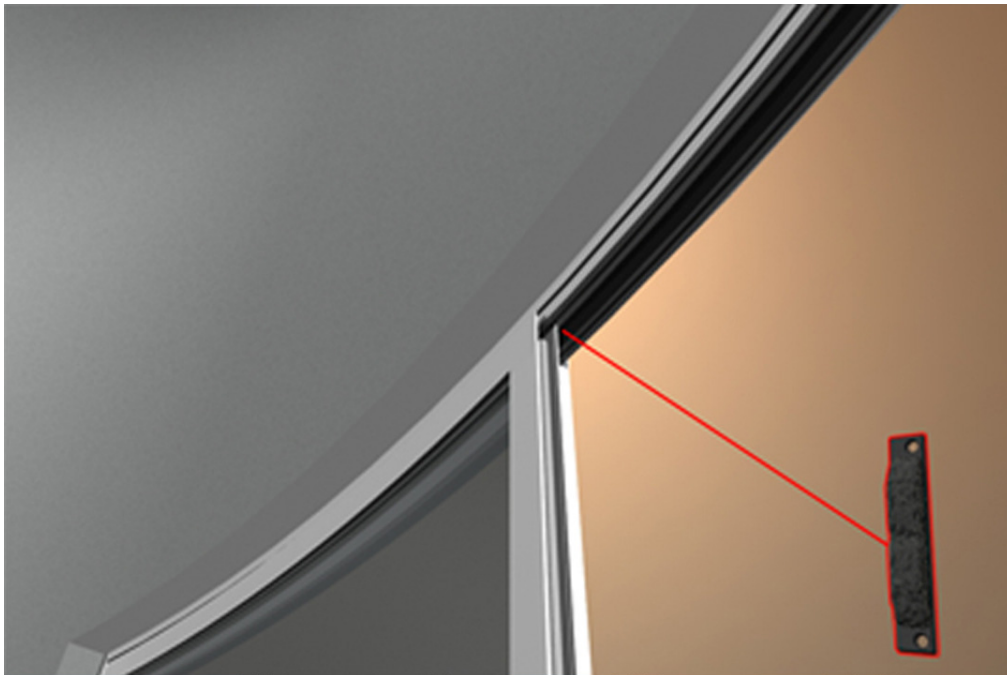

VisioGlide 100 System – W4F Four doors – 2 fixed, 2 sliding

24. Fix the handles to the frame and make sure all doors lock 100%



25. Seal the entire rail with sealant from the inside, so that there is a full bead of sealant along the inside of the frame.

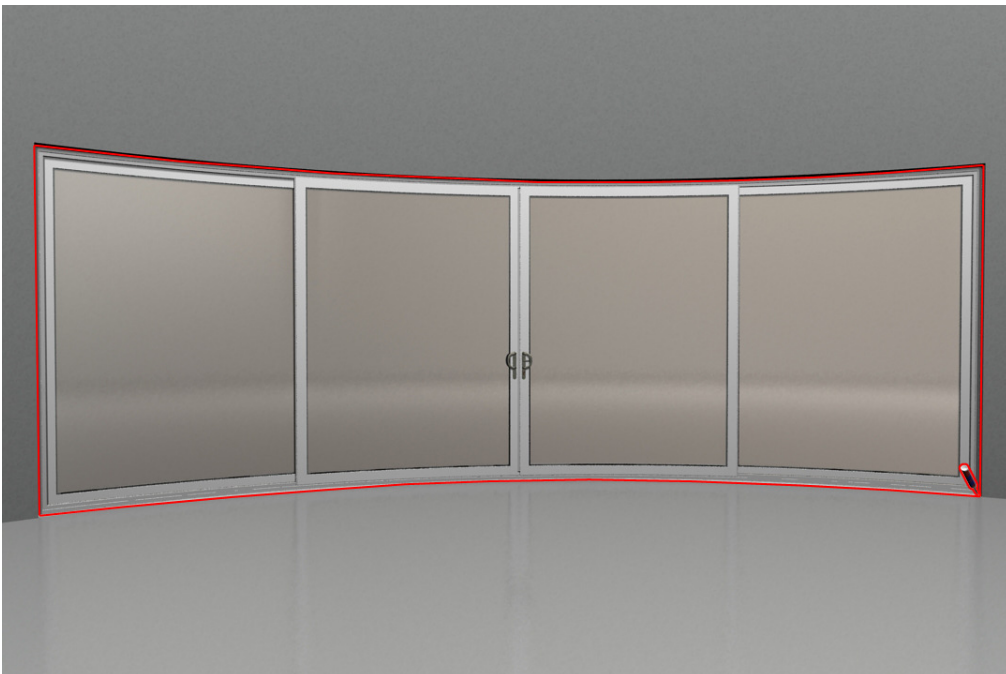

VisioGlide 100 System – W4F Four doors – 2 fixed, 2 sliding

26. Place covers onto all the doors where required.



©Balconette 2016
www.balconette.co.uk

Tel: +44 1342 410411
Fax: +44 1342 410412

Unit 6, Systems House, Eastbourne Road, Blindley Heath, Lingfield, Surrey, RH7 6JP,
United Kingdom