

Balconette

© Balconette 2016

Visio Glide W6-F Curved Sliding Doors

6 doors: 2 fixed, and 4 sliding

Installation guide

1. Prepare to assemble the main frame

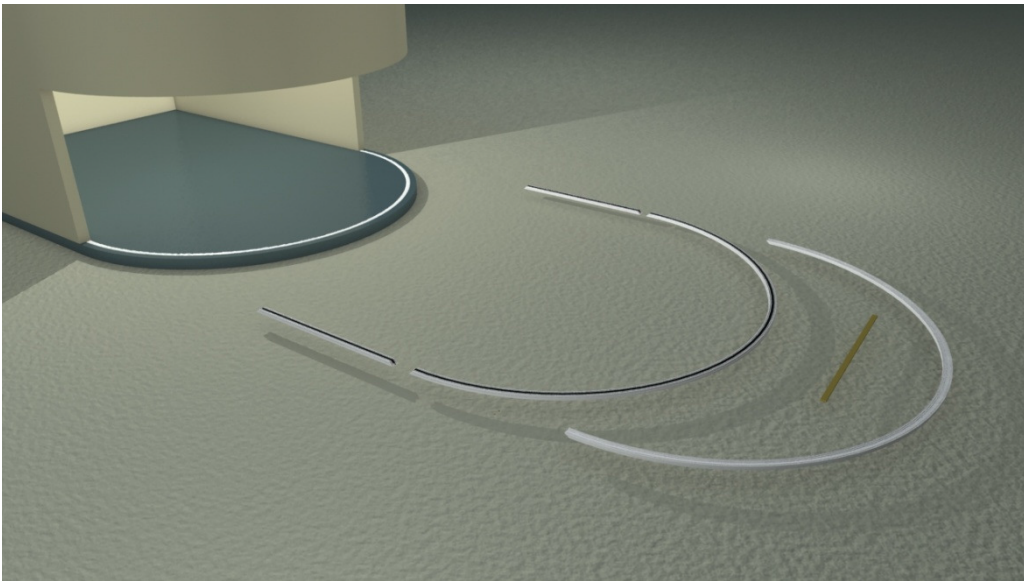

2. Connect the top and bottom frames with the uprights.

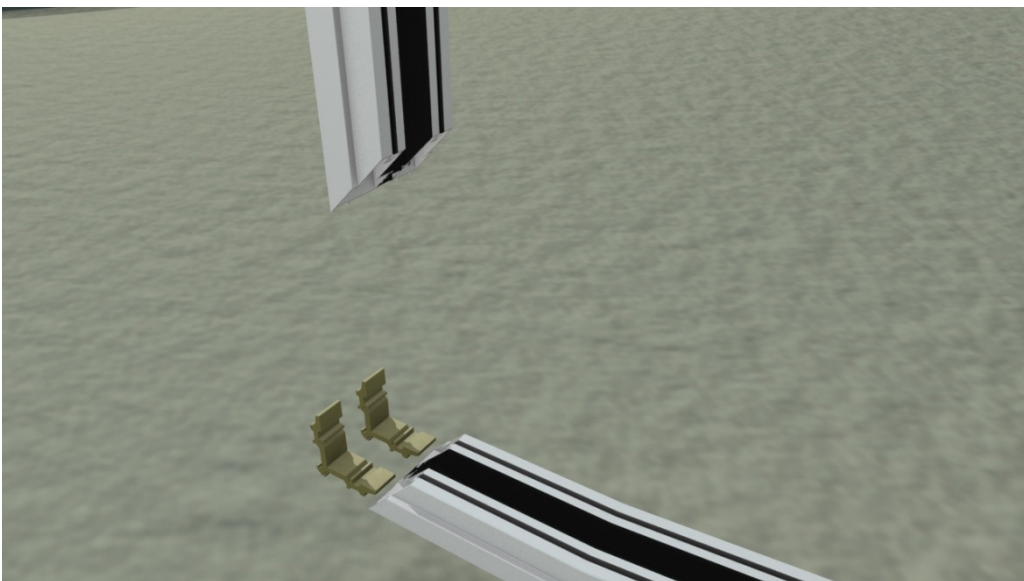

VisioGlide 100 System – W6-F Six doors – 2 fixed, 4 sliding

3. Inject silicone sealant into the two bottom corners



4. Tighten the bolts to close the corner nicely

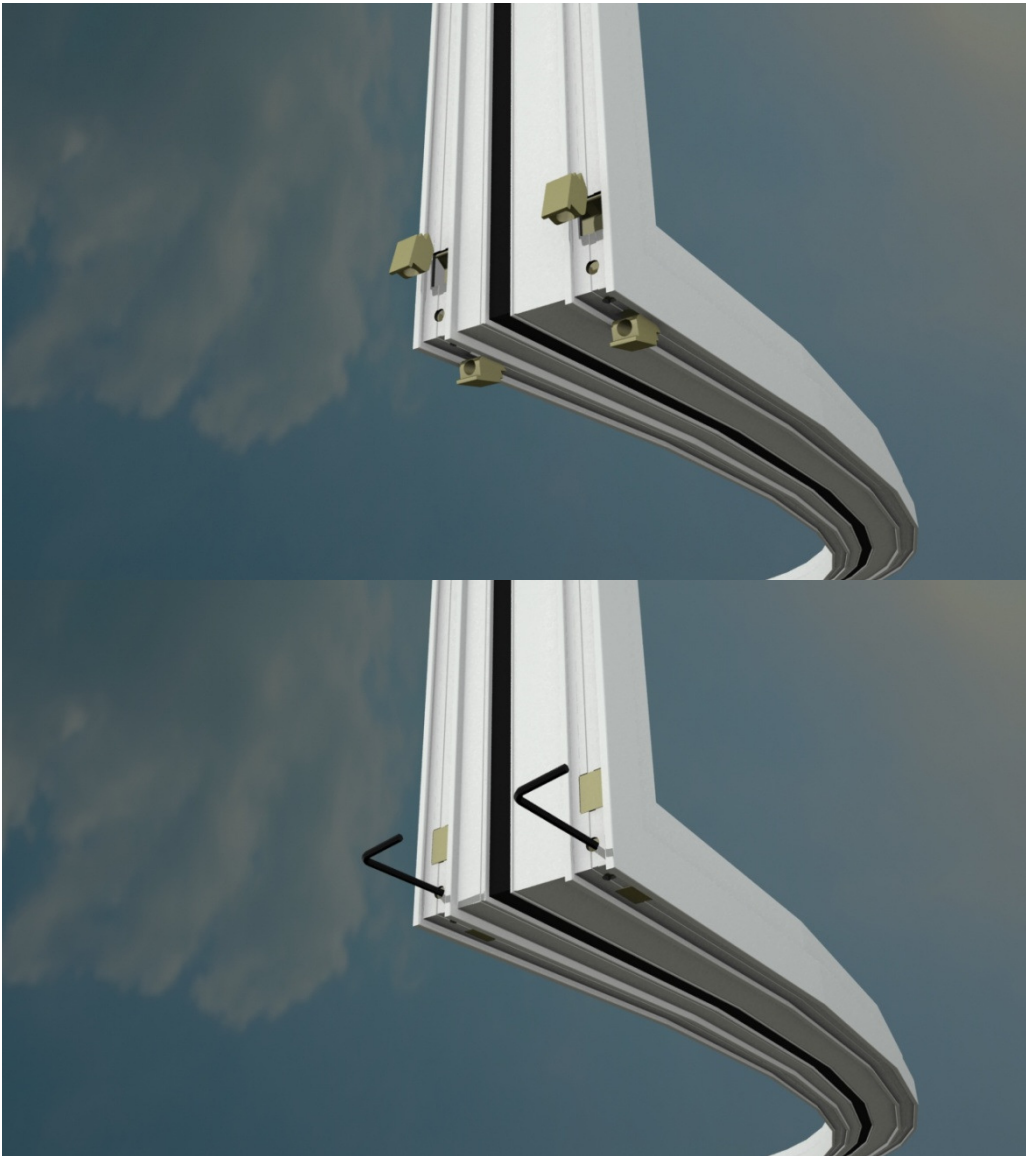

VisioGlide 100 System – W6-F Six doors – 2 fixed, 4 sliding

5. Connect the top and bottom frames with the uprights. Add a timber or other support/s so rail does not sag in the middle

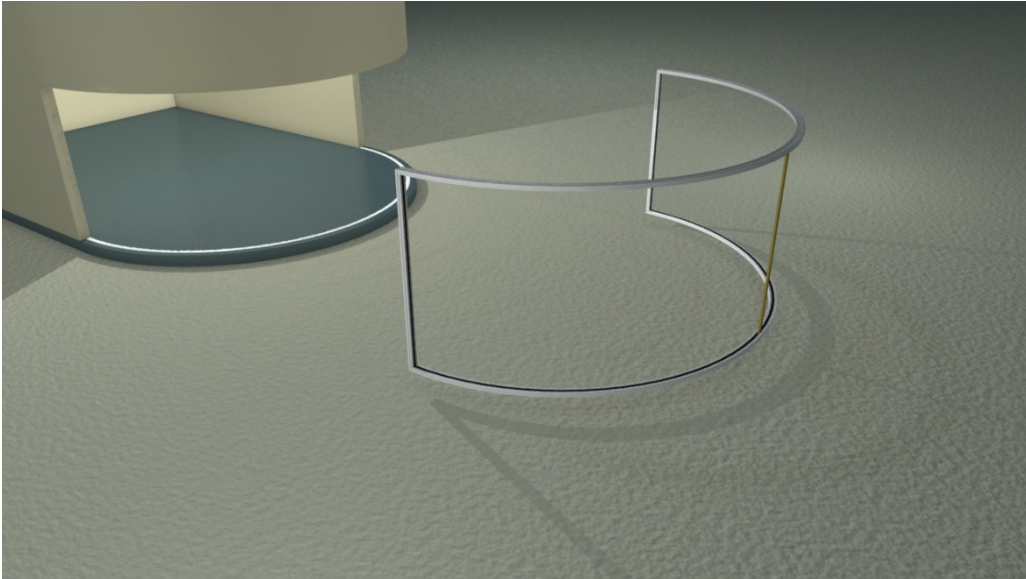

6. Apply a thick bed of silicone sealant where the bottom rail will sit

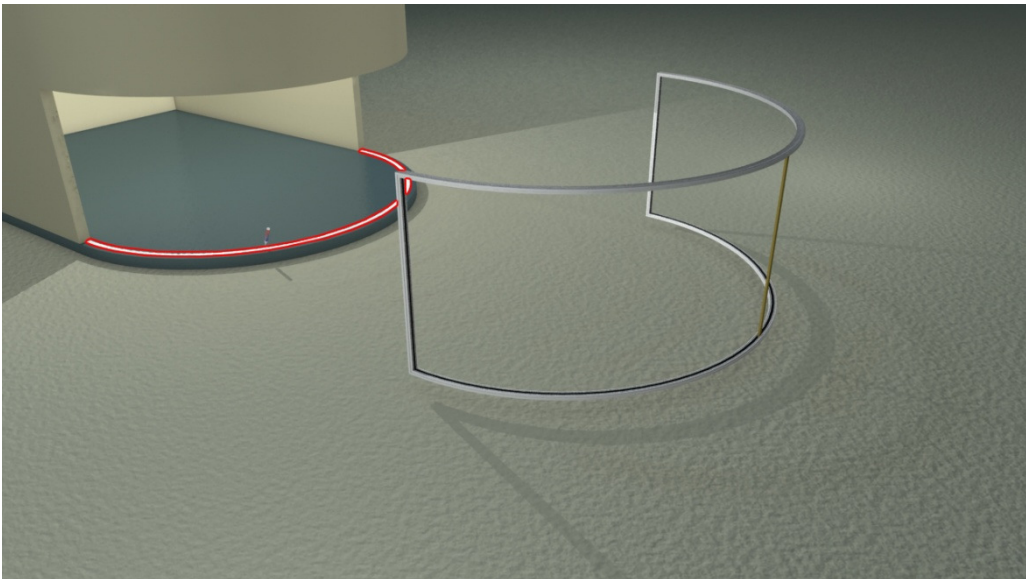

VisioGlide 100 System – W6-F Six doors – 2 fixed, 4 sliding

7. Bringing the frame in from the outside, position the frame in the correct position on the opening

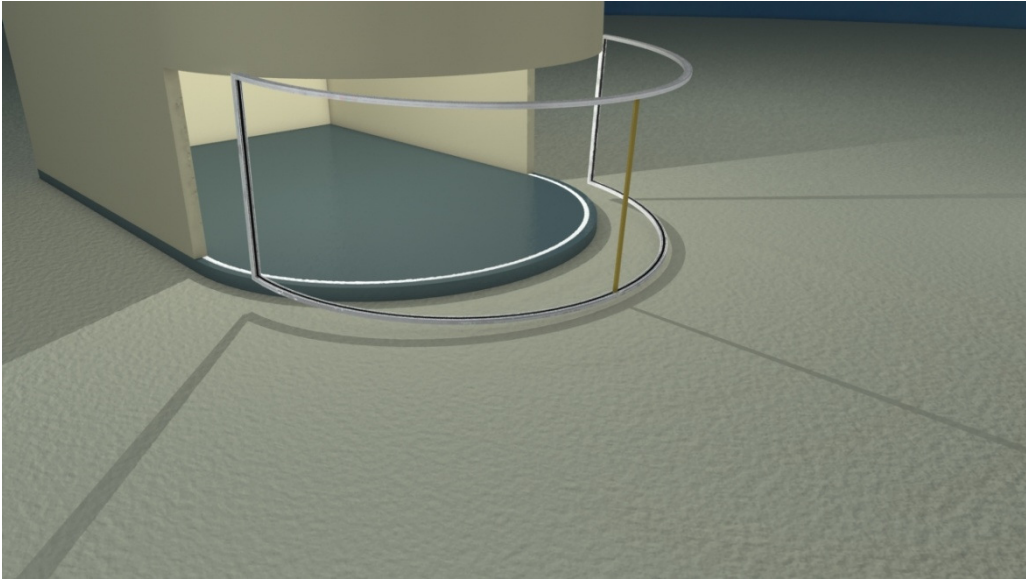

8. Make sure the bottom rail is 100% level all along

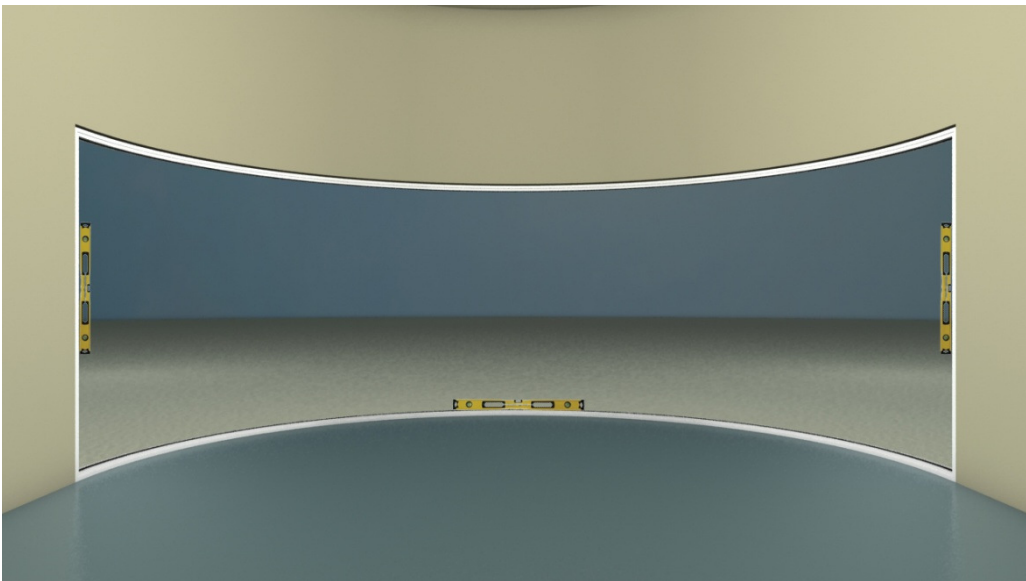

VisioGlide 100 System – W6-F Six doors – 2 fixed, 4 sliding

9. Check the heights are level

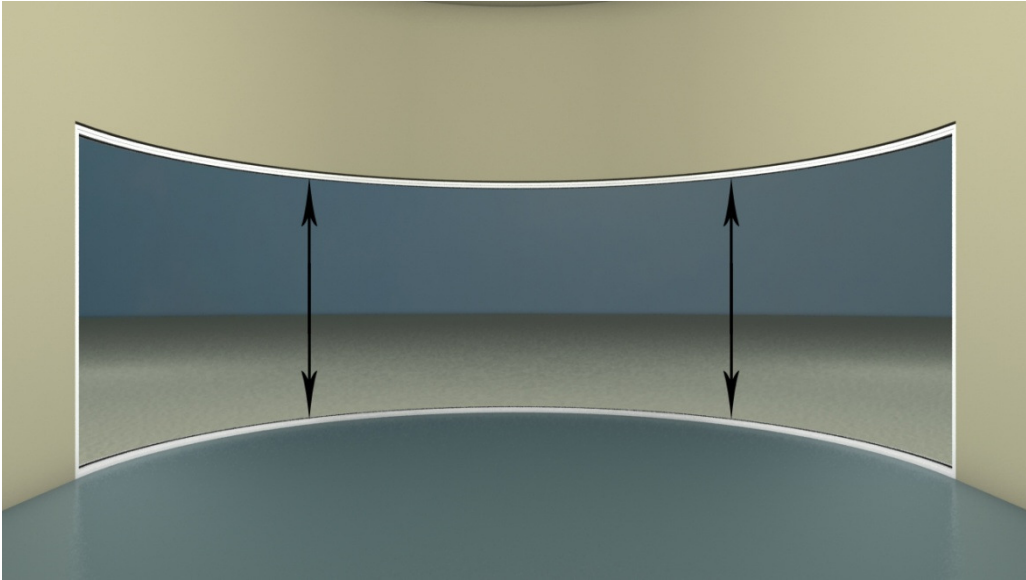

10. Ensure the diagonal measurements are equal from corner to corner both sides.

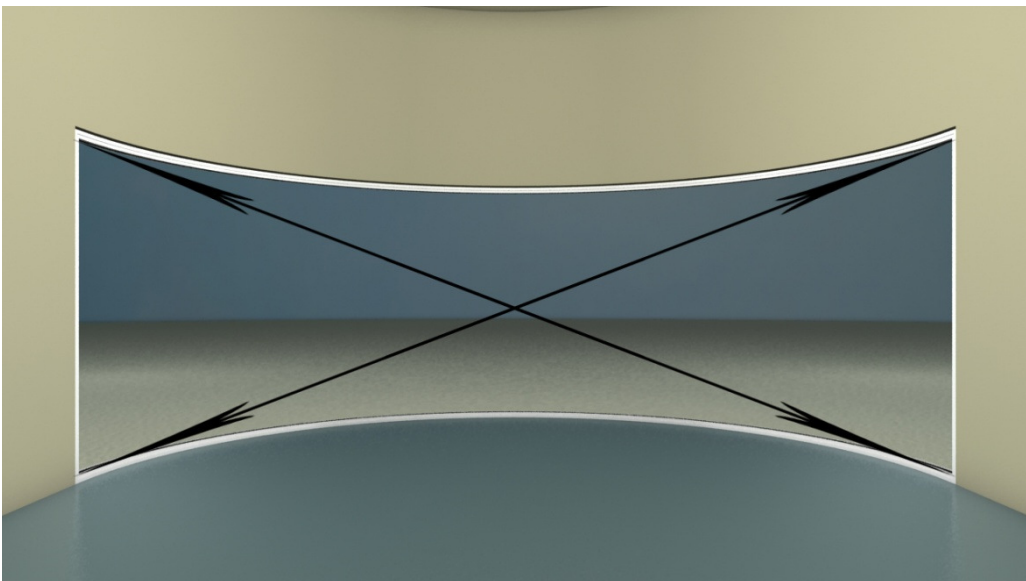

VisioGlide 100 System – W6-F Six doors – 2 fixed, 4 sliding

11. Fix the frame to the opening on the VERTICAL SIDES ONLY at this stage
Note: never screw through the bottom rail

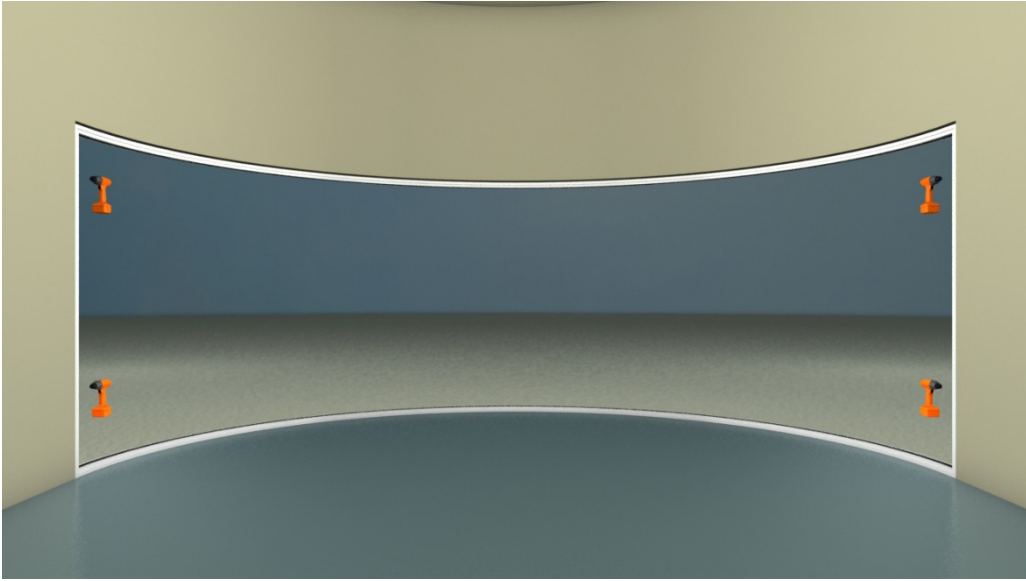

12. Position the external fixed frame to its correct position

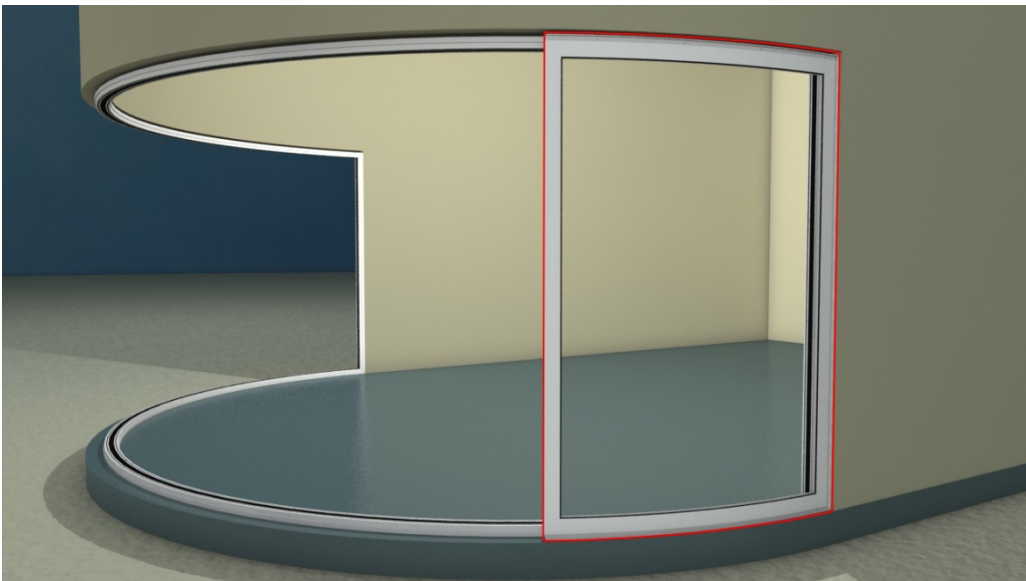

VisioGlide 100 System – W6-F Six doors – 2 fixed, 4 sliding

13. Screw through the fixed frame to connect it to main frame

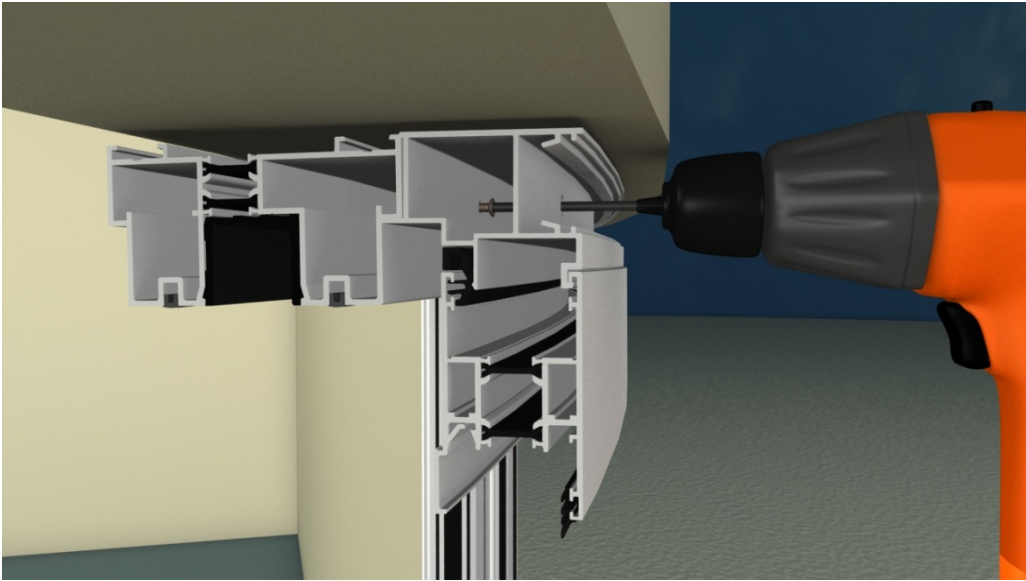

14. Replace the cover to hide the screws

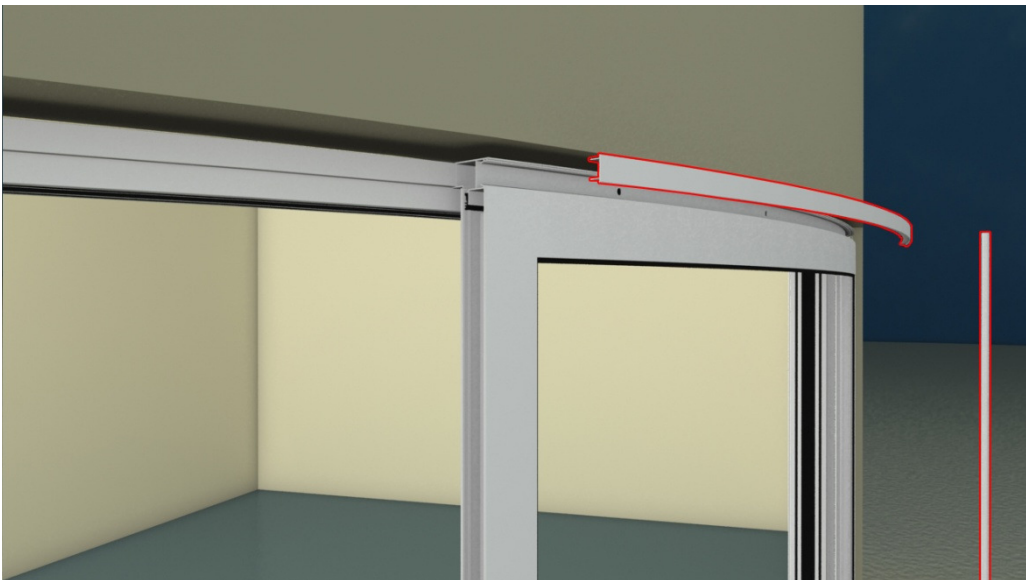

VisioGlide 100 System – W6-F Six doors – 2 fixed, 4 sliding

15. Fix the interlock profile to the side of the fixed door

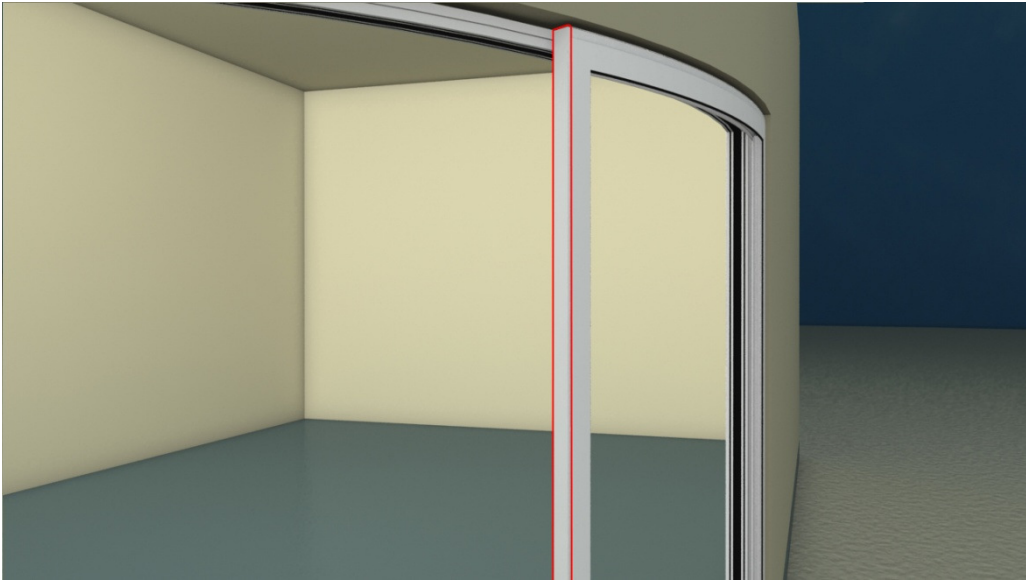

16. Remove the glazing beads from the fixed door frames

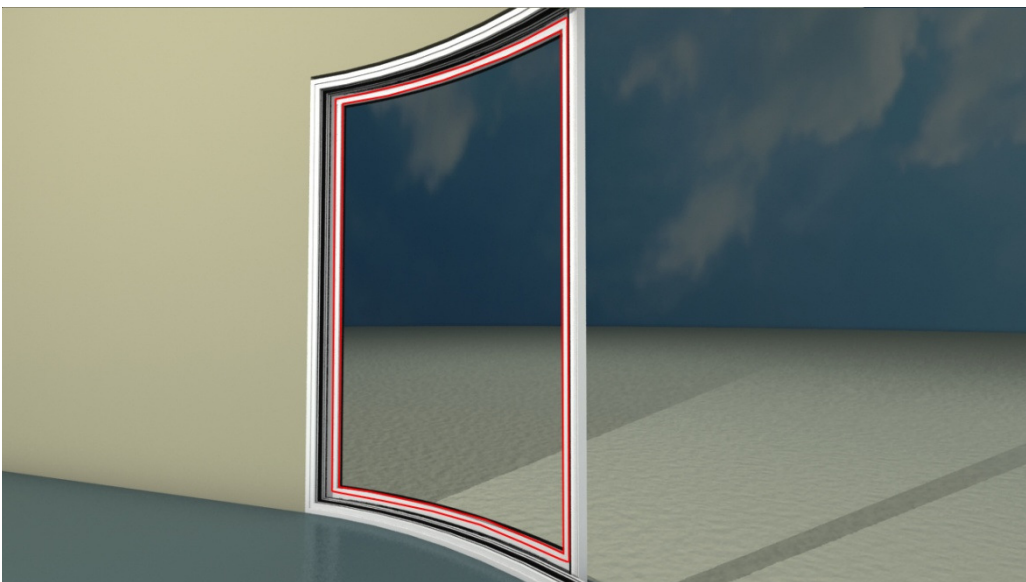

VisioGlide 100 System – W6-F Six doors – 2 fixed, 4 sliding

17. Place two glass packers the lower part of the door frame

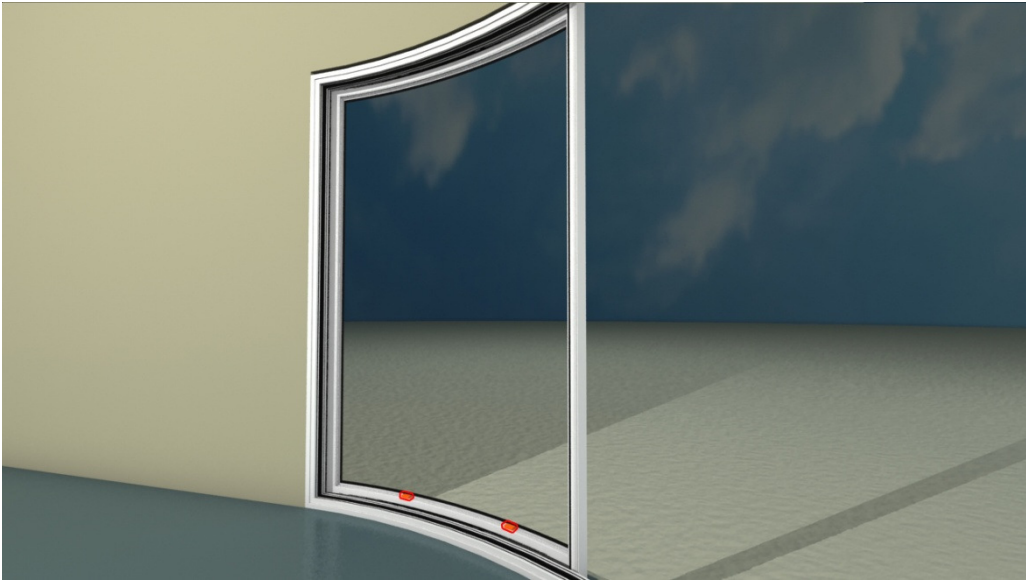

18. Manipulate the fixed glass panel into position inside the fixed door frame

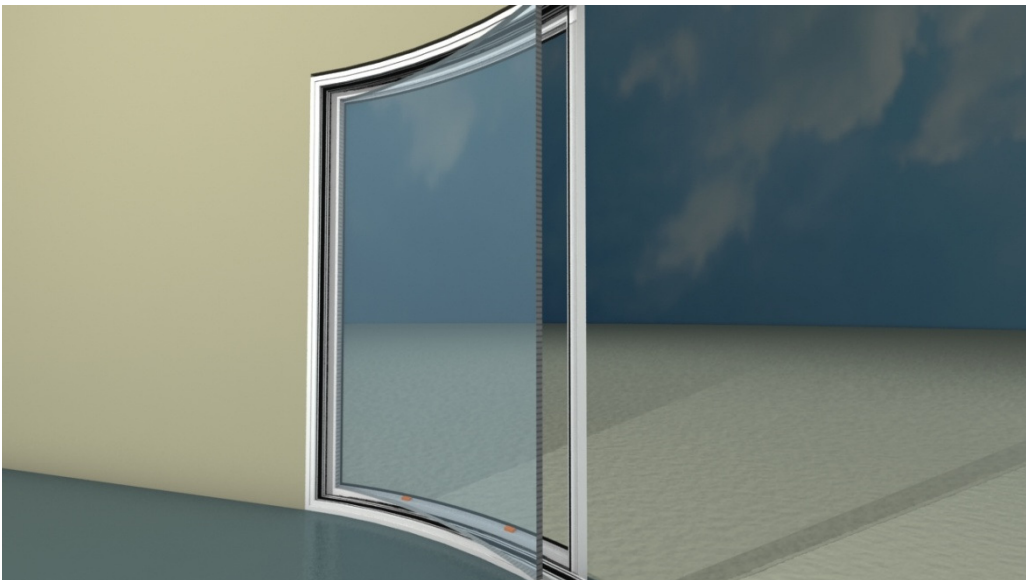

VisioGlide 100 System – W6-F Six doors – 2 fixed, 4 sliding

19. Replace the top and bottom curved glazing beads

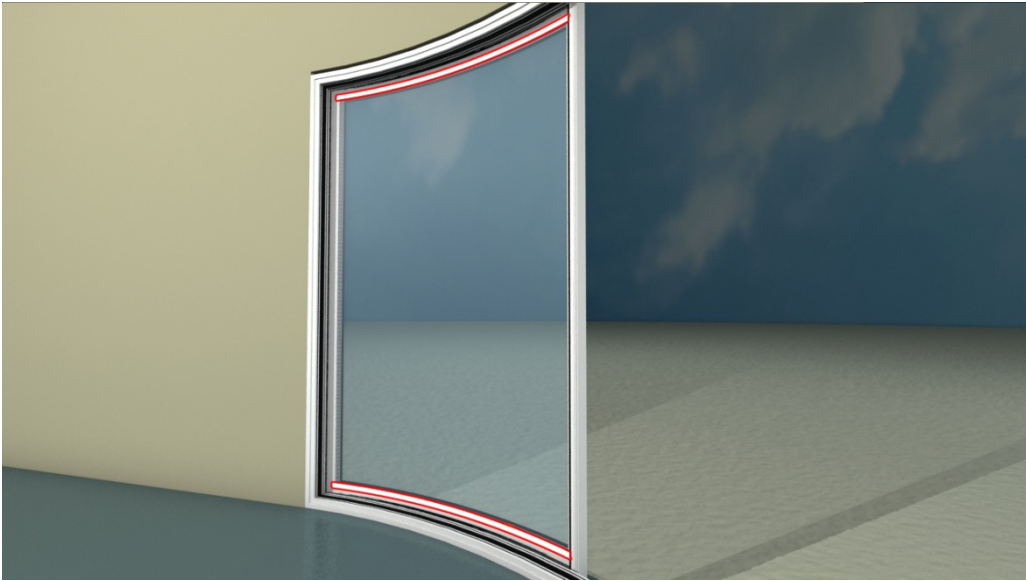

20. Position glass packers on the side of the glass

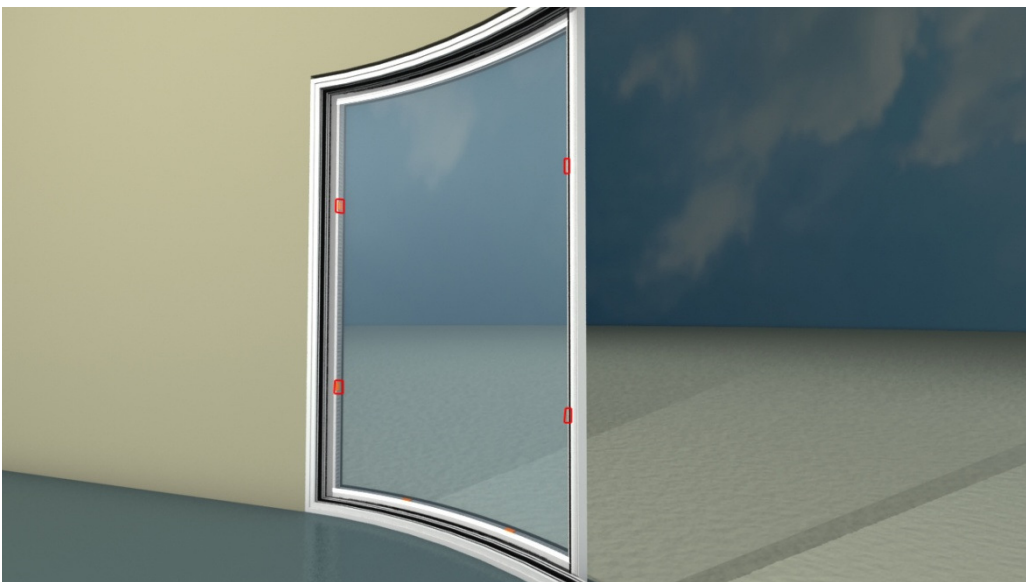

VisioGlide 100 System – W6-F Six doors – 2 fixed, 4 sliding

21. Inject a bead of sealant along both sides of the height of the fixed glass panel

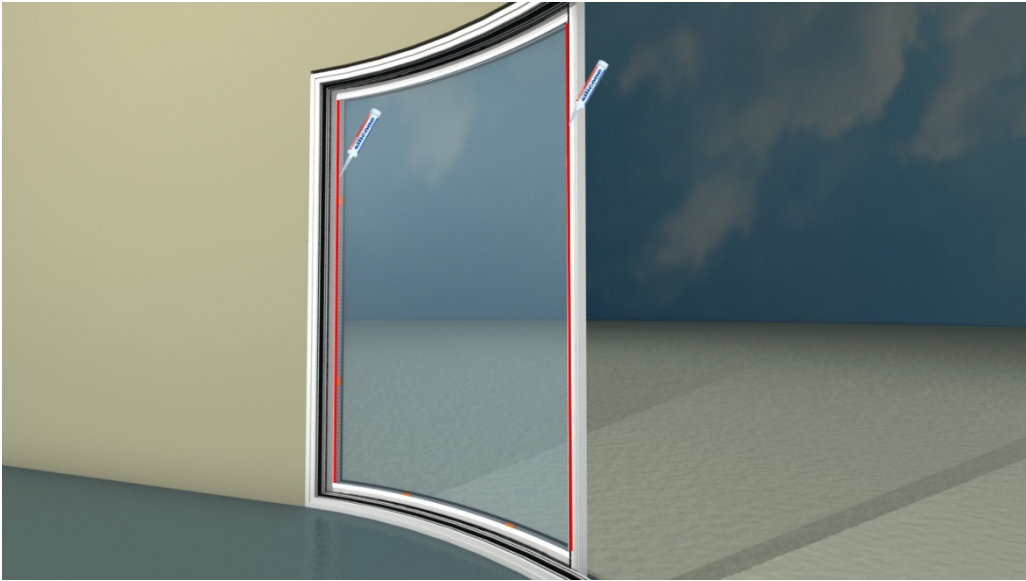

22. Replace the vertical glazing beads

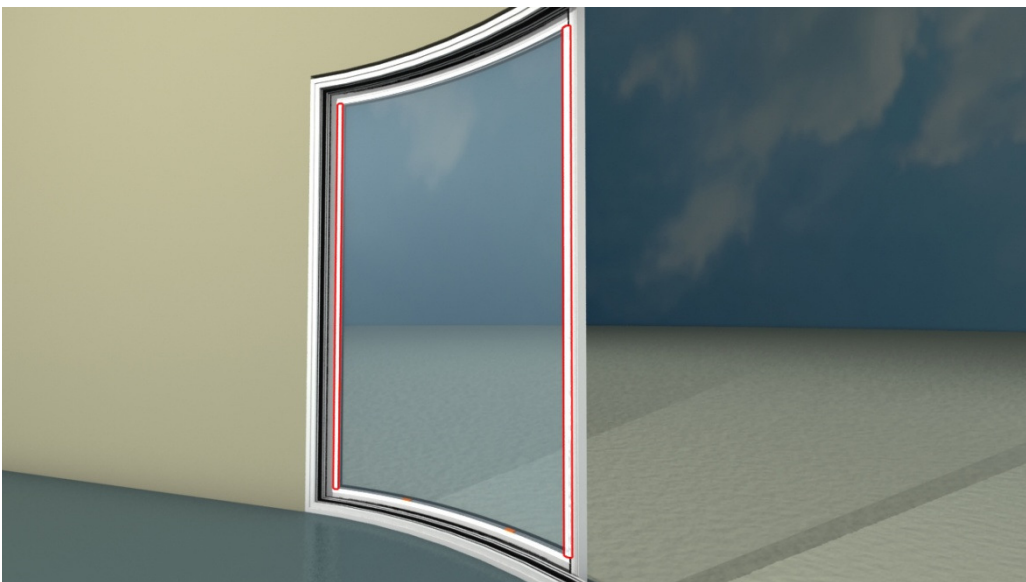

VisioGlide 100 System – W6-F Six doors – 2 fixed, 4 sliding

23. Insert the rubber gaskets to secure the glass against the glazing beads

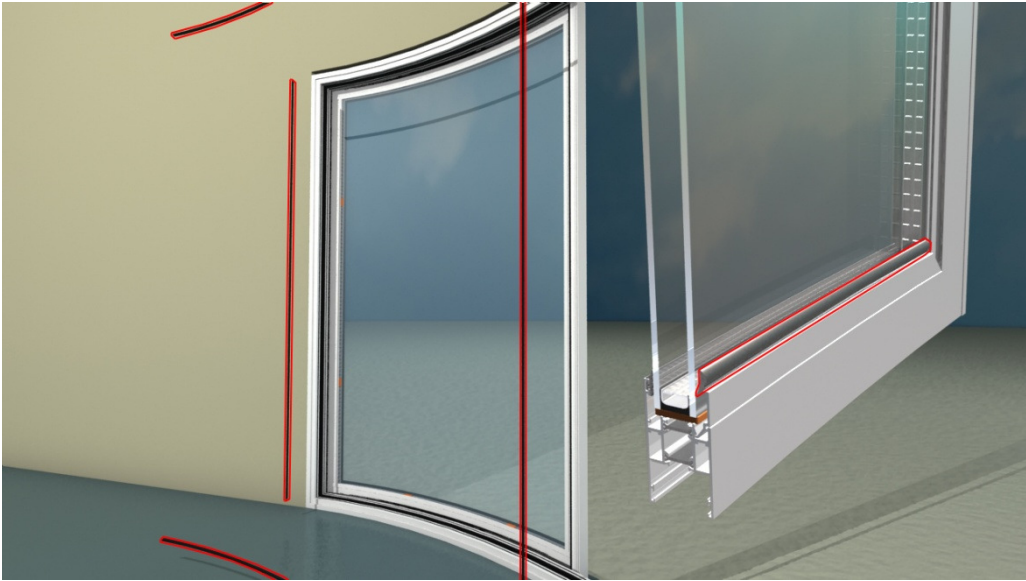

24. Insert the sliding door frames onto the sliding tracks

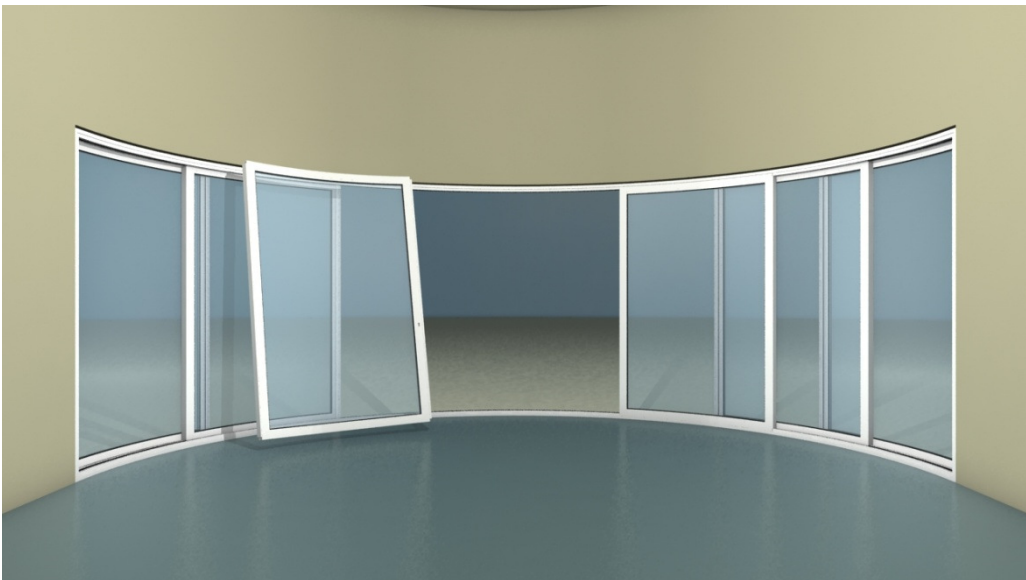

VisioGlide 100 System – W6-F Six doors – 2 fixed, 4 sliding

25. Fix the top frame to the opening.

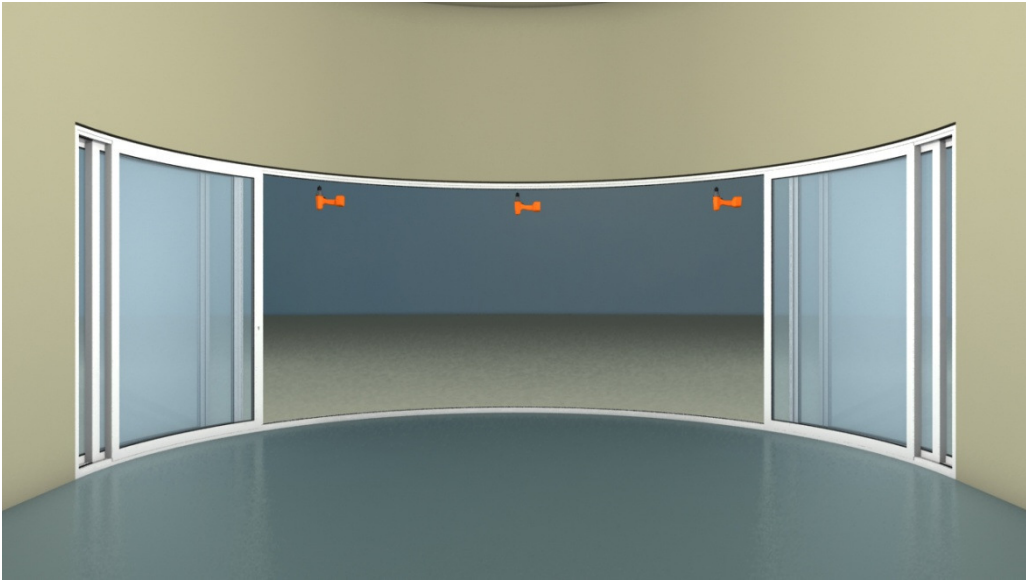

26. Fix the top draft seals in place



VisioGlide 100 System – W6-F Six doors – 2 fixed, 4 sliding

27. Install the handles

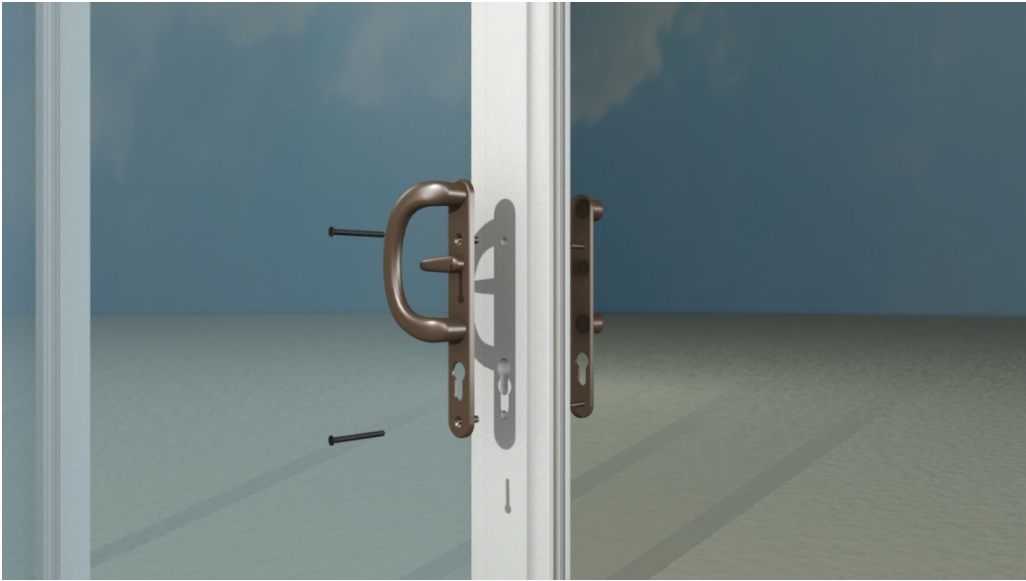

28. If not already installed fix in place the door stop



VisioGlide 100 System – W6-F Six doors – 2 fixed, 4 sliding

29. Fix all the sash end covers in place



30. Seal the entire frame from the inside

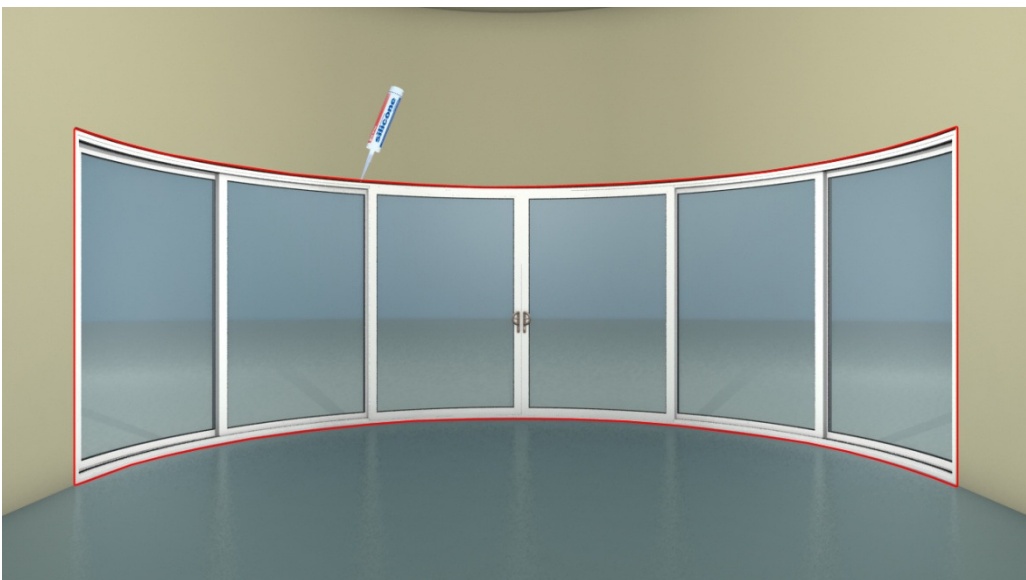

VisioGlide 100 System – W6-F Six doors – 2 fixed, 4 sliding



©Balconette 2016
www.balconette.co.uk

Tel: +44 1342 410411
Fax: +44 1342 410412

Unit 6, Systems House, Eastbourne Road, Blindley Heath, Lingfield, Surrey, RH7 6JP,
United Kingdom