

HENLEYS MEDICAL SUPPLIES

2015/16 CATALOGUE

Footwear
Thermometry
ECG Products
Pulse Oximetry
Blood Pressure
Patient Monitors
Bedding Protection
Respiratory Therapy
Dispensing Products

TENS
Cauteries
Containers
ECG Cables
Ultrasound Gels
Ophthalmic / ENT
Bedpans & Urinals
Proctological Products
Stainless Steel Instruments

Bags
Bowls
Wipes
Lighting
Enema Tips
Pen Torches
Vaginal Speculum
Protective Clothing
Medicine Measures

And More.....

	Theatres →
↑ Day Surgery	Accident & Emergency ↑
← Outpatients	Medical Physics →
↑ Wards	Maternity ↗
↙ Obstetrics	Therapies ↑
← Radiology	Critical Care ↗
↖ Respiratory	Oncology →
↗ Neonatal	Clinics ↑
← Paediatrics	Women's Health →
↖ Ultrasound	



View, order or buy our products at
www.henleysmed.com

Catalogue Sections by Speciality

Speciality	Catalogue Section Number
Accident and Emergency	S01-S14, S17, S19, S23, S24, S26, S27, S28, S30, S32, S33, S36, S38
Anaesthetics	S01-S04, S06, S12, S17, S22, S33
Cardiology	S01, S03, S04, S12, S17, S24, S33
Cardiothoracic Surgery	S01-S07, S09, S12, S14, S15, S16, S17, S22, S24, S27, S32, S33
Colorectal	S09, S10, S33, S34, S36
Critical Care	S01-S07, S09, S12, S14, S17, S18, S22, S23, S24, S26, S27, S28, S31, S32, S33, S36, S37, S38
Day Surgery	S01-S12, S14, S15, S16, S17, S22, S23, S24, S26, S27, S28, S30, S32, S33, S34, S36, S38
Dermatology	S08, S09, S24, S27, S36, S38
Diagnostic Imaging	S03, S12
Diagnostic Physiological Measurement	S01, S03, S04, S17
Ear, Nose & Throat	S08, S09, S14, S27, S36, S38
Elderly Services	S01, S03-S05, S07-S09, S17-S28, S30-S33, S38
General Medical & Surgical Wards	S01, S03-S12, S17-S20, S21-S33, S36-S38
General Surgery	S01-S12, S14-S17, S22, S23, S24, S26-S28, S30, S32-S34, S36, S38
Obstetrics & Gynaecology	S01, S03, S05-S07, S09, S11-S14, S22, S24, S26, S27, S30, S33, S36, S38
Maternity	S01, S03, S04, S07-S09, S11-S13, S17-S22, S24-S28, S30-S33, S36, S38
Medical Physics (EBME)	S01-S09, S13, S17, S23, S24, S32, S33, S35-S37
Microbiology	S08, S09, S19, S23, S27-S33, S36-S38
Minor Injuries	S01-S14, S17, S19, S23, S24, S26-S28, S30, S32, S33, S36, S38
Neonatal (SCBU)	S01-S05, S07-S09, S12-S14, S17, S19, S23, S27, S28, S31-S33, S36-S38
Neurology & Neurosurgery	S01-S04, S06-S09, S14-S17, S22, S23, S24, S27, S28, S30-S33, S36-S38
Ophthalmology	S08, S09, S14, S24, S27, S36, S38
Oral and Maxillofacial Surgery	S01-S04, S06-S09, S14-S17, S22, S23, S24, S27, S28, S32, S33, S36, S38
Orthopaedic Surgery	S01-S04, S06, S07, S09, S14-S17, S22, S23, S24, S27, S28, S32, S33, S36, S38
Outpatients	S01, S03-S14, S17, S19, S23, S24, S29-S38
Pain Management	S35
Pathology	S19, S23, S27-S33, S37, S38
Pharmacy	S19, S23, S27-S33, S37, S38
Physiotherapy	S12, S17, S20, S24, S38
Plastic Surgery	S01-S04, S06-S09, S14-S17, S22, S23, S24, S26-S29, S32, S33, S36, S38
Procurement	S01-S38
Recovery	S01-S04, S06-S09, S17, S18, S23, S24, S26, S28, S30, S32, S33, S36, S38
Respiratory Medicine	S04, S17
Sexual Health Services	S07, S09-S11, S13, S14, S19, S23, S24, S27, S28, S30, S31, S33, S38
Sleep Medicine	S01, S03-S05, S08, S17, S20, S23, S33
Sterile Services	S19, S27, S33, S36
Vascular Surgery	S01-S04, S06, S09, S12, S14-S17, S22, S23, S24, S27, S28, S31-S33, S36-S38



Section	Page
S01 - Blood Pressure - Blood Pressure Cuffs, Connectors, Hoses, Sphygmomanometers & Spares, Invasive Blood Pressure Transducers, Invasive Blood Pressure Cables	1-16
S02 - Thermometry - Reusable & Disposable Temperature Probes, Accessories	17-18
S03 - ECG Monitoring - Monitors, 3-Lead Cables, 5-Lead Cables, 10-Lead Cables, Patient Leadwires, Adaptors, Electrodes, Video Imaging Paper, ECG Gels	19-32
S04 - Pulse Oximetry - Pulse Oximeter Sensors, Monitors	33
S05 - Patient Monitoring - Vital Signs Monitors	34
S06 - Infusion Products - Unifusor Infusion Cuffs, Unimed Infusion Cuffs, Accoson Infusion Cuffs, KaWe Infusion Stand	35
S07 - Stethoscopes - Henley Stethoscopes, Littmann Stethoscopes	36-37
S08 - Ophthalmic / ENT - Oscopes, Ophthalmoscopes, Dermatoscopes, Combined Diagnostic Sets, Wall-Mounted Diagnostic Sets, Binocular Magnifying Glasses, Penlights, Lamps, Laryngoscopes, Handles & Chargers	38-49
S09 - Lighting - Headlights, Examination Lights, Forehead Lights	50-51
S10 - Proctological Products - Proctoscopes, Sigmoidoscopes	52-53
S11 - Gynaecological Products - Vaginal Speculum	54
S12 - Ultrasound Products - Ultrasound Gels, Lotions, Pads, Dispensers, Probe Covers, Couch Rolls	55
S13 - Foetal Dopplers & Transducers - Foetal Dopplers, Foetal Transducers, Transducer Belts, Event Mark Cables, Nurse Call Cords	56-57
S14 - Surgical Instruments - Cauteries, Electrosurgical High Frequency Generators, Electrosurgical Pencils & Electrodes, Electrosurgical Loops & Squares, Ophthalmic Burrs, Nerve Locators, Lights, Pentorches & Stylets, Bipolar Forceps	58-63
S15 - Vesselcare - Vesselpaws, Suture-Boots, Vesseloops, Snugger Venous Catheter	64
S16 - Vascular & Digestive Catheters - Arterial Embolectomy, Venous Thrombectomy, Occlusion, Irrigation, Biliary	65
S17 - Respiratory Therapy - Masks, Cannulae, Cannula Securement, Tubing, Humidifiers, Compressors, Nebulisers, Mucus Clearance Devices, Incentive Spirometers, Monitors, Fuel Cells, Holding Chambers, PEP Products, PAP Products, Pulmonary Function Filters	66-79
S18 - Feeding Aids - Bibs, Drinking Beakers	80
S19 - Protective Clothing & Footwear - Foam Slippers, Hard Sole Slippers, Overshoes, Bed Boots & Booties, Capes, Gowns, Aprons, Protective Sleeves, Gloves, Caps, Coveralls, Beard Masks, Dispensers	81-83
S20 - Cushions & Supports - Fleece, Cushions, Wedges, Armchair Bedrests, Abduction Products, Trolley Mattresses	84-85
S21 - Heel & Elbow Protectors - Heel Protectors, Elbow Protectors	86
S22 - Patient Positioners - Operating Room Patient Head Supports, Patient Body Supports, Positioners	87
S23 - Wipes - Hand & Face Wipes, Bodycare Wipes, Dry Wipes, Hard Surface Alcohol Wipes, Detergent Wipes, Alcohol-Free Wipes, Prep Wipes	88-91
S24 - Bedding Protection - <i>Total Confidence</i> & <i>Pretty Confidence</i> Mattress Covers, Mattress Protectors, Pillow Cases, Duvet Covers, Sheeting, CleanPatch - Medical Surface Repair Patch	92-95
S25 - Continence - Reusable & Disposable Incontinence Pants	96
S26 - Bedpans, Urinals & Accessories - Bedpans, Urinals, Commode Specimen Collector, Urinal Bags, GelMax, Accessories	97-98
S27 - Instrument Trays - Reusable Polypropylene Instrument Trays, Mesh Polypropylene Instrument Trays, Perforated Polypropylene Instrument Trays, Compartmented Polypropylene Trays, Silicone Mats for DIN Trays	99-100
S28 - Bowls, Gallipots & Kidney Dishes - Polypropylene Bowls, Polypropylene Kidney Dishes, Polypropylene Gallipots	101
S29 - Containers - Clear Plastic Boxes, Screw-Cap Containers, Snap-Lid Containers, Plastic Tubes, Denture Containers	102-103
S30 - Dispensing Products - Medicine Measures, Dispensing Spoons, Dispensing Bags, Ondula Ampoule Boxes	104
S31 - Funnels & Jugs - Measuring Jugs, Funnels	105
S32 - Bags - Resealable Bags, Write-On Bags, Printed Bags, Specimen Bags, Biohazard Bags	106
S33 - Labels - Syringe Labels, I.V. Line Labels, Drug Additive Labels, Self-Adhesive Labels	107
S34 - Enema Products - Barium Enema Tips, Insufflators, Bags, Spillage Rings	108
S35 - TENS - TENS Units, Electrodes, Leadwires, Gels	109-110
S36 - Stainless Steel Instruments - Stainless Steel Surgical Instruments, Instrument Marking Tape	111
S37 - Tubing Connectors & Accessories - Straight Connectors, Reducing Connectors, 'L' Connectors, 'Y' Connectors, 'T' Connectors, 120° Connectors, 4 Way Connectors, Disconnectors, Tubing Clamps and Clips	112-113
S38 - Uncategorized - Neonatal IV Supports, Neonatal Phototherapy Eye Shades, Umbilical Vessel Catheters, Mucus Extractors & Traps, Disposable Tape Measures, IV Armboards, Patient ID Bands, Strap Closures, Curity Gauze Sponge, Micro Cover Slips, Mixing Needles, Wash Squares, Blood Lancets, Urine Drainage Bag Hangers, Vomit Bags, Disposable Razors, Patella Hammers, Tongue Depressors, Wooden Applicators, Marker Pens, Lemon & Glycerine Swabs, Catheter Spigots, Absorbent Theatre Mats, Dissecting Forceps, Tourniquets, Screen & Shower Curtains	114-118

Section 01 - Blood Pressure

Neonatal Disposable One-Piece Blood Pressure Cuffs

Our range of neonatal cuffs is available in three high quality materials: a soft DuPont Sontara® fabric version, a PVC-free polyurethane version and a vinyl version. Both double-tube and single-tube options can be supplied, ranging from size 1 to 5. They are supplied with a 5/16" male luer slip connection, 3/16" male luer slip connection (DuPont Sontara® fabric and Vinyl versions only) or a bayonet fitting.

Neonatal Cuffs with Male Luer Slip Connector

Non-Sterile DuPont Sontara® Fabric with Luer Slip				Pack	Price
NN1ST	CUFF SINGLE TUBE	SIZE 1 3-6cm	10	32.00	
NN1DT	CUFF DOUBLE TUBE	SIZE 1 3-6cm	10	32.00	
NN2ST	CUFF SINGLE TUBE	SIZE 2 4-8cm	10	32.00	
NN2DT	CUFF DOUBLE TUBE	SIZE 2 4-8cm	10	32.00	
NN3ST	CUFF SINGLE TUBE	SIZE 3 6-11cm	10	32.00	
NN3DT	CUFF DOUBLE TUBE	SIZE 3 6-11cm	10	32.00	
NN4ST	CUFF SINGLE TUBE	SIZE 4 7-13cm	10	32.00	
NN4DT	CUFF DOUBLE TUBE	SIZE 4 7-13cm	10	32.00	
NN5ST	CUFF SINGLE TUBE	SIZE 5 8-15cm	10	32.00	
NN5DT	CUFF DOUBLE TUBE	SIZE 5 8-15cm	10	32.00	
NN1STM316	CUFF SINGLE TUBE	SIZE 1 3-6cm	10	32.00	
NN2STM316	CUFF SINGLE TUBE	SIZE 2 4-8cm	10	32.00	
NN3STM316	CUFF SINGLE TUBE	SIZE 3 6-11cm	10	32.00	
NN4STM316	CUFF SINGLE TUBE	SIZE 4 7-13cm	10	32.00	
NN5STM316	CUFF SINGLE TUBE	SIZE 5 8-15cm	10	32.00	

Non-Sterile Vinyl with Luer Slip				Pack	Price
VNN1ST	CUFF SINGLE TUBE	SIZE 1 3-6cm	10	32.00	
VNN1DT	CUFF DOUBLE TUBE	SIZE 1 3-6cm	10	32.00	
VNN2ST	CUFF SINGLE TUBE	SIZE 2 4-8cm	10	32.00	
VNN2DT	CUFF DOUBLE TUBE	SIZE 2 4-8cm	10	32.00	
VNN3ST	CUFF SINGLE TUBE	SIZE 3 6-11cm	10	32.00	
VNN3DT	CUFF DOUBLE TUBE	SIZE 3 6-11cm	10	32.00	
VNN4ST	CUFF SINGLE TUBE	SIZE 4 7-13cm	10	32.00	
VNN4DT	CUFF DOUBLE TUBE	SIZE 4 7-13cm	10	32.00	
VNN5ST	CUFF SINGLE TUBE	SIZE 5 8-15cm	10	32.00	
VNN5DT	CUFF DOUBLE TUBE	SIZE 5 8-15cm	10	32.00	
VNN1STM316	CUFF SINGLE TUBE	SIZE 1 3-6cm	10	32.00	
VNN2STM316	CUFF SINGLE TUBE	SIZE 2 4-8cm	10	32.00	
VNN3STM316	CUFF SINGLE TUBE	SIZE 3 6-11cm	10	32.00	
VNN4STM316	CUFF SINGLE TUBE	SIZE 4 7-13cm	10	32.00	
VNN5STM316	CUFF SINGLE TUBE	SIZE 5 8-15cm	10	32.00	

Non-Sterile PVC-Free Polyurethane with Luer Slip				Pack	Price
PNN1ST	CUFF SINGLE TUBE	SIZE 1 3-6cm	10	37.00	
PNN1DT	CUFF DOUBLE TUBE	SIZE 1 3-6cm	10	37.00	
PNN2ST	CUFF SINGLE TUBE	SIZE 2 4-8cm	10	37.00	
PNN2DT	CUFF DOUBLE TUBE	SIZE 2 4-8cm	10	37.00	
PNN3ST	CUFF SINGLE TUBE	SIZE 3 6-11cm	10	37.00	
PNN3DT	CUFF DOUBLE TUBE	SIZE 3 6-11cm	10	37.00	
PNN4ST	CUFF SINGLE TUBE	SIZE 4 7-13cm	10	37.00	
PNN4DT	CUFF DOUBLE TUBE	SIZE 4 7-13cm	10	37.00	
PNN5ST	CUFF SINGLE TUBE	SIZE 5 8-15cm	10	37.00	
PNN5DT	CUFF DOUBLE TUBE	SIZE 5 8-15cm	10	37.00	

Neonatal Cuffs with Bayonet Connector

Non-Sterile Vinyl with Bayonet				Pack	Price
VNN1STHP	CUFF SINGLE TUBE	SIZE 1 3-6cm	10	32.00	
VNN2STHP	CUFF SINGLE TUBE	SIZE 2 4-8cm	10	32.00	
VNN3STHP	CUFF SINGLE TUBE	SIZE 3 6-11cm	10	32.00	
VNN4STHP	CUFF SINGLE TUBE	SIZE 4 7-13cm	10	32.00	
VNN5STHP	CUFF SINGLE TUBE	SIZE 5 8-15cm	10	32.00	

Non-Sterile DuPont Sontara® Fabric with Bayonet				Pack	Price
NN1STHP	CUFF SINGLE TUBE	SIZE 1 3-6cm	10	32.00	
NN2STHP	CUFF SINGLE TUBE	SIZE 2 4-8cm	10	32.00	
NN3STHP	CUFF SINGLE TUBE	SIZE 3 6-11cm	10	32.00	
NN4STHP	CUFF SINGLE TUBE	SIZE 4 7-13cm	10	32.00	
NN5STHP	CUFF SINGLE TUBE	SIZE 5 8-15cm	10	32.00	

Non-Sterile PVC-Free Polyurethane with Bayonet				Pack	Price
PNN1STHP	CUFF SINGLE TUBE	SIZE 1 3-6cm	10	37.00	
PNN2STHP	CUFF SINGLE TUBE	SIZE 2 4-8cm	10	37.00	
PNN3STHP	CUFF SINGLE TUBE	SIZE 3 6-11cm	10	37.00	
PNN4STHP	CUFF SINGLE TUBE	SIZE 4 7-13cm	10	37.00	
PNN5STHP	CUFF SINGLE TUBE	SIZE 5 8-15cm	10	37.00	



Connectors

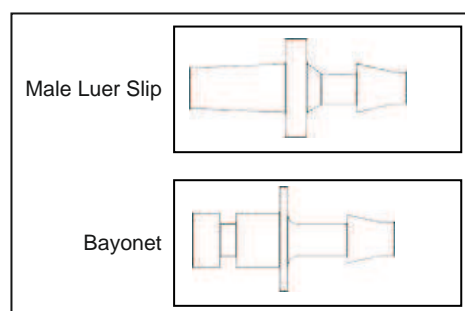

Curve™ One-Piece Bariatric Blood Pressure Cuffs

Worldwide obesity rates are climbing. This disease is strongly associated with increased mortality and morbidity, cardiovascular disease, diabetes and many other illnesses. Blood pressure is the number one vital sign in detecting these issues.



Reusable Single-Tube

Cat No		Size	Pack	Price
BRUS3854	CUFF SINGLE TUBE	38-54cm	Each	45.00
BRUS3854HP	CUFF SINGLE TUBE	38-54cm	Each	45.00
BRUS3854ML	CUFF SINGLE TUBE	38-54cm	Each	45.00
BRUS3854FL	CUFF SINGLE TUBE	38-54cm	Each	45.00
BRUS3854MQ	CUFF SINGLE TUBE	38-54cm	Each	45.00
BRUS3854MQML	CUFF SINGLE TUBE	38-54cm	Each	45.00

Reusable Double-Tube

Cat No		Size	Pack	Price
BRUD3854	CUFF DOUBLE TUBE	38-54cm	Each	45.00
BRUD3854MQ	CUFF DOUBLE TUBE	38-54cm	Each	45.00
BRUD3854MQMF	CUFF DOUBLE TUBE	38-54cm	Each	45.00
BRUD3854MB	CUFF DOUBLE TUBE	38-54cm	Each	45.00

Disposable Single-Tube

Cat No		Size	Pack	Price
BRST3854	CUFF SINGLE TUBE	38-54cm	Each	18.00
BRST3854HP	CUFF SINGLE TUBE	38-54cm	Each	18.00
BRST3854ML	CUFF SINGLE TUBE	38-54cm	Each	18.00
BRST3854FL	CUFF SINGLE TUBE	38-54cm	Each	18.00
BRST3854MQ	CUFF SINGLE TUBE	38-54cm	Each	18.00
BRST3854MQML	CUFF SINGLE TUBE	38-54cm	Each	18.00

Disposable Double-Tube

Cat No		Size	Pack	Price
BRDT3854	CUFF DOUBLE TUBE	38-54cm	Each	18.00
BRDT3854MQ	CUFF DOUBLE TUBE	38-54cm	Each	18.00
BRDT3854MQMF	CUFF DOUBLE TUBE	38-54cm	Each	18.00
BRDT3854MB	CUFF DOUBLE TUBE	38-54cm	Each	18.00

Accurate Blood Pressure is Critical

- UltraCheck & SoftCheck Curve Cuffs are designed to fit the patient's arm correctly
- Conical shape fits snugly against the arm & properly compresses the artery

Features

- Will not slide during inflation
- Meets AHA/ AAMI Standards
- Genuine Velcro® closures
- Manufactured without natural latex
- Adapters allow for compatibility with monitors worldwide

Two Styles Available:

UltraCheck Curve Reusable

- Anti-microbial protection built into the fabric guards against microbial deterioration which can affect the physical properties of the material
- Manufactured without PVC / DEHP

SoftCheck Curve Disposable

- Soft fabric helps prevent perspiration under cuff which can lead to skin breakdown

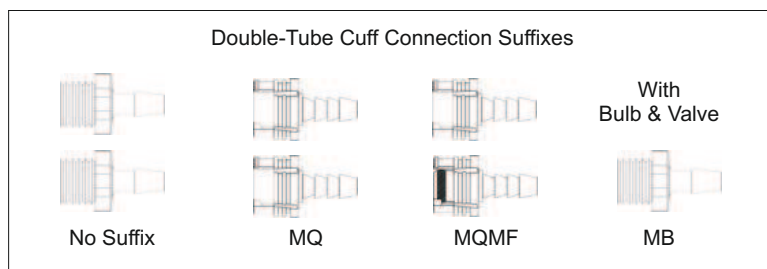
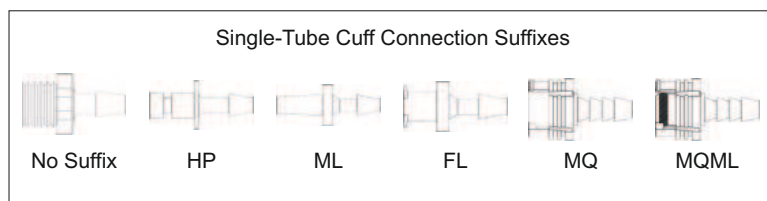

Section 01 - Blood Pressure



Fabric

These products are single-patient use and are made from a soft DuPont Sontara® fabric. They range in size from 8cm to 50cm, with both single- and double-tube options available. They meet AHA and AAMI standards for size and accuracy. Connectors are available for most NIBP devices and are pre-fitted for the most popular types. These cuffs are soft, comfortable and supplied with hook and loop fastenings.

Disposable One-Piece Single-Tube Blood Pressure Cuffs - Fabric



Size	Screw Connector				Bayonet Connector				Male Luer Slip Connector			
	Cat No	Pack	Price	10+	Cat No	Pack	Price	10+	Cat No	Pack	Price	10+
INFANT	ST0814	Each	5.75	5.25	ST0814HP	Each	5.75	5.25	ST0814ML	Each	5.75	5.25
CHILD	ST1320	Each	5.75	5.25	ST1320HP	Each	5.75	5.25	ST1320ML	Each	5.75	5.25
SMALL ADULT	ST1826	Each	5.75	5.25	ST1826HP	Each	5.75	5.25	ST1826ML	Each	5.75	5.25
ADULT	ST2635	Each	5.75	5.25	ST2635HP	Each	5.75	5.25	ST2635ML	Each	5.75	5.25
ADULT LONG	ST2938	Each	5.75	5.25	ST2938HP	Each	5.75	5.25	ST2938ML	Each	5.75	5.25
LARGE ADULT	ST3242	Each	5.75	5.25	ST3242HP	Each	5.75	5.25	ST3242ML	Each	5.75	5.25
LARGE ADULT LONG	ST3544	Each	5.75	5.25	ST3544HP	Each	5.75	5.25	ST3544ML	Each	5.75	5.25
THIGH	ST4250	Each	5.75	5.25	ST4250HP	Each	5.75	5.25	ST4250ML	Each	5.75	5.25



Size	Female Luer Slip Connection				Male Locking Connector				Female Locking Connector			
	Cat No	Pack	Price	10+	Cat No	Pack	Price	10+	Cat No	Pack	Price	10+
INFANT	ST0814FL	Each	5.75	5.25	ST0814MQML	Each	6.75	6.25	ST0814MQ	Each	6.75	6.25
CHILD	ST1320FL	Each	5.75	5.25	ST1320MQML	Each	6.75	6.25	ST1320MQ	Each	6.75	6.25
SMALL ADULT	ST1826FL	Each	5.75	5.25	ST1826MQML	Each	6.75	6.25	ST1826MQ	Each	6.75	6.25
ADULT	ST2635FL	Each	5.75	5.25	ST2635MQML	Each	6.75	6.25	ST2635MQ	Each	6.75	6.25
ADULT LONG	ST2938FL	Each	5.75	5.25	ST2938MQML	Each	6.75	6.25	ST2938MQ	Each	6.75	6.25
LARGE ADULT	ST3242FL	Each	5.75	5.25	ST3242MQML	Each	6.75	6.25	ST3242MQ	Each	6.75	6.25
LARGE ADULT LONG	ST3544FL	Each	5.75	5.25	ST3544MQML	Each	6.75	6.25	ST3544MQ	Each	6.75	6.25
THIGH	ST4250FL	Each	5.75	5.25	ST4250MQML	Each	6.75	6.25	ST4250MQ	Each	6.75	6.25

Disposable One-Piece Double-Tube Blood Pressure Cuffs - Fabric

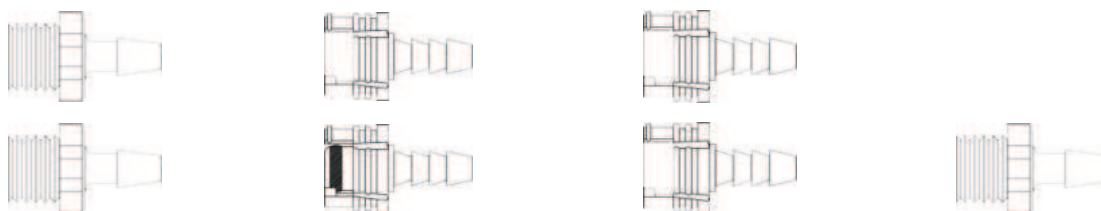

Size	Screw Connector				Male/Female Locking Connector				Female/Female Locking Connector				Bulb & Valve			
	Cat No	Pack	Price	10+	Cat No	Pack	Price	10+	Cat No	Pack	Price	10+	Cat No	Pack	Price	10+
INFANT	DT0814	Each	5.75	5.25	DT0814MQMF	Each	6.75	6.25	DT0814MQ	Each	6.75	6.25	DT0814MB	Each	9.00	8.50
CHILD	DT1320	Each	5.75	5.25	DT1320MQMF	Each	6.75	6.25	DT1320MQ	Each	6.75	6.25	DT1320MB	Each	9.00	8.50
SMALL ADULT	DT1826	Each	5.75	5.25	DT1826MQMF	Each	6.75	6.25	DT1826MQ	Each	6.75	6.25	DT1826MB	Each	9.00	8.50
ADULT	DT2635	Each	5.75	5.25	DT2635MQMF	Each	6.75	6.25	DT2635MQ	Each	6.75	6.25	DT2635MB	Each	9.00	8.50
ADULT LONG	DT2938	Each	5.75	5.25	DT2938MQMF	Each	6.75	6.25	DT2938MQ	Each	6.75	6.25	DT2938MB	Each	9.00	8.50
LARGE ADULT	DT3242	Each	5.75	5.25	DT3242MQMF	Each	6.75	6.25	DT3242MQ	Each	6.75	6.25	DT3242MB	Each	9.00	8.50
LARGE ADULT LONG	DT3544	Each	5.75	5.25	DT3544MQMF	Each	6.75	6.25	DT3544MQ	Each	6.75	6.25	DT3544MB	Each	9.00	8.50
THIGH	DT4250	Each	5.75	5.25	DT4250MQMF	Each	6.75	6.25	DT4250MQ	Each	6.75	6.25	DT4250MB	Each	9.00	8.50



Section 01 - Blood Pressure



Vinyl

These products are single-patient use and are made from a soft vinyl material. They range in size from 8cm to 50cm, with both single- and double-tube options available. They meet AHA and AAMI standards for size and accuracy. Connectors are available for most NIBP devices and are pre-fitted for the most popular types. These cuffs are soft, comfortable and supplied with hook and loop fastenings.

Disposable One-Piece Single-Tube Blood Pressure Cuffs - Vinyl



Size	Screw Connector					Bayonet Connector					Male Luer Slip Connector				
	Cat No	Pack	Price	10+		Cat No	Pack	Price	10+		Cat No	Pack	Price	10+	
INFANT	VST0814	Each	5.75	5.25		VST0814HP	Each	5.75	5.25		VST0814ML	Each	5.75	5.25	
CHILD	VST1320	Each	5.75	5.25		VST1320HP	Each	5.75	5.25		VST1320ML	Each	5.75	5.25	
SMALL ADULT	VST1826	Each	5.75	5.25		VST1826HP	Each	5.75	5.25		VST1826ML	Each	5.75	5.25	
ADULT	VST2635	Each	5.75	5.25		VST2635HP	Each	5.75	5.25		VST2635ML	Each	5.75	5.25	
ADULT LONG	VST2938	Each	5.75	5.25		VST2938HP	Each	5.75	5.25		VST2938ML	Each	5.75	5.25	
LARGE ADULT	VST3242	Each	5.75	5.25		VST3242HP	Each	5.75	5.25		VST3242ML	Each	5.75	5.25	
LARGE ADULT LONG	VST3544	Each	5.75	5.25		VST3544HP	Each	5.75	5.25		VST3544ML	Each	5.75	5.25	
THIGH	VST4250	Each	5.75	5.25		VST4250HP	Each	5.75	5.25		VST4250ML	Each	5.75	5.25	



Size	Female Luer Slip Connector					Male Locking Connector					Female Locking Connector				
	Cat No	Pack	Price	10+		Cat No	Pack	Price	10+		Cat No	Pack	Price	10+	
INFANT	VST0814FL	Each	5.75	5.25		VST0814MQML	Each	6.75	6.25		VST0814MQ	Each	6.75	6.25	
CHILD	VST1320FL	Each	5.75	5.25		VST1320MQML	Each	6.75	6.25		VST1320MQ	Each	6.75	6.25	
SMALL ADULT	VST1826FL	Each	5.75	5.25		VST1826MQML	Each	6.75	6.25		VST1826MQ	Each	6.75	6.25	
ADULT	VST2635FL	Each	5.75	5.25		VST2635MQML	Each	6.75	6.25		VST2635MQ	Each	6.75	6.25	
ADULT LONG	VST2938FL	Each	5.75	5.25		VST2938MQML	Each	6.75	6.25		VST2938MQ	Each	6.75	6.25	
LARGE ADULT	VST3242FL	Each	5.75	5.25		VST3242MQML	Each	6.75	6.25		VST3242MQ	Each	6.75	6.25	
LARGE ADULT LONG	VST3544FL	Each	5.75	5.25		VST3544MQML	Each	6.75	6.25		VST3544MQ	Each	6.75	6.25	
THIGH	VST4250FL	Each	5.75	5.25		VST4250MQML	Each	6.75	6.25		VST4250MQ	Each	6.75	6.25	

Disposable One-Piece Double-Tube Blood Pressure Cuffs - Vinyl

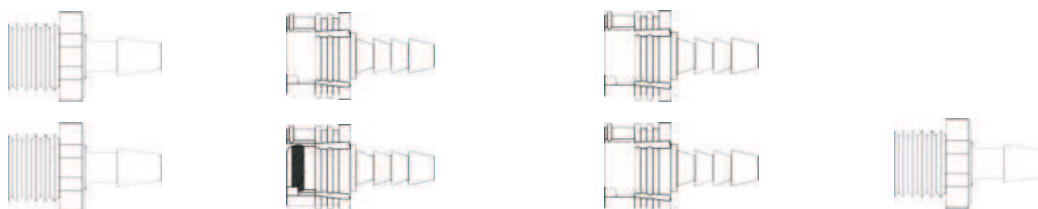

Size	Screw Connector					Male/Female Locking Connector					Female/Female Locking Connector					Bulb & Valve				
	Cat No	Pack	Price	10+		Cat No	Pack	Price	10+		Cat No	Pack	Price	10+		Cat No	Pack	Price	10+	
INFANT	VDT0814	Each	5.75	5.25		VDT0814MQMF	Each	6.75	6.25		VDT0814MQ	Each	6.75	6.25		VDT0814MB	Each	9.00	8.50	
CHILD	VDT1320	Each	5.75	5.25		VDT1320MQMF	Each	6.75	6.25		VDT1320MQ	Each	6.75	6.25		VDT1320MB	Each	9.00	8.50	
SMALL ADULT	VDT1826	Each	5.75	5.25		VDT1826MQMF	Each	6.75	6.25		VDT1826MQ	Each	6.75	6.25		VDT1826MB	Each	9.00	8.50	
ADULT	VDT2635	Each	5.75	5.25		VDT2635MQMF	Each	6.75	6.25		VDT2635MQ	Each	6.75	6.25		VDT2635MB	Each	9.00	8.50	
ADULT LONG	VDT2938	Each	5.75	5.25		VDT2938MQMF	Each	6.75	6.25		VDT2938MQ	Each	6.75	6.25		VDT2938MB	Each	9.00	8.50	
LARGE ADULT	VDT3242	Each	5.75	5.25		VDT3242MQMF	Each	6.75	6.25		VDT3242MQ	Each	6.75	6.25		VDT3242MB	Each	9.00	8.50	
LARGE ADULT LONG	VDT3544	Each	5.75	5.25		VDT3544MQMF	Each	6.75	6.25		VDT3544MQ	Each	6.75	6.25		VDT3544MB	Each	9.00	8.50	
THIGH	VDT4250	Each	5.75	5.25		VDT4250MQMF	Each	6.75	6.25		VDT4250MQ	Each	6.75	6.25		VDT4250MB	Each	9.00	8.50	

Disposable One-Piece Blood Pressure Cuffs - Yellow Vinyl



Size	Bayonet Connector					Male Luer Slip Connector					Screw Connector				
	Cat No	Pack	Price	10+		Cat No	Pack	Price	10+		Cat No	Pack	Price	10+	
SMALL ADULT	YVST1826HP	Each	5.75	5.25		YVST1826ML	Each	5.75	5.25		YVDT1826	Each	5.75	5.25	
ADULT	YVST2635HP	Each	5.75	5.25		YVST2635ML	Each	5.75	5.25		YVDT2635	Each	5.75	5.25	
LARGE ADULT	YVST3242HP	Each	5.75	5.25		YVST3242ML	Each	5.75	5.25		YVDT3242	Each	5.75	5.25	



Section 01 - Blood Pressure



These comfortable, stain-resistant, latex-free cuffs meet AHA and AAMI standards for size and accuracy. They have an antimicrobial coating to help prevent bacteria growth. Connectors are available for any type of NIBP device and are pre-fitted for the more popular types. Available with single or double tube and supplied with hook and loop fastenings.

Reusable One-Piece Single-Tube Blood Pressure Cuffs



Size	Screw Connector				Bayonet Connector Plastic				Bayonet Connector Metal				Male Luer Slip Connector			
	Cat No	Pack	Price	10+	Cat No	Pack	Price	10+	Cat No	Pack	Price	10+	Cat No	Pack	Price	10+
INFANT	US0814	Each	11.00	10.00	US0814HP	Each	11.00	10.00	US0814MHP	Each	16.00	15.00	US0814ML	Each	11.00	10.00
CHILD	US1320	Each	11.00	10.00	US1320HP	Each	11.00	10.00	US1320MHP	Each	16.00	15.00	US1320ML	Each	11.00	10.00
SMALL ADULT	US1826	Each	11.00	10.00	US1826HP	Each	11.00	10.00	US1826MHP	Each	16.00	15.00	US1826ML	Each	11.00	10.00
ADULT	US2635	Each	11.00	10.00	US2635HP	Each	11.00	10.00	US2635MHP	Each	16.00	15.00	US2635ML	Each	11.00	10.00
ADULT LONG	US2938	Each	11.00	10.00	US2938HP	Each	11.00	10.00	US2938MHP	Each	16.00	15.00	US2938ML	Each	11.00	10.00
LARGE ADULT	US3242	Each	11.00	10.00	US3242HP	Each	11.00	10.00	US3242MHP	Each	16.00	15.00	US3242ML	Each	11.00	10.00
LARGE ADULT LONG	US3544	Each	11.00	10.00	US3544HP	Each	11.00	10.00	US3544MHP	Each	16.00	15.00	US3544ML	Each	11.00	10.00
THIGH	US4250	Each	11.00	10.00	US4250HP	Each	11.00	10.00	US4250MHP	Each	16.00	15.00	US4250ML	Each	11.00	10.00



Size	Female Luer Slip Connector				Male Locking Connector				Female Locking Connector				Large Female Luer Slip Connector			
	Cat No	Pack	Price	10+	Cat No	Pack	Price	10+	Cat No	Pack	Price	10+	Cat No	Pack	Price	10+
INFANT	US0814FL	Each	11.00	10.00	US0814MQML	Each	11.00	10.00	US0814MQ	Each	11.00	10.00	US0814LBFL	Each	22.00	21.00
CHILD	US1320FL	Each	11.00	10.00	US1320MQML	Each	11.00	10.00	US1320MQ	Each	11.00	10.00	US1320LBFL	Each	22.00	21.00
SMALL ADULT	US1826FL	Each	11.00	10.00	US1826MQML	Each	11.00	10.00	US1826MQ	Each	11.00	10.00	US1826LBFL	Each	22.00	21.00
ADULT	US2635FL	Each	11.00	10.00	US2635MQML	Each	11.00	10.00	US2635MQ	Each	11.00	10.00	US2635LBFL	Each	22.00	21.00
ADULT LONG	US2938FL	Each	11.00	10.00	US2938MQML	Each	11.00	10.00	US2938MQ	Each	11.00	10.00	US2938LBFL	Each	22.00	21.00
LARGE ADULT	US3242FL	Each	11.00	10.00	US3242MQML	Each	11.00	10.00	US3242MQ	Each	11.00	10.00	US3242LBFL	Each	22.00	21.00
LARGE ADULT LONG	US3544FL	Each	11.00	10.00	US3544MQML	Each	11.00	10.00	US3544MQ	Each	11.00	10.00	US3544LBFL	Each	22.00	21.00
THIGH	US4250FL	Each	11.00	10.00	US4250MQML	Each	11.00	10.00	US4250MQ	Each	11.00	10.00	US4250LBFL	Each	22.00	21.00

Reusable One-Piece Double-Tube Blood Pressure Cuffs



Size	Screw Connector				Male/Female Locking Connector				Female/Female Locking Connector				Bulb & Valve			
	Cat No	Pack	Price	10+	Cat No	Pack	Price	10+	Cat No	Pack	Price	10+	Cat No	Pack	Price	10+
INFANT	UD0814	Each	11.00	10.00	UD0814MQMF	Each	11.00	10.00	UD0814MQ	Each	11.00	10.00	UD0814MB	Each	15.00	14.00
CHILD	UD1320	Each	11.00	10.00	UD1320MQMF	Each	11.00	10.00	UD1320MQ	Each	11.00	10.00	UD1320MB	Each	15.00	14.00
SMALL ADULT	UD1826	Each	11.00	10.00	UD1826MQMF	Each	11.00	10.00	UD1826MQ	Each	11.00	10.00	UD1826MB	Each	15.00	14.00
ADULT	UD2635	Each	11.00	10.00	UD2635MQMF	Each	11.00	10.00	UD2635MQ	Each	11.00	10.00	UD2635MB	Each	15.00	14.00
ADULT LONG	UD2938	Each	11.00	10.00	UD2938MQMF	Each	11.00	10.00	UD2938MQ	Each	11.00	10.00	UD2938MB	Each	15.00	14.00
LARGE ADULT	UD3242	Each	11.00	10.00	UD3242MQMF	Each	11.00	10.00	UD3242MQ	Each	11.00	10.00	UD3242MB	Each	15.00	14.00
LARGE ADULT LONG	UD3544	Each	11.00	10.00	UD3544MQMF	Each	11.00	10.00	UD3544MQ	Each	11.00	10.00	UD3544MB	Each	15.00	14.00
THIGH	UD4250	Each	11.00	10.00	UD4250MQMF	Each	11.00	10.00	UD4250MQ	Each	11.00	10.00	UD4250MB	Each	15.00	14.00



Section 01 - Blood Pressure



These comfortable, stain-resistant, latex-free cuffs are pre-fitted with connectors to fit any type of NIBP device. Available with single or double 50cm tubing and supplied with hook and loop fastenings.

Reusable Two-Piece Single-Tube Blood Pressure Cuffs



Size	No Connector				Screw Connector				Bayonet Connector			
	Cat No	Pack	Price	10+	Cat No	Pack	Price	10+	Cat No	Pack	Price	10+
INFANT	U1882S	Each	11.00	10.00	U1882SC08	Each	11.00	10.00	U1882SC12	Each	11.00	10.00
CHILD	U1881S	Each	11.00	10.00	U1881SC08	Each	11.00	10.00	U1881SC12	Each	11.00	10.00
SMALL ADULT	U1885S	Each	11.00	10.00	U1885SC08	Each	11.00	10.00	U1885SC12	Each	11.00	10.00
ADULT	U1880S	Each	11.00	10.00	U1880SC08	Each	11.00	10.00	U1880SC12	Each	11.00	10.00
ADULT LONG	U1886S	Each	11.00	10.00	U1886SC08	Each	11.00	10.00	U1886SC12	Each	11.00	10.00
LARGE ADULT	U1869S	Each	11.00	10.00	U1869SC08	Each	11.00	10.00	U1869SC12	Each	11.00	10.00
LARGE ADULT LONG	U1889S	Each	11.00	10.00	U1889SC08	Each	11.00	10.00	U1889SC12	Each	11.00	10.00
THIGH	U1884S	Each	11.00	10.00	U1884SC08	Each	11.00	10.00	U1884SC12	Each	11.00	10.00

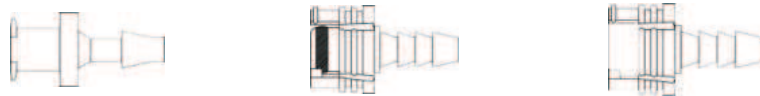

Size	Female Luer Slip Connector				Male Locking Connector				Female Locking Connector			
	Cat No	Pack	Price	10+	Cat No	Pack	Price	10+	Cat No	Pack	Price	10+
INFANT	U1882SC03	Each	11.00	10.00	U1882SC17	Each	11.00	10.00	U1882SC18	Each	11.00	10.00
CHILD	U1881SC03	Each	11.00	10.00	U1881SC17	Each	11.00	10.00	U1881SC18	Each	11.00	10.00
SMALL ADULT	U1885SC03	Each	11.00	10.00	U1885SC17	Each	11.00	10.00	U1885SC18	Each	11.00	10.00
ADULT	U1880SC03	Each	11.00	10.00	U1880SC17	Each	11.00	10.00	U1880SC18	Each	11.00	10.00
ADULT LONG	U1886SC03	Each	11.00	10.00	U1886SC17	Each	11.00	10.00	U1886SC18	Each	11.00	10.00
LARGE ADULT	U1869SC03	Each	11.00	10.00	U1869SC17	Each	11.00	10.00	U1869SC18	Each	11.00	10.00
LARGE ADULT LONG	U1889SC03	Each	11.00	10.00	U1889SC17	Each	11.00	10.00	U1889SC18	Each	11.00	10.00
THIGH	U1884SC03	Each	11.00	10.00	U1884SC17	Each	11.00	10.00	U1884SC18	Each	11.00	10.00

Reusable Two-Piece Double-Tube Blood Pressure Cuffs

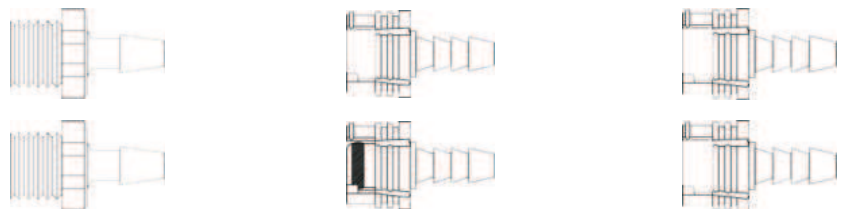

Size	No Connector				Screw Connector				Male/Female Locking Connector				Female/Female Locking Connector			
	Cat No	Pack	Price	10+	Cat No	Pack	Price	10+	Cat No	Pack	Price	10+	Cat No	Pack	Price	10+
INFANT	U1882D	Each	11.00	10.00	U1882DC0808	Each	11.00	10.00	U1882DC1718	Each	11.00	10.00	U1882DC1818	Each	11.00	10.00
CHILD	U1881D	Each	11.00	10.00	U1881DC0808	Each	11.00	10.00	U1881DC1718	Each	11.00	10.00	U1881DC1818	Each	11.00	10.00
SMALL ADULT	U1885D	Each	11.00	10.00	U1885DC0808	Each	11.00	10.00	U1885DC1718	Each	11.00	10.00	U1885DC1818	Each	11.00	10.00
ADULT	U1880D	Each	11.00	10.00	U1880DC0808	Each	11.00	10.00	U1880DC1718	Each	11.00	10.00	U1880DC1818	Each	11.00	10.00
ADULT LONG	U1886D	Each	11.00	10.00	U1886DC0808	Each	11.00	10.00	U1886DC1718	Each	11.00	10.00	U1886DC1818	Each	11.00	10.00
LARGE ADULT	U1869D	Each	11.00	10.00	U1869DC0808	Each	11.00	10.00	U1869DC1718	Each	11.00	10.00	U1869DC1818	Each	11.00	10.00
LARGE ADULT LONG	U1889D	Each	11.00	10.00	U1889DC0808	Each	11.00	10.00	U1889DC1718	Each	11.00	10.00	U1889DC1818	Each	11.00	10.00
THIGH	U1884D	Each	11.00	10.00	U1884DC0808	Each	11.00	10.00	U1884DC1718	Each	11.00	10.00	U1884DC1818	Each	11.00	10.00

Section 01 - Blood Pressure

Nipset® Blood Pressure Cuff Connection System

Nipset is designed to safely reduce compatibility problems between cuff and monitor types. The Nipset system incorporates two connectors, one BLUE and one GREEN. Simply attach the GREEN connector to the monitor hose and the BLUE connector to your cuff hose to create a safe, 100% air-tight, cost-effective method for connecting your blood pressure cuffs. Our range of disposable and reusable Cuffi® cuffs are available complete with a Nipset connector.

Cat No		Pack	Price
F001	NIPSET GREEN HOSE-END FOR SINGLE HOSES	5	15.00
F002	NIPSET GREEN HOSE-END FOR DOUBLE HOSES	5	15.00
M003	NIPSET BLUE CUFF-END (SINGLE HOSE ONLY)	20	126.00



Cuffi® Disposable One-Piece Blood Pressure Cuffs

These products are single-patient use and are made from a soft DuPont Sontara® fabric. They range in size from 8cm to 50cm and meet AHA and AAMI standards for size and accuracy. Available in single-hose style only with a Nipset® connector and hook and loop fastenings.



DuPont Sontara® Fabric		Pack	Price
CAS201	CUFFI CUFF SINGLE TUBE WITH NIPSET CONNECTOR INFANT	Each	6.00
CAS202	CUFFI CUFF SINGLE TUBE WITH NIPSET CONNECTOR CHILD	Each	6.40
CAS203	CUFFI CUFF SINGLE TUBE WITH NIPSET CONNECTOR SMALL ADULT	Each	6.80
CAS204	CUFFI CUFF SINGLE TUBE WITH NIPSET CONNECTOR ADULT	Each	7.00
CAS205	CUFFI CUFF SINGLE TUBE WITH NIPSET CONNECTOR ADULT LONG	Each	7.20
CAS206	CUFFI CUFF SINGLE TUBE WITH NIPSET CONNECTOR LARGE ADULT	Each	7.40
CAS207	CUFFI CUFF SINGLE TUBE WITH NIPSET CONNECTOR THIGH	Each	7.60

Cuffi® Reusable One-Piece Blood Pressure Cuffs

These comfortable, stain-resistant, latex-free cuffs meet AHA and AAMI standards for size and accuracy. They have an antimicrobial coating to help prevent bacteria growth. Available in single hose-style only complete with a Nipset® connector and hook and loop fastenings.



Cat No		Pack	Price
CA101N	CUFFI CUFF SINGLE TUBE WITH NIPSET CONNECTOR INFANT	Each	13.50
CA102N	CUFFI CUFF SINGLE TUBE WITH NIPSET CONNECTOR CHILD	Each	14.00
CA103N	CUFFI CUFF SINGLE TUBE WITH NIPSET CONNECTOR SMALL ADULT	Each	14.50
CA104N	CUFFI CUFF SINGLE TUBE WITH NIPSET CONNECTOR ADULT	Each	15.00
CA105N	CUFFI CUFF SINGLE TUBE WITH NIPSET CONNECTOR ADULT LONG	Each	16.00
CA106N	CUFFI CUFF SINGLE TUBE WITH NIPSET CONNECTOR LARGE ADULT	Each	16.00
CA107N	CUFFI CUFF SINGLE TUBE WITH NIPSET CONNECTOR THIGH	Each	18.00



Section 01 - Blood Pressure

Accoson Reusable Two-Piece Blood Pressure Cuffs



These comfortable, stain-resistant, latex-free cuffs are available with single or double tube and supplied with hook and loop fastenings. Connectors are available for any type of NIBP device and can be found on page 9.



Cuff with double-tube inflation bag

Size	Pack	Hook and Loop Cuff Complete		Inflation Bag Only	
		Cat No	Price	Cat No	Price
Standard Adult (228mm x 127mm)	Each	AC1321	8.15	AC1021	2.65
WR Alternative Adult (354mm x 127mm)	Each	AC1322	11.50	AC1022	5.10
Large Adult (381mm x 178mm)	Each	AC1323	17.90	AC1023	6.70
Child (191mm x 102mm)	Each	AC1324	6.40	AC1024	2.45
Small Child (152mm x 76mm)	Each	AC1325	6.40	AC1025	2.45
Infant (102mm x 51mm)	Each	AC1326	6.40	AC1026	2.45
Newborn (102mm x 25mm)	Each	AC1327	6.40	AC1027	2.45
Thigh (508mm x 178mm)	Each	AC1328	19.95	AC1028	7.35
Alternative Child (180mm x 80mm)	Each	AC1329	6.40	AC1029	2.45
Alternative Small Child (130mm x 40mm)	Each	AC1330	6.40	AC1030	2.45

Cuff with single-tube inflation bag

Size	Pack	Hook and Loop Cuff Complete		Inflation Bag Only	
		Cat No	Price	Cat No	Price
Standard Adult (228mm x 127mm)	Each	AC1311	8.15	AC1011	2.65
WR Alternative Adult (354mm x 127mm)	Each	AC1312	11.50	AC1012	5.10
Large Adult (381mm x 178mm)	Each	AC1313	17.90	AC1013	6.70
Child (191mm x 102mm)	Each	AC1314	6.40	AC1014	2.45
Small Child (152mm x 76mm)	Each	AC1315	6.40	AC1015	2.45
Infant (102mm x 51mm)	Each	AC1316	6.40	AC1016	2.45
Newborn (102mm x 25mm)	Each	AC1317	6.40	AC1017	2.45
Thigh (508mm x 178mm)	Each	AC1318	19.95	AC1018	7.35
Alternative Child (180mm x 80mm)	Each	AC1319	6.40	AC1019	2.45
Alternative Small Child (130mm x 40mm)	Each	AC1320	6.40	AC1020	2.45

Cuff only (without inflation bag)

Size	Pack	Hook and Loop Cuff Only	
		Cat No	Price
Standard Adult (228mm x 127mm)	Each	AC1301	5.50
WR Alternative Adult (354mm x 127mm)	Each	AC1302	6.40
Large Adult (381mm x 178mm)	Each	AC1303	11.20
Child (191mm x 102mm)	Each	AC1304	3.95
Small Child (152mm x 76mm)	Each	AC1305	3.95
Infant (102mm x 51mm)	Each	AC1306	3.95
Newborn (102mm x 25mm)	Each	AC1307	3.95
Thigh (508mm x 178mm)	Each	AC1308	12.60
Alternative Child (180mm x 80mm)	Each	AC1309	3.95
Alternative Small Child (130mm x 40mm)	Each	AC1310	3.95

KaWe Reusable Two-Piece Blood Pressure Cuffs

These comfortable, stain-resistant, latex-free cuffs are available with single or double tube and supplied with hook and loop fastenings. Connectors are available for any type of NIBP device and can be found on page 9.

Size	cm	Pack	Single-Tube Cuff Complete		Double-Tube Cuff Complete	
			Cat No	Price	Cat No	Price
Infant	13 - 19	Each	0485100211	8.60	0485200211	8.60
Child	17 - 26	Each	0485100221	8.60	0485200221	8.60
Adult	27 - 33	Each	0485100231	8.60	0485200231	8.60
Large Adult	31 - 47	Each	0485100241	10.42	0485200241	10.42



Section 01 - Blood Pressure

Blood Pressure Cuff Connectors



Cat No		Pack	Price
BP03	FEMALE LUER	Each	0.77
BP04	FEMALE LUER METAL	Each	4.63
BP05	MALE LUER SLIP METAL	Each	3.09
BP05P	MALE LUER SLIP	Each	0.46
BP06	MALE LUER	Each	0.77
BP07	MALE LUER METAL	Each	4.63
BP08	MALE SCREW	Each	0.77
BP09	FEMALE SCREW METAL	Each	3.09
BP09P	FEMALE SCREW PLASTIC	Each	0.62
BP12	MALE BAYONET METAL	Each	1.55
BP12P	MALE BAYONET PLASTIC	Each	0.77
BP15	FEMALE BAYONET METAL	Each	6.18
BP16	BAYONET METAL MONITOR PLUG	Each	6.18
BP17	MALE QUICK LOCK	Each	1.55
BP18	FEMALE QUICK LOCK	Each	1.55
BP20	FEMALE LUER SLIP METAL	Each	3.09
BP21	MALE PACETECH	Each	1.55
BP22	GE MONITOR PLUG	Each	7.72
BP24	GE MONITOR PLUG	Each	7.72
BP25	GE MONITOR PLUG	Each	7.72
BP26	FEMALE NEONATAL HOSE	Each	3.09
BP27	FEMALE NEONATAL HOSE	Each	3.09

Cat No		Pack	Price
BP28	DOUBLE TUBE HOSE INTERNAL	Each	3.09
BP30	NIHON KOHDEN MONITOR PLUG	Each	10.80
BP30A	NIHON KOHDEN MONITOR PLUG	Each	10.80
BP31	MALE LUER METAL	Each	4.63
BP32	FEMALE LUER METAL	Each	4.63
BP34	METAL LUER CONNECTOR MALE	Each	3.09
BP35	METAL LUER CONNECTOR FEMALE	Each	3.09
BP40	DRAEGER MONITOR PLUG	Each	13.89
BP2TM	DOUBLE-ENDED PUSH METAL	Each	1.55
BP2TP	DOUBLE-ENDED PUSH PLASTIC	Each	0.77
BS04	MONITOR SOCKET	Each	10.80
BS07	MONITOR SOCKET	Each	10.80
BS15	MALE BAYONET MONITOR SOCKET	Each	10.80
BS17	FEMALE QUICK LOCK MONITOR SOCKET	Each	7.72
BS21	PACETECH MONITOR SOCKET	Each	10.80
BPF250001	FEMALE BAYONET	Each	5.99
343030500	THREADED MALE	Each	0.14
302629000	THREADED FEMALE	Each	2.92
302580700	MALE LUER	Each	0.35
302583200	FEMALE LUER	Each	0.29
302615200	BAYONET MALE	Each	0.23
BP3TY	Y CONNECTOR HOSE	Each	3.09



Universal 'Y' Adaptors

Single-Tube Air Hose to Double-Tube BP Cuff

Cat No	BP3T-Y	BP3T-1718	BP3T-1717	BP3T-0909	BP3T-2T2T	BP3T-2020
Price Code	A3	A6	A6	A8	A5	A8
Cat No	BP12-3T	BP12-1718	BP12-1717	BP12-0909	BP12-2T2T	BP12-2020
Price Code	A5	A7	A7	B1	A6	B1
Cat No	BP18-3T	BP18-1718	BP18-1717	BP18-0909	BP18-2T2T	BP18-2020
Price Code	A5	A7	A7	B1	A6	B1
Cat No	BP04-3T	BP04-1718	BP04-1717	BP04-0909	BP04-2T2T	BP04-2020
Price Code	A7	B1	B1	B3	A8	B3
Cat No	BP08-3T	BP08-1718	BP08-1717	BP08-0909	BP08-2T2T	BP08-2020
Price Code	A4	A7	A7	B1	A6	B1
Cat No	BP2T-3T	BP2T-1718	BP2T-1717	BP2T-0909	BP2T-2T2T	BP2T-2020
Price Code	A4	A7	A7	B1	A6	B1
Cat No	BP21-3T	BP21-1718	BP21-1717	BP21-0909	BP21-2T2T	BP21-2020
Price Code	A5	A7	A7	B1	A6	B1

With universal Y adaptors you can convert your existing double-tube hoses to use single-hose cuffs or vice-versa. This allows you to standardise on a single-cuff adaptor regardless of your monitoring inventory, offering space and cost savings. They also allow you to standardise on readily available connectors, therefore not tying you to specific brands.



Price Code	Price Per	Price
A3	Each	3.09
A4	Each	3.86
A5	Each	4.63
A6	Each	6.18
A7	Each	7.72
A8	Each	9.26
B1	Each	10.80
B2	Each	12.35
B3	Each	13.89
B4	Each	15.43

Double-Tube Air Hose to Single-Tube BP Cuff

Cat No	BP3T-Y	BP15-3T	BP04-3T	BP18-3T	BP2T-3T	BP20-3T
Price Code	A3	A8	A7	A5	A4	A6
Cat No	BP3T-1718	BP15-1718	BP04-1718	BP18-1718	BP2T-1718	BP20-1718
Price Code	A6	B2	B1	A7	A7	A8
Cat No	BP3T-1818	BP15-1818	BP04-1818	BP18-1818	BP2T-1818	BP20-1818
Price Code	A6	B2	B1	A7	A7	A8
Cat No	BP3T-0808	BP15-0808	BP04-0808	BP18-0808	BP2T-0808	BP20-0808
Price Code	A5	B1	A8	A6	A6	A7
Cat No	BP3T-1212	BP15-1212	BP04-1212	BP18-1212	BP2T-1212	BP20-1212
Price Code	A6	B2	B1	A7	A7	A8
Cat No	BP3T-0505	BP15-0505	BP04-0505	BP18-0505	BP2T-0505	BP20-0505
Price Code	A8	B4	B3	B1	B1	B2

Section 01 - Blood Pressure

Blood Pressure Hoses

OEM Manufacturers and Monitor Models	Tube	Monitor End Plug	Adult Cuff End Connector	Cat No Adult/ Paediatric	Price	Neonatal Cuff End Connector	Cat No Infant/Neonate	Price
Philips All except A1/A3	1			HS1516	27.78		HSN1620	33.95
Philips A1/A3, Nellcor, Siemens, Datascope, Spacelabs, Kontron, Mindray	1			HS1515	27.78		HSN1520	33.95
GE-Dinamap Pro, Compact, MPS, ProCare Series	2			HD2509	41.66		HDN2527	46.29
GE-Dinamap Pro, Compact, MPS, ProCare Series	2			HD2517	41.66		HDN2527	46.29
GE-Datex AS/3, CS/3, S/5, Cardiacap, Light	2			HD221718	41.66		HDN2227	46.29
GE-Marquette Eagle, Solar, Tram	2			HD2217	41.66		HDN2227	46.29
GE-Dash Eagle, Solar, Tram	2			HD2417	41.66		HDN2427	46.29
GE-Dash Eagle, Solar, Tram	2			HD2409	41.66		HDN2427	46.29
GE-Critikon, Invivo, Kontron, Nihon Kohden	2			HD0909	41.66		HD0927	46.29
GE-Critikon, Invivo, Kontron, Nihon Kohden	2			HD0917	41.66		HDN0927	46.29
Nihon Kohden	2			HD3018	54.00		HDN3020	60.17
Criticare, Datascope, Spacelabs, Colin, Nihon Kohden	1			HS0407	27.78		HSN0420	33.95
Colin	1			HS3132	27.78		HSN3120	33.95
Drager/Siemens SC6000 - 7000/8000/9000 Infinity	1			HS4015	54.00		HSN4020	60.17
Physio Control Lifepak 20	1			HS1215	27.78		HSN1220	33.95
MEK MP700, MP1000	1			HS0909	27.78		HSN0920	33.95
Welch Allyn Atlas	1			HS0409	27.78		HSN0420	33.95

If you don't see what you looking for please call our Customer Care team on 01707 385226



Section 01 - Blood Pressure

Accoson Sphygmomanometers - Greenlight 300™



- Replacement of mercury instruments a simple matter without disruption and without loss of accuracy.
- The accuracy of a mercury sphygmomanometer without the need for health and safety considerations.
- None of the fragility of an aneroid gauge.
- A bright, clear, large-scale display; the moving light indicates the cuff pressure.
- Clinicians retain the confidence of the Riva-Rocci/Korotkoff method of measurement, with the advantage of the following aids to improve their measuring technique:

The cuff deflation rate is displayed to help the user deflate between 2 and 3mmHg per second as recommended by the British Hypertension Society.

Display design encourages measurement to 2mmHg as recommended by the British Hypertension Society.

- Automatic pressure zero when switched on, to ensure accuracy.
- Automatic switch-off when conditions could affect accuracy.
- Extended battery life with low battery indicator. The battery compartment is accessible from the front in all versions of the instrument.
- Supplied as a portable desk model which can be converted easily to a wall-mounted or mobile stand version using the kits available.
- Supplied with coiled tubing for convenient and tidy use.
- Complies with all the applicable requirements of the European Standards for Sphygmomanometers EN 1060-1:1995, EN 1060-2:1995, EN 1060-3:1997 and IEC EN 60601-1:1988 Medical Electrical Equipment Part 1 General Requirements for Safety.

Operational range: 10°C to 40°C

Storage range: -20°C to 70°C, 0 to 100% RH

Batteries: 4 x AA/LR6 alkaline cells (not included)

Battery life (typical): 170 hours continuous use

Time from start of battery warning signal to device failure (typical): 3.5 hours continuous use

Range: -2mmHg to 300mmHg, with under-range and over-range indicators

Accuracy: Better than ± 3mmHg

Protection against electric shock: Internally powered type BF

Protection against ingress of water: IPX0

Protection against flammable anaesthetic mixtures: None



Designed and manufactured in the United Kingdom with the technical and scientific support of the Regional Medical Physics Department of Freeman Hospital and the University of Newcastle Upon Tyne.

The Greenlight 300 converts to a wall-mounted instrument when fitted with the wall conversion kit code AC1772, which consists of a swivel mounting bracket which allows the instrument to be turned in two directions. This gives easy viewing of the display, particularly when the instrument is placed between two beds, with cuff storage behind the manometer.

The Greenlight 300 converts to a mobile stand model when fitted with the stand conversion kit code AC1774, which consists of:

- A large container for the cuff and tubing onto which the instrument is fitted. This is set at an angle for easy viewing.
- An adjustable height mobile stand with five castors.

Cat No		Pack	Price
AC0702	GREENLIGHT 300 WITH ADULT VELCRO CUFF	Each	129.35
AC0709	GREENLIGHT 300 WITH WR VELCRO CUFF	Each	129.50
AC0770	GREENLIGHT 300 GAUGE ONLY	Each	118.50
AC1772	GREENLIGHT 300 WALL MODEL CONVERSION KIT	Each	22.75
AC1774	GREENLIGHT 300 STAND MODEL CONVERSION KIT	Each	67.50
AC0701	GREENLIGHT 300 CALIBRATION TEST KIT	Each	136.50
AC1775	GREENLIGHT 300 CARRYING CASE WITH ZIPPER	Each	12.50
AC1770	SET OF 4 x AA BATTERIES	Set	1.60

Accoson Sphygmomanometers - Hand-Held Models

We offer three types of hand-held sphygmomanometer - Limpet, Pocket and Duplex. All are guaranteed accurate to British Standard specification EN 1060-1. All are easy to use and the Limpet and Pocket models are suitable for both right- and left-handed people. They are all latex-free and supplied in a zipped soft pouch case.

The Limpet model is manufactured from a lightweight plastic mould.

The Pocket model is manufactured from a lightweight diecast case and is fitted with a spring clip for attachment to the cuff.

The Duplex model is manufactured from a lightweight diecast case and is fitted with an inbuilt screw valve for easy thumb and fingertip control of air release.

Duplex Model



Limpet Model



Pocket Model



Cat No	Duplex Model	Pack	Price
AC0322	VELCRO CUFF	Each	43.55
AC0329	WR HOOK AND LOOP CUFF	Each	46.05
AC0371	GAUGE ONLY	Each	27.00

Cat No	Limpet Model	Pack	Price
AC0302	VELCRO CUFF	Each	31.20
AC0309	WR HOOK AND LOOP CUFF	Each	33.70
AC0374	GAUGE ONLY	Each	20.20

Cat No	Pocket Model	Pack	Price
AC0312	VELCRO CUFF	Each	39.35
AC0319	WR HOOK AND LOOP CUFF	Each	41.85
AC0370	GAUGE ONLY	Each	23.00

Section 01 - Blood Pressure

Accoson Sphygmomanometers - six[□] Series Aneroid Models

We offer three types of Six Series aneroid sphygmomanometer - Stand, Wall and Desk. All are guaranteed accurate to ISO 81060-1 and they are 100% latex-free. The adjustable height stand model has the gauge inclined for easy viewing. The wall model features a fixed or swivel wall bracket for easy viewing and cuff storage behind the gauge. An optional hook and loop cuff allows easy, hole-free wall mounting. The desk model is fitted with a large carrying handle and cuff storage basket plus rubber feet for stability.



Cat No	Wall Model	Pack	Price
AC0642	HOOK AND LOOP CUFF	Each	54.60
AC0649	WR HOOK AND LOOP CUFF	Each	57.10
AC0672	GAUGE ONLY	Each	41.00
AC1660	OPTIONAL HOOK AND LOOP WALL MOUNTING PLATE	Each	6.50

Cat No	Stand Model	Pack	Price
AC0662	HOOK AND LOOP CUFF	Each	117.65
AC0669	WR HOOK AND LOOP CUFF	Each	120.15
AC0676	GAUGE ONLY	Each	40.00

Cat No	Desk Model	Pack	Price
AC0632	HOOK AND LOOP CUFF	Each	57.85
AC0639	WR HOOK AND LOOP CUFF	Each	60.35
AC0673	GAUGE ONLY	Each	44.50

Accoson Sphygmomanometers - 6" Aneroid Models

We offer three types of six inch aneroid sphygmomanometer - Stand, Wall and Desk. All are guaranteed accurate to British Standard specification EN 1060-1. The precision mechanism ensures smooth and reliable performance and gives immediate response to changes in cuff pressure. They are all 100% latex-free. The stand model has the gauge inclined for easy viewing and a heavy base with five castors.

The wall model features a swivel wall bracket for easy viewing and cuff storage behind the gauge. The desk model is fitted with a large carrying handle and cuff storage basket plus rubber feet for stability.

Cat No	Wall Model	Pack	Price
AC0342	HOOK AND LOOP CUFF	Each	44.85
AC0349	WR HOOK AND LOOP CUFF	Each	47.35
AC0372	GAUGE ONLY	Each	31.50

Cat No	Stand Model	Pack	Price
AC0362	HOOK AND LOOP CUFF	Each	109.20
AC0369	WR HOOK AND LOOP CUFF	Each	111.70
AC0376	GAUGE ONLY	Each	31.50

Cat No	Desk Model	Pack	Price
AC0332	HOOK AND LOOP CUFF	Each	48.10
AC0339	WR HOOK AND LOOP CUFF	Each	50.60
AC0375	GAUGE ONLY	Each	34.75



Sphygmomanometer Spare Parts

Our spare parts can be used for virtually all sphygmomanometers although we recommend that you check compatibility before purchasing.

Cat No		Pack	Price
AC1500	ACCOSON CONTROL VALVE	Each	1.20
AC1501	ACCOSON INFLATION BULB	Each	1.20
AC1502	ACCOSON INFLATION BULB WITH CONTROL VALVE	Each	2.40
AC1502M	ACCOSON INFLATION BULB WITH METAL CONTROL VALVE	Each	2.80
AC1503	ACCOSON FEMALE TUBE CONNECTOR	Each	0.18
AC1504	ACCOSON MALE TUBE CONNECTOR	Each	0.18
AC1505	ACCOSON TUBING CONNECTORS	Pair	0.36
AC1691	ACCOSON STRAIGHT TUBING 2.5M	Each	4.50
AC1703	ACCOSON LONG COILED TUBE FOR WALL/STAND MODEL	Each	6.30
AC1704	ACCOSON SHORT COILED TUBE FOR DESK MODEL	Each	4.00



Section 01 - Blood Pressure

KaWe Sphygmomanometers

KaWe offers blood pressure measuring devices that you can trust. Our blood pressure measuring devices are user-friendly and set themselves apart from others with their high quality and fair price. All KaWe MASTERMED® blood pressure measuring devices are latex-free. Our product line extends from the A1 and A1+ handheld units to the new KaWe MASTERMED® C premium blood pressure measuring device, which is available in wall-mounted, table-mounted or instrument stand models. This high quality blood pressure measuring device can also be used in combination with the KaWe MedCenter® 5000, offering you yet another option for your wall-mounted diagnostic tool set. All KaWe blood pressure measuring devices meet EC Standards 93/42/EEC (standards for medical products) and the product-specific standards DIN EN ISO 81060-1.



MASTERMED® C

The KaWe MASTERMED® C Premium blood pressure monitors provide clinicians the highest level of quality and value. The instruments in this series are defined by their innovative and practical features, smooth surfaces for easy cleaning and particularly precise gauges. These blood pressure monitoring devices are available as wall mounted, table top and freestanding models. They have a double-walled housing that ensures additional stability and protection and are therefore designed to withstand twice the pressure. Each model comes with a generously-sized cuff holder.

- Large 150mm dial, pivotal for easy viewing.
- Storage space for cuff and inflation system.
- Spiral tubing allows long working distance.
- Copper-Beryllium manometer, precise and long-lasting.
- KaWe 2 year guarantee.
- Latex-free.

Cat No		Pack	Price
0432750232	KAWE MASTERMED C WALL MODEL	Each	85.63
0432730232	KAWE MASTERMED C DESK MODEL	Each	88.14
0432740232	KAWE MASTERMED C MOBILE STAND MODEL	Each	157.74

MASTERMED® A1 & A1+

- Shock Protected.
- 58mm diameter dial.
- Attractive safe plastic housing.
- Copper-Beryllium manometer, precise and long-lasting.
- Supplied in zipped storage bag complete with standard adult cuff.
- KaWe 2 year guarantee.
- Latex-free.

0411134232 - Mastermed® A1



Cat No		Pack	Price
0411134232	KAWE MASTERMED A1 SINGLE TUBE, BLACK WITH PLASTIC RING	Each	35.25
0411144232	KAWE MASTERMED A1+ SINGLE TUBE, BLACK WITH METAL RING	Each	37.66

0411144232 - Mastermed® A1+

























Section 01 - Blood Pressure

Invasive Blood Pressure Cables

These 4-metre Invasive Blood Pressure cables are fully compatible with patient monitors and transducers from all major manufacturers. Supplied individually.



Monitor End	Cat No		Price		Cat No		Price		Cat No		Price		Cat No		Price		Cat No		Price	
	ARGON		B.BRAUN		BD		EDWARDS		MEDEX ABBOTT		MEDEX LOGICAL		PVB		UTAH					
	BCBLTAG	33.33	BCBLTBB	33.33	BCBLTBD	49.40	BCBLTED	33.33	BCBLTMX	33.33	BCBLTMX1	61.72	BCBLTPVB	33.33	BCBLTUT	33.33				
	BCCLAG	33.33	BCCLBB	33.33	BCCLBD	49.40	BCCLEED	33.33	BCCLMX	33.33	BCCLMX1	61.72	BCCLPVB	33.33	BCCLUT	33.33				
	BCCSIAG	33.33	BCCSIBB	33.33	BCCSIBD	55.55	BCCSIED	33.33	BCCSIMX	33.33	BCCSIMX1	61.72	BCCSIPVB	33.33	BCCSIUT	33.33				
	BCDTAG	33.33	BCDTBB	33.33	BCDTBD	55.55	BCDTEED	33.33	BCDTMX	33.33	BCDTMX1	61.72	BCDTPVB	33.33	BCDTUT	33.33				
	BCGRAG	33.33	BCGRBB	33.33	BCGRBD	55.55	BCGREED	33.33	BCGRMX	33.33	BCGRMX1	61.72	BCGRPVB	33.33	BCDRUT	33.33				
	BCSAG2	123.49	BCSBB2	123.49	BCSBD2	123.49	BCSEED2	123.49	BCSMX2	123.49	BCSMX12	166.63	BCSPVB2	123.49	BCSUT2	123.49				
	BCFDAG	40.74	BCFDBB	40.74	BCFDBD	70.36	BCFDEED	40.74	BCFDMX	40.74	BCFDMX1	74.06	BCFDPVB	33.33	BCFDUT	40.74				
	BCDXAG	33.33	BCDXBB	33.33	BCDXBD	55.55	BCDXED	33.33	BCDXMX	33.33	BCDXMX1	61.72	BCDXPVB	33.33	BCDXUT	33.33				
	BCHLAG	33.33	BCHLBB	33.33	BCHLBD	55.55	BCHLEED	33.33	BCHLMX	33.33	BCHLMX1	61.72	BCHLPVB	33.33	BCHLUT	33.33				
	BCMAG	33.33	BCMABB	33.33	BCMABD	55.55	BCMARED	33.33	BCMAMX	33.33	BCMAMX1	61.72	BCMAMPVB	33.33	BCMAMUT	33.33				
	BCMAG2	49.40	BCMABB2	49.40	BCMABD2	74.06	BCMARED2	49.40	BCMAMX2	49.40	BCMAMX12	98.75	BCMAMPVB2	49.40	BCMAMUT2	49.40				
	BCKTAG	33.33	BCKTBB	33.33	BCKTBD	55.55	BCKTEED	33.33	BCKTMX	33.33	BCKTMX1	61.72	BCKTPVB	33.33	BCKTUT	33.33				
	BCMAG	33.33	BCMABB	33.33	BCMABD	55.55	BCMARED	33.33	BCMAMX	33.33	BCMAMX1	61.72	BCMAMPVB	33.33	BCMAMUT	33.33				
	BCDT1AG	33.33	BCDT1BB	33.33	BCDT1BD	55.55	BCDT1ED	33.33	BCDT1MX	33.33	BCDT1MX1	61.72	BCDT1PVB	33.33	BCDT1UT	33.33				
	BCMRAG	33.33	BCMRBB	33.33	BCMRBD	55.55	BCMREED	33.33	BCMRMX	33.33	BCMRMX1	61.72	BCMRPVB	33.33	BCMRUT	33.33				
	BCNK1AG	33.33	BCNK1BB	33.33	BCNK1BD	55.55	BCNK1ED	33.33	BCNK1MX	33.33	BCNK1MX1	61.72	BCNK1PVB	33.33	BCNK1UT	33.33				
	BCNK2AG	55.55	BCNK2BB	55.55	BCNK2BD	74.06	BCNK2ED	33.33	BCNK2MX	55.55	BCNK2MX1	61.72	BCNK2PVB	49.40	BCNK2UT	55.55				
	BCHPAG	33.33	BCHPBB	33.33	BCHPBD	55.55	BCHPED	33.33	BCHPMX	33.33	BCHPMX1	61.72	BCHPPVB	33.33	BCHPUT	33.33				
	BCSM1AG	33.33	BCSM1BB	33.33	BCSM1BD	55.55	BCSM1ED	33.33	BCSM1MX	33.33	BCSM1MX1	61.72	BCSM1PVB	33.33	BCSM1UT	33.33				
	BCSM2AG	33.33	BCSM2BB	33.33	BCSM2BD	55.55	BCSM2ED	33.33	BCSM2MX	33.33	BCSM2MX1	61.72	BCSM2PVB	33.33	BCSM2UT	33.33				
	BC6PAG	24.69	BC6PBB	24.69	BC6PBD	55.55	BC6PED	33.33	BC6PMX	24.69	BC6PMX1	61.72	BC6PPVB	24.69	BC6PUT	24.69				
	BCSLAG	40.74	BCSLBB	40.74	BCSLBD	61.72	BCSLED	40.74	BCSLMX	40.74	BCSLMX1	61.72	BCSLPVB	40.74	BCSLUT	40.74				
	BCSKAG	49.40	BCSKBB	49.40	BCSKBD	74.06	BCSKED	49.40	BCSKMX	49.40	BCSKMX1	61.72	BCSKPVB	49.40	BCSKUT	49.40				



Section 01 - Blood Pressure

Invasive Blood Pressure Cable Adaptors

These 0.3m cables adapt your GE Marquette, Mindray/Datascope, Siemens and/or Spacelabs monitors to accept either one or two alternative invasive blood pressure cables. Supplied individually.



BCMAD2

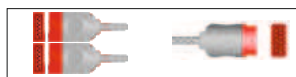

BCMQM2

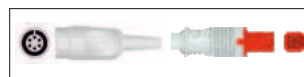

BCDT1AD

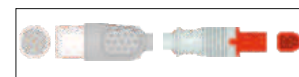

BCDT1DT



BCMRAD



BCSLAD

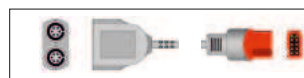

BCSLAD2



BCSSM12



BCSSM22



BCSM2SM12



BCSM2SM2



BCSM2SM1

Cat No	Monitor End	Cable End	Pack	Price
BCMAD2	GE MARQUETTE	SPACELABS/GENERAL (x2)	Each	74.06
BCMQM2	GE MARQUETTE	GE MARQUETTE (x2)	Each	123.43
BCDT1AD	MINDRAY/DATASCOPE	SPACELABS/GENERAL	Each	33.33
BCDT1DT	MINDRAY/DATASCOPE	MINDRAY/DATASCOPE	Each	33.33
BCMRAD	MINDRAY/DATASCOPE	SPACELABS/GENERAL	Each	33.33
BCSLAD	SPACELABS	SPACELABS/GENERAL	Each	61.72

Cat No	Monitor End	Cable End	Pack	Price
BCSLAD2	SPACELABS	SPACELABS/GENERAL (x2)	Each	74.06
BCSSM12	SIEMENS/DRAEGER	SIEMENS 10PIN (x2)	Each	166.63
BCSSM22	SIEMENS/DRAEGER	SIEMENS 7PIN (x2)	Each	166.63
BCSM2SM12	SIEMENS/DRAEGER	SIEMENS 10PIN (x2)	Each	123.43
BCSM1SM2	SIEMENS/DRAEGER	SIEMENS 7PIN	Each	33.33
BCSM2SM1	SIEMENS/DRAEGER	SIEMENS 10PIN	Each	33.33

Invasive Blood Pressure Transducers

Intended for arterial and venous blood pressure monitoring and blood sample testing, these disposable invasive blood pressure transducers are available with five types of popular connector.

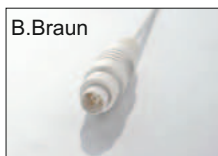

B.Braun

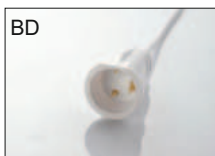

BD



Edwards



Medex



Utah

Connector	Standard Lock Connector	Sensitivity	5.0µv/v/mmHg±5%
Flush Speed	≥3ml±1ml/1h/300mmHg	Leakage Current	<10µA
Pressure Measurement Range	-50~300mmHg	Marker	Artery-Red, Venous-Blue

Single Channel Sets



Cat No	Connector	Channel	Pack	Price
DPBB	B.BRAUN	SINGLE	50	680.00
DPBD	BD	SINGLE	50	680.00
DPED	EDWARDS	SINGLE	50	680.00
DPMX	MEDEX	SINGLE	50	680.00
DPUT	UTAH	SINGLE	50	680.00

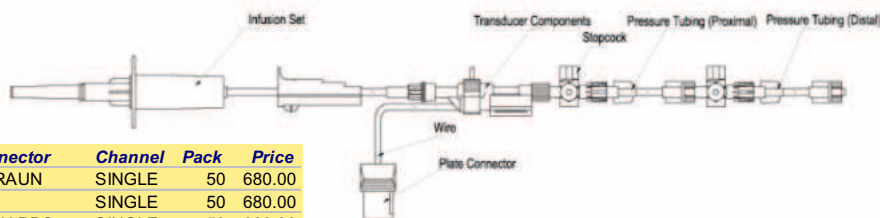

Double Channel Sets

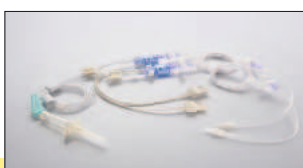

Cat No	Connector	Channel	Pack	Price
DPBB2	B.BRAUN	DOUBLE	50	1358.00
DPBD2	BD	DOUBLE	50	1358.00
DPED2	EDWARDS	DOUBLE	50	1358.00
DPMX2	MEDEX	DOUBLE	50	1358.00
DPUT2	UTAH	DOUBLE	50	1358.00

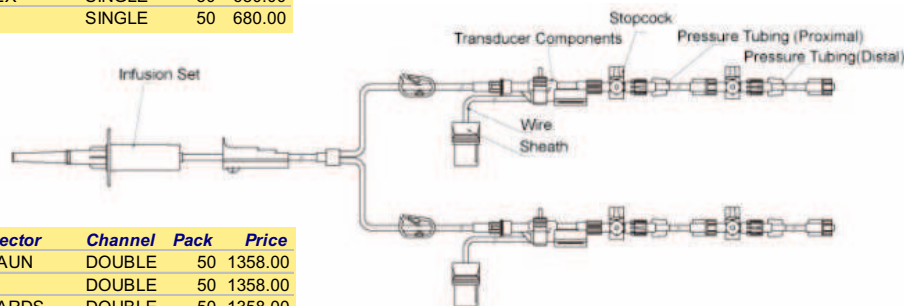

Triple Channel Sets



Cat No	Connector	Channel	Pack	Price
DPBB3	B.BRAUN	TRIPLE	50	2037.00
DPBD3	BD	TRIPLE	50	2037.00
DPED3	EDWARDS	TRIPLE	50	2037.00
DPMX3	MEDEX	TRIPLE	50	2037.00
DPUT3	UTAH	TRIPLE	50	2037.00

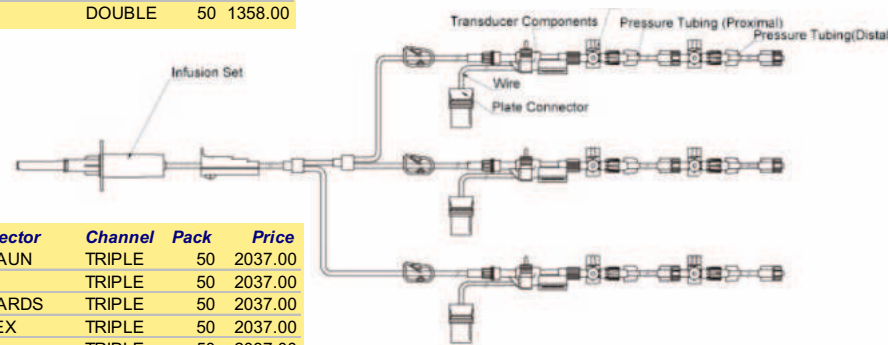

Section 02 - Thermometry

YSI-Compatible Disposable Temperature Probes & Reusable Instrument Cables

Affordable and economical alternatives to reusable probes. A reusable, cleanable instrument cable attaches to the monitor and sterile disposable probes attach to the cable.



Cat No		Pack	Price
4491H	400 SERIES DISPOSABLE TEMPERATURE PROBE - GENERAL PURPOSE 9FR	50	200.00
4499H	400 SERIES DISPOSABLE TEMPERATURE PROBE - SKIN SURFACE	50	164.00
4791H	700 SERIES DISPOSABLE TEMPERATURE PROBE - GENERAL PURPOSE 9FR	25	85.00
Cat No		Pack	Price
400H	400 SERIES REUSABLE INSTRUMENT CABLE 365cm (12ft)	Each	18.00
400HS	400 SERIES REUSABLE INSTRUMENT CABLE 365cm (12ft) - SIEMENS	Each	18.00
400HHP	400 SERIES REUSABLE INSTRUMENT CABLE 365cm (12ft) - PHILIPS/HP	Each	18.00

Hydrogel Temperature Probe Covers

Our highly comfortable temperature probe covers are designed with sensitive skin in mind. A special hydrogel formula eliminates skin damage when removing or repositioning. The reflective gold insulator serves as a superior barrier against ambient and radiant heat, thus providing maximum temperature reading accuracy. Packs contain approx 100 teddy-shape covers and 100 duck-shape covers.



Cat No		Pack	Price
IPC1	PROBE COVERS SMALL 28 x 25mm (100 TEDDIES, 100 DUCKS)	200	59.00
IPC2	PROBE COVERS LARGE 40 x 34mm (100 TEDDIES, 100 DUCKS)	200	62.00

Temperature Probe Covers & Sheaths



Cat No		Pack	Price	10+
83273	TEMPORAL ORAL MERCURY THERMOMETER SHEATH	1000	13.30	12.35
R616100	DISPOSABLE LATEX SHEATHS FOR YSI401 & 701	100	116.20	
T00412	DISPOSABLE TEMPERATURE PROBE COVER	12	2.47	
TEMP4009	YSI TEMPHEARTS STANDARD	100	32.50	
4012	YSI MINI TEMPHEARTS	100	32.40	
PC600	WELCH ALLYN PROBE COVERS FOR SURETEMP	1000	35.00	

Reusable Temperature Adaptor Cables

Cat No	Monitor	Type	Length	Pack	Price
TSWAD	ARTEMA S&W	YSI 400	0.3m	Each	33.33
TBLTAD	BIOLIGHT	YSI 400	0.3m	Each	33.33
TDTAD	DATASCOPE	YSI 400	0.3m	Each	33.33
TOHAD	GE DATEX-OHMEDA	YSI 400	0.3m	Each	33.33
TMQAD	GE MARQUETTE	YSI 400	0.3m	Each	33.33
TMQ400AD2	GE MARQUETTE	YSI 400	0.3m	Each	74.06
TMQ700AD2	GE MARQUETTE	YSI 700	0.3m	Each	74.06
THPAD	PHILIPS	YSI 400	0.3m	Each	33.33
TMRAD	MINDRAY	YSI 400	0.3m	Each	33.33
TSMAD	SIEMENS	YSI 400	0.3m	Each	33.33
TSLAD	SPACELABS	YSI 400	0.3m	Each	40.74
TSLAD2	SPACELABS	YSI 400/700	0.3m	Each	74.06

These 0.3m cables allow you to convert YSI 400 or 700 series jack plug temperature probes to be compatible with OEM monitors.



Original YSI 400 & 700 Series Reusable Temperature Probes

A range of reusable temperature probes compatible with YSI 400 and 700 series-enabled monitors.

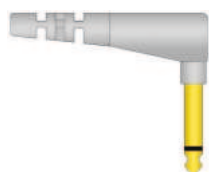

Cat No	Series	Type	Pack	Price
YSI401	400	ADULT GENERAL PURPOSE	Each	47.00
YSI402	400	PAEDIATRIC GENERAL PURPOSE	Each	67.00
403	400	ADULT STAINLESS STEEL TUBULAR	Each	96.00
408	400	BANJO SURFACE	Each	127.00
YSI409A	400	ADULT SKIN	Each	96.00
YSI409B	400	ADULT SKIN	Each	79.00
427	400	PAEDIATRIC SKIN	Each	116.00
441	400	AIRWAY	Each	96.00
401AC	400	ADULT GENERAL PURPOSE AUTOCLAVABLE	Each	54.00
402AC	400	PAEDIATRIC GENERAL PURPOSE AUTOCLAVABLE	Each	67.00
409AC	400	ADULT SKIN AUTOCLAVABLE	Each	75.50
701	700	ADULT GENERAL PURPOSE	Each	96.00
702	700	PAEDIATRIC GENERAL PURPOSE	Each	124.00
708	700	BANJO SURFACE	Each	154.00
YSI709A	700	ADULT SKIN	Each	127.00
YSI709B	700	ADULT SKIN	Each	111.00

Reusable Temperature Probes

A range of reusable temperature probes compatible with various OEM monitoring systems.

Cat No	Monitor	Type	Length	Pack	Price
TAS15AS	AIRSHIELD	ADULT SKIN	1.5m	Each	37.03
TAS15AG	AIRSHIELD	ADULT GENERAL PURPOSE	1.5m	Each	37.03
TAS15PS	AIRSHIELD	PAEDIATRIC SKIN	1.5m	Each	37.03
TAS15PG	AIRSHIELD	PAEDIATRIC GENERAL PURPOSE	1.5m	Each	37.03
TSWAS	ARTEMA S&W	ADULT SKIN	3.0m	Each	37.03
TSWAG	ARTEMA S&W	ADULT GENERAL PURPOSE	3.0m	Each	37.03
TSWPS	ARTEMA S&W	PAEDIATRIC SKIN	3.0m	Each	37.03
TSWPG	ARTEMA S&W	PAEDIATRIC GENERAL PURPOSE	3.0m	Each	37.03
TAT15PS	ATOM	PAEDIATRIC SKIN	1.5m	Each	37.03
TBLTAS	BIOLIGHT	ADULT SKIN	3.0m	Each	33.33
TBLTAG	BIOLIGHT	ADULT GENERAL PURPOSE	3.0m	Each	33.33
TBLTPS	BIOLIGHT	PAEDIATRIC SKIN	3.0m	Each	37.03
TBLTPG	BIOLIGHT	PAEDIATRIC GENERAL PURPOSE	3.0m	Each	37.03
TDTAS	DATASCOPE	ADULT SKIN	3.0m	Each	37.03
TDTAG	DATASCOPE	ADULT GENERAL PURPOSE	3.0m	Each	37.03
TDTPS	DATASCOPE	PAEDIATRIC SKIN	3.0m	Each	40.74
TDTPG	DATASCOPE	PAEDIATRIC GENERAL PURPOSE	3.0m	Each	40.74
TOHAS	GE DATEX-OHMEDA	ADULT SKIN	3.0m	Each	37.03
TOHAG	GE DATEX-OHMEDA	ADULT GENERAL PURPOSE	3.0m	Each	37.03
TOHPS	GE DATEX-OHMEDA	PAEDIATRIC SKIN	3.0m	Each	37.03
TOHPG	GE DATEX-OHMEDA	PAEDIATRIC GENERAL PURPOSE	3.0m	Each	37.03
TMQAS	GE MARQUETTE	ADULT SKIN	3.0m	Each	37.03
TMQAG	GE MARQUETTE	ADULT GENERAL PURPOSE	3.0m	Each	37.03
TMQ2AS	GE MARQUETTE	ADULT SKIN (2)	3.0m	Each	61.72
TMQASAG	GE MARQUETTE	ADULT SKIN & GENERAL PURPOSE	3.0m	Each	61.72
TMQPS	GE MARQUETTE	PAEDIATRIC SKIN	3.0m	Each	37.03
TMQPG	GE MARQUETTE	PAEDIATRIC GENERAL PURPOSE	3.0m	Each	37.03
THPAS	PHILIPS	ADULT SKIN	3.0m	Each	37.03
THPAG	PHILIPS	ADULT GENERAL PURPOSE	3.0m	Each	37.03
THPPS	PHILIPS	PAEDIATRIC SKIN	3.0m	Each	37.03
THPPG	PHILIPS	PAEDIATRIC GENERAL PURPOSE	3.0m	Each	37.03
TMRAS	MINDRAY	ADULT SKIN	3.0m	Each	37.03
TMRAG	MINDRAY	ADULT GENERAL PURPOSE	3.0m	Each	37.03
TMRPS	MINDRAY	PAEDIATRIC SKIN	3.0m	Each	37.03
TMRPG	MINDRAY	PAEDIATRIC GENERAL PURPOSE	3.0m	Each	37.03
TSM15AS	SIEMENS/DRAEGER	ADULT SKIN	1.5m	Each	37.03
TSMAS	SIEMENS/DRAEGER	ADULT SKIN	3.0m	Each	37.03
TSM15AG	SIEMENS/DRAEGER	ADULT GENERAL PURPOSE	1.5m	Each	37.03
TSMAG	SIEMENS/DRAEGER	ADULT GENERAL PURPOSE	3.0m	Each	37.03
TSM15PS	SIEMENS/DRAEGER	PAEDIATRIC SKIN	1.5m	Each	40.74
TSMPS	SIEMENS/DRAEGER	PAEDIATRIC SKIN	3.0m	Each	40.74
TSM15PG	SIEMENS/DRAEGER	PAEDIATRIC GENERAL PURPOSE	1.5m	Each	40.74
TSMPG	SIEMENS/DRAEGER	PAEDIATRIC GENERAL PURPOSE	3.0m	Each	40.74
TSLAS	SPACELABS	ADULT SKIN	3.0m	Each	48.14
TSLAG	SPACELABS	ADULT GENERAL PURPOSE	3.0m	Each	48.14
TSL2AS	SPACELABS	ADULT SKIN (2)	3.0m	Each	74.06
TSLASAG	SPACELABS	ADULT SKIN & GENERAL PURPOSE	3.0m	Each	74.06
TSLPS	SPACELABS	PAEDIATRIC SKIN	3.0m	Each	49.40
TSLPG	SPACELABS	PAEDIATRIC GENERAL PURPOSE	3.0m	Each	49.40
T2252AS	YSI 400	ADULT SKIN	3.0m	Each	17.28
T2252AG	YSI 400	ADULT GENERAL PURPOSE	3.0m	Each	17.28
T700AS	YSI 700	ADULT SKIN	3.0m	Each	33.33
T700AG	YSI 700	ADULT GENERAL PURPOSE	3.0m	Each	33.33
T10AS	YSI 10k @ 25°C	ADULT SKIN	3.0m	Each	17.28
T10AG	YSI 10k @ 25°C	ADULT GENERAL PURPOSE	3.0m	Each	17.28
T2252PS	YSI 400	PAEDIATRIC SKIN	3.0m	Each	17.28
T2252PG	YSI 400	PAEDIATRIC GENERAL PURPOSE	3.0m	Each	17.28
T700PS	YSI 700	PAEDIATRIC SKIN	3.0m	Each	33.33
T700PG	YSI 700	PAEDIATRIC GENERAL PURPOSE	3.0m	Each	33.33
T10PS	YSI 10k @ 25°C	PAEDIATRIC SKIN	3.0m	Each	17.28
T10PG	YSI 10k @ 25°C	PAEDIATRIC GENERAL PURPOSE	3.0m	Each	17.28
T100GP	AIR TEMPERATURE	FOR HUMIDIFICATION USE	3.0m	Each	37.03



Section 03 - ECG Monitoring

ECG Monitors

- Digital isolation technology minimises signal interference.
- Wide screen LCD with 3-lead waveform display.
- Optional rhythm lead detection for observing abnormal heart rate.
- Built-in rechargeable battery, AC/DC supply.
- Automatic power off.
- Adjustable base line width.
- High resolution thermal array printer.
- ECG data and waveforms store and recall.



<u>Cat No</u>		<u>Pack</u>	<u>Price</u>
UB101G	3-CHANNEL ECG MACHINE WITH LCD SCREEN	Each	575.00



- 7" 800x480 high contrast colour TFT screen.
- 3+R, 6+R, 12+R waveform display.
- High resolution thermal array printer.
- Histogram and trend chart for R-R interval analysis.
- RS232 interface for connection to workstation.
- ECG data and waveforms store and recall.

<u>Cat No</u>		<u>Pack</u>	<u>Price</u>
UB300G	3-CHANNEL ECG MACHINE WITH COLOUR TFT SCREEN	Each	975.00

- 5.7" high contrast LCD display for 12 waveforms.
- R-R interval analysis.
- Economy mode available to reduce printing cost.
- High capacity Li-ion battery offers up to 2hrs continuous power.
- Multiple language options.
- RS232 interface for connection to workstation.
- Internal memory for up to 2Gb of data.



<u>Cat No</u>		<u>Pack</u>	<u>Price</u>
UB1200	12-CHANNEL ECG MACHINE WITH LCD SCREEN	Each	1750.00



Section 03 - ECG Monitoring

3-Lead & 5-Lead ECG Cables

AAMI
Without resistors



Cable Type	3-Lead			5-Lead		
	Cat No	Pack	Price	Cat No	Pack	Price
VR TRUNK	SM2340I	Each	30.86	SM2540I	Each	43.20
DIN TRUNK	D1340I	Each	27.16	D1540I	Each	30.86
MOULDED WITH PRESS STUDS	2340SI	Each	27.16	2540SI	Each	30.86
MOULDED WITH PINCH CLAMPS	2340PI	Each	27.16	2540PI	Each	30.86

AAMI
With 1K resistors



Cable Type	3-Lead			5-Lead		
	Cat No	Pack	Price	Cat No	Pack	Price
VR TRUNK	SM2340RI	Each	30.86	SM2540RI	Each	43.20
DIN TRUNK	D1340RI	Each	27.16	D1540RI	Each	30.86
MOULDED WITH PRESS STUDS	2340RSI	Each	27.16	2540RSI	Each	30.86
MOULDED WITH PINCH CLAMPS	2340RPI	Each	27.16	2540RPI	Each	30.86

AAMI
LL style



Cable Type	3-Lead			5-Lead		
	Cat No	Pack	Price	Cat No	Pack	Price
OEM TRUNK	LL1340I	Each	43.20	LL1540I	Each	43.20
VR TRUNK	SM2340I	Each	30.86	SM2540I	Each	43.20
DIN TRUNK	D1340I	Each	27.16	D1540I	Each	30.86
MOULDED WITH PRESS STUDS	2340SI	Each	27.16	2540SI	Each	30.86
MOULDED WITH PINCH CLAMPS	2340PI	Each	27.16	2540PI	Each	30.86

Artema S&W
8000, Diascope1-2-NT,
Athena



Cable Type	3-Lead			5-Lead		
	Cat No	Pack	Price	Cat No	Pack	Price
VR TRUNK	SM2397IH	Each	43.20	SM2597IH	Each	43.20
DIN TRUNK	D1397IH	Each	37.03	D1597IH	Each	43.20
MOULDED WITH PRESS STUDS	2397SIH	Each	37.03			
MOULDED WITH PINCH CLAMPS	2397PIH	Each	37.03			

BCI



Cable Type	3-Lead			5-Lead		
	Cat No	Pack	Price	Cat No	Pack	Price
VR TRUNK	SM2340I	Each	30.86	SM2540I	Each	43.20
DIN TRUNK	D1340I	Each	27.16	D1540I	Each	30.86
MOULDED WITH PRESS STUDS	2340SI	Each	27.16	2540SI	Each	30.86
MOULDED WITH PINCH CLAMPS	2340PI	Each	27.16	2540PI	Each	30.86

Biolight
M7000, M9500, AS
Modular



Cable Type	3-Lead			5-Lead		
	Cat No	Pack	Price	Cat No	Pack	Price
DIN TRUNK				D2557I	Each	43.20
MOULDED WITH PRESS STUDS				2557SI	Each	43.20
MOULDED WITH PINCH CLAMPS				2557PI	Each	43.20

Bionet



Cable Type	3-Lead			5-Lead		
	Cat No	Pack	Price	Cat No	Pack	Price
DIN TRUNK				D2514I	Each	43.20
MOULDED WITH PRESS STUDS	2314SI	Each	37.03	2514SI	Each	43.20
MOULDED WITH PINCH CLAMPS	2314PI	Each	37.03	2514PI	Each	43.20

Biosys



Cable Type	3-Lead			5-Lead		
	Cat No	Pack	Price	Cat No	Pack	Price
DIN TRUNK	D1335I	Each	37.03			
MOULDED WITH PRESS STUDS	2335SI	Each	37.03			
MOULDED WITH PINCH CLAMPS	2335PI	Each	37.03			

CAS Medical



Cable Type	3-Lead			5-Lead		
	Cat No	Pack	Price	Cat No	Pack	Price
DIN TRUNK	D1339IH	Each	37.03			
MOULDED WITH PRESS STUDS	2339SIH	Each	37.03			
MOULDED WITH PINCH CLAMPS	2339PIH	Each	37.03			

Colin/Omron
BP308/308E/408



Cable Type	3-Lead			5-Lead		
	Cat No	Pack	Price	Cat No	Pack	Price
VR TRUNK	SM2340I	Each	30.86	SM2540I	Each	43.20
DIN TRUNK	D1340I	Each	27.16	D1540I	Each	30.86
MOULDED WITH PRESS STUDS	2340SI	Each	27.16	2540SI	Each	30.86
MOULDED WITH PINCH CLAMPS	2340PI	Each	27.16	2540PI	Each	30.86

Colin/Omron
BP88S



Cable Type	3-Lead			5-Lead		
	Cat No	Pack	Price	Cat No	Pack	Price
DIN TRUNK	D1320I	Each	37.03	D1520I	Each	40.74
MOULDED WITH PRESS STUDS	2320SI	Each	37.03	2520SI	Each	40.74
MOULDED WITH PINCH CLAMPS	2320PI	Each	37.03	2520PI	Each	40.74

Colin/Omron
BP88, BP306



Cable Type	3-Lead			5-Lead		
	Cat No	Pack	Price	Cat No	Pack	Price
DIN TRUNK	D1321I	Each	37.03			
MOULDED WITH PRESS STUDS	2321SI	Each	37.03			
MOULDED WITH PINCH CLAMPS	2321PI	Each	37.03			

Criticare
602A-A, Poet2, 504US,
Scholar



Cable Type	3-Lead			5-Lead		
	Cat No	Pack	Price	Cat No	Pack	Price
VR TRUNK	SM2340RI	Each	30.86	SM2540RI	Each	43.20
DIN TRUNK	D1340RI	Each	27.16	D1540RI	Each	30.86
MOULDED WITH PRESS STUDS	2340RSI	Each	27.16	2540RSI	Each	30.86
MOULDED WITH PINCH CLAMPS	2340RPI	Each	27.16	2540RPI	Each	30.86

Criticare
506, 507, 508, 1100,
1508, 8100



Cable Type	3-Lead			5-Lead		
	Cat No	Pack	Price	Cat No	Pack	Price
VR TRUNK	SM2340I	Each	30.86	SM2540I	Each	43.20
DIN TRUNK	D1340I	Each	27.16	D1540I	Each	30.86
MOULDED WITH PRESS STUDS	2340SI	Each	27.16	2540SI	Each	30.86
MOULDED WITH PINCH CLAMPS	2340PI	Each	27.16	2540PI	Each	30.86

Section 03 - ECG Monitoring

3-Lead & 5-Lead ECG Cables

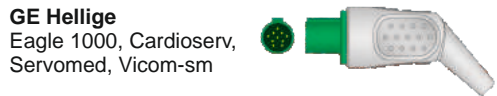
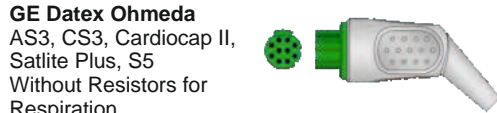
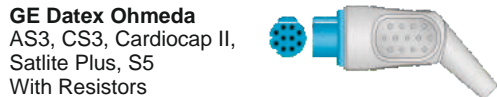

Cable Type	3-Lead			5-Lead		
	Cat No	Pack	Price	Cat No	Pack	Price
DIN TRUNK	D1330I	Each	27.16	D1530I	Each	30.86
MOULDED WITH PRESS STUDS	2330SI	Each	27.16	2530SI	Each	30.86
MOULDED WITH PINCH CLAMPS	2330PI	Each	27.16	2530PI	Each	30.86
DIN TRUNK	SM2340I	Each	30.86	SM2540I	Each	43.20
MOULDED WITH PRESS STUDS	D1340I	Each	27.16	D1540I	Each	30.86
MOULDED WITH PINCH CLAMPS	2340SI	Each	27.16	2540SI	Each	30.86
	2340PI	Each	27.16	2540PI	Each	30.86
OEM TRUNK				DT2526I	Each	43.20
DIN TRUNK				D1526I	Each	43.20
MOULDED WITH PRESS STUDS				2526SI	Each	43.20
MOULDED WITH PINCH CLAMPS				2526PI	Each	43.20
DIN TRUNK	D1377I	Each	37.03			
MOULDED WITH PRESS STUDS	2377SI	Each	37.03			
MOULDED WITH PINCH CLAMPS	2377PI	Each	37.03			
OEM TRUNK	SM2399I	Each	43.20	SM2599I	Each	43.20
VR TRUNK	SM2399I	Each	43.20	SM2599I	Each	43.20
DIN TRUNK				D1599I	Each	43.20
MOULDED WITH PRESS STUDS				2599SI	Each	43.20
MOULDED WITH PINCH CLAMPS	2399PI	Each	37.03	2599PI	Each	43.20
OEM TRUNK				SM2559I	Each	43.20
VR TRUNK				SM2559I	Each	43.20
DIN TRUNK				D1559I	Each	43.20
MOULDED WITH PRESS STUDS				2559SI	Each	43.20
MOULDED WITH PINCH CLAMPS				2559PI	Each	43.20
OEM TRUNK	DX2340RI	Each	43.20			
VR TRUNK	SM2340RI	Each	30.86	SM2540RI	Each	30.86
DIN TRUNK	D1340RI	Each	27.16	D1540RI	Each	30.86
MOULDED WITH PRESS STUDS	2340RSI	Each	27.16	2540RSI	Each	30.86
MOULDED WITH PINCH CLAMPS	2340RPI	Each	27.16	2540RPI	Each	30.86
OEM TRUNK	DX2395I	Each	43.20	DX2595I	Each	43.20
VR TRUNK	SM2395IH	Each	43.20	SM2595I	Each	43.20
DIN TRUNK	D1395I	Each	37.03	D1595I	Each	43.20
MOULDED WITH PRESS STUDS	2395SI	Each	37.03	2595SI	Each	43.20
MOULDED WITH PINCH CLAMPS	2395PI	Each	37.03	2595PI	Each	43.20
OEM TRUNK	DX2392I	Each	43.20	DX2592I	Each	43.20
VR TRUNK	SM2392I	Each	43.20	SM2592I	Each	43.20
DIN TRUNK	D1392I	Each	37.03	D1592I	Each	43.20
MOULDED WITH PRESS STUDS	2392SI	Each	37.03	2592SI	Each	43.20
MOULDED WITH PINCH CLAMPS	2392PI	Each	37.03	2592PI	Each	43.20
OEM TRUNK	DX2355I	Each	43.20	DX2555I	Each	43.20
VR TRUNK	SM2355I	Each	43.20	SM2555I	Each	43.20
DIN TRUNK	D1355I	Each	37.03	D1555I	Each	43.20
MOULDED WITH PRESS STUDS	2355SI	Each	37.03	2555SI	Each	43.20
MOULDED WITH PINCH CLAMPS	2355PI	Each	37.03	2555PI	Each	43.20
OEM TRUNK				MQ2584I	Each	43.20
VR TRUNK				SM2584I	Each	43.20
DIN TRUNK				D1584I	Each	43.20
MOULDED WITH PRESS STUDS				2584SI	Each	43.20
MOULDED WITH PINCH CLAMPS				2584PI	Each	43.20
OEM TRUNK	MQ2586I	Each	43.20	MQ2586I	Each	43.20
VR TRUNK	SM2386I	Each	43.20	SM2586I	Each	43.20
DIN TRUNK	D1386I	Each	37.03	D1586I	Each	43.20
MOULDED WITH PRESS STUDS	2386SI	Each	37.03	2586SI	Each	43.20
MOULDED WITH PINCH CLAMPS	2386PI	Each	37.03	2586PI	Each	43.20
OEM TRUNK	MQA2382I	Each	43.20			
VR TRUNK	SM2382I	Each	43.20			
DIN TRUNK	D1382I	Each	61.72			
MOULDED WITH PRESS STUDS	2382SI	Each	61.72			
MOULDED WITH PINCH CLAMPS	2382PI	Each	61.72			



Section 03 - ECG Monitoring

3-Lead & 5-Lead ECG Cables

Innocare
IM200:36281



Kontron
Micromon, Minimon,
Vitalmon, Supermon,
Kolormon



Kontron
103, 105, 107, 108, 110,
118, 120, 123, 125, 128,
VSM510/610, Old Gen

Lohmeier
M010, M011, M211,
DEF501



MDE / Invivo



MEK
MP500/600/1000



MEK



Mennen
1100, 2000, 9000



Mennen
Envoy



Mindray
PM7000/8000/9000



Mindray
PM5000/6000



Nellcor
N200/250/1000/4000/
791018



Nihon Kohden
Cardiolife, Lifescope
Series
6/8/9/11/6102/6120/620
5



Nihon Kohden



Cable Type	3-Lead			5-Lead		
	Cat No	Pack	Price	Cat No	Pack	Price
MOULDED WITH PRESS STUDS	2550SI	Each	30.86			
MOULDED WITH PINCH CLAMPS	2550PI	Each	30.86			
Cable Type	Cat No	Pack	Price	Cat No	Pack	Price
VR TRUNK	SM2398IH	Each	43.20	SM2598IH	Each	43.20
DIN TRUNK	D1398IH	Each	37.03			
MOULDED WITH PRESS STUDS	2398SIH	Each	37.03			
MOULDED WITH PINCH CLAMPS	2398PIH	Each	37.03			
Cable Type	Cat No	Pack	Price	Cat No	Pack	Price
VR TRUNK	SM2393IH	Each	43.20	SM2593IH	Each	43.20
DIN TRUNK	D1393IH	Each	37.03	D1593IH	Each	43.20
MOULDED WITH PRESS STUDS	2393SI	Each	37.03			
MOULDED WITH PINCH CLAMPS	2393PIH	Each	37.03	2593PIH	Each	43.20
Cable Type	Cat No	Pack	Price	Cat No	Pack	Price
DIN TRUNK	D1358I	Each	37.03			
MOULDED WITH PRESS STUDS	2358SI	Each	37.03			
MOULDED WITH PINCH CLAMPS	2358PI	Each	37.03			
Cable Type	Cat No	Pack	Price	Cat No	Pack	Price
VR TRUNK	SM2340I	Each	30.86	SM2540I	Each	43.20
DIN TRUNK	D1340I	Each	27.16	D1540I	Each	30.86
MOULDED WITH PRESS STUDS	2340SI	Each	27.16	2540SI	Each	30.86
MOULDED WITH PINCH CLAMPS	2340PI	Each	27.16	2540PI	Each	30.86
Cable Type	Cat No	Pack	Price	Cat No	Pack	Price
DIN TRUNK	D1310I	Each	30.86	D1510I	Each	37.03
MOULDED WITH PRESS STUDS	2310SI	Each	30.86	2510SI	Each	37.03
MOULDED WITH PINCH CLAMPS	2310PI	Each	30.86	2510PI	Each	37.03
Cable Type	Cat No	Pack	Price	Cat No	Pack	Price
DIN TRUNK	D1311I	Each	27.16	D1511I	Each	30.86
MOULDED WITH PRESS STUDS	2311SI	Each	27.16	2511SI	Each	30.86
MOULDED WITH PINCH CLAMPS	2311PI	Each	27.16	2511PI	Each	30.86
Cable Type	Cat No	Pack	Price	Cat No	Pack	Price
DIN TRUNK	D1374I	Each	37.03	D1574I	Each	43.20
MOULDED WITH PRESS STUDS	2374SI	Each	37.03	2574SI	Each	43.20
MOULDED WITH PINCH CLAMPS	2374PI	Each	37.03	2574PI	Each	43.20
Cable Type	Cat No	Pack	Price	Cat No	Pack	Price
OEM TRUNK	AA2375I	Each	43.20	AA2575I	Each	43.20
VR TRUNK	SM2375I	Each	43.20	SM2575I	Each	43.20
DIN TRUNK	D1375I	Each	37.03	D1575I	Each	43.20
MOULDED WITH PRESS STUDS	2375SI	Each	37.03	2575SI	Each	43.20
MOULDED WITH PINCH CLAMPS	2375PI	Each	37.03	2575PI	Each	43.20
Cable Type	Cat No	Pack	Price	Cat No	Pack	Price
VR TRUNK	SM2340I	Each	30.86	SM2540I	Each	43.20
DIN TRUNK	D1340I	Each	27.16	D1540I	Each	30.86
MOULDED WITH PRESS STUDS	2340SI	Each	27.16	2540SI	Each	30.86
MOULDED WITH PINCH CLAMPS	2340PI	Each	27.16	2540PI	Each	30.86
Cable Type	Cat No	Pack	Price	Cat No	Pack	Price
OEM TRUNK	MR2512I	Each	43.20	MR2512I	Each	43.20
VR TRUNK	SM2512I	Each	43.20	SM2512I	Each	43.20
DIN TRUNK	D1312I	Each	37.03	D1512I	Each	43.20
MOULDED WITH PRESS STUDS	2312SI	Each	37.03	2512SI	Each	43.20
MOULDED WITH PINCH CLAMPS	2312PI	Each	37.03	2512PI	Each	43.20
Cable Type	Cat No	Pack	Price	Cat No	Pack	Price
VR TRUNK	SM2340I	Each	30.86	SM2540I	Each	43.20
DIN TRUNK	D1340I	Each	27.16	D1540I	Each	30.86
MOULDED WITH PRESS STUDS	2340SI	Each	27.16	2540SI	Each	30.86
MOULDED WITH PINCH CLAMPS	2340PI	Each	27.16	2540PI	Each	30.86
Cable Type	Cat No	Pack	Price	Cat No	Pack	Price
OEM TRUNK	NK2508I	Each	43.20	NK2508I	Each	43.20
DIN TRUNK	D1308I	Each	37.03	D1508I	Each	43.20
MOULDED WITH PRESS STUDS	2308SI	Each	37.03	2508SI	Each	43.20
MOULDED WITH PINCH CLAMPS	2308PI	Each	37.03	2508PI	Each	43.20
Cable Type	Cat No	Pack	Price	Cat No	Pack	Price
OEM TRUNK	NK2507I	Each	43.20	NK2507I	Each	43.20
DIN TRUNK	D1307I	Each	37.03	D1507I	Each	43.20
MOULDED WITH PRESS STUDS	2307SI	Each	37.03	2507SI	Each	43.20
MOULDED WITH PINCH CLAMPS	2307PI	Each	37.03	2507PI	Each	43.20

Section 03 - ECG Monitoring

3-Lead & 5-Lead ECG Cables

Nihon Kohden
TEC 7621C/7631C/7721C
7731C/7700



Nihon Kohden
Lifescopy OPV-1500



Nihon Kohden
BSM2300 Lifescopy I,
BSM4100 Lifescopy P,
BSM5100 Lifescopy A,
BSM9510 Lifescopy M,
BSM9800 Lifescopy S



Nihon Kohden



Philips HP
Merlin System, Veridia,
Omnicare, Heartstream,
78352C, 78354C,
78834C, ML65A/66A



Philips HP
43100, 43200A,
77020A/AC/AR, 78200,
78210, 78300 Series,
78500 Series, 78600
Series



Physio Control
Lifepack
5/6/7/8/9/9P/10, VSM2,
1440, Vingmed 5



Physio Control
Lifepack 12/15/20E



Siemens
Sirecust, Polymed
Module



Siemens
SC5000 - SC9000



Spacelabs
90701, 90303, 90305,
90308, 90309, 90385



Spacelabs
Ultraview



Welch Allyn
Protocol



Cable Type	3-Lead			5-Lead		
	Cat No	Pack	Price	Cat No	Pack	Price
MOULDED WITH PRESS STUDS	2313SI	Each	43.20			
MOULDED WITH PINCH CLAMPS	2313PI	Each	43.20			
MOULDED WITH PRESS STUDS	2316SI	Each	43.20			
MOULDED WITH PINCH CLAMPS	2316PI	Each	43.20			
OEM TRUNK	NK2509I	Each	55.55	NK2509I	Each	55.55
DIN TRUNK	D1309I	Each	40.74			
MOULDED WITH PRESS STUDS	2309SI	Each	43.20	2609SI	Each	55.55
MOULDED WITH PINCH CLAMPS	2309PI	Each	43.20	2609PI	Each	55.55
OEM TRUNK	NK2540I	Each	43.20	NK2540I	Each	43.20
VR TRUNK	SM2340I	Each	30.86	SM2540I	Each	43.20
DIN TRUNK	D1340I	Each	27.16	D1540I	Each	30.86
MOULDED WITH PRESS STUDS	2340SI	Each	27.16	2540SI	Each	30.86
MOULDED WITH PINCH CLAMPS	2340PI	Each	27.16	2540PI	Each	30.86
OEM TRUNK(1)	AA2385I	Each	43.20	AA2585I	Each	43.20
OEM TRUNK(2)	HP2385I	Each	48.14	HP2585I	Each	55.55
VR TRUNK	SM2385I	Each	43.20	SM2585I	Each	43.20
DIN TRUNK	D1385I	Each	37.03	D1585I	Each	43.20
MOULDED WITH PRESS STUDS	2385SI	Each	37.03	2585SI	Each	43.20
MOULDED WITH PINCH CLAMPS	2385PI	Each	37.03	2585PI	Each	43.20
OEM TRUNK(1)	AA23029I	Each	43.20	AA25029I	Each	43.20
VR TRUNK	SM23029I	Each	43.20	SM25029I	Each	43.20
DIN TRUNK	D13029I	Each	37.03	D15029I	Each	43.20
MOULDED WITH PRESS STUDS	23029SI	Each	37.03	25029SI	Each	43.20
MOULDED WITH PINCH CLAMPS	23029PI	Each	37.03	25029PI	Each	43.20
OEM TRUNK	DX2340RI	Each	43.20	SM2540RI	Each	43.20
VR TRUNK	SM2340RI	Each	30.86	D1540RI	Each	30.86
DIN TRUNK	D1340RI	Each	27.16	2540RSI	Each	30.86
MOULDED WITH PRESS STUDS	2340RSI	Each	27.16	2540RPI	Each	30.86
MOULDED WITH PINCH CLAMPS	2340RPI	Each	27.16			
MOULDED WITH PRESS STUDS	2327SI	Each	37.03	2527SI	Each	43.20
MOULDED WITH PINCH CLAMPS	2327PI	Each	37.03	2527PI	Each	43.20
OEM TRUNK	SM2376I	Each	43.20	SM2576I	Each	43.20
VR TRUNK	SM2376I	Each	43.20	SM2576I	Each	43.20
DIN TRUNK	D1376I	Each	37.03	D1576I	Each	43.20
MOULDED WITH PRESS STUDS	2376SI	Each	37.03	2576SI	Each	43.20
MOULDED WITH PINCH CLAMPS	2376PI	Each	37.03	2576PI	Each	43.20
OEM TRUNK	SM2323I	Each	55.55			
DIN TRUNK	D1323I	Each	43.20			
MOULDED WITH PRESS STUDS	2323SI	Each	43.20			
MOULDED WITH PINCH CLAMPS	2323PI	Each	43.20			
VR TRUNK	SM2340I	Each	30.86	SM2540I	Each	43.20
DIN TRUNK	D1340I	Each	27.16	D1540I	Each	30.86
MOULDED WITH PRESS STUDS	2340SI	Each	27.16	2540SI	Each	30.86
MOULDED WITH PINCH CLAMPS	2340PI	Each	27.16	2540PI	Each	30.86
OEM TRUNK	SL2396I	Each	43.20	SL2596I	Each	43.20
VR TRUNK	SM2396I	Each	43.20	SM2596I	Each	43.20
DIN TRUNK	D1396I	Each	37.03	D1596I	Each	43.20
MOULDED WITH PRESS STUDS	2396SI	Each	37.03	2596SI	Each	43.20
MOULDED WITH PINCH CLAMPS	2396PI	Each	37.03	2596PI	Each	43.20
VR TRUNK	SM2340I	Each	30.86	SM2540I	Each	43.20
DIN TRUNK	D1340I	Each	27.16	D1540I	Each	30.86
MOULDED WITH PRESS STUDS	2340SI	Each	27.16	2540SI	Each	30.86
MOULDED WITH PINCH CLAMPS	2340PI	Each	27.16	2540PI	Each	30.86



Section 03 - ECG Monitoring

3-Lead & 5-Lead ECG Cables

Welch Allyn
Micropaq, Propaq LT



Zoll
E, M, MCCT & R Series



Cable Type	3-Lead			5-Lead		
	Cat No	Pack	Price	Cat No	Pack	Price
VR TRUNK	SM2353I	Each	48.14	SM2553I	Each	48.14
DIN TRUNK	D1353I	Each	48.14	D1553I	Each	48.14
MOULDED WITH PRESS STUDS	2353SI	Each	27.16	2553SI	Each	30.86
MOULDED WITH PINCH CLAMPS	2353PI	Each	27.16	2553PI	Each	30.86

Cable Type	3-Lead			5-Lead		
	Cat No	Pack	Price	Cat No	Pack	Price
MOULDED WITH PRESS STUDS	21069SI	Each	74.06			
MOULDED WITH PINCH CLAMPS	21069PI	Each	74.06			

Replacement Leadwires (90cm) for OEM Trunk Cables

Leadwires to fit:	Set of 3 Press Studs		Set of 5 Press Studs		Set of 3 Pinch Clamps		Set of 5 Pinch Clamps	
	Cat No	Price	Cat No	Price	Cat No	Price	Cat No	Price
AAMI	LL390SI	22.22	LL590SI	30.86	LL390PI	22.22	LL590PI	30.86
COLIN	CL390SI	22.22	CL590SI	30.86	CL390PI	22.22	CL590PI	30.86
DATASCOPE / MINDRAY	DT390SI	30.86	DT590SI	30.86	DT390PI	30.86	DT590PI	30.86
DRAEGER	DG390SI	40.74	DG590SI	40.74	DG390PI	40.74	DG590PI	40.74
FUKUDA DENSHI	SM390SI	22.22	SM590SI	30.86	SM390PI	22.22	SM590PI	30.86
GE CRITIKON	DX390SI	22.22	DX590SI	30.86	DX390PI	22.22	DX590PI	30.86
GE DATEX OHMEDA	DX390SI	22.22	DX590SI	30.86	DX390PI	22.22	DX590PI	30.86
GE HELLIGE	DX390SI	22.22	DX590SI	30.86	DX390PI	22.22	DX590PI	30.86
GE MARQUETTE	MQ390SI	30.86	MQ590SI	30.86	MQ390PI	30.86	MQ590PI	30.86
LOHMEIER	SM3L90SI	22.22	SM5L90SI	30.86	SM3L90PI	22.22	SM5L90PI	30.86
MENNEN	MN390SI	22.22	MN590SI	30.86	MN390PI	22.22	MN590PI	30.86
MINDRAY	MR390SI	22.22	MR590SI	30.86	MR390PI	22.22	MR590PI	30.86
NIHON KOHDEN - NK2508I	NKA390SI	22.22	NKA590SI	30.86	NKA390PI	22.22	NKA590PI	30.86
NIHON KOHDEN - NK2507I	NKA390SI	22.22	NKA590SI	30.86	NKA390PI	22.22	NKA590PI	30.86
NIHON KOHDEN - NK2509I	NKB390SI	22.22	NKB690SI	33.33	NKB390PI	22.22	NKB690PI	33.33
NIHON KOHDEN - NK2540I	NKA390SI	22.22	NKA590SI	30.86	NKA390PI	22.22	NKA590PI	30.86
PHILIPS HP (1)	AA390SI	22.22	AA590SI	30.86	AA390PI	22.22	AA590PI	30.86
PHILIPS HP (2)	HP390SI	30.86	HPA590SI	30.86	HP390PI	30.86	HPA590PI	30.86
PHYSIO CONTROL	DX390SI	22.22	DX590SI	30.86	DX390PI	22.22	DX590PI	30.86
SIEMENS	SM390SI	22.22	SM590SI	30.86	SM390PI	22.22	SM590PI	30.86
SPACELABS	SL390SI	22.22	SL590SI	30.86	SL390PI	22.22	SL590PI	30.86



Replacement Leadwires (90cm) for VR Trunk Cables (moulded)

Description/Colour	Press Stud			Pinch Clamp		
	Cat No	Pack	Price	Cat No	Pack	Price
RED, YELLOW & BLACK	SM390SIH	Set	22.22	SM390PIH	Set	22.22
RED, YELLOW & GREEN	SM390SI	Set	22.22	SM390PI	Set	22.22
RED, YELLOW, BLACK, GREEN & WHITE	SMA590SI	Set	30.86	SMA590PI	Set	30.86
RED, YELLOW & BLACK - WITH FILTER	SM390RSIH	Set	22.22	SM390RPIH	Set	22.22
RED, YELLOW & GREEN - WITH FILTER	SM390RSI	Set	22.22	SM390RPI	Set	22.22
RED, YELLOW, BLACK, GREEN & WHITE - WITH FILTER	SMA590RSI	Set	30.86	SMA590RPI	Set	30.86



Replacement Leadwires (90cm) for VR Trunk Cables (5-lead moulded with 2 missing)

Description/Colour	Press Stud			Pinch Clamp		
	Cat No	Pack	Price	Cat No	Pack	Price
RED, YELLOW & BLACK	SMB390SIH	Set	27.16	SMB390PIH	Set	27.16
RED, YELLOW & GREEN	SMB390SI	Set	27.16	SMB390PI	Set	27.16



Replacement Leadwires (90cm) for VR Trunk Cables (with replaceable individual leads)

Description/Colour	Press Stud			Pinch Clamp		
	Cat No	Pack	Price	Cat No	Pack	Price
RED, YELLOW & BLACK	SMD390SIH	Set	24.69	SMD390PIH	Set	24.69
RED, YELLOW & GREEN	SMD390SI	Set	24.69	SMD390PI	Set	24.69
RED, YELLOW, BLACK, GREEN & WHITE	SMD590SI	Set	37.03	SMD590PI	Set	37.03
3 LEAD CABLE HOUSING	Y05T029T030	Each	2.47			
5 LEAD CABLE HOUSING	Y05T018T019	Each	2.47			



Section 03 - ECG Monitoring

Replacement Leadwires (90cm) for DIN Trunk Cables

Colour	Press Stud			Pinch Clamp		
	Cat No	Pack	Price	Cat No	Pack	Price
BLACK	XD90SKI	Each	3.09	XD90PKI	Each	3.09
GREEN	XD90SEI	Each	3.09	XD90PEI	Each	3.09
RED	XD90SRI	Each	3.09	XD90PRI	Each	3.09
WHITE	XD90SWI	Each	3.09	XD90PWI	Each	3.09
YELLOW	XD90SYI	Each	3.09	XD90PYI	Each	3.09
RED, YELLOW & BLACK	D390SIH	Set	7.41	D390PIH	Set	11.11
RED, YELLOW & GREEN	D390SI	Set	7.41	D390PI	Set	11.11
RED, YELLOW, BLACK, GREEN & WHITE	D590SI	Set	12.35	D590PI	Set	37.03
RED, YELLOW & BLACK - NEONATAL				D390NPIH	Set	12.35
RED, YELLOW & GREEN - NEONATAL				D390NPI	Set	12.35
RED, YELLOW, BLACK, GREEN & WHITE - NEONATAL				D590NPI	Set	17.28



Telemetry ECG Cables

90cm leadwire sets for all major brands of ECG transmitter and Holter systems.

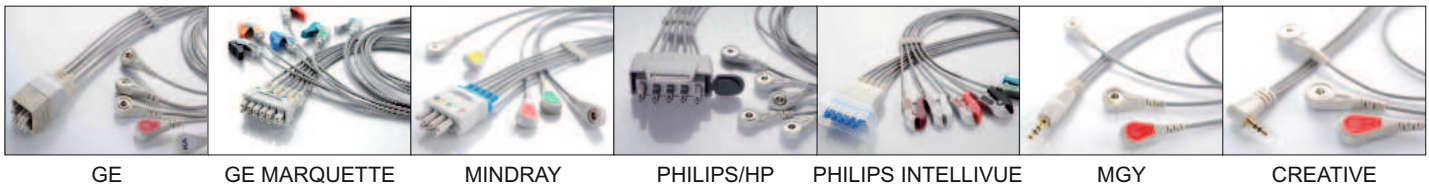

Leadwires to fit:	Leads	Type	Cat No	Pack	Price
GE	3	PRESS STUD	AP390SI	Each	43.20
GE	5	PRESS STUD	AP590SI	Each	48.14
GE	6	PRESS STUD	AP690SI	Each	55.55
GE MARQUETTE	6	PRESS STUD	MQB690SI	Each	43.20
GE MARQUETTE	6	PRESS STUD	MQB6120SI	Each	43.20
MINDRAY	5	PRESS STUD	TM590SI	Each	48.14
PHILIPS/HP	3	PRESS STUD	AT390SI	Each	48.14
PHILIPS/HP	3	PINCH CLAMP	AT390PI	Each	48.14
PHILIPS/HP	5	PRESS STUD	AT590SI	Each	55.55

Leadwires to fit:	Leads	Type	Cat No	Pack	Price
PHILIPS/HP	5	PINCH CLAMP	AT590PI	Each	55.55
PHILIPS INTELLIVUE	3	PRESS STUD	HT390SI	Each	30.86
PHILIPS INTELLIVUE	3	PINCH CLAMP	HT390PI	Each	30.86
PHILIPS INTELLIVUE	5	PRESS STUD	HT590SI	Each	37.03
PHILIPS INTELLIVUE	5	PINCH CLAMP	HT590PI	Each	37.03
MGY	3	PRESS STUD	H35390SI	Each	24.69
MGY	3	PINCH CLAMP	H35390PI	Each	24.69
CREATIVE	3	PRESS STUD	H25390SI	Each	24.69
CREATIVE	3	PINCH CLAMP	H25390PI	Each	24.69



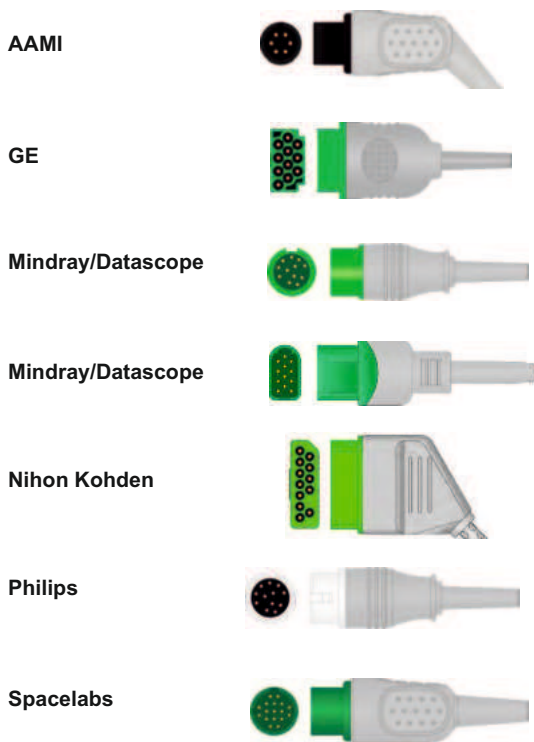













Disposable One-Piece ECG Cables



	Press Stud				Pinch Clamp		
	No of Leads	Cat No	Pack	Price	Cat No	Pack	Price
AAMI	3	2340DSI	8	177.76	2340DPI	8	177.76
	5	2540DSI	8	148.40	2540DPI	8	148.40
GE	3	2386DSI	8	118.56	2386DPI	8	118.56
	5	2586DSI	8	138.24	2586DPI	8	138.24
Mindray/Datascope	3	2312DSI	8	118.56	2312DPI	8	118.56
	5	2512DSI	8	138.24	2512DPI	8	138.24
Mindray/Datascope	3	2326DSI	8	138.24	2326DPI	8	138.24
	5	2526DSI	8	177.76	2526DPI	8	177.76
Nihon Kohden	3	2309DSI	8	138.24	2309DPI	8	138.24
	6	2609DSI	8	177.76	2609DPI	8	177.76
Philips	3	2385DSI	8	138.24	2385DPI	8	138.24
	5	2585DSI	8	177.76	2585DPI	8	177.76
Spacelabs	3	2396DSI	8	138.24	2396DPI	8	138.24
	5	2596DSI	8	177.76	2596DPI	8	177.76

Section 03 - ECG Monitoring

Disposable Leadwires

		Press Stud			Pinch Clamp			
		<i>No of Leads</i>	<i>Cat No</i>	<i>Pack</i>	<i>Price</i>	<i>Cat No</i>	<i>Pack</i>	<i>Price</i>
Datascope		3	DT390DSI	10	98.80	DT390DPI	10	98.80
		5	DT590DSI	10	98.80	DT590DPI	10	98.80
Draeger/Siemens		3	DG390DSI	10	110.10	DG390DPI	10	111.10
		5	DG590DSI	10	111.10	DG590DPI	10	111.10
		6	DG690DSI	10	111.10	DG690DPI	10	148.20
Draeger/Siemens		3	SM390DSI	10	98.80	SM390DPI	10	98.80
		5	SM590DSI	10	98.80	SM590DPI	10	98.80
GE		3	MQ390DSI	10	98.80	MQ390DPI	10	98.80
		5	MQ590DSI	10	74.10	MQ590DPI	10	98.80
GE		5	MV590DSI	10	74.10	MV590DPI	10	98.80
GE		6	MQB690DSI	10	111.10	MQB690DPI	10	148.20
Mindray		3	MR390DSI	10	98.80	MR390DPI	10	98.80
		5	MR590DSI	10	98.80	MR590DPI	10	98.80
Nihon Kohden		3	NKB390DSI	10	98.80	NKB390DPI	10	98.80
		6	NKB690DSI	10	111.10	NKB690DPI	10	148.20
Philips		3	HP390DSI	10	111.10	HP390DPI	10	111.10
Philips		5	HPA590DSI	10	74.10	HPA590DPI	10	111.10
Philips		5	HPB590DSI	10	74.10	HPB590DPI	10	111.10
Philips		3	HT390DSI	10	148.20	HT390DPI	10	148.20
		5	HT590DSI	10	111.10	HT590DPI	10	148.20
Philips		3	AAB390DSI	10	61.80	AAB390DPI	10	111.10
Philips		5	AAB590DSI	10	74.10	AAB590DPI	10	111.10
Philips		3	AT390DSI	10	111.10	AT390DPI	10	148.20
Philips		5	AT590DSI	10	111.10	AT590DPI	10	148.20
Spacelabs		3	SLB390DSI	10	98.80	SLB390DPI	10	98.80
		5	SL590DSI	10	98.80	SL590DPI	10	98.80

Section 03 - ECG Monitoring

10-Lead ECG Cables

Bosch

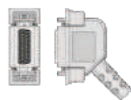

Cable Type	Without Resistors			With Resistors		
	Cat No	Pack	Price	Cat No	Pack	Price
OEM TRUNK	E10HLI	Each	74.06	E10RHLI	Each	74.06
MOULDED WITH 4mm PLUGS	E10HLBI	Each	74.06	E10RHLBI	Each	74.06
MOULDED WITH 3mm NEEDLES	E10HLNI	Each	74.06	E10RHLNI	Each	74.06
MOULDED WITH PINCH CLAMPS	E10HLPI	Each	74.06	E10RHLPI	Each	74.06

Burdick

EK10, E350, E350i, E550, E560, Eclipse, Elite

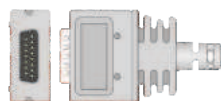

Cable Type	Without Resistors			With Resistors		
	Cat No	Pack	Price	Cat No	Pack	Price
OEM TRUNK	E10BK1I	Each	74.06	E10RBK1I	Each	74.06
MOULDED WITH 4mm PLUGS	E10BK1BI	Each	74.06	E10RBK1BI	Each	74.06
MOULDED WITH 3mm NEEDLES	E10BK1NI	Each	74.06	E10RBK1NI	Each	74.06
MOULDED WITH PINCH CLAMPS	E10BK1PI	Each	74.06	E10RBK1PI	Each	74.06

Burdick

Quinton Eclipse, 4, 8, 400, 800, 850, 850i, LE, Atria Plus



Cable Type	Without Resistors			With Resistors		
	Cat No	Pack	Price	Cat No	Pack	Price
OEM TRUNK	E10BK2I	Each	74.06	E10RBK2I	Each	74.06
MOULDED WITH 4mm PLUGS	E10BK2BI	Each	74.06	E10RBK2BI	Each	74.06
MOULDED WITH 3mm NEEDLES	E10BK2NI	Each	74.06	E10RBK2NI	Each	74.06
MOULDED WITH PINCH CLAMPS	E10BK2PI	Each	74.06	E10RBK2PI	Each	74.06

Fukuda Denshi

FX101/102F/328U, FCP2201



Cable Type	Without Resistors			With Resistors		
	Cat No	Pack	Price	Cat No	Pack	Price
OEM TRUNK	E10FD1I	Each	74.06	E10RFD1I	Each	74.06
MOULDED WITH 4mm PLUGS	E10FD1BI	Each	74.06	E10RFD1BI	Each	74.06
MOULDED WITH 3mm NEEDLES	E10FD1NI	Each	74.06	E10RFD1NI	Each	74.06
MOULDED WITH PINCH CLAMPS	E10FD1PI	Each	74.06	E10RFD1PI	Each	74.06

Fukuda Denshi



Cable Type	Without Resistors			With Resistors		
	Cat No	Pack	Price	Cat No	Pack	Price
OEM TRUNK	MQ21099I	Each	74.06			
MOULDED WITH PRESS STUDS	FD21099SI	Each	74.06			
MOULDED WITH PINCH CLAMPS	FD21099PI	Each	74.06			

Fukuda ME

KP500/500D



Cable Type	Without Resistors			With Resistors		
	Cat No	Pack	Price	Cat No	Pack	Price
OEM TRUNK	E10FD2I	Each	74.06	E10RFD2I	Each	74.06
MOULDED WITH 4mm PLUGS	E10FD2BI	Each	74.06	E10RFD2BI	Each	74.06
MOULDED WITH 3mm NEEDLES	E10FD2NI	Each	74.06	E10RFD2NI	Each	74.06
MOULDED WITH PINCH CLAMPS	E10FD2PI	Each	74.06	E10RFD2PI	Each	74.06

GE Marquette

MAC500/1100/1200



Cable Type	Without Resistors			With Resistors		
	Cat No	Pack	Price	Cat No	Pack	Price
OEM TRUNK	E10MQI	Each	74.06	E10RMQI	Each	74.06
MOULDED WITH 4mm PLUGS	E10MQ5BI	Each	74.06	E10RMQ5BI	Each	74.06
MOULDED WITH 3mm NEEDLES	E10MQ5NI	Each	74.06	E10RMQ5NI	Each	74.06
MOULDED WITH PINCH CLAMPS	E10MQ5PI	Each	74.06	E10RMQ5PI	Each	74.06

GE Marquette

Eagle, Solar, Dash, Mac Lab, Datex-Ohmeda



Cable Type	Without Resistors			With Resistors		
	Cat No	Pack	Price	Cat No	Pack	Price
OEM TRUNK	MQ21086I	Each	74.06			
MOULDED WITH PRESS STUDS	21086SI	Each	74.06			
MOULDED WITH PINCH CLAMPS	21086PI	Each	74.06			

Hellige

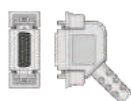

Cable Type	Without Resistors			With Resistors		
	Cat No	Pack	Price	Cat No	Pack	Price
OEM TRUNK	E10HLI	Each	74.06	E10RHLI	Each	74.06
MOULDED WITH 4mm PLUGS	E10HLBI	Each	74.06	E10RHLBI	Each	74.06
MOULDED WITH 3mm NEEDLES	E10HLNI	Each	74.06	E10RHLNI	Each	74.06
MOULDED WITH PINCH CLAMPS	E10HLPI	Each	74.06	E10RHLPI	Each	74.06

Kenz

103, 106, Cardioline



Cable Type	Without Resistors			With Resistors		
	Cat No	Pack	Price	Cat No	Pack	Price
OEM TRUNK	E10KZ1I	Each	74.06	E10RKZ1I	Each	74.06
MOULDED WITH 4mm PLUGS	E10KZ1BI	Each	74.06	E10RKZ1BI	Each	74.06
MOULDED WITH 3mm NEEDLES	E10KZ1NI	Each	74.06	E10RKZ1NI	Each	74.06
MOULDED WITH PINCH CLAMPS	E10KZ1PI	Each	74.06	E10RKZ1PI	Each	74.06

Kenz

108, 110, 302, 601, 1210, 1211



Cable Type	Without Resistors			With Resistors		
	Cat No	Pack	Price	Cat No	Pack	Price
OEM TRUNK	E10KZ2I	Each	74.06	E10RKZ2I	Each	74.06
MOULDED WITH 4mm PLUGS	E10KZ2BI	Each	74.06	E10RKZ2BI	Each	74.06
MOULDED WITH 3mm NEEDLES	E10KZ2NI	Each	74.06	E10RKZ2NI	Each	74.06
MOULDED WITH PINCH CLAMPS	E10KZ2PI	Each	74.06	E10RKZ2PI	Each	74.06

Mortara

ELI50/100/200



Cable Type	Without Resistors			With Resistors		
	Cat No	Pack	Price	Cat No	Pack	Price
OEM TRUNK	E10MTI	Each	74.06	E10RMTI	Each	74.06
MOULDED WITH 4mm PLUGS	E10MTBI	Each	74.06	E10RMTBI	Each	74.06
MOULDED WITH 3mm NEEDLES	E10MTNI	Each	74.06	E10RMTNI	Each	74.06
MOULDED WITH PINCH CLAMPS	E10MTPi	Each	74.06	E10RMTPI	Each	74.06

Nihon Kohden

CardioFax
6151/6353/6851/8110



Cable Type	Without Resistors			With Resistors		
	Cat No	Pack	Price	Cat No	Pack	Price
OEM TRUNK	E10NK1I	Each	74.06	E10RNK1I	Each	74.06
MOULDED WITH 4mm PLUGS	E10NK1BI	Each	74.06	E10RNK1BI	Each	74.06
MOULDED WITH 3mm NEEDLES	E10NK1NI	Each	74.06	E10RNK1NI	Each	74.06
MOULDED WITH PINCH CLAMPS	E10NK1PI	Each	74.06	E10RNK1PI	Each	74.06

Nihon Kohden

CardioFax Q,
Cardioline (New)



Cable Type	Without Resistors			With Resistors		
	Cat No	Pack	Price	Cat No	Pack	Price
OEM TRUNK	E10NK2I	Each	74.06	E10RNK2I	Each	74.06
MOULDED WITH 4mm PLUGS	E10NK2BI	Each	74.06	E10RNK2BI	Each	74.06
MOULDED WITH 3mm NEEDLES	E10NK2NI	Each	74.06	E10RNK2NI	Each	74.06
MOULDED WITH PINCH CLAMPS	E10NK2PI	Each	74.06	E10RNK2PI	Each	74.06

Philips HP

Pagewriter 100/200/200i,
M1770A, M1771A, M1772A



Cable Type	Without Resistors			With Resistors		
	Cat No	Pack	Price	Cat No	Pack	Price
OEM TRUNK	E10HPI	Each	74.06	E10RHPI	Each	74.06
MOULDED WITH 4mm PLUGS	E10HPBI	Each	74.06	E10RHPIBI	Each	74.06
MOULDED WITH 3mm NEEDLES	E10HPNI	Each	74.06	E10RHPINI	Each	74.06
MOULDED WITH PINCH CLAMPS	E10HPPI	Each	74.06	E10RHPIPI	Each	74.06

Philips HP



Cable Type	Without Resistors			With Resistors		
	Cat No	Pack	Price	Cat No	Pack	Price
OEM TRUNK	HP21085I	Each	74.06			
MOULDED WITH PRESS STUDS	HP21085SI	Each	74.06			
MOULDED WITH PINCH CLAMPS	HP21085PI	Each	74.06			

Schiller

AT1, AT2, AT2plus, AT4
Long Screw



Cable Type	Without Resistors			With Resistors		
	Cat No	Pack	Price	Cat No	Pack	Price
OEM TRUNK	E10SH1I	Each	74.06	E10RSH1I	Each	74.06
MOULDED WITH 4mm PLUGS	E10SH1BI	Each	74.06	E10RSH1BI	Each	74.06
MOULDED WITH 3mm NEEDLES	E10SH1NI	Each	74.06	E10RSH1NI	Each	74.06
MOULDED WITH PINCH CLAMPS	E10SH1PI	Each	74.06	E10RSH1PI	Each	74.06



Section 03 - ECG Monitoring

10-Lead ECG Cables

Schiller
AT3, AT5, AT6, AT10,
AT60, CS6
Short Screw



Siemens

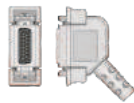

Spacelabs



Unimed
UB101G, UB300G,
UB1200

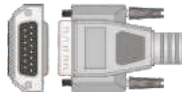

Cable Type	Without Resistors			With Resistors		
	Cat No	Pack	Price	Cat No	Pack	Price
OEM TRUNK	E10SH2I	Each	74.06	E10RSH2I	Each	74.06
MOULDED WITH 4mm PLUGS	E10SH2BI	Each	74.06	E10RSH2BI	Each	74.06
MOULDED WITH 3mm NEEDLES	E10SH2NI	Each	74.06	E10RSH2NI	Each	74.06
MOULDED WITH PINCH CLAMPS	E10SH2PI	Each	74.06	E10RSH2PI	Each	74.06
Cable Type	Cat No	Pack	Price	Cat No	Pack	Price
OEM TRUNK	E10HLI	Each	74.06	E10RHLI	Each	74.06
MOULDED WITH 4mm PLUGS	E10HLBI	Each	74.06	E10RHLBI	Each	74.06
MOULDED WITH 3mm NEEDLES	E10HLNI	Each	74.06	E10RHLNI	Each	74.06
MOULDED WITH PINCH CLAMPS	E10HLPI	Each	74.06	E10RHLPI	Each	74.06
Cable Type	Cat No	Pack	Price			
OEM TRUNK	SL21086I	Each	74.06			
MOULDED WITH PRESS STUDS	SL21086SI	Each	74.06			
MOULDED WITH PINCH CLAMPS	SL21086PI	Each	74.06			
Cable Type	Cat No	Pack	Price	Cat No	Pack	Price
OEM TRUNK	E10NK2I	Each	74.06	E10RNK2I	Each	74.06
MOULDED WITH 4mm PLUGS	E10NK2BI	Each	74.06	E10RNK2BI	Each	74.06
MOULDED WITH 3mm NEEDLES	E10NK2NI	Each	74.06	E10RNK2NI	Each	74.06
MOULDED WITH PINCH CLAMPS	E10NK2PI	Each	74.06	E10RNK2PI	Each	74.06

Replacement Leadwires (90cm) for OEM Trunk Cables

GE Marquette (Set x5 Brown). Fits Henleys Trunks
E10HLI, MQ21099I, E10MQI, MQ21086I & GE Marquette OEM Trunks.

Cable Type	Cat No	Pack	Price
PRESS STUDS	MV590SI	Each	30.86
PINCH CLAMPS	MV590PI	Each	30.86
4mm PLUGS	MV590BI	Each	30.86
3mm NEEDLES	MV590NI	Each	30.86

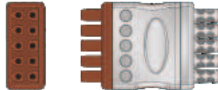

GE Marquette (Set x5 Grey). Fits Henleys Trunks
E10HLI, MQ21099I, E10MQI, MQ21086I & GE Marquette OEM Trunks.

Cable Type	Cat No	Pack	Price
PRESS STUDS	MQ590SI	Each	30.86
PINCH CLAMPS	MQ590PI	Each	30.86
4mm PLUGS	MQ590BI	Each	30.86
3mm NEEDLES	MQ590NI	Each	30.86

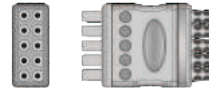

GE Marquette (Set x10 Grey/Brown). Fits Henleys Trunks
E10HLI, MQ21099I, E10MQI, MQ21086I & GE Marquette OEM Trunks.

Cable Type	Cat No	Pack	Price
PRESS STUDS	MQ10LSI	Each	61.72
PINCH CLAMPS	MQ10LPI	Each	61.72
4mm PLUGS	MQ10LBI	Each	61.72
3mm NEEDLES	MQ10LNI	Each	61.72

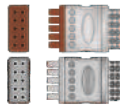

GE Marquette (Set x10). Fits GE Marquette OEM Trunks.



Cable Type	Cat No	Pack	Price
PRESS STUDS	MQD10LSI	Each	61.72
PINCH CLAMPS	MQD10LPI	Each	61.72
4mm PLUGS	MQD10LBI	Each	61.72
3mm NEEDLES	MQD10LNI	Each	61.72

Mortara (Set x10). Fits Mortara Trunks

Cable Type	Cat No	Pack	Price
PRESS STUDS	MT10LSI	Each	61.72
PINCH CLAMPS	MT10LPI	Each	61.72
4mm PLUGS	MT10LBI	Each	61.72
3mm NEEDLES	MT10LNI	Each	61.72

Norav (Set x10). Fits Norav OEM Trunks.



Cable Type	Cat No	Pack	Price
PRESS STUDS	AA10LSI	Each	61.72
PINCH CLAMPS	AA10LPI	Each	61.72
4mm PLUGS	AA10LBI	Each	61.72
3mm NEEDLES	AA10LNI	Each	61.72

Philips HP (Set x5 Blue). Fits Henleys Trunk HP21085I
& Philips HP OEM Trunks.

Cable Type	Cat No	Pack	Price
PRESS STUDS	HPA590SI	Each	30.86
PINCH CLAMPS	HPA590PI	Each	30.86
4mm PLUGS	HPA590BI	Each	30.86
3mm NEEDLES	HPA590NI	Each	30.86



Philips HP (Set x5 Red). Fits Henleys Trunk HP21085I
& Philips HP OEM Trunks.

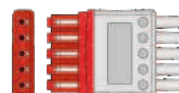

Cable Type	Cat No	Pack	Price
PRESS STUDS	HPB590SI	Each	30.86
PINCH CLAMPS	HPB590PI	Each	30.86
4mm PLUGS	HPB590BI	Each	30.86
3mm NEEDLES	HPB590NI	Each	30.86

Philips HP (Set x10).
Fits Philips OEM Trunks.

Cable Type	Cat No	Pack	Price
PRESS STUDS	PW10LSI	Each	61.72
PINCH CLAMPS	PW10LPI	Each	61.72
4mm PLUGS	PW10LBI	Each	61.72
3mm NEEDLES	PW10LNI	Each	61.72



Quinton (Set x10). Fits Quinton OEM Trunks.

Cable Type	Cat No	Pack	Price
PRESS STUDS	QT590SI	Each	#N/A
PINCH CLAMPS	QT590PI	Each	#N/A
4mm PLUGS	QT590BI	Each	#N/A
3mm NEEDLES	QT590NI	Each	#N/A

Welch Allyn (Set x10).
Fits Welch Allyn OEM Trunks.

Cable Type	Cat No	Pack	Price
PRESS STUDS	WA10LSI	Each	61.72
PINCH CLAMPS	WA10LPI	Each	61.72
4mm PLUGS	WA10LBI	Each	61.72
3mm NEEDLES	WA10LNI	Each	61.72



Section 03 - ECG Monitoring

GE Trunks & Leadwires for CAM14



Cat No		Pack	Price
ECAMGE14S	COILED CABLE FOR GE CAM14, 1.3m	Each	271.55
ECAMGE14	COILED CABLE FOR GE CAM14, 4.6m	Each	271.55
MQB10LBI	REPLACEMENT LEADWIRES WITH 4mm BANANA PLUGS	10	61.72
MQB10LNI	REPLACEMENT LEADWIRES WITH 3mm NEEDLES	10	61.72
MQB10LPI	REPLACEMENT LEADWIRES WITH PINCH CLAMPS	10	61.72
MQB10LSI	REPLACEMENT LEADWIRES WITH PRESS STUDS	10	61.72
MQB10ADI	UNIVERSAL LEADWIRES	10	61.72
MQB14ADI	UNIVERSAL LEADWIRES	14	74.06
XMQB90DF	UNIVERSAL LEADWIRE 90cm	10	55.55
XMQB120DF	UNIVERSAL LEADWIRE 120cm	10	55.55

GE Trunks & Leadwires for AM4/AM5



Cat No		Pack	Price
EAMGE4S	CABLE FOR GE CAM4, 1.3m	Each	247.00
EAMGE4	CABLE FOR GE CAM4, 4.6m	Each	247.00
MQD10LBI	REPLACEMENT LEADWIRES WITH 4mm BANANA PLUGS	10	61.72
MQD10LNI	REPLACEMENT LEADWIRES WITH 3mm NEEDLES	10	61.72
MQD10LPI	REPLACEMENT LEADWIRES WITH PINCH CLAMPS	10	61.72
MQD10LSI	REPLACEMENT LEADWIRES WITH PRESS STUDS	10	61.72
MQD12ADI	UNIVERSAL LEADWIRES	12	74.06
XMQD90DF	UNIVERSAL LEADWIRE 90cm	10	55.55
XMQD120DF	UNIVERSAL LEADWIRE 120cm	10	55.55

GE Electrode Adaptors



Cat No		Pack	Price
AD10DBI	4mm BANANA PLUG ADAPTORS	10	24.69
AD12DBI	4mm BANANA PLUG ADAPTORS	12	30.86
AD14DBI	4mm BANANA PLUG ADAPTORS	14	33.33

Siemens Draeger MultiMed Pod Cable

Cat No		Length	Pack	Price
SMSTE5	MULTIMED 5 POD, 5 LEAD ECG, SpO2, TEMP & RESP	2.5m	Each	160.00
SM15STE5	MULTIMED 5 POD, 5 LEAD ECG, SpO2, TEMP & RESP	1.5m	Each	271.55
SMSTE6	MULTIMED 6 POD, 6 LEAD ECG, SpO2, TEMP & RESP	2.5m	Each	309.00
SMMX5	NEOMED POD, ECG, SpO2, DUAL TEMP, RESP & FiO2	2.5m	Each	309.00
DGSTE6	MULTIMED PLUS, 6 LEAD ECG, SpO2, TEMP & RESP	2.5m	Each	309.00
Y05T091	BRACKET FOR UNIMED POD CABLES		Each	30.86
Y05T092	BRACKET FOR SIEMENS/DRAEGER OEM POD CABLES		Each	43.20

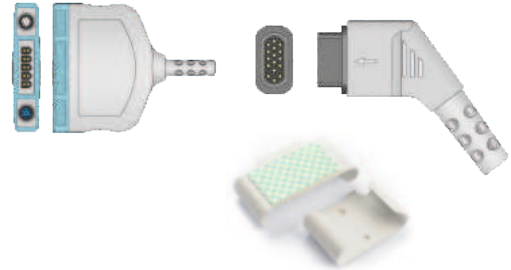

ECG Adaptors

Cat No		Pack	Price
ADBS	PRESS STUD LEADWIRE WITH 4mm SOCKET, 0.3m	10	24.69
ADBS10	PRESS STUD ADAPTOR WITH 4mm SOCKET	10	24.69
ADNS	PRESS STUD LEADWIRE WITH 3mm SOCKET, 0.3m	10	24.69
ADBP	PINCH CLAMP LEADWIRE WITH 4mm SOCKET, 0.3m	10	24.69
ADBP10	PINCH CLAMP ADAPTOR WITH 4mm SOCKET	10	24.69
ADNP	PINCH CLAMP LEADWIRE WITH 3mm SOCKET, 0.3m	10	24.69
ADBF10	FLAT CLIP WITH 4mm SOCKET RED	10	22.22
ADNF10	FLAT CLIP WITH 3mm SOCKET BLUE	10	22.22
ADBA10	ALLIGATOR CLIP WITH 4mm SOCKET GREY/RED	10	22.22
ADNA10	ALLIGATOR CLIP WITH 3mm SOCKET GREY/BLUE	10	22.22
EASICLIP	SKINTACT EASICLIP	10	18.00



ECG Limb & Chest Electrodes

Cat No		Pack	Price
UULCA	LIMB CLAMPS ADULT RED, BLACK, GREEN & YELLOW	Set	17.28
UULCP	LIMB CLAMPS PAEDIATRIC RED, BLACK, GREEN & YELLOW	Set	17.28
UULCAA	LIMB CLAMPS ADULT 4 x GREEN	Set	17.28
UULCPA	LIMB CLAMPS PAEDIATRIC 4 x GREEN	Set	17.28
UUSEA	SUCTION ELECTRODE ADULT 6 x BLUE	Set	24.69
Y05F021	REPLACEMENT BULB FOR ADULT SUCTION ELECTRODE 6 x BLUE	Set	7.41
UUSEP	SUCTION ELECTRODE PAEDIATRIC 6 x GREEN	Set	24.69
Y05F022	REPLACEMENT BULB FOR PAEDIATRIC SUCTION ELECTRODE 6 x GREEN	Set	7.41

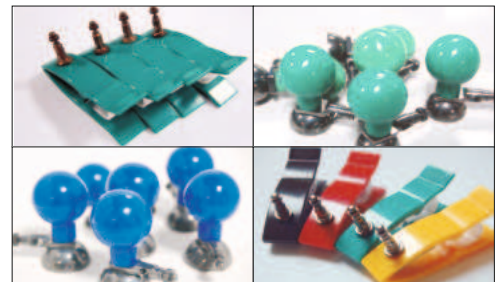

Section 03 - ECG Monitoring

ECG Electrodes

Kendall ECG Long-Term Monitoring Electrodes - Fast formula hydrogel for reduced skin impedance on application.

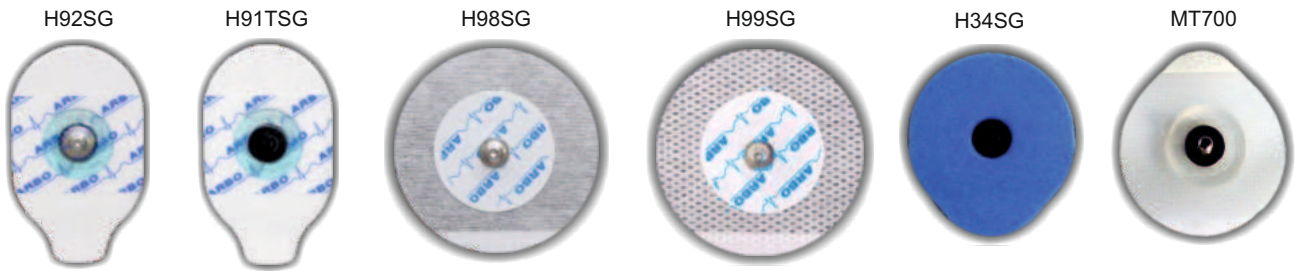

Cat No	Size (mm)	Gel	Connection	Backing	Pc/ Pouch	Pc/ Pack	Price
H92SG	48x34	Solid	Press Stud	Foam	50	500	42.00
H91TSG*	48x34	Solid	Press Stud	Foam	50	500	37.80
H98SG	55	Solid	Press Stud	Micropore	30	300	40.60
H99SG	55	Solid	Press Stud	Cloth	30	300	26.00
H34SG*	45	Solid	Press Stud	Foam	30	300	30.80
MT700	45	Solid	Press Stud	Clear Tape	50	1000	86.80

* - Suitable for X-ray, MRI and CT

Kendall ECG Long-Term Monitoring Electrodes, Smaller sizes - For paediatric, neurological and specialist applications. H59 is a full-surface electrode designed to be repositioned without sacrificing adhesion.

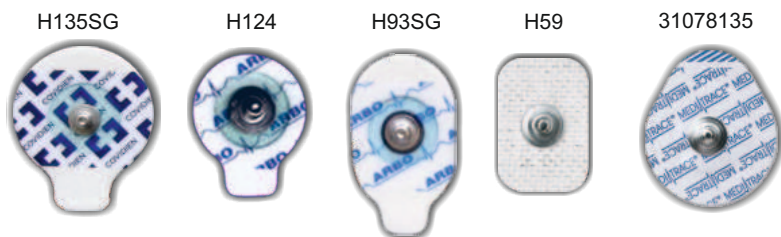

Cat No	Size (mm)	Gel	Connection	Backing	Pc/ Pouch	Pc/ Pack	Price
H135SG	30	Solid	Press Stud	Foam	50	500	40.60
H124	24	Solid	Press Stud	Foam	50	50	6.20
H93SG	35x26	Solid	Press Stud	Foam	50	500	57.40
H59	35x22	Solid	Press Stud	Cloth	30	450	126.00
31078135	35	Solid	Press Stud	Foam	30	600	43.40

Kendall ECG Short-Term Monitoring Electrodes - With particularly low skin impedance, ideal for emergency applications such as monitoring during and after defibrillation. Also suitable for stress testing.



Cat No	Size (mm)	Gel	Connection	Backing	Pc/ Pouch	Pc/ Pack	Price
H135LG	40	Liquid	Press Stud	Foam	30	300	42.00
H1354LG	40	Liquid	4mm Banana	Foam	20	200	29.25
H66LG	55	Liquid	Press Stud	Foam	30	300	40.60
H98LG	55	Liquid	Press Stud	Micropore	30	300	40.60
H99LG	55	Liquid	Press Stud	Cloth	30	300	40.60

Section 03 - ECG Monitoring

ECG Electrodes

Kendall ECG Stress and Holter Electrodes - Strong hydrogel or liquid gel adhesive.

Cat No	Size		Gel	Connection	Backing	Pc/ Pouch	Pc/ Pack	Price
	(mm)							
H91SSG	48x34		Solid	Press Stud	Foam	50	500	53.20
H34LG**	45		Liquid	Press Stud	Foam	30	300	40.60
31013926*	45		Solid	Press Stud	Foam	30	600	38.50

- * - Suitable for X-ray
- ** - Suitable for washing and showering



Kendall Diagnostic (Resting) ECG Electrodes

31433538
Q-Trace 5400



30807732
Q-Trace 5500



H914P



Cat No	Size		Gel	Connection	Backing	Pc/ Pouch	Pc/ Pack	Price
	(mm)							
31433538*	23x25		Solid	Tab	Clear Tape	100	4000	110.90
30807732*	22x31		Solid	Tab	Clear Tape	100	2000	59.30
H914P	48x34		Solid	4mm Banana	Foam	30	30	5.25

- * - Suitable for X-ray

Kendall Neonatal ECG Electrodes

H87P



H87V



H203PGT



H207PT



1041PTS

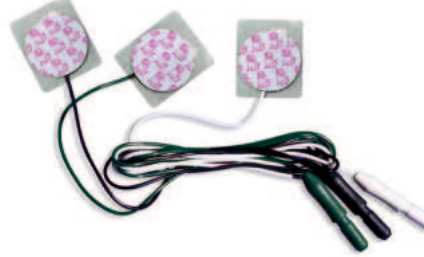

1042PTS



Cat No	Size		Gel	Connection	Leadwire Colour	Backing	Pc/ Pouch	Pc/ Pack	Price
	(mm)								
H87P	30		Polymer	1.5mm DIN, 60cm leadwire	Red, Yellow, Black	Micropore	10x3	120	62.00
H87V	30		Karaya	1.5mm DIN, 60cm leadwire	White	Micropore	10x3	120	69.00
H203PGT*	30x22		Polymer	4mm Banana, 90cm leadwire	White	Micropore	30	90	77.00
H207PT*	30x22		Polymer	1.5mm DIN, 90cm leadwire	White	Micropore	30	90	81.00
1041PTS*	25		Polymer	1.5mm DIN, 60cm leadwire	Green, Black, White	Clear Tape	3	300	130.50
1042PTS*	30x22		Polymer	1.5mm DIN, 60cm leadwire	Green, Black, White	Clear Tape	3	300	147.00

- * - Suitable for X-ray



Video Imaging Paper, Print Media

We stock a wide range of Sony Medical printing media and a selection of media from Mitsubishi.

If the product you require is not listed below, please call our team on 01707 385226 to discuss your requirements.

Minimum order quantities may apply. Please call for details.



Sony Thermal Print Media

		Pack	Price	9+	25+
UPP110S	NORMAL HIGH QUALITY 110 x 20mm, 215 PRINTS PER ROLL	Roll	8.25	6.80	6.42
UPP110HD	HIGH DENSITY QUALITY 110 x 20mm, 215 PRINTS PER ROLL	Roll	18.49	16.10	15.00
UPP110HA	ENHANCED SUPERIOR DENSITY 110 x 20mm, 215 PRINTS PER ROLL	Roll	13.25	12.50	12.05
UPP110HG	HIGH GLOSS 110 x 20mm, 215 PRINTS PER ROLL	Roll	17.99	16.10	15.00
UPP210SE	NORMAL HIGH QUALITY 210 x 25mm, 139 PRINTS PER ROLL	Roll	23.65		
UPP210HD	HIGH DENSITY QUALITY 210 x 25mm, 139 PRINTS PER ROLL	Roll	30.55		
UPP725	THERMAL PRINTING PAPER 203 x 254mm, FOR C-ARM	100 Sheets	113.10		

Sony Blue Thermal Film

		Pack	Price		
UPT210BL	BLUE TRANSPARENT THERMAL FILM 210 x 12.5mm, 42 PRINTS PER ROLL	Roll	40.85		
UPT510BL	BLUE THERMAL FILM 202 x 253mm	125 Sheets	130.50		
UPT512BL	BLUE THERMAL FILM 253 x 304mm	125 Sheets	181.25		
UPT514BL	BLUE THERMAL FILM 279 x 354mm	125 Sheets	224.75		
UPT517BL	BLUE THERMAL FILM 354 x 431mm	125 Sheets	319.00		
UPT735BL	BLUE TRANSPARENT THERMAL FILM 203 x 254mm	100 Sheets	137.75		
UPT736BL	BLUE THERMAL FILM 203 x 254mm	100 Sheets	137.75		
UPTM710BL	BLUE TRANSPARENT THERMAL FILM 203 x 254mm	125 Sheets	217.50		
UPTM712BL	BLUE TRANSPARENT THERMAL FILM 253 x 304mm	125 Sheets	217.50		

Sony Colour Printer Packs

		Pack	Price		
UPC21S	COLOUR PRINT PACK, PAPER 100 x 90mm, 3 RIBBONS	240 Sheets	85.75		
UPC21L	COLOUR PRINT PACK, PAPER 144 x 100mm, 4 RIBBONS	200 Sheets	121.65		
UPC55	COLOUR PRINT PACK, PAPER 178 x 152mm, 2 RIBBONS	200 Sheets	217.50		
UPC510	COLOUR PRINT PACK, PAPER 216 x 152mm, RIBBON FOR 200 PRINTS	200 Sheets	230.00		
UPC770	SELF LAMINATING COLOUR PRINT PACK, PAPER 210 x 298mm (A4), 1 RIBBON	72 Sheets	188.50		
UPCR80MD	SELF LAMINATING COLOUR PRINT PACK, PAPER 210 x 16mm, 50 A4 PRINTS PER ROLL, 2 RIBBONS	Roll	174.00		

Mitsubishi Thermal Print Media

		Pack	Price	9+	25+
K61B	SUPER GRADE PAPER 110 x 20mm, 215 PRINTS PER ROLL	Roll	6.75	6.35	5.95
K65HM	HIGH DENSITY PAPER 110 x 20mm, 215 PRINTS PER ROLL	Roll	18.85	18.25	
K91HG	HIGH GLOSS PAPER 110 x 20mm, 215 PRINTS PER ROLL	Roll	12.85	12.45	11.85

ECG Gels, Creams, Sprays, Prep Pastes and Pads

SPECTRA® 360 - The only salt-free and chloride-free electrically conductive gel, recommended for all electromedical procedures. Salt-free characteristics make it particularly suitable for long-term applications. Spectra 360 differs significantly from all other electrically conductive media...it works by wetting the skin, thereby reducing skin resistance.

SIGNAGEL® - Highly conductive, multi-purpose electrolyte meets all the standards of the ideal saline electrode gel. Recommended for ECG, defibrillation, biofeedback and EMG.

SIGNACREME® - Highly conductive cream electrolyte for use in electromedical procedures where a cosmetic quality cream is preferred.

SIGNASPRAY® - Highly conductive, economical spray electrolyte and non-gritty skin prep.

REDUX® - The range includes a water-soluble non-abrasive electrolyte gel for routine ECG and defibrillation, a cosmetic quality electrolyte cream for routine ECG and a water-soluble abrasive paste for short-term monitoring, ECG and defibrillation.



Cat No		Pack	Price	6+	12+
HM36	PARKER SPECTRA 360 GEL 60g BLUE	12	17.95	16.95	16.35
HM35	PARKER SPECTRA 360 GEL 250g BLUE	12	26.15	25.35	24.50
HM63	PARKER SIGNA GEL 60g GREEN	12	17.95	16.95	16.35
HM54	PARKER SIGNA GEL 250g GREEN	12	33.45	31.70	30.40
HM38	PARKER SIGNACREME 140g	12	27.75	26.75	25.95
Cat No		Pack	Price	12+	24+
HM39	PARKER SIGNACREME 2lt	Each	20.05	19.50	18.45
HM55	PARKER SIGNA SPRAY CLEAR 250ml	12	36.00	35.00	34.00
Cat No		Pack	Price	6+	12+
HM58	PARKER REDUX ELECTROLYTE PASTE 140g	10	23.45	22.40	21.40
HM59	PARKER REDUX ELECTROLYTE CREAM 112g	10	23.45	22.40	21.40
HM60	PARKER REDUX ELECTROLYTE GEL 112g	10	23.45	22.40	21.40

Section 04 - Pulse Oximetry

SpO₂ Sensors & Accessories

- Full range of sensors and extension cables
- Adult, paediatric & neonatal
- Finger clips
- Rubber boots
- Ear clips
- Wraps
- Adhesive & non-adhesive disposables
- 1 year warranty
- Reusable sensors from £33.33 each
- Disposable sensors from £8.64 each
- Extension cables from £24.69 each

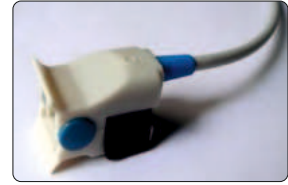

For a full listing please call our Customer Care Team on 01707 385226

Pulse Oximeters



Cat No		Pack	Price
UC60B	FINGERTIP OXIMETER	Each	77.15
UC66B	HANDHELD OXIMETER	Each	231.50
UC68B	WRIST OXIMETER	Each	257.00



Section 05 - Patient Monitoring

CAS 740SELECT™ Vital Signs Monitor

CASMED's 740SELECT™ Series Vital Signs Monitor defines intelligent monitoring, providing flexible solutions and high-end performance in a simple yet highly sophisticated platform.

Adapting the 740SELECT to the immediate need of your patient is easy thanks to advanced work flow and alarm management for spot-checking, triage or continuous monitoring.

Timely and accurate collection of patient physiologic measurements is accomplished using world class vital signs technologies (CASMED MAXNIBP®, Covidien™ FILAC 3000 Temperature, and Masimo® SET or Nellcor OxiMax SpO₂).

When increased vigilance is required, the 740SELECT supports continuous SpO₂ and PR monitoring with high and low alarms, plethysmograph waveform, automatic non-invasive blood pressure measurements (STAT and Timed Interval), automatic trends capture and printing on alarm. Recent physiologic and equipment alarms, as well as alarm limit changes can be recalled using the easy access 740SELECT Alarm Log.

Workflow features such as Standby Mode, Barcode Reader, SpO₂ Alarms Acknowledge, Screen Lock and Secondary Audio Alerts are provided to complement hospital care management and patient safety protocols.

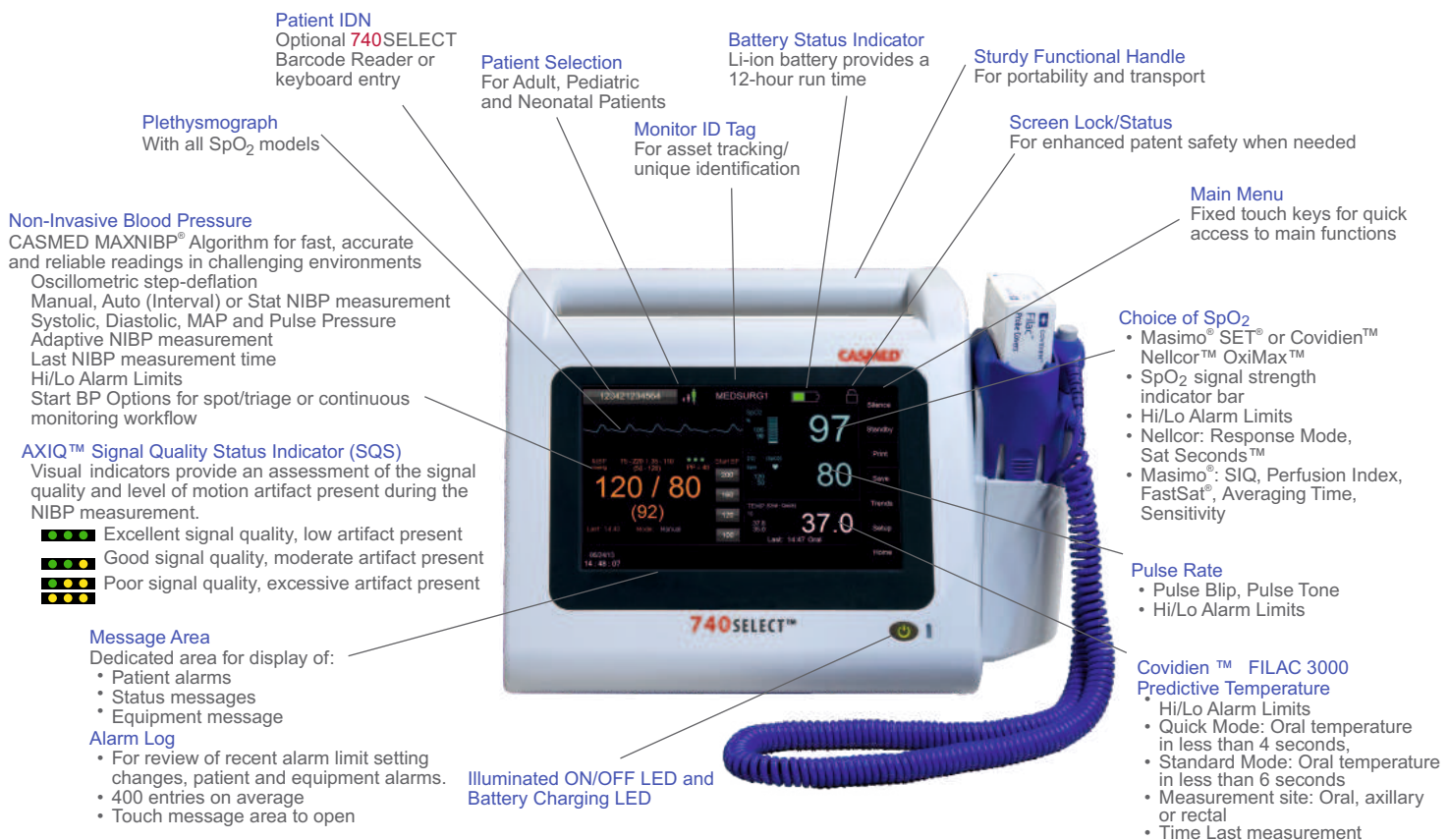

Cat No		Pack	Price
01021000	MAXNIBP	Each	2142.18
01021001	MAXNIBP AND MASIMO SET SPO2	Each	3038.93
01021002	MAXNIBP AND NELLCOR OXIMAX SPO2	Each	3038.93
01021003	MAXNIBP, MASIMO SET SPO2 AND COVIDIEN FILAC 3000 TEMPERATURE	Each	3222.08
01021004	MAXNIBP, NELLCOR OXIMAX SPO2 AND COVIDIEN FILAC 3000 TEMPERATURE	Each	3222.08
01020172G	MOBILE STAND (REQUIRES KIT 01020821)	Each	322.29
01020821	MOBILE STAND ACCESSORY KIT (REQUIRED FOR 01020172G)	Each	192.50
01020807	EXTERNAL PRINTER	Each	532.98
01020820	EXTERNAL PRINTER MOUNTING KIT (FOR ATTACHMENT TO 01020172G)	Each	49.75
01020815	BARCODE SCANNER WITH 14' COILED USB CABLE	Each	743.06
01020817	EXTERNAL BARCODE SCANNER MOUNTING KIT (FOR ATTACHMENT TO 01020172G)	Each	187.61

Section 06 - Infusion Products

Unifusor Infusion Cuffs

Designed for rapid IV infusion, invasive pressure monitoring and autotransfusion procedures, the Unifusor line is the clear choice in pressure infusors. There are three models available: Unifusor (with aneroid gauge), Unifusor Classic (with piston gauge) and Unifusor Plus (reusable), in three different sizes - 500cc, 1000cc and 3000cc.



Aneroid gauge



Stopcock valve



Piston gauge



Thumbwheel valve



Cat No		Pack	Price
803FGA24	UNIFUSOR THUMBWHEEL ANEROID 500cc	24	348.00
804FGA24	UNIFUSOR THUMBWHEEL ANEROID 1000cc	24	372.00
805FGA10	UNIFUSOR THUMBWHEEL ANEROID 3000cc	10	190.00
803SGA24	UNIFUSOR STOPCOCK ANEROID 500cc	24	348.00
804SGA24	UNIFUSOR STOPCOCK ANEROID 1000cc	24	372.00
805SGA10	UNIFUSOR STOPCOCK ANEROID 3000cc	10	190.00
903TGA24	UNIFUSOR CLASSIC THUMBWHEEL PISTON 500cc	24	348.00
904TGA24	UNIFUSOR CLASSIC THUMBWHEEL PISTON 1000cc	24	348.00
905TGA10	UNIFUSOR CLASSIC THUMBWHEEL PISTON 3000cc	10	372.00
903SGA24	UNIFUSOR CLASSIC STOPCOCK PISTON 500cc	24	372.00
904SGA24	UNIFUSOR CLASSIC STOPCOCK PISTON 1000cc	24	190.00
905SGA10	UNIFUSOR CLASSIC STOPCOCK PISTON 3000cc	10	190.00
1103	UNIFUSOR PLUS WITH TRIGGER AIR CONTROL INFLATOR 500cc	Each	100.00
110305	UNIFUSOR PLUS WITH TRIGGER AIR CONTROL INFLATOR 500cc	5	475.00
1104	UNIFUSOR PLUS WITH TRIGGER AIR CONTROL INFLATOR 1000cc	Each	105.00
110405	UNIFUSOR PLUS WITH TRIGGER AIR CONTROL INFLATOR 1000cc	5	500.00
1105	UNIFUSOR PLUS WITH TRIGGER AIR CONTROL INFLATOR 3000cc	Each	110.00
110505	UNIFUSOR PLUS WITH TRIGGER AIR CONTROL INFLATOR 3000cc	5	525.00
1103X	UNIFUSOR PLUS CUFF ONLY 500cc	Each	9.00
1103X05	UNIFUSOR PLUS CUFF ONLY 500cc	5	42.50
1104X	UNIFUSOR PLUS CUFF ONLY 1000cc	Each	11.00
1104X05	UNIFUSOR PLUS CUFF ONLY 1000cc	5	52.50
1105X	UNIFUSOR PLUS CUFF ONLY 3000cc	Each	15.00
1105X05	UNIFUSOR PLUS CUFF ONLY 3000cc	5	72.50
1199	UNIFUSOR PLUS REUSABLE TRIGGER AIR CONTROL INFLATOR	Each	100.00
119905	UNIFUSOR PLUS REUSABLE TRIGGER AIR CONTROL INFLATOR	5	475.00

Unifusor features

- IV pole loop
- Fluid bag hook
- Disposable white nylon (Unifusor, Unifusor Classic) or reusable blue nylon (Unifusor Plus)
- Reinforced sleeve
- Can read through the translucent sleeve
 - a) type of fluid
 - b) fluid levels
- No-crimp tubing
- Palm-fitted handbulb
- Thumbwheel air control or a leak-proof stopcock valve
- Aneroid gauge (Unifusor) or piston gauge (Unifusor Classic)
- 100% leak tested during manufacturing

Unimed Pressure Infusion Cuffs



Unimed infusion cuffs are supplied in 3 styles: disposable (with stopcock valve and piston gauge), semi-reusable (with stopcock valve and manometer) and reusable (with stopcock valve and manometer).

Cat No		Pack	Price
DPI500	DISPOSABLE PRESSURE INFUSION BAG 500ml	20	272.00
DP11000	DISPOSABLE PRESSURE INFUSION BAG 1000ml	15	259.20
HPI500	SEMI-REUSABLE PRESSURE INFUSION BAG 500ml	20	345.60
HP11000	SEMI-REUSABLE PRESSURE INFUSION BAG 1000ml	15	333.33
PI500	REUSABLE INFUSION BAG 500ml	20	493.80
PI1000	REUSABLE INFUSION BAG 1000ml	15	444.75

Accoson Infusion Cuffs

The Accoson pressure infusion cuff features a large-scale accurate pressure gauge, simple switch valve for rapid deflation and a strong fine-mesh front for excellent visibility. Fine adjustment of air pressure is available by using the adjustment valve on the pressure gauge.



Cat No		Pack	Price
AC0205	PRESSURE INFUSION CUFF 0.5Lt	Each	35.10
AC0210	PRESSURE INFUSION CUFF 1.0Lt	Each	36.40
AC0230	PRESSURE GAUGE ONLY	Each	22.75
AC1922	PRESS VALVE FOR BULB	Each	2.95
AC1925	THUMB SCREWS FOR GAUGE	10	3.50
AC1918	TUBING SET	Each	0.84
AC1924	0.5Lt INFUSION CUFF ONLY	Each	12.05
AC1923	1.0Lt INFUSION CUFF ONLY	Each	12.60

Infusion Stand

Height adjustable from 120cm - 210cm. Safety hooks for infusion bags/bottles. Highly stable five-caster mobile base or wall mount. Height adjustable drip vessel. Four models available; stainless steel, heavy stainless steel, chrome plated or wall mounted stainless steel.



Cat No		Pack	Price
0911005002	INFUSION STAND, MOBILE, STAINLESS STEEL	Each	57.06
0911010002	INFUSION STAND, MOBILE, STAINLESS STEEL, HEAVY	Each	115.93
0911800002	INFUSION STAND, MOBILE, CHROME PLATED	Each	40.76
0912000002	INFUSION STAND, WALL MOUNTED, STAINLESS STEEL	Each	40.76



3M™ Littmann® Stethoscopes



3M™ LITTMANN® Electronic Stethoscope Model 3200 - 12-Track Zargis® StethAssist™ Heart and Lung Sound Visualization Software

Designed to visualize what you are hearing, allow playback when convenient, facilitate storage of sounds in patient records or transfer to colleagues for further analysis. Zargis® StethAssist™ software connects wirelessly to the Bluetooth-enabled Littmann Model 3200 stethoscope for easy, real-time analysis. Display and print sounds as a phonocardiogram, save patient information for future comparison or send as an e-mail attachment. Now records and stores 12 separate sound tracks for use on multiple patients on multiple sites with no need to download each sound track to your PC each time you record. Ability to add comments to tracks for identification purposes. 2-year warranty.

Cat No	Pack	Price
3200BK12	3M LITTMANN ELECTRONIC, BLACK 27" TUBING	Each 330.00



3M™ LITTMANN® Electronic Stethoscope Model 3100

Incredibly simple. Non-disruptive to your auscultation workflow. The Littmann 3100 is easy to use for quick auscultation every time. The easy-to-read backlit LCD display includes frequency selection, sound level, remaining battery life and your patient's heart rate. It has been designed to ensure comfort and durability for everyday use, weighing about the same as a cardiologist-grade acoustic stethoscope. You can auscultate immediately, thanks to our instant-on technology and the stethoscope stays in battery-saving "sleep mode" until you start your next auscultation. The Littmann Model 3100 offers improved sound quality and ease of use to help you make a clear diagnosis, every time. 2-year warranty.

Cat No	Pack	Price
3100BK27	3M LITTMANN ELECTRONIC, BLACK 27" TUBING	Each 268.50



3M™ LITTMANN® Master Cardiology Stethoscopes

The ultimate acoustic stethoscope. The unique patented single-sided chestpiece allows the clinician to monitor both high and low frequencies by simply alternating the pressure on the chestpiece. This stethoscope allows accurate and efficient auscultation without the need to turn over the chestpiece between the bell and diaphragm modes, as in the traditional combination stethoscopes. Double-lumen tubing enhances the acoustic sensitivity. 7-year warranty.

Cat No	Pack	Price
2160	3M LITTMANN MASTER CARDIOLOGY, BLACK 27" TUBING	Each 171.00
2175	3M LITTMANN MASTER CARDIOLOGY BRASS FINISH CHESTPIECE AND EARTUBE, BLACK 27" TUBING	Each 171.00
2176	3M LITTMANN MASTER CARDIOLOGY SMOKE FINISH CHESTPIECE AND EARTUBE, BLACK 27" TUBING	Each 171.00



3M™ LITTMANN® Cardiology S.T.C. Stethoscope

High-end auscultation with an innovative design and shape. Outstanding Littmann stethoscope acoustic quality offers excellent high and low frequency responses. The unique, oval, patented chestpiece shape is easy to grasp and allows easy movement between auscultation sites and also has a patient-friendly non-chill rim. Patented single-sided tunable diaphragm provides both high and low frequency responses. Dual lumen tubing helps to eliminate noise artifact. Anatomically correct headset. Soft, oval touch chestpiece grip eliminates friction interference sounds. 6-year warranty.

Cat No	Pack	Price
4471	3M LITTMANN CARDIOLOGY STC, BLACK 27" TUBING	Each 176.70



3M™ LITTMANN® Cardiology III Stethoscopes

These stethoscopes are very innovative in auscultation technology. There are two patented tunable diaphragms, allowing you to listen to both low and high frequency sounds with either side of the chestpiece. The large side can be used for auscultating normal patients while the small side is especially useful with paediatric or thin patients. The smaller diaphragm can also be converted to a traditional bell by replacing with the non-chill rim (supplied). Double-lumen tubing enhances the acoustic sensitivity. 5-year warranty.

Cat No	Pack	Price
3128	3M LITTMANN CARDIOLOGY III BLACK 27" TUBING	Each 148.50
3128BRS	3M LITTMANN CARDIOLOGY III BRASS FINISH CHESTPIECE AND EARTUBE, BLACK 27" TUBING	Each 148.50
3131BE	3M LITTMANN CARDIOLOGY III SMOKE FINISH CHESTPIECE AND EARTUBE, BLACK 27" TUBING	Each 148.50



3M™ LITTMANN® Traditional Stethoscopes

The Traditional stethoscope provides outstanding acoustic performance combined with exceptional versatility. The tunable technology of the Traditional stethoscope allows physicians to hear low and high frequency sounds without the need to rotate the chestpiece. The newly designed deep open bell provides added focus on low frequency sounds. 5-year warranty.

Cat No	Pack	Price
3141	3M LITTMANN TRADITIONAL, BLACK 27" TUBING	Each 148.50



3M™ LITTMANN® Master Classic II Stethoscopes

The portable high performance stethoscope. The 3M patented single-sided Master chestpiece allows the clinician to monitor both high and low frequencies by simply alternating the pressure applied to the chestpiece. Comfortable, durable and portable. 3-year warranty.

Cat No	Pack	Price
2144L	3M LITTMANN MASTER CLASSIC II, BLACK 27" TUBING	Each 78.00



3M™ LITTMANN® Classic II S.E. Stethoscopes

The standard of the health care profession, features the 3M patented dual-frequency diaphragm, allowing the clinician to monitor both high and low frequencies by simply alternating the pressure on the chestpiece. This is a double-sided stethoscope with both a tuneable diaphragm and conventional bell mode. 3-year warranty.

Cat No	Pack	Price
2201B	3M LITTMANN CLASSIC II SE, BLACK 28" TUBING	Each 59.00
2201BRS	3M LITTMANN CLASSIC II S.E. BRASS FINISH CHESTPIECE AND EARTUBE, BLACK 28" TUBING	Each 59.00

Section 07 - Stethoscopes

3M™ Littmann® Stethoscopes - Continued

3M™ LITTMANN® Classic II Paediatric Stethoscopes

These stethoscopes are optimally designed for paediatric auscultation, with a 2.9cm dia diaphragm and 2.5cm dia bell. They are designed to offer the same high quality performance as the standard Littmann Classic II stethoscopes. 3-year warranty.

Cat No	Pack	Price
2113	3M LITTMANN CLASSIC II PAEDIATRIC, BLACK 28" TUBING	Each 68.95

3M™ LITTMANN® Classic II Infant Stethoscopes

These stethoscopes are optimally designed for infant auscultation with a 2.7cm dia diaphragm and 1.9cm bell. They are designed to offer the same high quality performance as the standard Littmann Classic II stethoscopes. 3-year warranty.

Cat No	Pack	Price
2114	3M LITTMANN CLASSIC II INFANT, BLACK 27" TUBING	Each 68.95

3M™ LITTMANN® Classic III Stethoscopes

The next generation of a clinical icon. Features and benefits include high acoustic sensitivity, tunable diaphragms, single piece diaphragm, open bell versatility, next generation tubing, precision engineered chestpiece. 5-year warranty.

Cat No	Pack	Price
5620	3M LITTMANN CLASSIC III, BLACK 27" TUBING	Each 74.70

3M™ LITTMANN® Select Stethoscopes

Designed to meet nurses' and technicians' daily auscultation needs. The Littmann Select stethoscope offers single-sided listening for both low or high frequencies. 2-year warranty.

Cat No	Pack	Price
2290	3M LITTMANN SELECT, BLACK 27" TUBING	Each 38.50

3M™ LITTMANN® Lightweight II SE Stethoscopes

Designed to meet the needs of nursing professionals. An excellent, affordable choice for blood pressure and patient assessment. Provides clear, reliable acoustic performance through soft-sealing eartips and ovoid chestpiece for better orientation. Benefits from a tunable diaphragm for easy low- and high-frequency monitoring. 2-year warranty.

Cat No	Pack	Price
2450	3M LITTMANN LIGHTWEIGHT II SE, BLACK 27" TUBING	Each 37.00

3M™ LITTMANN® Teaching Stethoscopes

This stethoscope is the same design as the Classic II SE, with two headset joined to the chestpiece, for use in teaching applications where two people can hear the same sounds. 3-year warranty.

Cat No	Pack	Price
2138	3M LITTMANN TEACHING, BLACK 27" TUBING	Each 89.00



Henley Stethoscopes



Disposable Stethoscopes are suitable for basic applications and help to reduce the risk of cross-infection.

Nurse-Style Stethoscopes are a cost-effective solution suitable for general use, available in either single- or dual-head.

Classic Stethoscopes are very high quality and suitable for a wide range of applications.

Sprague Rappaport Stethoscopes use a 2-in-1 tube system and are designed to detect the entire range of heart and chest auscultation.

Cardiology Stethoscopes are very high quality and designed to detect the entire range of heart and chest auscultation.

Cat No	Pack	Price
SF601Y	DISPOSABLE YELLOW	Each 1.05
SF100BLK	NURSE-STYLE SINGLE-HEAD BLACK	Each 3.15
SF100R	NURSE-STYLE SINGLE-HEAD RED	Each 3.15
SF100GY	NURSE-STYLE SINGLE-HEAD GREY	Each 3.15
SF100LB	NURSE-STYLE SINGLE-HEAD LIGHT BLUE	Each 3.15
SF100G	NURSE-STYLE SINGLE-HEAD GREEN	Each 3.15
SF200BLK	NURSE-STYLE DUAL-HEAD BLACK	Each 3.15
SF200R	NURSE-STYLE DUAL-HEAD RED	Each 3.15
SF200GY	NURSE-STYLE DUAL-HEAD GREY	Each 2.60
SF200LB	NURSE-STYLE DUAL-HEAD LIGHT BLUE	Each 3.15
SF200G	NURSE-STYLE DUAL-HEAD GREEN	Each 3.15
SF201BLK	PAEDIATRIC DUAL-HEAD BLACK	Each 3.15
SF201R	PAEDIATRIC DUAL-HEAD RED	Each 3.15
SF201GY	PAEDIATRIC DUAL-HEAD GREY	Each 3.15
SF201LB	PAEDIATRIC DUAL-HEAD LIGHT BLUE	Each 3.15
SF201G	PAEDIATRIC DUAL-HEAD GREEN	Each 3.15
SF203BLK	FOETAL DUAL-HEAD BLACK	Each 3.15
SF203R	FOETAL DUAL-HEAD RED	Each 3.15

Cat No	Pack	Price
SF203GY	FOETAL DUAL-HEAD GREY	Each 3.15
SF203LB	FOETAL DUAL-HEAD LIGHT BLUE	Each 3.15
SF203G	FOETAL DUAL-HEAD GREEN	Each 3.15
SF501BLK	STAINLESS STEEL CARDIOLOGY BLACK	Each 31.50
SF501R	STAINLESS STEEL CARDIOLOGY RED	Each 31.50
SF501GY	STAINLESS STEEL CARDIOLOGY GREY	Each 31.50
SF501LB	STAINLESS STEEL CARDIOLOGY LIGHT BLUE	Each 31.50
SF501G	STAINLESS STEEL CARDIOLOGY GREEN	Each 31.50
SF502BLK	STAINLESS STEEL CLASSIC BLACK	Each 26.25
SF502R	STAINLESS STEEL CLASSIC RED	Each 26.25
SF502GY	STAINLESS STEEL CLASSIC GREY	Each 26.25
SF502LB	STAINLESS STEEL CLASSIC LIGHT BLUE	Each 26.25
SF502G	STAINLESS STEEL CLASSIC GREEN	Each 26.25
SF301BLK	SPRAGUE RAPPAPORT-TYPE BLACK	Each 10.50
SF301R	SPRAGUE RAPPAPORT-TYPE RED	Each 10.50
SF301GY	SPRAGUE RAPPAPORT-TYPE GREY	Each 10.50
SF301LB	SPRAGUE RAPPAPORT-TYPE LIGHT BLUE	Each 10.50
SF301G	SPRAGUE RAPPAPORT-TYPE GREEN	Each 10.50



KaWe EUROLIGHT® Oscopes



The high-quality metal housing of the KaWe EUROLIGHT® product line makes the compact instruments practically indestructible. With this instrument you are not only choosing excellent quality but also high durability. Your long-lasting companion for ear, nose and throat diagnostics, is also available with high-quality distal fibre-optics (F.O.) in 2.5v or 3.5v in connection with a high-capacity xenon light or with standard illumination C and guarantees a bright illumination free of reflection of the tympanum and auditory canal. The light strength can be easily regulated with the rheostat (except for the LED). A further advantageous feature is the pivoting magnifying glass with 2, 2.5 or 3-fold magnification. KaWe EUROLIGHT® is also available with automatic click-on or screw-on connection.

Oscopes with Handles & Zipper Bag

Cat No	Otoscope Head	Illumination	Connection	Handle Type	Voltage	Pack	Price
0111110001	C10	STANDARD	SCREW	C-CELL	2.5v	Each	48.07
0111130001	C30	STANDARD	CLICK-ON	C-CELL	2.5v	Each	66.50
0111534001	C30 OP	F.O. LED	CLICK-ON	C-CELL	2.5v	Each	88.14
0111330001	F.O.30	F.O. XENON	CLICK-ON	C-CELL	2.5v	Each	112.97
0111530002	F.O.30 LED	F.O. LED	CLICK-ON	C-CELL	2.5v	Each	120.18
0111430101	F.O.30	F.O. XENON	CLICK-ON	MEDCHARGE 4000	3.5v	Each	151.43
0111830101	F.O.30 LED	F.O. LED	CLICK-ON	MEDCHARGE 4000	3.5v	Each	172.26



EUROLIGHT® C10



EUROLIGHT® C30



EUROLIGHT® C30 OP



EUROLIGHT® F.O. 30



EUROLIGHT® F.O. 30 LED

Otoscope Heads

Cat No	Otoscope Head	Illumination	Connection	Voltage	Pack	Price
0173110001	C10	STANDARD	SCREW	2.5v	Each	28.84
0173131001	C30	STANDARD	CLICK-ON	2.5v	Each	37.66
0173134501	C30 OP	F.O. LED	CLICK-ON	2.5v	Each	76.12
0173135001	F.O.30	F.O. XENON	CLICK-ON	2.5v	Each	88.94
0173135501	F.O.30 LED	F.O. LED	CLICK-ON	2.5v	Each	93.89
0173136001	F.O.30	F.O. XENON	CLICK-ON	3.5v	Each	93.89
0173137611	F.O.30 LED	F.O. LED	CLICK-ON	3.5v	Each	116.18

KaWe COMBILIGHT® Oscopes



Technologically-mature and tested for years, here KaWe is also committed to excellence and combines high-quality fibre optics with high-power 2.5v or 3.5v xenon light for especially bright and white light. The KaWe COMBILIGHT® optimally illuminates the auditory canal and the eardrum and helps you make an accurate diagnosis. The housing is robust and they operate reliably. Oscopes from the KaWe COMBILIGHT® product line have an excellent cost/performance ratio.

Oscopes with Handles & Zipper Bag

Cat No	Otoscope Head	Illumination	Connection	Handle Type	Voltage	Pack	Price
0112110001	C10	STANDARD	SCREW	C-CELL	2.5v	Each	37.56
0112330001	F.O.30	F.O. XENON	CLICK-ON	C-CELL	2.5v	Each	80.12
0112530002	F.O.30 LED	F.O. LED	CLICK-ON	C-CELL	2.5v	Each	87.30
0112430101	F.O.30	F.O. XENON	CLICK-ON	MEDCHARGE 4000	3.5v	Each	120.18
0112830101	F.O.30 LED	F.O. LED	CLICK-ON	MEDCHARGE 4000	3.5v	Each	136.21



COMBILIGHT® C10



COMBILIGHT® F.O. 30



COMBILIGHT® F.O. 30 LED

Otoscope Heads

Cat No	Otoscope Head	Illumination	Connection	Voltage	Pack	Price
0173210021	C10	STANDARD	SCREW	2.5v	Each	21.78
0173230021	F.O.30	F.O. XENON	CLICK-ON	2.5v	Each	50.48
0173230521	F.O.30 LED	F.O. LED	CLICK-ON	2.5v	Each	56.09
0173232021	F.O.30	F.O. XENON	CLICK-ON	3.5v	Each	56.09
0173232631	F.O.30 LED	F.O. LED	CLICK-ON	3.5v	Each	78.52

Section 08 - Ophthalmic / ENT

KaWe PICCOLIGHT® Oscopes

The proven LED KaWe PICCOLIGHT® F.O. otoscopes provide you with optimal conditions for easy ENT treatment through high-quality light technology. The LED illuminant has excellent light efficiency and very high light transmission. LED illuminants are sure to please with their long working lives and very robust design. The xenon illumination of KaWe PICCOLIGHT® F.O. otoscopes that you already own can be converted to LED-illumination simply by replacing the bulb.



Otoscope Head with Handle & Cloth Bag

Cat No	Otoscope Head	Illumination	Colour	Connection	Handle Type	Voltage	Pack	Price
0113100021	C	STANDARD	BLACK	SCREW	AA-CELL	2.5v	Each	35.25
0113100232	C	STANDARD	BLUE	SCREW	AA-CELL	2.5v	Each	35.25
0113100262	C	STANDARD	WHITE	SCREW	AA-CELL	2.5v	Each	35.25
0113300021	F.O.	F.O. XENON	BLACK	SCREW	AA-CELL	2.5v	Each	48.88
0113300232	F.O.	F.O. XENON	BLUE	SCREW	AA-CELL	2.5v	Each	48.88
0113300262	F.O.	F.O. XENON	WHITE	SCREW	AA-CELL	2.5v	Each	48.88
0113500021	F.O. LED	F.O. LED 8K LUX	BLACK	SCREW	AA-CELL	2.5v	Each	56.09
0113500232	F.O. LED	F.O. LED 8K LUX	BLUE	SCREW	AA-CELL	2.5v	Each	56.09
0113500262	F.O. LED	F.O. LED 8K LUX	WHITE	SCREW	AA-CELL	2.5v	Each	56.09
0113600021	F.O. LED HIGH POWER	F.O. LED 20K LUX	BLACK	SCREW	AA-CELL	2.5v	Each	88.14
0113600232	F.O. LED HIGH POWER	F.O. LED 20K LUX	BLUE	SCREW	AA-CELL	2.5v	Each	88.14
0113600262	F.O. LED HIGH POWER	F.O. LED 20K LUX	WHITE	SCREW	AA-CELL	2.5v	Each	88.14

Otoscope Heads



Cat No	Otoscope Head	Illumination	Colour	Connection	Voltage	Pack	Price
0173300021	C	STANDARD	BLACK	SCREW	2.5v	Each	23.24
0173300231	C	STANDARD	BLUE	SCREW	2.5v	Each	23.24
0173300261	C	STANDARD	WHITE	SCREW	2.5v	Each	23.24
0173310021	F.O.	F.O. XENON	BLACK	SCREW	2.5v	Each	37.66
0173310231	F.O.	F.O. XENON	BLUE	SCREW	2.5v	Each	37.66
0173310261	F.O.	F.O. XENON	WHITE	SCREW	2.5v	Each	37.66
0173520021	F.O. LED	F.O. LED 8K LUX	BLACK	SCREW	2.5v	Each	45.67
0173520231	F.O. LED	F.O. LED 8K LUX	BLUE	SCREW	2.5v	Each	45.67
0173520261	F.O. LED	F.O. LED 8K LUX	WHITE	SCREW	2.5v	Each	45.67
0173530021	F.O. LED HIGH POWER	F.O. LED 20K LUX	BLACK	SCREW	2.5v	Each	79.32
0173530231	F.O. LED HIGH POWER	F.O. LED 20K LUX	BLUE	SCREW	2.5v	Each	79.32
0173530261	F.O. LED HIGH POWER	F.O. LED 20K LUX	WHITE	SCREW	2.5v	Each	79.32

KaWe Otoscope Accessories

Ear Tips for EUROLIGHT F.O. / COMBILIGHT F.O. / PICCOLIGHT

Cat No	Type	Size	Pack	Price
0171211002	DISPOSABLE	2.5mm	1000	32.85
0171212001	DISPOSABLE	2.5mm	10 Strips of 100	40.06
0171221002	DISPOSABLE	4.0mm	1000	32.85
0171222001	DISPOSABLE	4.0mm	10 Strips of 100	40.06
0172212001	REUSABLE	2.5mm	10	4.60
0172213001	REUSABLE	4.0mm	10	4.60

Ear Tips for EUROLIGHT C10 & C30 / COMBILIGHT C10

Cat No	Type	Size	Pack	Price
0171111002	DISPOSABLE	2.5mm	1000	39.74
0171112001	DISPOSABLE	2.5mm	10 Strips of 100	47.91
0171121002	DISPOSABLE	4.0mm	1000	39.74
0171122001	DISPOSABLE	4.0mm	10 Strips of 100	47.91
0172102001	REUSABLE	2.5mm	3	7.92
0172103001	REUSABLE	3.5mm	3	7.92
0172104001	REUSABLE	4.5mm	3	7.92

Ear Tips for EUROLIGHT C30 OP

Cat No	Type	Size	Pack	Price
0172106001	REUSABLE	2.5/3.5/4.5/5.5/9.0mm	5	14.40

Disposable Ear Tips



Ear Tips in Strips



Pneumatic Puffer



Nose Spreader



Puffer Adaptor



Cat No	Type	Size	Pack	Price
0178502001	PNEUMATIC PUFFER		Each	6.57
0178501001	PUFFER ADAPTOR FOR EUROLIGHT F.O. / COMBILIGHT F.O. / PICCOLIGHT		Each	3.61
0179202001	NOSE SPREADER SPECULUM		Each	15.22
0178102001	TABLE STAND FOR PICCOLIGHT, TRANSPARENT		Each	4.41
0178101001	TABLE STAND FOR EUROLIGHT / COMBILIGHT, TRANSPARENT		Each	5.61



Table Stands



KaWe EUROLIGHT® Ophthalmoscopes



KaWe ophthalmoscopes are sure to please due to their precise and shadow-free illumination of the fundus of the eye. With unique technology – the wide aperture angle of the illumination optics – the examiner is able to see a large area while at a very close proximity to the subject. The ophthalmoscope heads of the KaWe EUROLIGHT® have one, five or six apertures. The handles take either KaWe EUROLIGHT® 2.5v series batteries or rechargeable batteries. Your own individual diagnostic set can be assembled entirely according to your individual preferences. KaWe ophthalmoscopes are compliant with EN ISO 10942 standards.

Ophthalmoscope with Handle & Zipper Bag

Ophthalmoscope							
Cat No	Head	Illumination	Aperture	Connection	Handle Type	Voltage	Pack Price
0121100001	E10	STANDARD	1	SCREW	C-CELL	2.5v	Each 74.51
0121300001	E30	STANDARD	1	CLICK-ON	C-CELL	2.5v	Each 92.14
0121155001	E15	STANDARD	5	SCREW	C-CELL	2.5v	Each 76.12
0121361001	E36	XENON	6	CLICK-ON	C-CELL	2.5v	Each 114.58
0125361101	E36	XENON	6	CLICK-ON	MEDCHARGE 4000	3.5v	Each 166.66



EUROLIGHT® E10



EUROLIGHT® E30



EUROLIGHT® E15



EUROLIGHT® E36

Ophthalmoscope Heads

Ophthalmoscope							
Cat No	Head	Illumination	Aperture	Connection	Voltage	Pack	Price
0181100001	E10	STANDARD	1	SCREW	2.5v	Each	52.08
0181300001	E30	STANDARD	1	CLICK-ON	2.5v	Each	60.49
0181155001	E15	STANDARD	5	SCREW	2.5v	Each	53.68
0181361001	E36	XENON	6	CLICK-ON	2.5v	Each	88.14
0185361001	E36	XENON	6	CLICK-ON	3.5v	Each	95.35

KaWe PICCOLIGHT® Ophthalmoscopes

The coat pocket ophthalmoscope. Small, easy and yet exact – this is the KaWe PICCOLIGHT®. A high-capacity xenon/halogen/vacuum lamp ensures the excellent illumination of the eye fundus. Its elegant design and the classy colours make the KaWe PICCOLIGHT® a medical instrument that is a pleasure to use day in and day out.



Ophthalmoscopes with Handle & Cloth Bag

Ophthalmoscope									
Cat No	Head	Illumination	Aperture	Colour	Connection	Handle Type	Voltage	Pack	Price
0123500021	E50	STANDARD	1	BLACK	SCREW	AA-CELL	2.5v	Each	68.10
0123500231	E50	STANDARD	1	BLUE	SCREW	AA-CELL	2.5v	Each	68.10
0123500261	E50	STANDARD	1	WHITE	SCREW	AA-CELL	2.5v	Each	68.10
0123555021	E55	STANDARD	5	BLACK	SCREW	AA-CELL	2.5v	Each	71.31
0123555231	E55	STANDARD	5	BLUE	SCREW	AA-CELL	2.5v	Each	71.31
0123555261	E55	STANDARD	5	WHITE	SCREW	AA-CELL	2.5v	Each	71.31
0123561021	E56	XENON	6	BLACK	SCREW	AA-CELL	2.5v	Each	84.93
0123561231	E56	XENON	6	BLUE	SCREW	AA-CELL	2.5v	Each	84.93
0123561261	E56	XENON	6	WHITE	SCREW	AA-CELL	2.5v	Each	84.93

Ophthalmoscope Heads

Ophthalmoscope									
Cat No	Head	Illumination	Aperture	Colour	Connection	Voltage	Pack	Price	
0183500021	E50	STANDARD	1	BLACK	SCREW	2.5v	Each	54.48	
0183500231	E50	STANDARD	1	BLUE	SCREW	2.5v	Each	54.48	
0183500261	E50	STANDARD	1	WHITE	SCREW	2.5v	Each	54.48	
0183555021	E55	STANDARD	5	BLACK	SCREW	2.5v	Each	61.69	
0183555231	E55	STANDARD	5	BLUE	SCREW	2.5v	Each	61.69	
0183555261	E55	STANDARD	5	WHITE	SCREW	2.5v	Each	61.69	
0183561021	E56	XENON	6	BLACK	SCREW	2.5v	Each	74.51	
0183561231	E56	XENON	6	BLUE	SCREW	2.5v	Each	74.51	
0183561261	E56	XENON	6	WHITE	SCREW	2.5v	Each	74.51	



PICCOLIGHT® E50



PICCOLIGHT® E55



PICCOLIGHT® E56



Section 08 - Ophthalmic / ENT

KaWe Dermatoscopes



Dermoscopes with approx 10x magnification available in two styles: EUROLIGHT® (metal handle with click-on connection) and PICCOLIGHT® (plastic handle with screw-on connection).

Dermatoscope with Handle & Bag

Dermatoscope							
Cat No	Head	Illumination	Connection	Handle Type	Voltage	Pack	Price
0131130001	D30	XENON	CLICK-ON	C-CELL	2.5v	Each	200.31
0133100021	D	STANDARD	SCREW	AA-CELL	2.5v	Each	137.01



EUROLIGHT® D30



PICCOLIGHT® D

Dermatoscope Heads

Dermatoscope							
Cat No	Head	Illumination	Connection	Voltage	Pack	Price	
0191130002	D30	XENON	CLICK-ON	2.5v	Each	172.26	
0193100022	D	STANDARD	SCREW	2.5v	Each	128.20	

Dermatoscope Accessories

Cat No		Pack	Price
0199020002	DERMA-GEL 250ml	5	20.05
0199010001	CONTACT DISK 25mm WITH SCALE	Each	24.84



KaWe Handles & Chargers



0174110002

0174110052

0174130002

0174130052

0174130062

0174200021

0174200231

0174200261

Handles for EUROLIGHT / COMBILIGHT

Cat No	For Use With	Colour	Connection	Handle Type	Voltage	Pack	Price
0174110002	EUROLIGHT C & E	SILVER	SCREW	AA-CELL	2.5v	Each	30.45
0174110052	EUROLIGHT C & E	SILVER	SCREW	MEDCHARGE 4000	2.5v	Each	57.69
0174130002	EUROLIGHT C30, FO, E, D & COMBILIGHT FO	SILVER	SCREW	AA-CELL	2.5v	Each	38.46
0174130052	EUROLIGHT C30, FO, E, D & COMBILIGHT FO	SILVER	SCREW	MEDCHARGE 4000	2.5v	Each	64.60
0174131062	EUROLIGHT FO, E & COMBILIGHT FO	SILVER	SCREW	MEDCHARGE 4000	3.5v	Each	68.10

Handles for PICCOLIGHT

Cat No	For Use With	Colour	Connection	Handle Type	Voltage	Pack	Price
0174200021	PICCOLIGHT	BLACK	SCREW	AA-CELL	2.5v	Each	22.03
0174200231	PICCOLIGHT	BLUE	SCREW	AA-CELL	2.5v	Each	22.03
0174200261	PICCOLIGHT	WHITE	SCREW	AA-CELL	2.5v	Each	22.03

MedCharge 4000 Charging Station & Rechargeable Batteries

Cat No	Battery Type	Voltage	Pack	Price
1280005002	MEDCHARGE 4000 CHARGING STATION		Each	116.98
1280110712	REPLACEMENT RECHARGEABLE BATTERY	AA-CELL	2.5v	Each 27.24
1280120712	REPLACEMENT RECHARGEABLE BATTERY	AA-CELL	3.5v	Each 30.45
1280110722	REPLACEMENT RECHARGEABLE BATTERY	C-CELL	2.5v	Each 35.65
1280220722	REPLACEMENT RECHARGEABLE BATTERY	C-CELL	3.5v	Each 29.65



MedCharge 4000



1280110712



1280120712

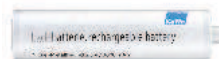

1280110722



1280220722



KaWe Combined Diagnostic Sets

Listed below are a selection of basic combined otoscope and ophthalmoscope diagnostic sets. We also offer sets with additional items including curved lamp supports, tongue blade holders, laryngeal mirrors and nasal speculum. Please call our customer care team on 01707 385226 for details.

Combined Sets with EUROLIGHT Otoscope and EUROLIGHT Ophthalmoscope

Cat No	Otoscope Head	Ophthalmoscope			Voltage	Case Style	Pack	Price
		Head	Connection	Handle Type				
0211002001	C10	E10	SCREW	C-CELL	2.5v	ZIPPER CASE	Each	89.74
0213004001	F.O. 30	E36	SCREW	C-CELL	2.5v	HARD-TOP BOX	Each	193.05
0215004002	F.O. 30 LED	E36	SCREW	C-CELL	2.5v	HARD-TOP BOX	Each	209.92
0218004002	F.O. 30 LED HIGH POWER	E36	SCREW	MEDCHARGE 4000	3.5v	HARD-TOP BOX	Each	233.96



Combined Sets with COMBLIGHT Otoscope and EUROLIGHT Ophthalmoscope

Cat No	Otoscope Head	Ophthalmoscope			Voltage	Case Style	Pack	Price
		Head	Connection	Handle Type				
0223001001	F.O. 30	E30	SCREW	C-CELL	2.5v	ZIPPER CASE	Each	144.22
0223004001	F.O. 30	E36	SCREW	C-CELL	2.5v	HARD-TOP BOX	Each	168.26
0224004102	F.O. 30	E36	SCREW	MEDCHARGE 4000	3.5v	HARD-TOP BOX	Each	208.32
0225004002	F.O. 30 LED	E36	SCREW	C-CELL	2.5v	HARD-TOP BOX	Each	166.76
0228004002	F.O. 30 LED HIGH POWER	E36	SCREW	MEDCHARGE 4000	3.5v	HARD-TOP BOX	Each	166.76

Combined Sets with PICCOLIGHT Otoscope and PICCOLIGHT Ophthalmoscope

Cat No	Otoscope Head	Ophthalmoscope			Voltage	Case Style	Pack	Price	
		Head	Colour	Connection					
0231001021	C	E50	BLACK	SCREW	AA-CELL	2.5v	CLOTH BAG	Each	90.54
0231001232	C	E50	BLUE	SCREW	AA-CELL	2.5v	CLOTH BAG	Each	90.54
0231001262	C	E50	WHITE	SCREW	AA-CELL	2.5v	CLOTH BAG	Each	90.54
0231008022	C	E55	BLACK	SCREW	AA-CELL	2.5v	HARD-TOP BOX	Each	92.94
0231008232	C	E55	BLUE	SCREW	AA-CELL	2.5v	HARD-TOP BOX	Each	92.94
0231008262	C	E55	WHITE	SCREW	AA-CELL	2.5v	HARD-TOP BOX	Each	92.94
0233001021	F.O	E50	BLACK	SCREW	AA-CELL	2.5v	CLOTH BAG	Each	104.96
0233001232	F.O	E50	BLUE	SCREW	AA-CELL	2.5v	CLOTH BAG	Each	104.96
0233001262	F.O	E50	WHITE	SCREW	AA-CELL	2.5v	CLOTH BAG	Each	104.96
0233008022	F.O	E55	BLACK	SCREW	AA-CELL	2.5v	HARD-TOP BOX	Each	108.17
0233008232	F.O	E55	BLUE	SCREW	AA-CELL	2.5v	HARD-TOP BOX	Each	108.17
0233008262	F.O	E55	WHITE	SCREW	AA-CELL	2.5v	HARD-TOP BOX	Each	108.17
0233404022	F.O	E56	BLACK	SCREW	AA-CELL	2.5v	HARD-TOP BOX	Each	133.00
0233404232	F.O	E56	BLUE	SCREW	AA-CELL	2.5v	HARD-TOP BOX	Each	133.00
0233404262	F.O	E56	WHITE	SCREW	AA-CELL	2.5v	HARD-TOP BOX	Each	133.00
0235404022	F.O. LED	E56	BLACK	SCREW	AA-CELL	2.5v	HARD-TOP BOX	Each	138.61
0235404232	F.O. LED	E56	BLUE	SCREW	AA-CELL	2.5v	HARD-TOP BOX	Each	138.61
0235404262	F.O. LED	E56	WHITE	SCREW	AA-CELL	2.5v	HARD-TOP BOX	Each	138.61



KaWe MedCenter® 5000 Wall-Mounted Diagnostic Sets



Wall-mounted stations are used in many medical practices and clinics worldwide.

They offer a space-saving organizational solution as well as serve as a charging station for valuable instruments, keeping them easy to reach, charged and ready for use 24 hours a day.

The KaWe MedCenter® 5000 wall-mounted station for ENT instruments combines high quality electronics with modern design and provides each user with numerous options for the configuration of their individual sets. With the wall station's module system (which consists of basic and accessory modules), holders for different types of instruments can be combined as needed. Assembly is easy. All of the instruments have ergonomic handles with unique dimmable light switches, the user-friendly "soft-touch-system" (KaWe STS®). With this STS technology, soft push buttons are used to adjust the light intensity as needed. The last used light intensity setting is saved even after the handle is removed (memorized light function). The instruments also have a theft-deterrent system to guard against unauthorized use.

Cat No	No of		Voltage	Illumination	Pack	Price
	Handles	Ophthalmoscope Head				
0285030002	2	EUROLIGHT E25	PICCOLIGHT	3.5v	F.O. LED	Each 584.90
0285010002	2	PICCOLIGHT E55	PICCOLIGHT C	3.5v	STANDARD	Each 324.50
0285021002	2	PICCOLIGHT E56	PICCOLIGHT	3.5v	F.O. LED	Each 373.37

KaWe MedCenter® 5000 Wall-Mounted Diagnostic Modules

KaWe wall-mounted diagnostic set modules and handles (without heads).

Cat No		Pack	Price
0281000002	MEDCENTER 5000 WALL MODULE WITH ONE HANDLE	Each	175.47
0281001002	MEDCENTER 5000 WALL MODULE WITH TWO HANDLES	Each	245.98
0284000002	MEDCENTER 5000 ADDON MODULE WITH ONE HANDLE	Each	102.56
0284001002	EAR FUNNEL MODULE	Each	23.84



Section 08 - Ophthalmic / ENT

KaWe Binocular Magnifying Glasses

The ability to observe images of accurately reproduced structures with both eyes and perform precise work with both hands – magnifying eyeglasses offer all these features. Increasing demands on precision and quality as well as new surgical technologies make magnifying eyeglasses an indispensable aid in the field of medicine. They are to be used in the dental, dermatological, otholaryngological, ophthalmological fields and in general medicine, in neurosurgery, during microsurgical operations, in veterinary medicine and also during other types of medical examinations.

KaWe magnifying eyeglasses ensure precise vision and an individually adjustable ergonomic operating position. These user-friendly designs are available as binocular magnifying glasses (BC 2.3), safety glasses with classical spectacle frames (BS 2.3) and with a headband (BK 2.3). Coated optical components and the rough structure of the optical tube reduce diffused light to an indiscernible level (less than 1%). All models are equipped with a finely adjustable duplex joint with an optimally matched mechanism of CNC milled solid material. The technology of KaWe magnifying eyeglasses is based on state-of-the-art BiTech optics that makes achromatic lenses dispensable. This technology makes the magnifying eyeglasses lighter and less expensive. It goes without saying that all KaWe models ensure a perfect fit, stay securely in place and have optics that are both dust and splash proof. The BK 2.3 headband magnifying glasses can be used by spectacle wearers and non-spectacle wearers alike.



The BC 2.3 Binocular Magnifying Glasses are the classic model of KaWe Binoculars. The metal eyeglass frames fit perfectly thanks to spring hinges and exceed all expectations due to their simple but precise mechanical design. The length of the anti-slip frames can be freely adjusted within the range of 125 to 150mm.

- With HRI ocular
- The oculars can be individually adjusted to fit any pupillary distance (PD)
- Optics with 2.3 times magnification
- The optics are dustproof and splash-proof
- The state-of-the-art BiTech optics makes achromatic lenses unnecessary. This technology makes the magnifying eyeglasses lighter and less expensive
- Coated optical components and the rough structure of the optical tube (MT9019, REF 33, VDI3400) reduce diffused light to an indiscernible level (less than 1%).
- The preadjusted angle of vision enables an operating distance of 340 mm and a field of vision of 110 mm



Due to their especially lightweight metal construction (the frames only weigh 66 g), the stylish BS 2.3 binocular magnifying glasses with safety glasses are very comfortable to wear and can be adjusted to fit every face shape. An especially practical feature is the large, ergonomic safety glasses lenses, which can be refitted by an optician to fit the user's correctional lens prescription.

- These oculars can be adjusted thanks to the finely-adjustable duplex joint and optimally-matched mechanics made of cnc-cut solid material. The tilt angle can be set easily and securely. This enables the wearer to assume a comfortable and fatigue-free work posture.



The KaWe Headband Binocular BK 2.3 Magnifying Glasses ensure a perfect fit because of their comfortable, continuously adjustable headband. The binocular magnifying glasses can be used by spectacle wearers as well as by non-spectacle wearers.

- These oculars can be adjusted thanks to the finely-adjustable duplex joint and optimally-matched mechanics made of cnc-cut solid material. The tilt angle can be set easily and securely. This enables the wearer to assume comfortable and fatigue-free work posture.



The KaWe safety glasses have been especially developed for medical purposes. If used in the dental, dermatological, surgical and veterinary medicine or in the laboratory, these safety glasses are indispensable when handling dust, fine matter such as shavings and splinters, chemical substances or biological agents as well as during optical radiation or in order to avoid eye irritation due to high or low temperatures. These KaWe safety glasses are very comfortable to wear due to their anti-slip ear pieces, individually-adjustable silicone pads and stylish design. The frames of these glasses are versatile: they can be used as magnifying eyeglasses with a binocular magnifying glass attachment, as correctional glasses or as sunglasses. (An optician can fit the frames with suitable lenses.)

- Trendy design, for ladies and gentlemen (unisex) adjustable (base 6)
- The frames of the glasses are made of extremely light, specially-alloyed nickel silver
- Large, ergonomic splash guard surface
- Excellent wearing comfort because of anti-slip earpieces and individually adjustable silicone pads
- Earpiece length 125 mm

Cat No		Pack	Price
1310321302	BINOCULAR MAGNIFYING GLASSES WITH EYEGLASS FRAMES BC2.3	Each	159.44
1310521301	BINOCULAR MAGNIFYING GLASSES WITH HEADBAND BK2.3	Each	197.95
1315121301	BINOCULAR MAGNIFYING GLASSES WITH SAFETY GLASSES BS2.3	Each	280.43
1305110002	SAFETY GLASSES	Each	88.14
1325971002	SPECTACLES CASE FOR BC2.3 AND SAFETY GLASSES	Each	8.81
1325972002	SPECTACLES CASE FOR BS2.3	Each	8.81
1325983001	CARRY CASE FOR BK2.3	Each	16.83
1325931002	SECURING STRAP FOR BS2.3	Each	16.83
1325901001	CLEANING SPRAY 25ml	Each	5.21
1325905001	MICROFIBRE CLOTH	Each	2.80



KaWe Diagnostic Penlights



- Made of metal, painted
- With clip contact
- Smooth surface
- Includes replaceable batteries: 1.5v (type AAA)
- Practically packaged in blister pack



- Made of metal
- With push button
- Includes replaceable batteries: 1.5v (type AAA)

Cat No		Pack	Price
1205201024	PENLIGHT BLACK	6	28.86
1205201014	PENLIGHT RED	6	28.86
1205201054	PENLIGHT YELLOW	6	28.86
1205201234	PENLIGHT BLUE	6	28.86
1205201264	PENLIGHT GREY	6	28.86
1205201094	PENLIGHT VIOLET	6	28.86
1205211004	PENLIGHT ASSORTED	6	28.86

Cat No		Pack	Price
1205100071	PENLIGHT WHITE	Each	3.69



- With xenon bulb 2.5v
- Plastic head
- Cloth bag
- Batteries 1.5v, mignon (type AA)
- Length approx 13 cm
- Diameter approx 2 cm

Cat No		Pack	Price
1205302021	DIALIGHT BLACK	Each	24.04
1205302231	DIALIGHT BLUE	Each	24.04
0178401021	CLOTH BAG	Each	7.21

KaWe Replacement Bulbs

1275111013	1275112003	1275113003	1275114003	1275121003	1275122013	1275123013
1275126003	1275127003	1275141003	1275142013	1275144013	1275145003	1275132003
1275151003	1275241003	1275154003	1275242013	1275152003	1275244013	1275251003
1275232003	1275253003	1275234003	1275254003	1275234003	1275254003	1275234003
1275254003	1275254003	1275254003	1275254003	1275254003	1275254003	1275254003

Cat No	For use with	Type	Voltage	Pack	Price
1275111013	EUROLIGHT C, COMBILIGHT C & PICCOLIGHT C	VACUUM	2.5v	Each	5.13
1275112003	EUROLIGHT E30, PICCOLIGHT E50, E55 & D	VACUUM	2.5v	Each	12.66
1275113003	EUROLIGHT E15 & E16	VACUUM	2.5v	Each	14.26
1275114003	EUROLIGHT E10	VACUUM	2.5v	Each	3.61
1275121003	COMPATIBLE 0.35	KRYPTON	2.5v	Each	7.69
1275122013	COMPATIBLE 0.37	KRYPTON	2.5v	Each	6.45
1275123013	COMPATIBLE 0.41	KRYPTON	2.5v	Each	9.21
1275126003	REUSABLE LARYNGOSCOPE BLADES 00 - 1	VACUUM	2.5v	Each	4.97
1275127003	REUSABLE LARYNGOSCOPE BLADES 2 - 5	VACUUM	2.5v	Each	4.97
1275141003	FIBRE-OPTIC LARYNGOSCOPE HANDLES	XENON	2.5v	Each	10.90
1275142013	COMPATIBLE 0.35	XENON	2.5v	Each	12.02
1275144013	FIBRE-OPTIC XL OTOSCOPES	XENON	2.5v	Each	10.58
1275145003	DIALIGHT	XENON	2.5v	Each	10.82
1275132003	EUROLIGHT E36, D30, PICCOLIGHT E56	XENON	2.5v	Each	21.23
1275151003	LARYNGOSCOPE HANDLES F.O. HIGH POWER	LED	2.5v	Each	38.46
1275154003	LARYNGOSCOPE HANDLES F.O. STANDARD	LED	2.5v	Each	16.02
1275152003	PICCOLIGHT F.O. LED HIGH POWER OTOSCOPE	LED	2.5v	Each	38.46
1275153003	EUROLIGHT C30 OP LED, F.O.30 LED, COMBILIGHT F.O. LED & PICCOLIGHT F.O. LED STANDARD OTOSCOPE	LED	2.5v	Each	16.02
1275232003	EUROLIGHT E36, D30, PICCOLIGHT E55 & E56	XENON	3.5v	Each	22.84
1275234003	EUROLIGHT E25	XENON	3.5v	Each	27.64
1275241003	FIBRE-OPTIC XL OTOSCOPES	XENON	3.5v	Each	14.02
1275242013	COMPATIBLE 0.44	XENON	3.5v	Each	15.86
1275244013	FIBRE-OPTIC LARYNGOSCOPE HANDLES	XENON	3.5v	Each	15.06
1275251003	LARYNGOSCOPE HANDLES F.O. HIGH POWER	LED	3.5v	Each	42.47
1275253003	EUROLIGHT F.O.30 LED, COMBILIGHT F.O.30 LED	LED	3.5v	Each	42.47
1275254003	EUROLIGHT D30	LED	3.5v	Each	16.83

Section 08 - Ophthalmic / ENT

KaWe Fibre-Optic Laryngoscopes

In the mouth and throat, lighting conditions are very poor. In order to accommodate for these conditions, KaWe has created a safe and easy intubation method using advanced light technology (LED – with up to 70% more light) and the latest F.O. light guides. All KaWe fibre-optic laryngoscopes have a powerful LED light (2.5v or 3.5v) in their handles. The tried and tested xenon light is still available as well. You can, by the way, update the xenon lamp in your handle simply by replacing it with an LED lamp (no other components are required). An extensive selection of F.O. blades from the fibre optic line (Macintosh, Miller, Foregger, KaWe FLAPLIGHT®, TEPRO®, KaWe MEGALIGHT®, Economy, Polio) makes it possible to meet the needs of even very difficult anatomic conditions. Macintosh blades are available with integrated as well as with exchangeable fibre optics. KaWe technicians place a particular importance on easy handling and guarantee that the blades can be exchanged quickly. All blade types are made of stainless steel, are compatible and the reusable blades can be sterilized in an autoclave at 134°C.

Reusable Blades

MEGALIGHT® Macintosh F.O.



- Matte stainless steel – prevents back reflection
- With integrated fibre optics
- No dirt-collecting recesses (easy to clean)
- Very large fibre optics – cross section (3.0 x 7.0 mm) 8000 single fibres minimum for optimal light emission
- Brightness >6,000 lux at 2.5v, >13,000 lux at 3.5v (measured at a distance of 35mm from the light emission source)
- Can be autoclaved at up to 134°C approx 4000 times
- Compliant with DIN ISO 7376 standards
- Maintenance-free



Cat No	Size	Pack	Price
0342244601	0	Each	68.10
0342244611	1	Each	68.10
0342244621	2	Each	68.10
0342244631	3	Each	68.10
0342244641	4	Each	68.10

Macintosh F.O.



- Matte stainless steel – prevents back reflection
- Replaceable light guide
- Easy to clean
- Environmentally friendly and cost-effective
- Fibre-optic illumination Ø 4mm, 5500 single fibres minimum
- Brightness >4,200 lux at 2.5v, >12,500 lux at 3.5v (measured at a distance of 35mm from the light emission source)
- Can be autoclaved at up to 134°C approx 4000 times
- Compliant with DIN ISO 7376 standards



Cat No	Size	Pack	Price
0342013601	0	Each	49.68
0342013611	1	Each	49.68
0342013621	2	Each	49.68
0342013631	3	Each	49.68
0342013641	4	Each	49.68
0342013651	5	Each	49.68

TEPRO® Macintosh F.O.



- Tapered blade end near the handle for easy intubation, even for difficult anatomic conditions
- Matte stainless steel – prevents back reflection
- Replaceable light guide
- Easy to clean
- Environmentally friendly and cost-effective
- Fibre-optic illumination Ø 4mm, 5500 single fibres minimum
- Brightness >4,200 lux at 2.5v, >12,500 lux at 3.5v (measured at a distance of 35mm from the light emission source)
- Can be autoclaved at up to 134°C approx 4000 times
- Compliant with DIN ISO 7376 standards



Cat No	Size	Pack	Price
0342073621	2	Each	64.10
0342073631	3	Each	64.10
0342073641	4	Each	64.10

FLAPLIGHT® F.O.



- The movable blade tip facilitates lifting of the epiglottis and enables good visibility of the intubation process even if the anatomic conditions are difficult. Improved visibility and less lever action reduce the risk of injury to the larynx and teeth. The fibre optic illumination cannot be replaced by the customers themselves. The blades must therefore be sent in to KaWe.
- Can be bent up to 60°
- For further characteristics please refer to the Macintosh F.O.



Cat No	Size	Pack	Price
0342053621	2	Each	191.49
0342053631	3	Each	191.49
0342053641	4	Each	191.49

FLAPLIGHT® F.O. MEGALIGHT®



- Same characteristics as FLAPLIGHT® F.O. but the fibre-optics cannot be exchanged
- For further characteristics please refer to the MEGALIGHT® Macintosh F.O.



Cat No	Size	Pack	Price
0342254621	2	Each	200.31
0342254631	3	Each	200.31
0342254641	4	Each	200.31



KaWe Fibre-Optic Laryngoscopes

Reusable Blades - Continued

MEGALIGHT® Miller F.O.



- Matte stainless steel – prevents back reflection
- With integrated fibre optics
- No dirt-collecting recesses (easy to clean)
- Fibre optics diameter 3.0mm
- Brightness >6,000 lux at 2.5v, >13,000 lux at 3.5v (measured at a distance of 35mm from the light emission source)
- Can be autoclaved at up to 134°C approx 4000 times
- Compliant with DIN ISO 7376 standards
- Maintenance-free



Cat No	Size	Pack	Price
0342246591	00	Each	68.10
0342246601	0	Each	68.10
0342246611	1	Each	68.10
0342246621	2	Each	68.10
0342246631	3	Each	68.10
0342246641	4	Each	68.10

Miller F.O.



- Matte stainless steel – prevents back reflection
- Replaceable light guide
- Easy to clean
- Environmentally friendly and cost-effective
- Fibre-optic illumination Ø 4mm, 5500 single fibres minimum
- Brightness >4,200 lux at 2.5v, >12,500 lux at 3.5v (measured at a distance of 35mm from the light emission source)
- Can be autoclaved at up to 134°C approx 4000 times
- Compliant with DIN ISO 7376 standards



Cat No	Size	Pack	Price
0342023591	00	Each	68.10
0342023601	0	Each	68.10
0342023611	1	Each	68.10
0342023621	2	Each	68.10
0342023631	3	Each	68.10
0342023641	4	Each	68.10

Foregger F.O.



- Matte stainless steel – prevents back reflection
- Replaceable light guide
- Easy to clean
- Environmentally friendly and cost-effective
- Fibre-optic illumination Ø 4mm, 5500 single fibres minimum
- Brightness >4,200 lux at 2.5v, >12,500 lux at 3.5v (measured at a distance of 35mm from the light emission source)
- Can be autoclaved at up to 134°C approx 4000 times
- Compliant with DIN ISO 7376 standards



Cat No	Size	Pack	Price
0342033601	0	Each	68.10
0342033611	1	Each	68.10
0342033621	2	Each	68.10
0342033631	3	Each	68.10
0342033641	4	Each	68.10

Polio Macintosh F.O.



- Improved easy use on obese patients
- Replaceable light guide
- Easy to clean



Cat No	Size	Pack	Price
0342063631	3	Each	63.30
0342063641	4	Each	63.30

Economy Macintosh F.O.



- Stainless steel design with unbreakable plastic socket, same service life as metal model
- The light guide is not replaceable
- Fibre-optics Ø 3.0mm, 3000 single fibres minimum
- Brightness >3,500 lux at 2.5v, >10,000 lux at 3.5v
- Environmentally friendly, economical and cost-effective
- Can be autoclaved at up to 134°C approx 4000 times
- Compliant with DIN ISO 7376 standards
- Maintenance free



Cat No	Size	Pack	Price
0342011601	0	Each	34.45
0342011611	1	Each	34.45
0342011621	2	Each	34.45
0342011631	3	Each	34.45
0342011641	4	Each	34.45
0342011651	5	Each	34.45

Economy Miller F.O.



- Stainless steel design with unbreakable plastic socket, same service life as metal model
- The light guide is not replaceable
- Fibre-optics Ø 3.0mm, 3000 single fibres minimum
- Brightness >3,500 lux at 2.5v, >10,000 lux at 3.5v
- Environmentally friendly, economical and cost-effective
- Can be autoclaved at up to 134°C approx 4000 times
- Compliant with DIN ISO 7376 standards
- Maintenance free



Cat No	Size	Pack	Price
0342021591	00	Each	34.45
0342021601	0	Each	34.45
0342021611	1	Each	34.45
0342021621	2	Each	34.45
0342021631	3	Each	34.45
0342021641	4	Each	34.45

Section 08 - Ophthalmic / ENT

KaWe Fibre-Optic Laryngoscopes

Disposable Blades

Macintosh F.O.



- Matte stainless steel – prevents back reflection
- With fine-polished acrylic fibre optics with excellent light transmission
- Illumination at the blade tip >10,000 lux at 2.5v, with LED-handle >16,000 lux at 3.5v
- Very safe, cross-infection is avoided
- Locks firmly into place with two ball fasteners
- Lightweight
- Compliant with DIN ISO 7376 standards
- Packaged in practical tyvek packaging



Cat No	Size	Pack	Price
0344014602	0	10	36.10
0344014612	1	10	36.10
0344014622	2	10	36.10
0344014632	3	10	36.10
0344014642	4	10	36.10

Miller F.O.



- Matte stainless steel – prevents back reflection
- With fine-polished acrylic fibre optics with excellent light transmission
- Illumination at the blade tip >10,000 lux at 2.5v, with LED-handle >16,000 lux at 3.5v
- Very safe, cross-infection is avoided
- Locks firmly into place with two ball fasteners
- Lightweight
- Compliant with DIN ISO 7376 standards
- Packaged in practical tyvek packaging



Cat No	Size	Pack	Price
0344024592	00	10	36.10
0344024602	0	10	36.10
0344024612	1	10	36.10
0344024622	2	10	36.10
0344024632	3	10	36.10
0344024642	4	10	36.10

Macintosh F.O. Plastic

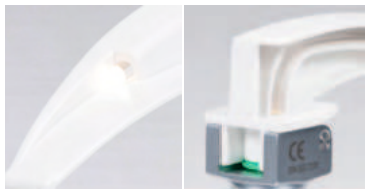

- Acrylic light guide (PMMA) ensures optimal light transmission
- Brightness >18,700 lux at 3.5v
- Light guide diameter 3.8 mm
- No spreading of infection
- Environmentally-friendly / recyclable plastic (polyamide)
- Maintenance free
- Packaged sterile



Cat No	Size	Pack	Price
0343114622	2	10	32.00
0343114632	3	10	32.00
0343114642	4	10	32.00

Miller F.O. Plastic

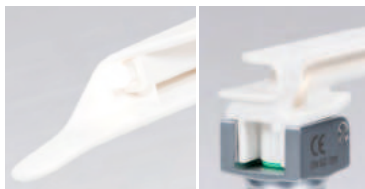

- Acrylic light guide (PMMA) ensures optimal light transmission
- Brightness >18,700 lux at 3.5v
- Light guide diameter 3.8 mm
- No spreading of infection
- Environmentally-friendly / recyclable plastic (polyamide)
- Maintenance free
- Packaged sterile



Cat No	Size	Pack	Price
0343124602	0	10	32.00
0343124612	1	10	32.00
0343124622	2	10	32.00
0343124632	3	10	32.00

F.O. Handles

Reusable Handles

Cat No	Size	Type	Illumination	Voltage	Pack	Price
0341000711	SMALL	AA-CELL	XENON	2.5v	Each	47.27
0341000721	MEDIUM	C-CELL	XENON	2.5v	Each	48.07
0341000731	LARGE	C-CELL	XENON	2.5v	Each	49.68
0341100741	SHORT	AA-CELL	XENON	2.5v	Each	49.68
0341001721	MEDIUM ECONOMY	C-CELL	XENON	2.5v	Each	39.26
0341100711	SMALL	MEDCHARGE 4000	XENON	2.5v	Each	72.11
0341100721	MEDIUM	MEDCHARGE 4000	XENON	2.5v	Each	82.53
0341010711	SMALL	MEDCHARGE 4000	XENON	3.5v	Each	124.19
0341010521	MEDIUM	MEDCHARGE 4000	XENON	3.5v	Each	90.54
0341020711	SMALL	AA-CELL	LED	2.5v	Each	56.89
0341020721	MEDIUM	C-CELL	LED	2.5v	Each	56.09
0341030711	SMALL	AA-CELL	LED HIGH POWER	2.5v	Each	87.33
0341030721	MEDIUM	C-CELL	LED HIGH POWER	2.5v	Each	88.14
0341140711	SMALL	MEDCHARGE 4000	LED HIGH POWER	3.5v	Each	142.62
0341140521	MEDIUM	MEDCHARGE 4000	LED HIGH POWER	3.5v	Each	148.23

Disposable Handles

Cat No	Size	Type	Illumination	Voltage	Pack	Price
0341022721	MEDIUM	C-CELL	LED	2.5v	Each	8.59



All KaWe conventional laryngoscope blades and handles can be supplied in cased sets. Please call our customer care team on 01707 385226 for details.



KaWe Conventional Laryngoscopes

Conventional warm light laryngoscopes have been a part of the reputed KaWe assortment for many years. This high-performance quality instrument has proven itself in its every day use as an extremely reliable and durable instrument. Our warm light handles can be used with our warm light blades (Macintosh, Miller, Foregger, Polio). As with the F.O. models, these instruments are easy to use and the blades are easy to change. We also offer a KaWe FLAPLIGHT® C model in our line of warm light laryngoscopes, which we have expanded to include single-use blades made of metal. These come as either Macintosh or Miller models and have LED lamps. All blade types are made of stainless steel, are compatible and the reusable blades can be sterilized as described in the user's manual.

Reusable Blades

Macintosh C



- Stainless steel, matte finish, prevents reflection
- Vacuum bulb
- Brightness >1500 and/or >2000 lux at 2.5v depending on lamp/blade size
- Can be sterilized as instructed in the user's manual
- Compatible according to DIN ISO 7376



Cat No	Size	Pack	Price
0312010602	0	Each	23.96
0312010612	1	Each	23.96
0312010622	2	Each	23.96
0312010632	3	Each	23.96
0312010642	4	Each	23.96
0312010652	5	Each	23.96

Miller C



- Stainless steel, matte finish, prevents reflection
- Vacuum bulb
- Brightness >1500 and/or >2000 lux at 2.5v depending on lamp/blade size
- Can be sterilized as instructed in the user's manual
- Compatible according to DIN ISO 7376



Cat No	Size	Pack	Price
0312020592	00	Each	23.96
0312020602	0	Each	23.96
0312020612	1	Each	23.96
0312020622	2	Each	23.96
0312020632	3	Each	23.96
0312020642	4	Each	23.96

Foregger C



- Stainless steel, matte finish, prevents reflection
- Vacuum bulb
- Brightness >1500 and/or >2000 lux at 2.5v depending on lamp/blade size
- Can be sterilized as instructed in the user's manual
- Compatible according to DIN ISO 7376



Cat No	Size	Pack	Price
0312030602	0	Each	23.96
0312030612	1	Each	23.96
0312030622	2	Each	23.96
0312030632	3	Each	23.96
0312030642	4	Each	23.96

FLAPLIGHT® C



- The flexible and up to 60° bendable blade tip makes it easier to raise the epiglottis and makes it possible to insert the instrument with a good line of sight even under the most difficult anatomical conditions. Better vision and less leverage effect reduce the risk of injury to the larynx and teeth. The bulbs can be exchanged effortlessly and individually.



Cat No	Size	Pack	Price
0312050622	2	Each	117.78
0312050632	3	Each	117.78
0312050642	4	Each	117.78

Polio Macintosh C



- Improved easy use on obese patients
- Easy to clean
- For further characteristics please refer to the Macintosh C



Cat No	Size	Pack	Price
0312060632	3	Each	32.85
0312060642	4	Each	32.85

Section 08 - Ophthalmic / ENT

KaWe Conventional Laryngoscopes

Reusable Blades - Continued

Economy Macintosh C



- Stainless steel, matte finish with non-breakable plastic socket, same product lifetime as metal
- Vacuum bulb
- Brightness >1500 and/or >2000 lux at 2.5v depending on lamp/blade size
- Environmentally-friendly, economical and inexpensive
- Can be sterilized as instructed in the user's manual
- Compatible according to DIN ISO 7376



Cat No	Size	Pack	Price
0312011602	0	Each	13.54
0312011612	1	Each	13.54
0312011622	2	Each	13.54
0312011632	3	Each	13.54
0312011642	4	Each	13.54
0312011652	5	Each	13.54

Economy Miller C



- Stainless steel, matte finish with non-breakable plastic socket, same product lifetime as metal
- Vacuum bulb
- Brightness >1500 and/or >2000 lux at 2.5v depending on lamp/blade size
- Environmentally-friendly, economical and inexpensive
- Can be sterilized as instructed in the user's manual
- Compatible according to DIN ISO 7376



Cat No	Size	Pack	Price
0312021592	00	Each	13.54
0312021602	0	Each	13.54
0312021612	1	Each	13.54
0312021622	2	Each	13.54
0312021632	3	Each	13.54
0312021642	4	Each	13.54

Disposable Blades

Macintosh C



- Stainless steel, matte finish – prevents reflection
- Suitable for use in emergency medicine
- Powerful LED with white, uniform illumination
- Illumination at the blade tip: >6,000 Lux at 2.5v
- Light guide diameter 5mm
- Very safe, cross-contamination is prevented
- Held securely in place with two ball anchors
- Lightweight
- Compatible according to DIN ISO 7376
- Cannot be used with the 2.5v rechargeable battery
- In practical tyvek packaging



Cat No	Size	Pack	Price
0314010602	0	10	39.70
0314010612	1	10	39.70
0314010622	2	10	39.70
0314010632	3	10	39.70
0314010642	4	10	39.70

Miller C



- Stainless steel, matte finish – prevents reflection
- Suitable for use in emergency medicine
- Powerful LED with white, uniform illumination
- Illumination at the blade tip: >6,000 Lux at 2.5v
- Light guide diameter 5mm
- Very safe, cross-contamination is prevented
- Held securely in place with two ball anchors
- Lightweight
- Compatible according to DIN ISO 7376
- Cannot be used with the 2.5v rechargeable battery
- In practical tyvek packaging



Cat No	Size	Pack	Price
0314020592	00	10	39.70
0314020602	0	10	39.70
0314020612	1	10	39.70
0314020622	2	10	39.70
0314020632	3	10	39.70
0314020642	4	10	39.70

Conventional Handles

Reusable Handles

Cat No	Size	Type	Voltage	Pack	Price
0311000711	SMALL	AA-CELL	2.5v	Each	22.43
0311000721	MEDIUM	C-CELL	2.5v	Each	24.04
0311000731	LARGE	C-CELL	2.5v	Each	27.24
0311001721	MEDIUM ECONOMY	C-CELL	2.5v	Each	19.23
0311100711	SMALL	MEDCHARGE 4000	2.5v	Each	46.47
0311100721	MEDIUM	MEDCHARGE 4000	2.5v	Each	56.89

Disposable Handles

Cat No	Size	Type	Voltage	Pack	Price
0311002721	MEDIUM	C-CELL	2.5v	Each	6.33

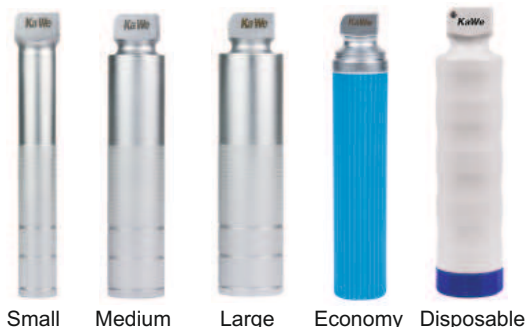

All KaWe conventional laryngoscope blades and handles can be supplied in cased sets. Please call our customer care team on 01707 385226 for details.



KaWe Headlights

Features:

- Ergonomic and modern design with LED technology.
- High-powered LED with white uniform light for all kinds of diagnostic applications such as in dentistry and ENT.
- Coated optics ensure optimal illumination and less heat development.
- Highly-efficient LED, therefore long battery life.
- Aluminum cover on the joints keeps the lamp cool through convection and radiation, eliminating the need for additional cooling with noisy fans.
- Freely adjustable illumination area size, iris shutter, and illumination angle.
- Can be used with binocular magnifying glasses.
- Freely and easily adjustable headband thanks to an integrated levelling system. No troubling screws under hoods.
- Replaceable forehead padding.
- Very lightweight headlamp - approx 160 grams without rechargeable battery, approx 390 grams with rechargeable battery. Optimal comfort is ensured even when used for long periods of time.
- Quick and easy replacement of the rechargeable batteries with the clip/plug system.

Technical data:

LED life	Approx. 50,000 hours
Brightness	Adjustable with 5 settings
Light spot	Adjustable from 60mm to 110mm (at a distance of 250mm), adjustable from 120mm to 240mm (at a distance of 500mm)
Rechargeable battery	Polymer lithium
Charging time of rechargeable battery for headband	Approx. 4.5 hours
Charging time of rechargeable battery for belt	Approx. 6 hours
Rechargeable battery life	>500 charges
Light intensity	>50,000 Lux with a light spot diameter of 45mm (open shutter)
Battery life of rechargeable battery for headband	Approx. 12 hours
Battery life of rechargeable battery for belt	Approx. 24 hours
Voltage (charger)	100v~ - 240v~
Guarantee	24 months from date of purchase
Colour temperature	5,500 K - 6,000 K
Rechargeable battery voltage	8.4v
Power	3 W (LED)
Weight	Approx. 160g without rechargeable battery



Cat No		Pack	Price
1289310122	H-800 SET INCLUDING HEADLIGHT(1) & HEADBAND BATTERY(2)	Each	661.02
1289311222	H-800 SET INCLUDING HEADLIGHT(1), BELT BATTERY(3) & CONNECTOR CABLE(4)	Each	705.08
1289312322	H-800 SET INCLUDING HEADLIGHT(1), HEADBAND BATTERY(2), BELT BATTERY(3) & CONNECTOR CABLE(4)	Each	800.43
1289935002	H-800 HEADLIGHT(1) ONLY	Each	536.82
1289950102	H-800 HEADBAND BATTERY(2) ONLY	Each	160.25
1289950202	H-800 BELT BATTERY(3) ONLY	Each	200.31
1289940001	H-800 CONNECTOR CABLE(4) ONLY	Each	6.41
1289960202	H-800 REPLACEMENT POWER PLUG	Each	15.62



Cat No		Working Distance	Magnification	Pack	Price
1289342342	H-800 BINOCULAR MAGNIFYING GLASSES	340mm	2.5x	Each	191.49
1289343342	H-800 BINOCULAR MAGNIFYING GLASSES	340mm	3.5x	Each	191.49
1289342422	H-800 BINOCULAR MAGNIFYING GLASSES	420mm	2.5x	Each	191.49
1289343422	H-800 BINOCULAR MAGNIFYING GLASSES	420mm	3.5x	Each	191.49

Section 09 - Lighting

KaWe Forehead Mirrors

Our new product line of »Clar« mirrors is characterized by high quality, optimal handling as well as user-friendliness and is excellently suited for routine diagnostic examinations. Whether with battery operation or AC power, KaWe offers you the ability to select according to your individual area of use.



Forehead Mirror with Battery Compartment

- Precise light spot
- 6v vacuum bulb, 3 watts
- Cable length approx 170cm including power plug
- Separately disconnectable battery compartment with power socket for 4 x 1.5v C-cell batteries
- Belt clip



Forehead Mirror with AC power supply

- Precise light spot
- 6v vacuum bulb, 3 watts
- Cable length approx 90cm including power plug
- Only for AC power operation
- AC adaptor with approx 168cm long cable
- On/Off switch
- Interchangeable power plug (EU, GB & US)

Cat No		Diameter	Pack	Price
1289211012	FOREHEAD MIRROR WITH BATTERY COMPARTMENT	55mm	Each	117.78
1289211022	FOREHEAD MIRROR WITH BATTERY COMPARTMENT	100mm	Each	124.19
1289213012	FOREHEAD MIRROR WITH AC POWER SUPPLY	55mm	Each	113.77
1289213022	FOREHEAD MIRROR WITH AC POWER SUPPLY	100mm	Each	116.18
1289915052	REPLACEMENT FOREHEAD MIRROR BULB		Each	4.81

KaWe Examination Lights

KaWe MASTERLIGHT® Classic Examination Lights

- Modern, slim design
- Precise light spot
- Easy to use, infinitely adjustable
- Supply voltage: 230v
- Lamp: 12v/35 Watts, with halogen cold light reflector
- Generates 44000 Lux light output at 40cm
- Reflection angle: 8°
- Colour temperature: approx. 3200° Kelvin
- Easy and quick assembly

KaWe MASTERLIGHT® Classic LED Examination Lights

- Modern, slim design
- Precise light spot
- Easy to use, infinitely adjustable
- Supply voltage: 230v
- Lamp: 12v/10 Watts (80% less energy compared to MASTERLIGHT® Classic)
- Generates 7500 Lux light output at 40cm
- Reflection angle: 24°
- Colour temperature: approx. 3000° Kelvin
- Easy and quick assembly



Cat No		Pack	Price
1011011002	MASTERLIGHT CLASSIC WITH MOBILE STAND	Each	238.77
1011020002	MASTERLIGHT CLASSIC LED WITH MOBILE STAND	Each	284.44
1012011002	MASTERLIGHT CLASSIC WITHOUT STAND	Each	166.66
1012020002	MASTERLIGHT CLASSIC LED WITHOUT STAND	Each	218.74
1090201001	WALL BRACKET FOR MASTERLIGHT	Each	17.63
1090301001	TABLE CLAMP FOR MASTERLIGHT	Each	23.24
1090100002	SPARE 35W BULB FOR MASTERLIGHT CLASSIC	Each	19.23
1090120002	SPARE 10W BULB FOR MASTERLIGHT CLASSIC LED	Each	56.09



Section 10 - Proctological Products

Proctolux® - Self-Illuminating Proctoscope

PROCTOLUX® is a range of single use, fully disposable and self-illuminating Proctoscopes for use in diagnosis and treatment of the anal cavity and rectum.

PROCTOLUX® is supplied in two sizes; 19mm and 25mm. The smaller diameter Proctoscope is used mainly for examination purposes with the larger being used for treatments such as haemorrhoid ligation or injection.

The PROCTOLUX® has a revolutionary designed and patented 'CLEAR VIEW System' which protects the light guide to give a clear and unobstructed view of the examination area.

System features and advantages

- Integrated "LUX System"
- Features revolutionary 'CLEAR VIEW System'
- Available in two sizes 19mm and 25mm
- PROCTOLUX®, including the battery and LED, is simply dropped into the clinical waste bin after use, saving time, money and effort



Cat No		Pack	Price
00335	PROCTOLUX DISPOSABLE PROCTOSCOPE 19mm	25	73.75
00336	PROCTOLUX DISPOSABLE PROCTOSCOPE 25mm	25	73.75

Fogless Proctoscope



Fogless disposable proctoscopes are translucent and are available in large adult, adult and child sizes. They can be provided with or without disposable light source. If purchased without light source, then the FLA1 adaptor allows connection of a Welch Allyn light handle or the E0318101 light adaptor allows attachment of a Heine light handle.

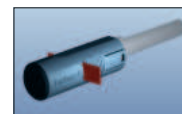

Disposable Light Source

Cat No		Pack	Price	10+
HFP503	FOGLESS DISPOSABLE PROCTOSCOPE 12x40mm - CHILD	10	30.21	29.25
HFP502	FOGLESS DISPOSABLE PROCTOSCOPE 20x70mm - ADULT	10	15.20	14.20
HFP504	FOGLESS DISPOSABLE PROCTOSCOPE 22x70mm - L/ADULT	10	15.75	14.75
503L	FOGLESS DISPOSABLE PROCTOSCOPE WITH DISPOSABLE LIGHT SOURCE 12x40mm - CHILD	25	72.50	
502L	FOGLESS DISPOSABLE PROCTOSCOPE WITH DISPOSABLE LIGHT SOURCE 20x70mm - ADULT	25	72.50	
504L	FOGLESS DISPOSABLE PROCTOSCOPE WITH DISPOSABLE LIGHT SOURCE 22x70mm - L/ADULT	25	72.50	
FLA1	LIGHT ADAPTOR FOR WELCH ALLYN LIGHT HANDLE	Each	64.65	

Section 10 - Proctological Products

Sigmolux® - Self-Illuminating Sigmoidoscope

SIGMOLUX® is a self-contained, single use, fully disposable, cable-less and self-illuminating Rigid Sigmoidoscope system designed to optimise mobility during diagnosis and treatment.

SIGMOLUX® is supplied fully assembled and complete with insufflator for inflating the bowel with a lens to provide a clear view of the observation area.

SIGMOLUX® uses the revolutionary designed and patented 'CLEAR VIEW System' which protects the light guide to give a clear and unobstructed view of the examination area.

System features and advantages

- Integrated 'LUX System'
- Features revolutionary 'CLEAR VIEW System'
- No assembly required
- Lens attached
- Includes Insufflator with reservoir and pressure release valve
- SIGMOLUX®, including the battery LED and insufflator, is simply dropped into the clinical waste bin after use, saving time, money and effort

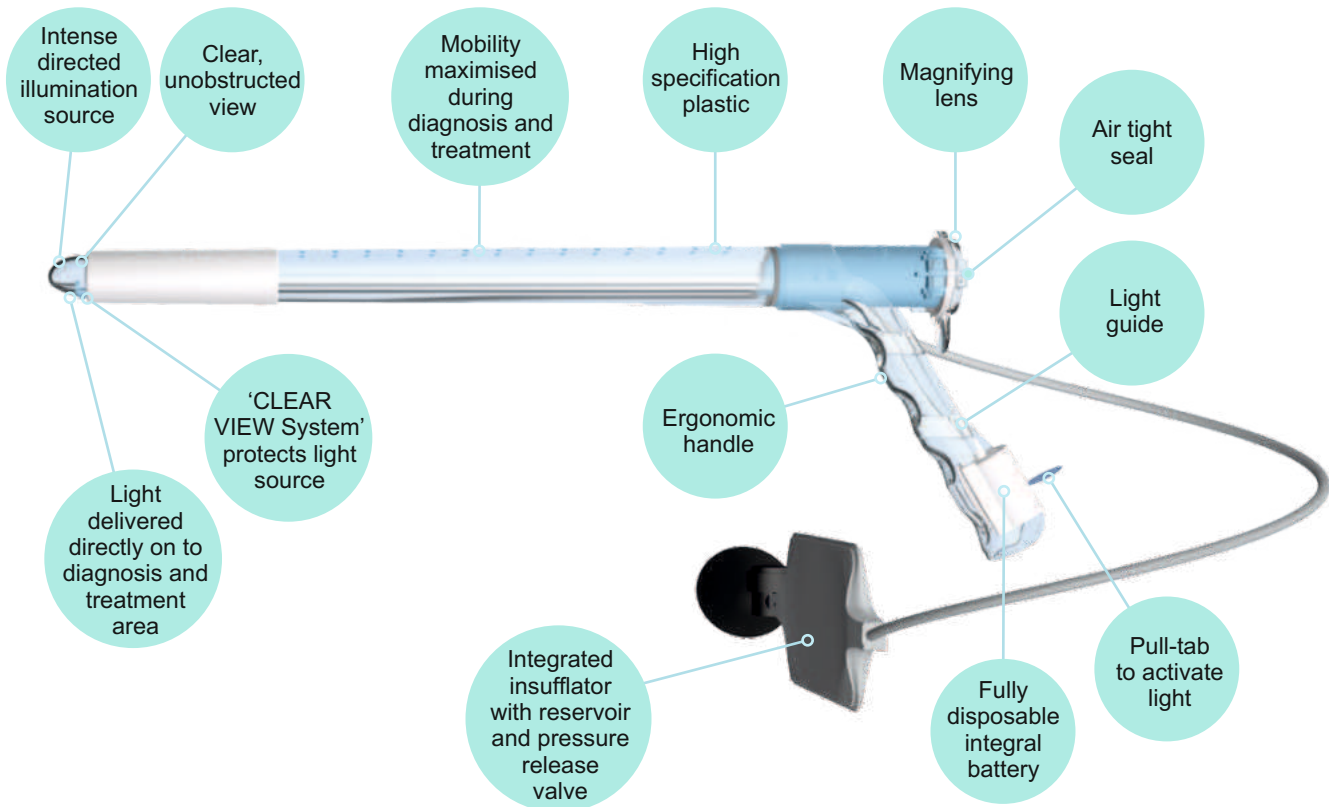

SIGMOLUX® is supplied fully assembled and complete with insufflator for inflating the bowel and includes a lens to provide a clear view of the observation area. SIGMOLUX® uses the revolutionary designed and patented 'CLEAR VIEW System' which protects the light guide to give a clear and unobstructed view of the examination area.



Cat No	Pack	Price	4+
00337	25	243.75	219.38



Section 11 - Gynaecological Products

Ultraspec - Vaginal Speculum

- **Large, smooth spinning nut** - Fast, single-handed operation and easy grip
- **Large access opening** - Increased visibility and improved access for instruments
- **Highly flexible** - When locked open the Ultraspec can be forced completely closed without breaking
- **Large finger grip** - Greater surface area with enhanced grip for ease of use
- **Top-class packaging** - Delivered to you packed in neat, recyclable cartons
- **Pink tint** - Feminine and reassuring, whilst maintaining excellent clarity



Cat No	Length	Open Position	Width at	Pack	Price	72+
		Size	Tip			
M477B	Small (104mm)	66mm-x deg	20mm	100	62.25	59.40
M478B	Medium (120mm)	80mm-x deg	26mm	100	62.25	59.40
M479B	Large (143mm)	90mm-x deg	27.13mm	100	62.25	59.40

Speculux® - Self-Illuminating Vaginal Speculum

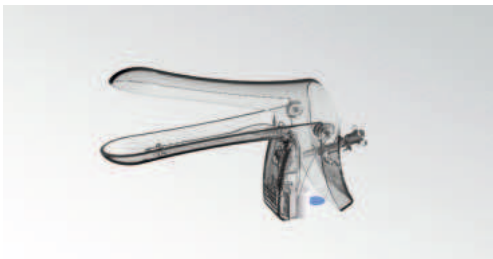

SPECULUX is a range of single use, fully disposable and self-illuminating Vaginal Specula for use in examination, diagnosis and treatment in associated feminine healthcare.

SPECULUX is available with or without a smoke tube for extracting smoke and aerosols produced when using diathermy. In both cases, SPECULUX is supplied in three sizes; small, medium and large with a choice of two closure systems, a screw thread or ratchet mechanism. The configuration versatility combined with the integrated illumination (LUX System) maximises convenience for the medical practitioners.



System features and advantages

- Integrated 'LUX System'
- Extremely versatile configuration options to meet a wide variety of clinical needs
- Available in three sizes; small, medium and large
- Choice of ratchet or screw closure mechanism
- Optional smoke tube for extracting harmful aerosols
- SPECULUX is designed to dislocate and not shatter in the event of excessive force – a safer solution for both patient and medical practitioner
- SPECULUX, including the battery and LED, is simply dropped into the clinical waste bin after use, saving time, money and effort

Cat No	Mechanism	Smoke Tube	Body Size	Open	External	Pack	Price	4+
				Position	Diameter			
00320	Screw	No	Small (104mm)	78mm	24mm	25	97.50	87.75
00321	Screw	No	Medium (120mm)	88mm	26mm	25	97.50	87.75
00322	Screw	No	Large (143mm)	105mm	28mm	25	97.50	87.75
00304	Screw	Yes	Small (104mm)	78mm	24mm	25	120.00	108.00
00305	Screw	Yes	Medium (120mm)	88mm	26mm	25	120.00	108.00
00306	Screw	Yes	Large (143mm)	105mm	28mm	25	120.00	108.00
00324	Ratchet	No	Small (104mm)	78mm	24mm	25	97.50	87.75
00325	Ratchet	No	Medium (120mm)	88mm	26mm	25	97.50	87.75
00326	Ratchet	No	Large (143mm)	105mm	28mm	25	97.50	87.75
00308	Ratchet	Yes	Small (104mm)	78mm	24mm	25	120.00	108.00
00309	Ratchet	Yes	Medium (120mm)	88mm	26mm	25	120.00	108.00
00310	Ratchet	Yes	Large (143mm)	105mm	28mm	25	120.00	108.00



Section 12 - Ultrasound Products

Henleys Ultrasound Products

Henleys competitively priced Ultrasound Gel is salt-free, non-irritant & non-corrosive. We offer a wide range of gels including (thin) obstetric gel. These gels are suitable for electrical transmissions as well as ultrasound.



Clear Ultrasound Gels



Blue Ultrasound Gels

For easy dispensing, gel pumps and support frames are also available for the 5000g sizes. The 260g bottles feature a novel, easy-to-use twist-top cap and, where cross contamination is an issue, Henleys clear gel is available in a 25g single-patient sachet.

The unique twist-top dispensing cap is provided with all Henleys 260g bottles, including Blue, Clear and Obstetric Gels.



Cat No		Pack	Price	8+	16+
H36125GC	HENLEYS ULTRASOUND GEL 25g CLEAR	100	24.50	22.50	20.50
H361260G	HENLEYS ULTRASOUND GEL 260g BLUE	12	12.70	12.35	11.55
H361260GC	HENLEYS ULTRASOUND GEL 260g CLEAR	12	12.70	12.35	11.55
H361KG1	HENLEYS ULTRASOUND GEL 1000g BLUE	Each	3.05	2.95	2.70
H361KG1C	HENLEYS ULTRASOUND GEL 1000g CLEAR	Each	3.05	2.95	2.70
H361KG5	HENLEYS ULTRASOUND GEL 5000g BLUE	Each	13.95	11.75	10.95
H361KG5C	HENLEYS ULTRASOUND GEL 5000g CLEAR	Each	13.95	11.75	10.95
H381260G	HENLEYS OBSTETRIC GEL 260g BLUE	12	12.70	12.35	11.55
H381KG5	HENLEYS OBSTETRIC GEL 5000g BLUE	Each	13.95	11.75	10.95
363US5SP	GEL FRAME for 5000g/5lt GEL	Each	29.95		
363US5PG	PUMP DISPENSER FOR 5000g/5lt GEL	Each	7.99		

Parker Ultrasound Products

Parker is the world standard for medical ultrasound transmission.

AQUASONIC® 100 is the most widely used gel for diagnostic and therapeutic medical ultrasound. Recommended for all procedures where a viscous gel is required. The range includes 20g sterile sachets, 60g Doppler-size tubes, 250g dispenser tubes and the 5lt SONICPAC® complete with refillable dispenser.



Scan®

AQUASONIC CLEAR® Ultrasound Gel. Based on the same "can't be copied" formula of the world standard Aquasonic® 100 Ultrasound Transmission Gel, without fragrance or colour. For diagnostic and therapeutic medical ultrasound procedures.

SCAN®. Parker's exclusive dual-viscosity formula allows SCAN® to be applied as a gel and scan as a fluid. For medical ultrasound procedures when a less viscous gel is desired.

POLYSONIC®. Multipurpose ultrasound lotion with aloe vera, superior coupling efficiency in a pleasing cosmetic-quality base. Recommended for all ultrasound procedures when a lotion is preferred.

Aquasonic® 100



AQUAFLEX® Ultrasound Gel Pad. A 2 x 9cm aqueous, flexible, disposable ultrasound standoff for use in difficult-to-visualize and near-field areas, or when gels alone won't do. Disposability eliminates the risk of cross-contamination in diagnostic and therapeutic ultrasound procedures.

Aquaflex®



Eclipse®



ECLIPSE®. A soft, latex-free, disposable probe cover for medical ultrasound probes/transducers, pre-gelled inside with Aquasonic® 100 Ultrasound Transmission Gel. Fits most endocavity ultrasound probes.

TRANSEPTIC®. Multipurpose cleansing spray for professional use on ultrasound transducer/probe surfaces between procedures or as a cleaning step prior to sterilization. Will not cause transducer membrane swelling.

Cat No		Pack	Price	6+	12+
HM31	PARKER AQUASONIC 100 ULTRASOUND GEL STERILE 20g BLUE	48	61.50	56.75	55.00
0120	PARKER AQUASONIC 100 ULTRASOUND GEL NON-STERILE 20g BLUE	48	49.50		
HM52	PARKER AQUASONIC 100 ULTRASOUND GEL 60g BLUE	12	18.75	18.00	17.50
HM32	PARKER AQUASONIC 100 ULTRASOUND GEL 250g BLUE	12	21.80	21.25	20.15
0134	PARKER AQUASONIC 100 ULTRASOUND GEL 1000g BLUE	12	45.15		
HM33	PARKER AQUASONIC 100 ULTRASOUND GEL 5lt BLUE	Each	18.05	17.50	16.95
HM64	PARKER AQUASONIC CLEAR ULTRASOUND GEL 60g	12	17.95	16.95	16.35
HM62	PARKER AQUASONIC CLEAR ULTRASOUND GEL 250g	12	22.75	21.75	20.75
HM61	PARKER AQUASONIC CLEAR ULTRASOUND GEL 5lt	Each	18.00	17.00	16.00
HM53	PARKER SCAN ULTRASOUND GEL 250g GREEN	12	24.75	23.70	23.25
Cat No		Pack	Price	2+	3+
HM40	PARKER SCAN ULTRASOUND GEL 3.8lt GREEN WITH DISPENSER	4	68.50	66.45	64.60
Cat No		Pack	Price	6+	12+
HM57	PARKER POLYSONIC ULTRASOUND LOTION WITH ALOE VERA 250ml	12	23.75	22.75	21.75
HM34	PARKER AQUAFLEX GEL PAD 2 x 9cm	6	38.65	37.75	36.70
3801	PARKER ECLIPSE ULTRASOUND PROBE COVER 60 x 44 x 241mm	100	61.25		
3803	PARKER ECLIPSE ULTRASOUND PROBE COVER 83 x 43 x 241mm	100	69.25		
HM56	PARKER TRANSEPTIC CLEANSING SOLUTION 250ml	12	74.50	73.50	72.50

Couch Rolls

Couch Rolls are supplied individually cellophane wrapped. Each roll contains 100, 37 x 50cm perforated sheets of white 2-ply paper towel ideal for use in ultrasound applications. Wall-mountable Couch Roll Dispensers are also available.

Cat No		Pack	Price
COUCH20W	WHITE 2-PLY COUCH ROLLS 100 SHEETS, 37x50cm	Each	2.28
COUCHD	COUCH ROLL DISPENSER WALL-MOUNTABLE	Each	25.00



Section 13 - Foetal Dopplers & Transducers

Foetal Dopplers

UJ100S



UJ100S - Convenient, lightweight and easy to use, this homecare foetal heart monitor collects signals from the foetus and broadcasts via the headphones or loudspeaker. Sensitive to foetus of 12+ weeks, this unit can also transmit real-time heartbeat sounds to a PC or internal memory.

UJ100B - Lightweight, handheld and portable, this unit includes a 2/2.5Mhz waterproof probe which is sensitive to foetus of 12+ weeks. It has a large blue backlit LCD display and a clear built-in loudspeaker.



UJ100B



UJ200C

UJ200C - This digital foetal doppler includes a 2.2/3.3Mhz probe which can be selected according to different stages of pregnancy and is sensitive to foetus of 9+ weeks. With simple single-key operation, quality speaker and auto-charge & over-voltage functionality, this unit also includes a large capacity battery capable of 12hrs use on a single charge.

Cat No		Pack	Price
UJ100S	HEMOCARE FOETAL HEART MONITOR	Each	38.58
UJ100B	HAND HELD FOETAL DOPPLER	Each	77.15
UJ200C	DIGITAL FOETAL DOPPLER	Each	277.72

Transducer Belts

Cat No		Pack	Price
E04408	REUSABLE TRANSDUCER BELT 60 x 130cm DARK BLUE	8	37.03
E04308	REUSABLE TRANSDUCER BELT 35 x 130cm LIGHT BLUE	8	37.03



Foetal Event Mark Cable

This 3.0m event mark cable is compatible with Philips/HP, GE Corometrics and Spacelabs foetal monitors.



Cat No		Pack	Price
UREM001	FOETAL EVENT MARK CABLE 3.0m	Each	37.03

Nurse Call Cord

This 3.0m call cord is compatible with most nurse call systems currently available.

Cat No		Pack	Price
UNCC001	NURSE CALL CORD 3.0m	Each	22.22



Section 13 - Foetal Dopplers & Transducers

Foetal Transducers

A range of transducers compatible with the leading brands of foetal monitors.

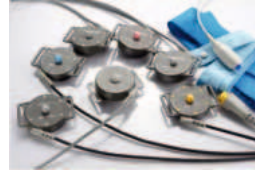

GE Corometrics

116, 118, 120, 129, 150, 151, 155, 170, 171, 173, 250 & 340



Transducer

Type	OEM Ref	Cat No	Pack	Price
U/S	5700LAX	8031014	Each	395.00

GE Corometrics

116, 118, 120, 129, 150, 151, 155, 170, 171, 173, 250 & 340



Transducer

Type	OEM Ref	Cat No	Pack	Price
U/S	5700HAX	8031031	Each	395.00

GE Corometrics

115, 116, 118, 129, 145, 150, 151, 155, 171 & 340



Transducer

Type	OEM Ref	Cat No	Pack	Price
TOCO	2264LAX	8032010	Each	395.00

GE Corometrics

115, 116, 118, 129, 145, 150, 151, 155, 171 & 340



Transducer

Type	OEM Ref	Cat No	Pack	Price
TOCO	2264HAX	8032021	Each	395.00

GE Corometrics

115 & 145



Transducer

Type	OEM Ref	Cat No	Pack	Price
U/S	5600AAX	8031017	Each	395.00

Kranz-Buhler

FC6/8, FS6/8/10

Not illustrated

Transducer

Type	OEM Ref	Cat No	Pack	Price
U/S		8031015	Each	395.00

Kranz-Buhler

Fetacare

Not illustrated

Transducer

Type	OEM Ref	Cat No	Pack	Price
U/S		8031016	Each	395.00

Kranz-Buhler

FC, FS & Fetacare

Not illustrated

Transducer

Type	OEM Ref	Cat No	Pack	Price
TOCO		8032011	Each	395.00

Oxford/Huntleigh

Sonicaid Team/Team Duo 2MHz



Transducer

Type	OEM Ref	Cat No	Pack	Price
U/S	8400-6920	8031039	Each	395.00

Oxford/Huntleigh

Sonicaid Team/Team Duo 1.5 MHz



Transducer

Type	OEM Ref	Cat No	Pack	Price
U/S	8400-6919	8031040	Each	395.00

Oxford/Huntleigh

Sonicaid Team/Team Duo



Transducer

Type	OEM Ref	Cat No	Pack	Price
TOCO	8400-6921	8032026	Each	395.00

Philips/HP

Series 50, 1350



Transducer

Type	OEM Ref	Cat No	Pack	Price
U/S	M1356A	8031012	Each	395.00

Philips/HP

Series 50, 1350



Transducer

Type	OEM Ref	Cat No	Pack	Price
TOCO	M1355A	8032009	Each	395.00

Philips/HP

8040A & 8041A



Transducer

Type	OEM Ref	Cat No	Pack	Price
U/S	15245A	8031013	Each	395.00

Philips/HP

8040A & 8041A



Transducer

Type	OEM Ref	Cat No	Pack	Price
TOCO	15248A	8032025	Each	395.00

Spacelabs

IM76/AM66, Kontron



Transducer

Type	OEM Ref	Cat No	Pack	Price
U/S	US91 AMS-20-0011	8031010	Each	395.00

Spacelabs

IM76/AM66, Kontron



Transducer

Type	OEM Ref	Cat No	Pack	Price
TOCO	TD84 AMS-20-0020	8032007	Each	395.00

Spacelabs

IM77/AM67



Transducer

Type	OEM Ref	Cat No	Pack	Price
U/S	US915 AMS-20-0047	8031011	Each	395.00

Spacelabs

IM77/AM67



Transducer

Type	OEM Ref	Cat No	Pack	Price
TOCO	TD84 AMS-20-0048	8032008	Each	395.00



Section 14 - Surgical Instruments

Low-Temperature Cauteries

Bovie manufacture four different cauteries specifically designed for ophthalmology. These patented Bovie RAM™ cauteries have an impressive four-year shelf-life and are quite simply the best cauteries ever made. With a variety of low temperatures and fine tips the surgeon is assured of precise pinpoint haemostasis. All disposable cauteries are individually packaged sterile, 10 per box. AAA90 has a one-year shelf-life due to use of AAA batteries.



Cat No		Pack	Price
AAA00	BOVIE LOW-TEMPERATURE FINE-TIP CAUTERY 1300°F/704°C	10	67.55
AAA02	BOVIE ADJUSTABLE LOW-TEMPERATURE FINE-TIP CAUTERY 700-1200°F/371-649°C	10	100.17
AAA04	BOVIE LOW-TEMPERATURE ELONGATED FINE-TIP CAUTERY 1100°F/593°C	10	77.62
AAA90	BOVIE LOW-TEMPERATURE FINE-TIP MICRO CAUTERY 850°F/454°C	10	82.98

High-Temperature Cauteries

Bovie manufacture more cauteries than anyone in the world. Therefore, Bovie has the ability to put the right cautery in the physician's hand regardless of the procedure. High-temperature cauteries are popular for many types of procedure including pinpoint haemostasis, evacuation of a subungual haematoma, controlling diffuse bleeders, vasectomies and sculpting woven grafts. Individually packaged sterile, 10 per box.

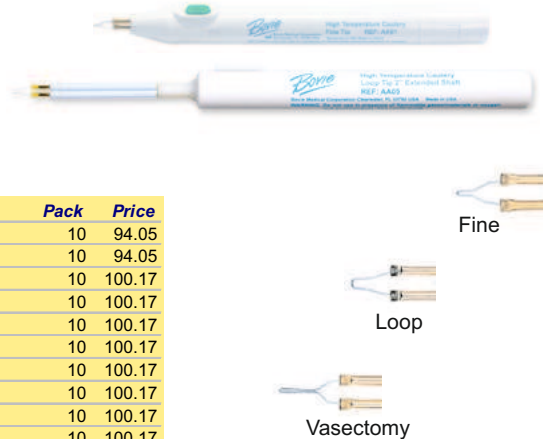

Cat No		Pack	Price
AAA01	BOVIE HIGH-TEMPERATURE FINE-TIP CAUTERY 2200°F/1204°C	10	94.05
AAA03	BOVIE HIGH-TEMPERATURE LOOP-TIP CAUTERY 2200°F/1204°C	10	94.05
AAA05	BOVIE HIGH-TEMPERATURE LOOP-TIP CAUTERY 2200°F/1204°C EXTENDED 2" SHAFT	10	100.17
AAA09	BOVIE HIGH-TEMPERATURE LOOP-TIP CAUTERY 2200°F/1204°C EXTENDED 5" SHAFT	10	100.17
AAA11	BOVIE ADJUSTABLE HIGH-TEMPERATURE FINE-TIP CAUTERY 1500-2100°F/816-1149°C	10	100.17
AAA17	BOVIE HIGH-TEMPERATURE FINE-TIP CAUTERY 2200°F/1204°C EXTENDED 2" SHAFT	10	100.17
AAA21	BOVIE HIGH-TEMPERATURE VASECTOMY-TIP CAUTERY 1800°F/982°C	10	100.17
AAA25	BOVIE HIGH-TEMPERATURE FINE-TIP MICRO CAUTERY 2900°F/1093°C	10	100.17
AAA27	BOVIE HIGH-TEMPERATURE LOOP-TIP MICRO CAUTERY 2000°F/1093°C	10	100.17
AAA29	BOVIE HIGH-TEMPERATURE VASECTOMY-TIP MICRO CAUTERY 1600°F/871°C	10	100.17

Change-A-Tip Cauteries

These replaceable battery & tip cauteries are the next advance in battery operated cauteries where reusability is a must. These products are excellent for use in GP surgeries, theatres and accident & emergency departments for a wide variety of clinical procedures.

Handles



AHIT0 - Change-A-Tip™ low-temperature handle includes one AH100 non-sterile tip and one "AA" alkaline battery.



AHIT1 - Change-A-Tip™ high-temperature handle includes one AH101 non-sterile tip and two "AA" alkaline batteries.

Sterile Tips

Sterile tips include a sterile drape to cover the non-sterile handle. Tips are individually packaged 10 per box.

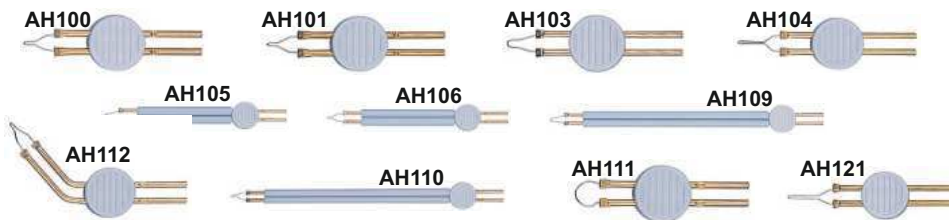

Deluxe Kits



ADEL0 - Change-A-Tip™ deluxe low-temperature cautery kit includes one low-temperature handle, two AH100 non-sterile tips, two AH104 non-sterile tips, one "AA" battery and a foam-lined case.

ADEL1 - Change-A-Tip™ deluxe high-temp cautery kit includes one high-temperature handle, two AH101 non-sterile tips, two AH103 non-sterile tips, two "AA" alkaline batteries and a foam-lined case.

Cat No		Pack	Price
ADEL0	BOVIE CHANGE-A-TIP DELUXE LOW-TEMPERATURE KIT	Each	47.02
ADEL1	BOVIE CHANGE-A-TIP DELUXE HIGH-TEMPERATURE KIT	Each	47.02
ADEL2	BOVIE CHANGE-A-TIP DELUXE HIGH/LOW-TEMPERATURE KIT	Each	59.23
AHIT0	BOVIE CHANGE-A-TIP LOW-TEMPERATURE HANDLE	Each	33.36
AHIT1	BOVIE CHANGE-A-TIP HIGH-TEMPERATURE HANDLE	Each	33.36
AH100	BOVIE LOW-TEMPERATURE FINE CHANGE-A-TIPS	10	47.02
AH101	BOVIE HIGH-TEMPERATURE FINE CHANGE-A-TIPS	10	44.75
AH103	BOVIE HIGH-TEMPERATURE LOOP CHANGE-A-TIPS	10	44.75
AH104	BOVIE HIGH-TEMPERATURE ELONGATED FINE CHANGE-A-TIPS	10	47.02
AH105	BOVIE HIGH-TEMPERATURE 2" FLEX LOOP CHANGE-A-TIPS	10	47.02
AH106	BOVIE HIGH-TEMPERATURE 2" FLEX FINE CHANGE-A-TIPS	10	47.02
AH109	BOVIE HIGH-TEMPERATURE 5" FLEX LOOP CHANGE-A-TIPS	10	47.02
AH110	BOVIE HIGH-TEMPERATURE 5" FLEX FINE CHANGE-A-TIPS	10	47.02
AH111	BOVIE HIGH-TEMPERATURE CIRCULAR CHANGE-A-TIPS	10	47.02
AH112	BOVIE HIGH-TEMPERATURE CONTRA ANGLE FINE CHANGE-A-TIPS	10	47.02
AH121	BOVIE HIGH-TEMPERATURE VASECTOMY CHANGE-A-TIPS	10	47.02

Section 14 - Surgical Instruments

High-Frequency Electrosurgery Generators

Ninety five percent of all procedures performed by a High Frequency Desiccator use ten watts of power or less. The Bovie® DERM101 is an economical, 10 watt High Frequency Desiccator, thoughtfully designed to allow Practitioners the ability to perform minor skin procedures.



			
ADERM101 Unit	AA902 3-Button Handpiece	AA804 Sharp Dermal Tips	AA805 Sharp Dermal Tips
			
AA806 Blunt Dermal Tips (Non Sterile)	AA807 Blunt Dermal Tips (Sterile)	AA806DE Derm-Elite™ Premium Blunt Dermal Tip (Non Sterile)	AA807DE Derm-Elite™ Premium Blunt Dermal Tip (Sterile)
			
AA910ST Disposable Handpiece & Cord Sheath (Sterile)	AA910 Disposable Handpiece Sheath (Non Sterile)	AA837 Wall Mount Kit	

The Bovie® DERM102 has an additional Bipolar mode offering up to 10 watts of power in 1/10th watt increments.



		
AA803 Footswitch*	Reusable Bipolar Forceps* †	AA827V Bipolar Forcep Cable*

*Sold Separately † More styles available

Additional accessories available

Cat No		Pack	Price
ADERM101	BOVIE DERM101 GENERATOR MONOPOLAR	Each	475.00
ADERM102	BOVIE DERM102 GENERATOR MONOPOLAR / BIPOLAR	Each	475.00
AA902	BOVIE 3 BUTTON HAND PIECE	Each	93.25
AA804	BOVIE DISPOSABLE SHARP DERMAL TIP (NON STERILE)	100	43.20
AA805	BOVIE DISPOSABLE SHARP DERMAL TIP (STERILE)	50	55.65
AA806	BOVIE DISPOSABLE BLUNT DERMAL TIP (NON STERILE)	100	43.20
AA807	BOVIE DISPOSABLE BLUNT DERMAL TIP (STERILE)	50	55.65
AA806DE	BOVIE DERM-ELITE PREMIUM BLUNT DERMAL TIP (NON STERILE)	100	43.20
AA807DE	BOVIE DERM-ELITE PREMIUM BLUNT DERMAL TIP (STERILE)	50	55.65
AA910ST	BOVIE DISPOSABLE HAND PIECE AND CORD SHEATH (STERILE)	100	72.00
AA910	BOVIE DISPOSABLE HAND PIECE SHEATH (NON STERILE)	100	15.72
AA837	BOVIE WALL MOUNT KIT FOR DERM101 & DERM102	Each	12.93
AA803	BOVIE BIPOLAR FOOTSWITCH	Each	86.45
AA827V	BOVIE BIPOLAR FORCEP CABLE	Each	35.25

Section 14 - Surgical Instruments

Electrosurgical Pencils

Push Button



Rocker Button



Foot Switch



Reusable Push Button



Scratch Pad & Holster



- Button, rocker, and foot switch models
- Safety designed into every pencil
- Rock solid 3-prong connector
- Removable 2.3 mm (3/32") shaft electrodes
- Ergonomic design

All Bovie electrosurgical pencils feature removable stainless steel electrodes with standard 2.3 mm (3/32") shafts. They are provided with either a standard blade or needle electrode and a rock solid 3-prong connector. To give you the exact switching mechanism you desire, they are available in three versions: button, rocker, or foot-control (single-pin connector on foot-control model). A reusable version is available (AESPR2) which can be autoclaved up to 40 times.

Ergonomically designed, each pencil gives you the balance and feel you demand, reducing stress and allowing you to concentrate on the procedure at hand.

Cat No		Pack	Price
AESP1	BOVIE PUSH-BUTTON PENCIL WITH AES01 BLADE ELECTRODE	50	221.17
AESP1H	BOVIE PUSH-BUTTON PENCIL WITH AES01 BLADE ELECTRODE & HOLSTER	40	190.87
AESP1HS	BOVIE PUSH-BUTTON PENCIL WITH AES01 BLADE ELECTRODE, HOLSTER & SCRATCH PAD	40	215.90
AESP1N	BOVIE PUSH-BUTTON PENCIL WITH AES02 NEEDLE ELECTRODE	50	262.89
AESP1HN	BOVIE PUSH-BUTTON PENCIL WITH AES02 NEEDLE ELECTRODE & HOLSTER	40	235.14
AESP6	BOVIE ROCKER-BUTTON PENCIL WITH AES01 BLADE ELECTRODE	50	220.80
AESP6H	BOVIE ROCKER-BUTTON PENCIL WITH AES01 BLADE ELECTRODE & HOLSTER	40	203.28
AESP6HS	BOVIE ROCKER-BUTTON PENCIL WITH AES01 BLADE ELECTRODE, HOLSTER & SCRATCH PAD	40	229.88
AESP6N	BOVIE ROCKER-BUTTON PENCIL WITH AES02 NEEDLE ELECTRODE	50	279.94
AESP6HN	BOVIE ROCKER-BUTTON PENCIL WITH AES02 NEEDLE ELECTRODE & HOLSTER	40	250.53
AESP7	BOVIE FOOT-SWITCH PENCIL WITH AES01 BLADE ELECTRODE	50	171.36
AESP7H	BOVIE FOOT-SWITCH PENCIL WITH AES01 BLADE ELECTRODE	40	161.72
AESP7HS	BOVIE FOOT-SWITCH PENCIL WITH AES01 BLADE ELECTRODE	40	184.72
AESP7N	BOVIE FOOT-SWITCH PENCIL WITH AES01 BLADE ELECTRODE	50	224.25
AESP7HN	BOVIE FOOT-SWITCH PENCIL WITH AES01 BLADE ELECTRODE	40	203.23
AESPR2	BOVIE REUSABLE PUSH-BUTTON PENCIL (SUPPLIED WITHOUT ELECTRODE)	Each	27.54
AESPRS	BOVIE REUSABLE PUSH-BUTTON PENCIL STERILE (SUPPLIED WITHOUT ELECTRODE)	5	141.75
AESPH	BOVIE PENCIL HOLSTER	40	47.06

Electrosurgical Disposable Electrodes

All Bovie disposable electrodes utilise the standard 2.3mm stainless steel shaft which fits most standard pencils. We stock flat blade, ball, and needle electrodes. All electrodes feature safety grip insulators combining patient and user safety with easy insertion and removal from the surgical pencil. Our electrodes are manufactured to the highest standard and are supplied individually sterile-wrapped.

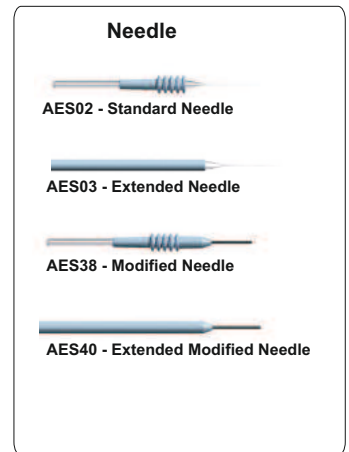
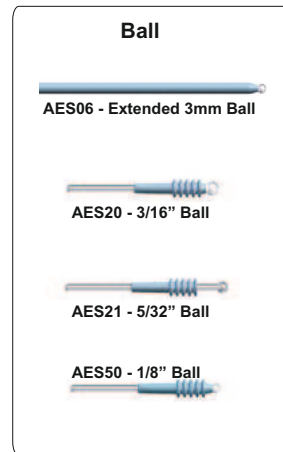
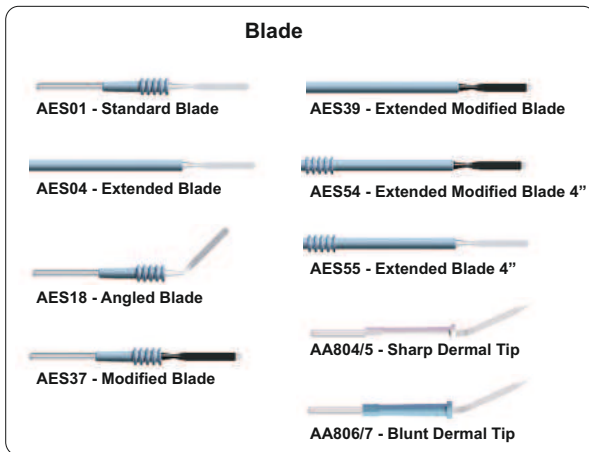

Cat No		Pack	Price
AES01	BOVIE DISPOSABLE STANDARD BLADE ELECTRODE	50	57.81
AES04	BOVIE DISPOSABLE EXTENDED BLADE ELECTRODE	25	83.09
AES18	BOVIE DISPOSABLE ANGLED BLADE ELECTRODE	5	27.50
AES37	BOVIE DISPOSABLE MODIFIED BLADE ELECTRODE	25	60.60
AES39	BOVIE DISPOSABLE EXTENDED MODIFIED BLADE ELECTRODE	25	94.37
AES54	BOVIE DISPOSABLE EXTENDED MODIFIED 4" BLADE ELECTRODE	25	91.72
AES55	BOVIE DISPOSABLE EXTENDED 4" BLADE ELECTRODE	25	72.30
AA804	BOVIE DISPOSABLE SHARP DERMAL TIP FOR BOVIE 800, 900 & 950 (NON STERILE)	100	43.20
AA805	BOVIE DISPOSABLE SHARP DERMAL TIP FOR BOVIE 800, 900 & 950 (STERILE)	50	55.65
AA806	BOVIE DISPOSABLE BLUNT DERMAL TIP FOR BOVIE 800, 900 & 950 (NON STERILE)	100	43.20
AA807	BOVIE DISPOSABLE BLUNT DERMAL TIP FOR BOVIE 800, 900 & 950 (STERILE)	50	55.65
AES06	BOVIE DISPOSABLE EXTENDED 3mm BALL ELECTRODE	5	46.32
AES20	BOVIE DISPOSABLE 3/16" BALL ELECTRODE	25	50.88
AES21	BOVIE DISPOSABLE 5/32" BALL ELECTRODE	25	59.23
AES50	BOVIE DISPOSABLE 1/8" BALL ELECTRODE	25	48.92
AES02	BOVIE DISPOSABLE STANDARD NEEDLE ELECTRODE	25	45.16
AES03	BOVIE DISPOSABLE EXTENDED NEEDLE ELECTRODE	25	106.52
AES38	BOVIE DISPOSABLE MODIFIED NEEDLE ELECTRODE	25	70.65
AES40	BOVIE DISPOSABLE EXTENDED MODIFIED NEEDLE ELECTRODE	25	106.03

Section 14 - Surgical Instruments

Electrosurgical Reusable Electrodes

All Bovie reusable electrodes utilise the standard 3/32" (2.3 mm) stainless steel shaft. They are individually packaged, non-sterile, in a protective box with insert foam.

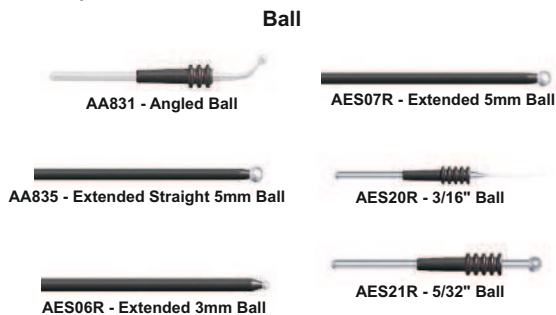
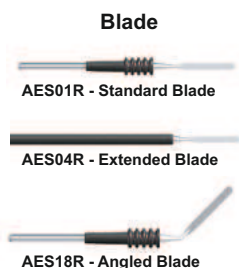
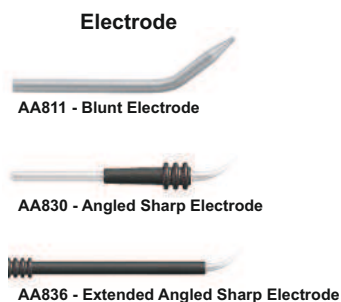

Cat No		Pack	Price
AA811	BOVIE REUSABLE BLUNT ELECTRODE	Each	11.93
AA830	BOVIE REUSABLE ANGLED SHARP ELECTRODE	Each	21.48
AA836	BOVIE REUSABLE EXTENDED ANGLED SHARP ELECTRODE	Each	28.64
AES01R	BOVIE REUSABLE STANDARD BLADE ELECTRODE	Each	10.74
AES04R	BOVIE REUSABLE EXTENDED BLADE ELECTRODE	Each	28.64
AES18R	BOVIE REUSABLE ANGLED BLADE ELECTRODE	Each	12.91
AA831	BOVIE REUSABLE ANGLED BALL ELECTRODE	Each	28.64
AA832M	BOVIE REUSABLE EXTENDED 3/32" BALL ELECTRODE	Each	20.65
AES06R	BOVIE REUSABLE EXTENDED 3mm BALL ELECTRODE	Each	28.64
AES07R	BOVIE REUSABLE EXTENDED 5mm BALL ELECTRODE	Each	28.64
AES20R	BOVIE REUSABLE 3/16" BALL ELECTRODE	Each	21.48
AES21R	BOVIE REUSABLE 5/32" BALL ELECTRODE	Each	21.48
AA833	BOVIE REUSABLE STRAIGHT NEEDLE ELECTRODE	Each	28.64
AA834	BOVIE REUSABLE ANGLED FINE (EPILATION) NEEDLE ELECTRODE	Each	29.02
AES02R	BOVIE REUSABLE STANDARD NEEDLE ELECTRODE	Each	21.48
AES03R	BOVIE REUSABLE EXTENDED NEEDLE ELECTRODE	Each	28.64

Resistick II™ Coated Electrodes

Bovie Resistick II™ coated blade, ball and needle electrodes are expertly coated with PTFE (polytetrafluoroethylene). They move more effectively through tissue because they resist eschar build-up, making them much more efficient during surgical procedures. Just use a damp sponge or cloth to almost effortlessly clean the debris off the Resistick II™ electrodes. Resistick II™ electrodes are supplied individually sterile-packed in boxes of 12.

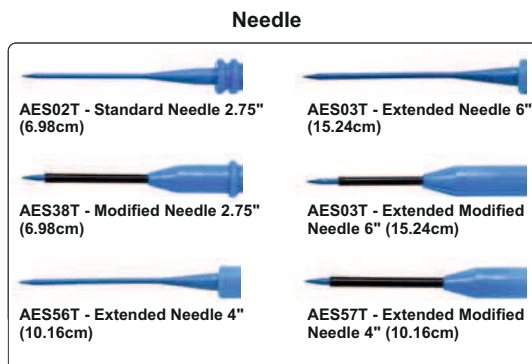

Cat No		Pack	Price
AES01T	RESISTICK II COATED BLADE ELECTRODE 2.75" (6.98cm)	12	40.13
AES04T	RESISTICK II COATED BLADE ELECTRODE 6" (15.24cm)	12	54.67
AES18T	RESISTICK II COATED ANGLED BLADE 45° ELECTRODE 2.75" (6.98cm)	12	61.99
AES37T	RESISTICK II COATED BLADE ELECTRODE WITH EXTENDED INSULATION 2.75" (6.98cm)	12	48.87
AES39T	RESISTICK II COATED BLADE ELECTRODE WITH EXTENDED INSULATION 6" (15.24cm)	12	60.53
AES54T	RESISTICK II COATED BLADE ELECTRODE WITH EXTENDED INSULATION 4" (10.16cm)	12	54.67
AES55T	RESISTICK II COATED BLADE ELECTRODE 4" (10.16cm)	12	55.86
AES58T	RESISTICK II COATED BLADE ELECTRODE 2.5" (6.35cm)	12	40.13
AES59T	RESISTICK II COATED BLADE ELECTRODE WITH EXTENDED INSULATION 2.5" (6.35cm)	12	46.99
AES06T	RESISTICK II COATED BALL ELECTRODE 3MM DIAMETER 5" (12.70cm)	12	55.58
AES07T	RESISTICK II COATED BALL ELECTRODE 5MM DIAMETER 5" (12.70cm)	12	55.58
AES20T	RESISTICK II COATED BALL ELECTRODE 5MM DIAMETER 2" (5.08cm)	12	40.13
AES21T	RESISTICK II COATED BALL ELECTRODE 4MM DIAMETER 2" (5.08cm)	12	40.13
AES50T	RESISTICK II COATED BALL ELECTRODE 3MM DIAMETER 2" (5.08cm)	12	40.13
AES02T	RESISTICK II COATED NEEDLE ELECTRODE 2.75" (6.98cm)	12	41.28
AES03T	RESISTICK II COATED NEEDLE ELECTRODE 6" (15.24cm)	12	56.73
AES38T	RESISTICK II COATED NEEDLE ELECTRODE WITH EXTENDED INSULATION 2.75" (6.98cm)	12	50.34
AES40T	RESISTICK II COATED NEEDLE ELECTRODE WITH EXTENDED INSULATION 6" (15.24cm)	12	64.54
AES56T	RESISTICK II COATED NEEDLE ELECTRODE 4" (10.16cm)	12	59.45
AES57T	RESISTICK II COATED NEEDLE ELECTRODE WITH EXTENDED INSULATION 4" (10.16cm)	12	59.50



Section 14 - Surgical Instruments

Electrosurgical Loops & Squares

All Bovie LLETZ Loop and Square electrodes feature tungsten wire for superior shape and integrity throughout the excision procedure. They use a standard 3/32" (2.3 mm) shaft. Disposable loops are supplied sterile.

Cat No		Pack	Price
AES08	BOVIE DISPOSABLE LOOP ELECTRODE 5 x 5mm	5	52.18
AES09	BOVIE DISPOSABLE LOOP ELECTRODE 10 x 10mm	5	61.62
AES10	BOVIE DISPOSABLE LOOP ELECTRODE 15 x 8mm	5	52.18
AES11	BOVIE DISPOSABLE LOOP ELECTRODE 15 x 10mm	5	61.62
AES12	BOVIE DISPOSABLE LOOP ELECTRODE 20 x 8mm	5	52.18
AES13	BOVIE DISPOSABLE LOOP ELECTRODE 20 x 15mm	5	61.62
AES31	BOVIE DISPOSABLE LOOP ELECTRODE 20 x 20mm	5	52.18
AES42	BOVIE DISPOSABLE LOOP ELECTRODE 20 x 12mm	5	52.18
AES43	BOVIE DISPOSABLE LOOP ELECTRODE 15 x 15mm	5	52.18
AES44	BOVIE DISPOSABLE LOOP ELECTRODE 15 x 5mm	5	52.18
AES45	BOVIE DISPOSABLE LOOP ELECTRODE 13 x 13mm	5	52.18
AES46	BOVIE DISPOSABLE LOOP ELECTRODE 10 x 5mm	5	52.15
AES47	BOVIE DISPOSABLE LOOP ELECTRODE 25 x 10mm	5	52.15
AES49	BOVIE DISPOSABLE LOOP ELECTRODE 20 x 10mm	5	52.15
AES51	BOVIE DISPOSABLE LOOP ELECTRODE 13 x 8mm	5	52.15
AES52	BOVIE DISPOSABLE LOOP ELECTRODE 10 x 8mm	5	52.15
AES14	BOVIE DISPOSABLE SQUARE ELECTRODE 5 x 5mm	5	52.18
AES15	BOVIE DISPOSABLE SQUARE ELECTRODE 10 x 4mm	5	52.18
AES16	BOVIE DISPOSABLE SQUARE ELECTRODE 10 x 8mm	5	52.18
AES41	BOVIE DISPOSABLE SQUARE ELECTRODE 5 x 10mm	5	50.17
AES08R	BOVIE REUSABLE LOOP ELECTRODE 5 x 5mm	Each	19.91
AES09R	BOVIE REUSABLE LOOP ELECTRODE 10 x 10mm	Each	19.91
AES10R	BOVIE REUSABLE LOOP ELECTRODE 15 x 8mm	Each	19.91
AES11R	BOVIE REUSABLE LOOP ELECTRODE 15 x 10mm	Each	19.91
AES12R	BOVIE REUSABLE LOOP ELECTRODE 20 x 8mm	Each	19.91
AES13R	BOVIE REUSABLE LOOP ELECTRODE 20 x 15mm	Each	19.91
AES31R	BOVIE REUSABLE LOOP ELECTRODE 20 x 20mm	Each	19.91
AES42R	BOVIE REUSABLE LOOP ELECTRODE 20 x 12mm	Each	19.91
AES43R	BOVIE REUSABLE LOOP ELECTRODE 15 x 15mm	Each	19.91
AES44R	BOVIE REUSABLE LOOP ELECTRODE 15 x 5mm	Each	19.91
AES45R	BOVIE REUSABLE LOOP ELECTRODE 13 x 13mm	Each	19.91
AES46R	BOVIE REUSABLE LOOP ELECTRODE 10 x 5mm	Each	19.91
AES47R	BOVIE REUSABLE LOOP ELECTRODE 25 x 10mm	Each	19.91
AES49R	BOVIE REUSABLE LOOP ELECTRODE 20 x 10mm	Each	19.91
AES51R	BOVIE REUSABLE LOOP ELECTRODE 13 x 8mm	Each	19.91
AES52R	BOVIE REUSABLE LOOP ELECTRODE 10 x 8mm	Each	19.91
AES14R	BOVIE REUSABLE SQUARE ELECTRODE 5 x 5mm	Each	19.91
AES15R	BOVIE REUSABLE SQUARE ELECTRODE 10 x 4mm	Each	19.91
AES16R	BOVIE REUSABLE SQUARE ELECTRODE 10 x 8mm	Each	19.91
AES41R	BOVIE REUSABLE SQUARE ELECTRODE 5 x 10mm	Each	19.91



Tungsten Loop, Needle & Arthroscopic Electrodes

All the following Bovie electrodes feature tungsten for superior shape and integrity throughout the excision procedure. They use a standard 3/32" (2.3 mm) shaft. Disposable products are supplied sterile.

Cat No		Pack	Price
AES22	BOVIE DISPOSABLE 1/4" SHORT-SHAFT TUNGSTEN STANDARD LOOP	5	46.05
AES23	BOVIE DISPOSABLE 5/16" SHORT-SHAFT TUNGSTEN STANDARD LOOP	5	46.05
AES24	BOVIE DISPOSABLE 3/8" SHORT-SHAFT TUNGSTEN STANDARD LOOP	5	46.05
AES25	BOVIE DISPOSABLE 1/2" SHORT-SHAFT TUNGSTEN STANDARD LOOP	5	46.05
AES26	BOVIE DISPOSABLE 3/4" SHORT-SHAFT TUNGSTEN STANDARD LOOP	5	46.05
AES228	BOVIE DISPOSABLE 1/4" SHORT-SHAFT TUNGSTEN .008" WIRE LOOP	5	46.05
AES238	BOVIE DISPOSABLE 5/16" SHORT-SHAFT TUNGSTEN .008" WIRE LOOP	5	46.05
AES248	BOVIE DISPOSABLE 3/8" SHORT-SHAFT TUNGSTEN .008" WIRE LOOP	5	46.05
AES258	BOVIE DISPOSABLE 1/2" SHORT-SHAFT TUNGSTEN .008" WIRE LOOP	5	46.05
AES268	BOVIE DISPOSABLE 3/4" SHORT-SHAFT TUNGSTEN .008" WIRE LOOP	5	46.05
AES22R	BOVIE REUSABLE 1/4" SHORT-SHAFT TUNGSTEN .008" WIRE LOOP	Each	19.15
AES23R	BOVIE REUSABLE 5/16" SHORT-SHAFT TUNGSTEN .008" WIRE LOOP	Each	19.15
AES24R	BOVIE REUSABLE 3/8" SHORT-SHAFT TUNGSTEN .008" WIRE LOOP	Each	19.15
AES25R	BOVIE REUSABLE 1/2" SHORT-SHAFT TUNGSTEN .008" WIRE LOOP	Each	19.15
AES26R	BOVIE REUSABLE 3/4" SHORT-SHAFT TUNGSTEN .008" WIRE LOOP	Each	19.15

Cat No		Pack	Price
AAR00	BOVIE DISPOSABLE ARTHROSCOPIC ELECTRODE HOOK 90	5	145.03
AAR01	BOVIE DISPOSABLE ARTHROSCOPIC ELECTRODE HOOK 45	5	145.03
AAR02	BOVIE DISPOSABLE ARTHROSCOPIC ELECTRODE ACROMIOPLASTY	5	145.03
AAR03	BOVIE DISPOSABLE ARTHROSCOPIC ELECTRODE MENISECTOMY	5	145.03

Tungsten Loop Electrodes



Arthroscopic Electrodes

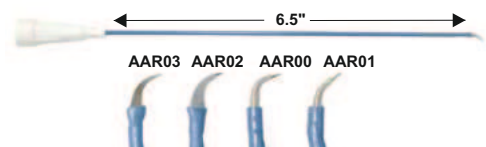

Tungsten Needle Electrodes



ES61HS - Modified Fine Needle with Heatshrink

Cat No		Pack	Price
AES60	BOVIE DISPOSABLE SUPERCUT TUNGSTEN NEEDLE ELECTRODE SUPER FINE 3cm	5	115.96
AES61	BOVIE DISPOSABLE SUPERCUT TUNGSTEN NEEDLE ELECTRODE MODIFIED SUPER FINE 3cm	5	117.09
AES61HS	BOVIE DISPOSABLE SUPERCUT TUNGSTEN NEEDLE ELECTRODE MODIFIED SUPER FINE WITH HEAT SHRINK	5	117.09
AES62	BOVIE DISPOSABLE SUPERCUT TUNGSTEN NEEDLE ELECTRODE SUPER FINE 4.5cm	5	115.96
AES63	BOVIE DISPOSABLE SUPERCUT TUNGSTEN NEEDLE ELECTRODE MODIFIED SUPER FINE 4.5cm	5	117.09
AES60R	BOVIE REUSABLE SUPERCUT TUNGSTEN NEEDLE ELECTRODE SUPER FINE 3cm	Each	32.10
AES62R	BOVIE REUSABLE SUPERCUT TUNGSTEN NEEDLE ELECTRODE SUPER FINE 4.5cm	Each	32.10

Section 14 - Surgical Instruments

Ophthalmic Burr

Bovie Burr 2 includes one disposable 1mm burr tip (A0001) for corneal rust ring removal, "AA" alkaline battery and a foam-lined case. A diamond burr tip (A0011 or A0012) may be purchased separately for use in polishing the pterygium bed after surgical removal and for lid margin lesions.

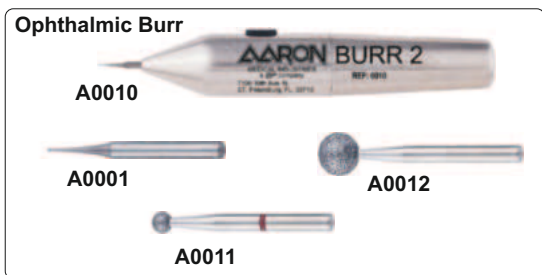

Eye Bubble Bandage

Cat No		Pack	Price
A0010	BOVIE OPHTHALMIC BURR HANDLE	Each	388.81
A0001	BOVIE 1mm BURR TIP	10	75.39
A0011	BOVIE 2.5mm DIAMOND BURR TIP	Each	113.30
A0012	BOVIE 5mm DIAMOND BURR TIP	Each	112.83
A0002	BOVIE EYE BUBBLE BANDAGE STERILE	10	55.27

Nerve Locator

Bovie Neuro-Pulse™ nerve locators were designed to identify exposed motor nerves and at the same time reduce the possibility of accidental nerve damage or severance. These self-powered units are portable and battery operated. Ideal for head, neck, hand, plastic and facial applications.



Cat No		Pack	Price	10+
A0003Y	BOVIE NEURO-PULSE NERVE LOCATOR	Each	45.34	41.08

Flexible Stylets

Flexible Lights - Bovie flexible lights are available sterile in three different sizes, 5", 10" and 15" (refers to the flexible shaft portion of the light).

Lighted Stylets - Designed for difficult intubations.



Sterile Flexible Light

Flexible Lights

Cat No		Pack	Price
AST05	BOVIE SURCHLITE 5" STERILE	10	359.99
AST10	BOVIE SURCHLITE 10" STERILE	3	110.58
AST15	BOVIE SURCHLITE 15" STERILE	3	115.09

Lighted Stylets

Cat No		Pack	Price
ASLOT	BOVIE OROTRACHEAL STYLET STERILE	Each	36.02
ANLOT	BOVIE OROTRACHEAL STYLET NON-STERILE	Each	30.32
APDOT	BOVIE PAEDIATRIC STYLET STERILE	Each	36.13

Speciality Lights

Bovie's diverse line of lights includes their hand-held Woods light, excellent for detecting certain skin disorders and for rape detection procedures.

We also offer the very competitively priced Henley Reusable Pentorch (PT006), which comes complete with a unique lens safety cover and long-life batteries. Supplied in packs of 6.

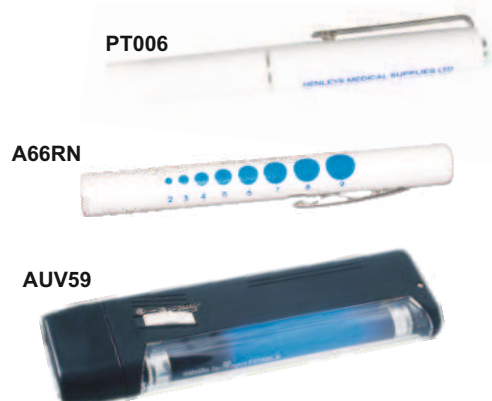

Cat No		Pack	Price	24+
PT006	HENLEY REUSABLE PENTORCH	6	6.99	6.70
A66RN	BOVIE PENLIGHT WITH PUPIL GAUGE	6	8.47	
A6303	BOVIE COBALT PENLIGHT	3	11.50	
A6802	BOVIE BLUE FLUORO-DOT LIGHT	Each	23.43	
A1125	BOVIE DISPOSABLE PENLIGHT	Each	1.25	
AUV59	BOVIE WOODS LIGHT	Each	39.05	



VesselPaws

Reliable atraumatic tissue occlusion - VesselPaws surgical clamp jaw covers provide simple yet effective vessel occlusion, with smooth constant pressure without aggravation and trauma to the vessel being clamped. Made from medical grade silicone, the serrated edges interface to provide smooth, steady, non-slipping tension. VesselPaws are useful anytime a haemostatic clamp is used. Three colour-coded sizes are available, with each sterile pack containing two 5" lengths.



Cat No		Pack	Price	5+
00540	VESSELPAWS MINI RED	20	36.65	35.20
00541	VESSELPAWS MIDI WHITE	20	45.00	43.45
00542	VESSELPAWS MAXI BLUE	20	45.00	43.45

Suture-Boots

Instrument jaw covers facilitate grasping and tagging of sutures - Suture-Boots firmly hold the finest suture without damage or slippage. The radiopaque bright yellow colour provides immediate identification. Five pairs packaged sterile in convenient foam cartridges with pressure-sensitive, peel-off adhesive backing.



Features include

Cost effective pre-cut Suture-Boots eliminate the need to improvise with tubing, catheters or other unsuitable materials. Single-use. Fully tested.

Cat No		Pack	Price	5+
01211	VESSEL CARE SUTURE-BOOTS	250	174.50	167.50

Vesseloops

The original silicone loop. Vesseloops provide smooth vessel occlusion, retraction and identification during surgical procedures. Arteries, veins, tendons, nerves, spermatic cords and intestines are treated gently with a unique elliptical cross-section. Atraumatic Vesseloops are time-proven for reliability and ease of use. Vesseloops are totally non-absorbent and are ideal for a variety of surgical procedures, including: cardiovascular and thoracic surgery for occluding and identifying vessels; vascular surgery to control back bleeding; neurosurgery for occluding arteries in carotid endarterectomy and embolectomy; urological surgery for retracting and identifying ureters. Vesseloops, unlike clamps, do not pinch the vessel flat - a force that often contributes to trauma-provoked atheromas. Clamps can crack the intima, sometimes pulverising and dislodging plaque build-up. Pieces of dislodged plaque can possibly infarct distal organs. Vesseloops are the perfect blend of quick and easy application, coupled with dependable performance. Vesseloops come in three different cross-section sizes for flexibility. They are colour-coded and sterile-packed, two per package. 10 per box.

Cat No		Pack	Price	5+
17731	VESSELOOPS I MINI RED	10 x 2	15.15	14.35
17745	VESSELOOPS I MINI BLUE	10 x 2	15.15	14.35
17766	VESSELOOPS I MINI YELLOW	10 x 2	15.15	14.35
17773	VESSELOOPS I MINI WHITE	10 x 2	15.15	14.35
17801	VESSELOOPS I MAXI RED	10 x 2	15.15	14.35
17822	VESSELOOPS I MAXI BLUE	10 x 2	15.15	14.35
17836	VESSELOOPS I MAXI YELLOW	10 x 2	15.15	14.35
17843	VESSELOOPS I MAXI WHITE	10 x 2	15.15	14.35
17850	VESSELOOPS I SUPERMAXI BLUE	10 x 2	15.15	14.35



Snugger Venous Catheter

The venous catheter is a 190mm long, soft hollow tube manufactured from a medical grade polyvinylchloride (PVC). One end of the tubing has a rounded tip and four rectangular holes. The venous catheter is an accessory to vessel loops/silicone loops which are used for the manipulation and occlusion of blood vessels in thoracic surgery. It is a single-use device sold individually sterile-packed in packs of 100.

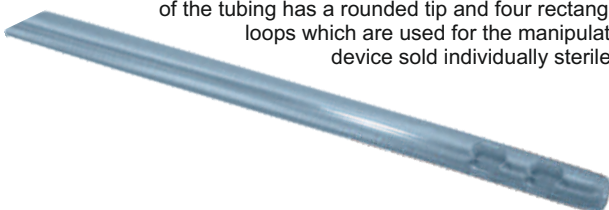

Cat No		Pack	Price
SVC1	SNUGGER VENOUS CATHETER	100	85.55

Section 16 - Vascular & Digestive Catheters

Arterial Embolectomy Catheters

ISOMed Embolectomy Catheters - single or double lumen - are made with X.R.O. PEBAX® and are colour-coded for easy identification. The balloon, fixed with two sutures, is perfectly symmetrical. Embolectomy catheters are graduated every 10cm from the distal end and reinforced with a removable steel wire. The balloon is protected from sunlight by an opaque sheath.

Single Lumen



Size	Length cm	Colour	Pack	Latex		Latex-Free	
				Cat No	Price	Cat No	Price
2Fr	60	GREY	10	300260T	340.00	300260TLF	370.00
2Fr	40	GREY	10	300240T	340.00	300240TLF	370.00
3Fr	80	GREEN	10	300380T	240.00	300380TLF	270.00
3Fr	40	GREEN	10	300340T	240.00	300340TLF	270.00
4Fr	80	RED	10	300480T	240.00	300480TLF	270.00
4Fr	40	RED	10	300440T	240.00	300440TLF	270.00
5Fr	80	WHITE	10	300580T	240.00	300580TLF	270.00
5Fr	40	WHITE	10	300540T	240.00	300540TLF	270.00
6Fr	80	BLUE	10	300680T	240.00	300680TLF	270.00
6Fr	40	BLUE	10	300640T	240.00	300640TLF	270.00
7Fr	80	YELLOW	10	300780T	240.00	300780TLF	270.00
8Fr	80	BROWN	10	300880T	240.00	300880TLF	270.00

Double Lumen



Size	Length cm	Colour	Pack	Latex		Latex-Free	
				Cat No	Price	Cat No	Price
4Fr	80	RED	10	500480	480.00	500480LF	510.00
5Fr	80	WHITE	10	500580	480.00	500580LF	510.00
6Fr	80	BLUE	10	500680	480.00	500680LF	510.00
7Fr	80	YELLOW	10	500780	480.00	500780LF	510.00

Venous Thrombectomy Catheters

ISOMed Thrombectomy Catheters - single lumen - are made with X.R.O. polyurethane and are colour-coded for easy identification. The specially designed balloon, fixed with two sutures, is perfectly symmetrical. Thrombectomy catheters are graduated every 10cm from the distal end and are reinforced with a removable steel wire. The soft and flexible tip of the distal end avoids valve damage.



Size	Length cm	Colour	Pack	Latex		Latex-Free	
				Cat No	Price	Cat No	Price
6Fr	80	BLUE	10	310680	280.00	310680LF	310.00
8Fr	80	BROWN	10	310880	280.00	310880LF	310.00
10Fr	80	GREY	10	311080	280.00	311080LF	310.00

Occlusion Catheters



ISOMed Occlusion Catheters - single lumen - are made with X.R.O. polyurethane and are colour-coded for easy identification. The latex balloon, fixed with two sutures, is perfectly symmetrical. Occlusion catheters are graduated every 10cm from the distal end and are reinforced with a removable steel wire.

Size	Length cm	Colour	Pack	Latex	
				Cat No	Price
7Fr	80	YELLOW	10	320780	380.00
8Fr	80	BROWN	10	320880	380.00

Irrigation Catheters



ISOMed Irrigation Catheters - single lumen - are made with X.R.O. polyurethane and colour-coded for easy identification. Irrigation catheters are graduated every centimetre from the distal end and are reinforced with a removable steel wire.

Size	Length cm	Colour	Pack	Latex		Latex-Free	
				Cat No	Price	Cat No	Price
4Fr	80	RED	10	330480	230.00	330480LF	260.00
5Fr	80	WHITE	10	330580	230.00	330580LF	260.00
6Fr	80	BLUE	10	330680	230.00	330680LF	260.00
8Fr	80	BROWN	10	330880	230.00	330880LF	260.00

Biliary Catheters

ISOMed Biliary Catheters are made with X.R.O. polyurethane and are colour-coded for easy identification. The specially designed balloon, fixed with two sutures, is perfectly symmetrical. Biliary catheters are graduated every centimetre from the distal end and are reinforced with a removable steel wire. The double lumen catheters allow injection and opacification during the procedure.

Single Lumen



Size	Length cm	Colour	Pack	Latex		Latex-Free	
				Cat No	Price	Cat No	Price
5Fr	23	WHITE	10	340523	300.00	340523LF	330.00
5Fr	40	WHITE	10	340540	300.00	340540LF	330.00
6Fr	23	BLUE	10	340623	300.00	340623LF	330.00
6Fr	40	BLUE	10	340640	300.00	340640LF	330.00

Double Lumen



Size	Length cm	Colour	Pack	Latex		Latex-Free	
				Cat No	Price	Cat No	Price
5Fr	40	WHITE	10	540540	475.00	540540LF	505.00
7Fr	40	YELLOW	10	540740	475.00	540740LF	505.00



Section 17 - Respiratory Therapy

Nasal Cannula

All Salter Labs nasal cannula are manufactured to the highest standard and offer an extensive range, including 16SOFT, Original Salter-Style®, Demand, High Flow, Micro and Quiet. You can expect Salter cannulas to provide:

- Curved, tapered nasal prongs
- Comfortably shaped facepieces
- Lightweight feel; not made with natural rubber latex
- Twist-resisting slide bolo
- Quality and wearability

16SOFT - Designed to deliver comfort with soft material in both the tubing and facepiece for a soft-to-the-touch feel throughout.

ORIGINAL - The original Salter-Style® nasal cannula that patients have preferred for over 25 years. Also available in TLC versions for relief of pressure above the ears by using soft adjustable foam cushions.

DEMAND - Specifically designed for dual port oxygen conservation delivery systems.

HIGH FLOW - For oxygen flows up to 15LPM (bright green tubing for identification).

MICRO - With a smaller facepiece for patients who only require flows up to 3LPM.

QUIET - Features a larger reservoir that virtually eliminates noise.

As well as the Salter range Henleys are able to offer cost-effective alternatives for the more popular products.



Cat No	Salter Labs Salter-Style® over-the-ear cannula with three channel safety tubing	Pack	Price	10+
16SOFT0	16SOFT ADULT CANNULA WITHOUT SAFETY TUBING (UP TO 6LPM)	50	31.00	30.00
16SOFT4	16SOFT ADULT CANNULA WITH 1.2m (4ft) SAFETY TUBING (UP TO 6LPM)	50	36.00	35.00
16SOFT7	16SOFT ADULT CANNULA WITH 2.1m (7ft) SAFETY TUBING (UP TO 6LPM)	50	39.50	38.50
16SOFT14	16SOFT ADULT CANNULA WITH 4.2m (14ft) SAFETY TUBING (UP TO 6LPM)	50	67.00	66.00
16SOFT25	16SOFT ADULT CANNULA WITH 7.5m (25ft) SAFETY TUBING (UP TO 6LPM)	50	59.00	58.00
1610	ORIGINAL PREMATURE CANNULA WITH 2.1m (7ft) SAFETY TUBING (UP TO 3LPM)	50	220.00	210.00
1611	ORIGINAL NEONATE CANNULA WITH 2.1m (7ft) SAFETY TUBING (UP TO 3LPM)	50	147.00	146.00
1601	ORIGINAL INFANT CANNULA WITH 2.1m (7ft) SAFETY TUBING (UP TO 3LPM)	50	178.50	173.50
1602	ORIGINAL PAEDIATRIC/SMALL ADULT CANNULA WITH 2.1m (7ft) SAFETY TUBING (UP TO 6LPM)	50	78.00	77.00
16001	ORIGINAL ADULT CANNULA WITH 0.3m (1ft) SAFETY TUBING (UP TO 6LPM)	50	60.70	59.50
16004	ORIGINAL ADULT CANNULA WITH 1.2m (4ft) SAFETY TUBING (UP TO 6LPM)	50	30.50	29.50
1600	ORIGINAL ADULT CANNULA WITH 2.1m (7ft) SAFETY TUBING (UP TO 6LPM)	50	29.50	29.00
160014	ORIGINAL ADULT CANNULA WITH 4.2m (14ft) SAFETY TUBING (UP TO 6LPM)	50	58.00	57.00
160025	ORIGINAL ADULT CANNULA WITH 7.5m (25ft) SAFETY TUBING (UP TO 6LPM)	50	50.35	49.35
1600TLC4	ORIGINAL ADULT CANNULA WITH 1.2m (4ft) SAFETY TUBING & TLC CUSHION (UP TO 6LPM)	25	37.50	36.50
1600TLC	ORIGINAL ADULT CANNULA WITH 2.1m (7ft) SAFETY TUBING & TLC CUSHION (UP TO 6LPM)	25	37.00	36.50
480444	DEMAND ADULT CANNULA WITH 1.2m (4ft) SAFETY TUBING (UP TO 6LPM)	50	64.00	63.00
480777	DEMAND ADULT CANNULA WITH 2.1m (7ft) SAFETY TUBING (UP TO 6LPM)	50	67.00	66.00
1600HF7	HIGH FLOW ADULT CANNULA WITH 2.1m (7ft) SAFETY TUBING (UP TO 15LPM)	10	74.00	73.00
1600HF14	HIGH FLOW ADULT CANNULA WITH 4.2m (14ft) SAFETY TUBING (UP TO 15LPM)	10	64.00	63.00
1600HF25	HIGH FLOW ADULT CANNULA WITH 7.5m (25ft) SAFETY TUBING (UP TO 15LPM)	10	47.50	46.50
1616	MICRO ADULT CANNULA WITH 2.1m (7ft) SAFETY TUBING (UP TO 3LPM)	50	29.50	29.00
1600Q	QUIET ADULT CANNULA WITH 2.1m (7ft) SAFETY TUBING (UP TO 8LPM)	50	29.50	29.00
Cat No	Henley over-the-ear cannula	Pack	Price	10+
RTP1014T	NEONATAL CANNULA WITH 2.1m (7ft) ANTI KINK TUBING (UP TO 3LPM)	50	57.50	55.50
RTP1013T	PAEDIATRIC CANNULA WITH 2.1m (7ft) ANTI KINK TUBING (UP TO 6LPM)	50	29.50	29.00
RTP1010TM	ADULT CANNULA WITHOUT TUBING (UP TO 6LPM)	100	43.50	41.50
RTP1200T	ADULT CANNULA WITH 2.1m (7ft) ANTI KINK TUBING (UP TO 6LPM)	50	32.15	31.15

Tender Grip® - Cannula Securement

Designed to hold the Salter cannula head tubing and facepiece in position, this unique skin fixation system was developed for easy application and comfortable use. It allows the skin to breathe, leaving no messy residue, while being practically invisible.

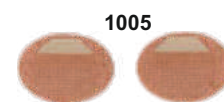

Cat No		Pack	Price
RTP1005	TENDER GRIP FIXATION SYSTEM ADULT	25	55.00
RTP1006	TENDER GRIP FIXATION SYSTEM ADULT	100	79.20
RTP1007	TENDER GRIP FIXATION SYSTEM INFANT	25	87.75
RTP1008	TENDER GRIP FIXATION SYSTEM NEWBORN	25	87.75



Section 17 - Respiratory Therapy

High Concentration Oxygen Masks

Our range includes both the superior quality partial and non-rebreathing masks from the world renowned US manufacturer Salter Labs, as well as our own economical range of non-rebreathing masks.

Typical features include

- ⊙ Precision check valve on all non-rebreathing masks - assures correct oxygen concentration
- ⊙ Soft anatomically formed PVC mask with securely anchored nose clip - better fit for long term users and edentulous patients
- ⊙ Crush-resistant safety tubing - prevents occlusion of the oxygen supply
- ⊙ Supplied in elastic head strap style
- ⊙ Latex-free



Cat No	Salter Labs partial rebreathing mask	Pack	Price	
8120	ADULT MASKS WITH 2.1m (7ft) THREE-CHANNEL SAFETY TUBING	50	61.50	
8125	ADULT MASK WITHOUT TUBING	50	54.50	
1127	PAEDIATRIC MASKS WITH 2.1m (7ft) THREE-CHANNEL SAFETY TUBING	50	119.00	
Cat No	Salter Labs non-rebreathing mask with safety vent	Pack	Price	
8130	ADULT MASKS WITH 2.1m (7ft) THREE-CHANNEL SAFETY TUBING	50	71.00	
8135	ADULT MASK WITHOUT TUBING	50	63.00	
1130	PAEDIATRIC MASKS WITH 2.1m (7ft) THREE-CHANNEL SAFETY TUBING	50	149.00	
Cat No	Salter Labs non-rebreathing mask without safety vent	Pack	Price	
8140	ADULT MASKS WITH 2.1m (7ft) THREE-CHANNEL SAFETY TUBING	50	77.00	
8145	ADULT MASK WITHOUT TUBING	50	68.00	
1140	PAEDIATRIC MASKS WITH 2.1m (7ft) THREE-CHANNEL SAFETY TUBING	50	157.00	
Cat No	Henley non-rebreathing mask with safety vent	Pack	Price	10+
RTP7022T	ADULT MASK WITH 2.1m (7ft) ANTI-KINK TUBING	25	31.50	30.50
RTP7023T	ADULT MASK WITHOUT TUBING	25	30.50	29.50
RTP7061T	PAEDIATRIC MASK WITH 2.1m (7ft) ANTI-KINK TUBING	25	45.50	44.50

Medium Concentration Oxygen Masks



Features & Benefits

- ⊙ Transparent masks with soft anatomical form - better fit for long term patients
- ⊙ Safety tubing - prevents occlusion of oxygen supply
- ⊙ Wide, adjustable elastic strap fits comfortably below the ears to hold mask snugly in place
- ⊙ Elastic strap ends sealed - precludes band from being pulled through mask
- ⊙ Latex Free



Cat No	Salter medium concentration masks	Pack	Price	
8110	ADULT OXYGEN MASK WITH 2.1m (7ft) THREE-CHANNEL SAFETY TUBING	50	44.50	
8115	ADULT OXYGEN MASK WITHOUT TUBING	50	35.50	
1122	PAEDIATRIC OXYGEN MASK WITH 2.1m (7ft) THREE-CHANNEL SAFETY TUBING	50	57.00	
1123	PAEDIATRIC OXYGEN MASK WITHOUT TUBING	50	44.50	
Cat No	Henley medium concentration masks	Pack	Price	10+
RTP7012T	ADULT OXYGEN MASK WITHOUT TUBING	50	22.25	21.25
RTP7014T	ADULT OXYGEN MASK WITH 2.1m (7ft) ANTI-KINK TUBING	50	34.50	33.50

Oxygen Connecting Tubing

We stock a wide range of Oxygen Connecting Tubes. Various lengths are available with different connection types to suit different regulator standards. The wide-bore connector is tapered and typically used for connection to regulators. Standard connectors are used for connection to oxygen equipment and/or regulators.



Cat No	Standard CLEAR oxygen tubing	Pack	Price	20+
RTP700772	1.83m (6ft) TUBING, 1 x STANDARD 1 x WIDE-BORE CONNECTOR	25	14.00	13.75
RTP700772G	1.83m (6ft) TUBING, STANDARD CONNECTORS	25	11.75	11.50
RTP700784	2.1m (7ft) TUBING, 1 x STANDARD 1 x WIDE-BORE CONNECTOR	25	12.15	11.95
RTP700796	2.44m (8ft) TUBING, 1 x STANDARD 1 x WIDE-BORE CONNECTOR	25	14.45	14.25
RTP700796G	2.44m (8ft) TUBING, STANDARD CONNECTORS	25	12.25	12.00
Cat No	Crush resistant CLEAR oxygen tubing	Pack	Price	
2002	2.1m (7ft) TUBING, ANTI-SLIP STANDARD CONNECTORS	50	19.50	18.50
202525	25m (75ft) TUBING, ANTI-SLIP STANDARD CONNECTORS	25	46.00	45.00
205050	50m (150ft) TUBING, ANTI-SLIP STANDARD CONNECTORS	20	76.00	75.00
Cat No	Crush resistant GREEN oxygen tubing	Pack	Price	
2002G7	2.1m (7ft) TUBING, ANTI-SLIP STANDARD CONNECTORS	50	19.50	
2025G25	25m (75ft) TUBING, ANTI-SLIP STANDARD CONNECTORS	50	46.00	
2050G50	50m (150ft) TUBING, ANTI-SLIP STANDARD CONNECTORS	25	76.00	
Cat No	Accessories	Pack	Price	10+
RTP1205	OXYGEN NUT AND NIPPLE	50	29.00	28.00



Section 17 - Respiratory Therapy

Pre-Filled & Refillable Molecular Humidifiers



For dependable, cost-effective performance, Salter high flow and standard humidifiers are a durable, disposable product that are ideal for use with all oxygen sources: concentrators, liquid, tanks or wall outlets. Unique 360° rectangular diffusion ports offer quiet operation with improved hydration and less system back-pressure.

Our Pre-filled Humidifiers are self-standing and will support a flowmeter. The patented "Dual Chamber" design eliminates the need for overflow spill tubes, as it reduces rainout by remaining in the bottle, not the tubing.



Cat No		Pack	Price	10+
71000	STANDARD BUBBLE HUMIDIFIER 350cc, 3psi POP-OFF	50	89.00	88.00
79000	HIGH FLOW BUBBLE HUMIDIFIER 350cc, 6-15lpm	25	85.00	84.00
79SOFT7	HIGH FLOW HUMIDIFIER KIT WITH 2.1m (7ft) SOFT CANNULA	25	155.00	154.00
79SOFT14	HIGH FLOW HUMIDIFIER KIT WITH 4.2m (14ft) SOFT CANNULA	25	165.00	164.00
79SOFT25	HIGH FLOW HUMIDIFIER KIT WITH 7.5m (25ft) SOFT CANNULA	10	78.00	77.00
RTP0352	PRE-FILLED STERILE WATER WITH ADAPTOR 300ml	20	44.25	42.25
RTP0552	PRE-FILLED STERILE WATER WITH ADAPTOR 500ml	12	43.00	41.00

Divided EtCO₂ Sampling Cannula with O₂ Delivery

The Divided Cannula has all the patient comfort features of Salter cannulas plus a permanent barrier between the nasal prongs. This unique, patented design allows simultaneous oxygen delivery via one nasal prong and end-tidal CO₂ sampling from the other nasal prong. An added exclusive feature are the Salter Eyes® which are safety apertures to reduce possible occlusions. The cannula's innovative design gives end-tidal waveform monitoring quality equal to that obtained with intubated patients.

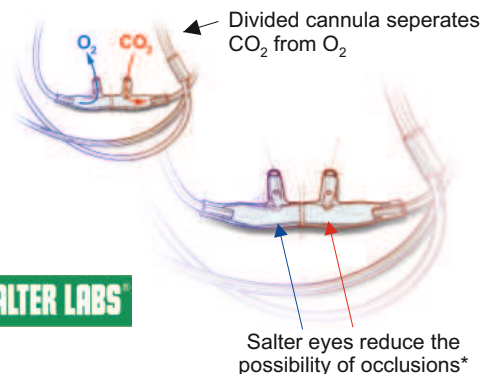

* Salter Labs Technical Report 006.

Cat No		Pack	Price
4706	ADULT EtCO ₂ DIVIDED CANNULA WITH 2.1m (7ft) O ₂ LINE, 5.08cm (2inch) CO ₂ PIGTAIL, MALE LUER LOCK	25	82.20
4706F	ADULT EtCO ₂ DIVIDED CANNULA WITH 2.1m (7ft) O ₂ LINE, 5.08cm (2inch) CO ₂ PIGTAIL, FEMALE LUER LOCK	25	82.20
4707	ADULT EtCO ₂ DIVIDED CANNULA WITH 2.1m (7ft) O ₂ LINE, 2.1m (7ft) CO ₂ LINE, MALE LUER LOCK	25	82.20
4707F	ADULT EtCO ₂ DIVIDED CANNULA WITH 2.1m (7ft) O ₂ LINE, 2.1m (7ft) CO ₂ LINE, FEMALE LUER LOCK	25	82.20
470713	ADULT EtCO ₂ DIVIDED CANNULA WITH 3.9m (13ft) O ₂ LINE, 3.9m (13ft) CO ₂ LINE, MALE LUER LOCK	25	95.00
4702	PAEDIATRIC EtCO ₂ DIVIDED CANNULA WITH 2.1m (7ft) O ₂ LINE, 5.08cm (2inch) CO ₂ PIGTAIL, MALE LUER LOCK	25	120.00
4702F	PAEDIATRIC EtCO ₂ DIVIDED CANNULA WITH 2.1m (7ft) O ₂ LINE, 5.08cm (2inch) CO ₂ PIGTAIL, FEMALE LUER LOCK	25	120.00
4703	PAEDIATRIC EtCO ₂ DIVIDED CANNULA WITH 2.1m (7ft) O ₂ LINE, 2.1m (7ft) CO ₂ LINE, MALE LUER LOCK	25	120.00
4703F	PAEDIATRIC EtCO ₂ DIVIDED CANNULA WITH 2.1m (7ft) O ₂ LINE, 2.1m (7ft) CO ₂ LINE, FEMALE LUER LOCK	25	120.00

EtCO₂ Sampling Cannula Without O₂ Delivery

For CO₂ sampling during spontaneous breathing. Available in adult and paediatric sizes, with connector variations.



Cat No		Pack	Price
40007	ADULT EtCO ₂ CANNULA WITH 2.1m (7ft) CO ₂ LINE, MALE LUER LOCK	25	85.00
40007F	ADULT EtCO ₂ CANNULA WITH 2.1m (7ft) CO ₂ LINE, FEMALE LUER LOCK	25	85.00
41007	PAEDIATRIC EtCO ₂ CANNULA WITH 2.1m (7ft) CO ₂ LINE, MALE LUER LOCK	25	92.00
41007F	PAEDIATRIC EtCO ₂ CANNULA WITH 2.1m (7ft) CO ₂ LINE, FEMALE LUER LOCK	25	92.00



Section 17 - Respiratory Therapy

Salter AIRE Elite™ Compressors for use with Drug Nebulisers



The Salter AIRE Elite™ is a lightweight, portable, quiet compressor for powering aerosol generating medication nebulisers. It is engineered for long-term durability and cost-effectiveness. The flow outlet fitting, fresh air inlet filter and rocker-style on/off switch are recessed to protect from accidental breakage. There is a convenient built-in hand-grip for easy transport. A unique, tip proof nebuliser docking port is built into the case which will accept most medication chambers available on the market today. An optional handy travel bag with extra storage for nebuliser kits is available, making this machine equally suitable for home use.

Specifications
Salter AIRE Elite™, Model SO1774GN Compressor

Size: 14.6 cm x 20.3 cm x 9.5 cm (5.7" L x 7.9" W x 3.7" H)
Weight: 1.8kg (4.0 lbs.)
Electrical requirements: 230 V, 50 HZ, 0.6 A

Flow: ≥ 5 LPM (through a Salter Labs nebuliser)
Pressure: ≥ 30 PSI

Features

- Efficient aerosol delivery
- Solid state components, 5 year warranty
- Lightweight, compact
- Piston-style compressor
- Quiet, low noise level
- Nebuliser docking port

Benefits

- Shorter treatment time, less wasted medication
- Durable & reliable
- Easy to carry, 1.8kg (4.0 lbs.)
- Assures strong, steady pressure and flows
- Provides unobtrusive treatment
- Added safety and convenience



Cat No	Salter AIRE Elite Compressors	Pack	Price
SO1774GN	SALTER AIRE ELITE COMPRESSOR (MAINS ONLY), COMPLETE WITH 8900S NEBULISER KIT	Each	45.00
Cat No	Salter Neb Kits	Pack	Price
8900S	SALTER SERIES 8900 NEBULISER WITH TEE, MOUTHPIECE & 2.1m (7ft) SAFETY TUBING	Each	0.99
8924S	SALTER SERIES 8900 NEBULISER WITH ADULT MASK & 2.1m (7ft) SAFETY TUBING	Each	1.12
8906S	SALTER SERIES 8900 NEBULISER WITH PAEDIATRIC MASK & 2.1m (7ft) SAFETY TUBING	Each	1.45
8960S	SALTER NEBUTECH HIGH DENSITY NEBULISER WITH TEE, MOUTHPIECE & 2.1m (7ft) SAFETY TUBING	Each	3.05
8984S	SALTER NEBUTECH HIGH DENSITY NEBULISER WITH ADULT MASK & 2.1m (7ft) SAFETY TUBING	Each	3.11
8966S	SALTER NEBUTECH HIGH DENSITY NEBULISER WITH PAEDIATRIC MASK & 2.1m (7ft) SAFETY TUBING	Each	3.38
8660S	SALTER REUSABLE NEBUTECH HIGH DENSITY NEBULISER WITH REUSABLE MOUTHPIECE & 2.1m (7ft) SAFETY TUBING	Each	8.30
8980	DISPOSABLE EXHALATION FILTER FOR HIGH DENSITY NEBULISER	10	33.75
8680S	REUSABLE EXHALATION FILTER FOR HIGH DENSITY NEBULISER	Each	9.90
8685	REPLACEMENT FILTER MEDIA FOR REUSABLE EXHALATION FILTER (8680S)	30	25.25
8100S	REPLACEMENT ADULT MASK	Each	0.43
1120S	REPLACEMENT PAEDIATRIC MASK	Each	0.64
825801	SOFT CARRY CASE FOR SALTER AIRE PLUS COMPRESSOR	Each	10.50
8501	SPARE FILTERS FOR SALTER AIRE PLUS	5	1.30
8504	SPARE AIR FILTER CAP FOR SALTER AIRE PLUS	Each	1.50
850112	SPARE FILTERS FOR SALTER AIRE ELITE	5	1.60
85041	SPARE AIR FILTER CAP FOR SALTER AIRE ELITE	Each	0.50

NeNeb Mesh Hand Held Portable Nebulizer



The MyMDI Portable Nebuliser utilises high speed ultrasonic vibration to turn liquid drug into fine mist which is then sent to the respiratory channel by a venting system so that the therapeutic result can be achieved. The nebuliser is compact and portable with an automatic shutdown after 20 minutes or when the medication cup is empty. It produces 100,000 – 120,000 vibrations per second which makes the finest mist particles size of less than 3-5µm. With these precise measurements, the Portable Nebuliser is ideal for clinics, hospitals, first aid settings and for every day asthma management in the home.

Delivery

Ultrasonic Vibration Rate 100,000-120,000 per second
Nebuliser rate 0.2mL/min,-1.0mL/min(Max)
Particle size <5µm
Time AUTO-OFF Power on, operate 20min. Then auto-off
Nebuliser auto-off No medication

Mechanical

Dimension 120mm(h) x 40mm(w) x 70mm(d)
Weight 138g
Bottle Volume 2-8mL
Battery 2 x AA alkaline batteries approx. 1hour (min) of continue operation.

- Utilises ultrasonic vibration to turn a liquid drug into fine mist which is sent to the respiratory tract
- Precise, portable & effective
- Low power consumption
- Light weight
- Low medication residue
- Virtually silent operation
- Built-in low-battery indicator

Cat No	Pack	Price
NENEB	PORTABLE ULTRASONIC NEBULISER	Each 86.00



Salter 8900 Small Volume Drug Nebuliser

The Salter Labs® 8900 Small Volume Jet Nebuliser is a versatile, high performance jet nebuliser which delivers reliable and cost-effective aerosol therapy. Ideally suited for hospital or home therapy. Unique design allows 3cc medication delivery in seven minutes or less, even when held at an angle. The Salter Labs® 8900 Small Volume Jet Nebuliser also works well in ventilator circuits.



Features

- Nebulises 3cc within 7 minutes or less at 7 LPM
- Nebulises in horizontal or vertical position
- Larger surface area provided by unique convex cone design
- Removable green convex cone
- Scalloped, bottom cuff design
- One-eighth turn screw on cap
- Anti-drool "T"

Benefits

- Shortened treatment times
- Allows patient to be in a comfortable position for treatment
- Maximum capillary action eliminates medication waste
- Easy to see and allows for thorough jet cleaning and reassembly
- Allows the unit to stand alone; simplifies tube attachment
- Easy to assemble and disassemble, provides a leak proof seal
- Prevents medication contamination from patient saliva

Cat No	Salter series 8900 nebulisers	Pack	Price
8900	SALTER SERIES 8900 NEBULISER WITH TEE, 150mm (6") RESERVOIR TUBE, MOUTHPIECE & 2.1m (7ft) SAFETY TUBING	50	49.50
8924	SALTER SERIES 8900 NEBULISER WITH ADULT MASK & 2.1m (7ft) SAFETY TUBING	50	56.25
8906	SALTER SERIES 8900 NEBULISER WITH PAEDIATRIC MASK & 2.1m (7ft) SAFETY TUBING	50	72.50
8100	REPLACEMENT MASK ADULT	50	21.50
1120	REPLACEMENT MASK PAEDIATRIC	50	32.00

Salter NebuTech® HDN Small Volume Drug Nebuliser

Both the single-patient use and the reusable version provide a 50cc bolus at the beginning of inspiration. Continuous flow delivers additional medication through the inspiratory cycle. The unique valve system allows re-charge of the medication bolus during exhalation phase with minimal medication waste. Disposable NebuTech® nebulisers are intended for single patient use for up to 7 days, reusable versions for up to 6 months.



Features

- Integral anti-drool feature incorporated
- Patented cone design with larger surface area coupled with more efficient flow-through chamber
- Nebulises 3cc within 7 minutes or less at 7 LPM in horizontal or vertical position
- Particle size distribution within the desired respirable range. 80% below 5 microns
- Incorporates one-way valves at the inlet and outlet paths
- Removable green convex cone

Benefits

- Prevents medication contamination from patient saliva
- Provides maximum capillary action. Better evacuation of medication through the nebuliser
- Reduced treatment time with higher output. Allows patient to be in a comfortable position for treatment
- Improved deposition with peripheral airways. Clinically effective therapy
- Provides minimal loss of costly medication during the non-inhalation phase
- Allows easy cleaning and reassembly

Cat No	Salter High Density Nebulisers	Pack	Price
8960	SALTER NEBUTECH HIGH DENSITY NEBULISER WITH TEE, 150mm (6") RESERVOIR TUBE, MOUTHPIECE & 2.1m (7ft) SAFETY TUBING	50	152.50
8984	SALTER NEBUTECH HIGH DENSITY NEBULISER WITH ADULT MASK & 2.1m (7ft) SAFETY TUBING	50	155.50
8966	SALTER NEBUTECH HIGH DENSITY NEBULISER WITH PAEDIATRIC MASK & 2.1m (7ft) SAFETY TUBING	50	168.80
8660	SALTER REUSABLE NEBUTECH HIGH DENSITY NEBULISER WITH REUSABLE MOUTHPIECE & 2.1m (7ft) SAFETY TUBING	50	415.00
8980	DISPOSABLE EXHALATION FILTER FOR USE WITH HIGH DENSITY NEBULISER	10	33.75
8680	REUSABLE EXHALATION FILTER FOR USE WITH HIGH DENSITY NEBULISER	25	221.00
8685	REPLACEMENT FILTER MEDIA FOR REUSABLE EXHALATION FILTER (8680)	30	25.25
8100	REPLACEMENT MASK ADULT	50	21.50
1120	REPLACEMENT MASK PAEDIATRIC	50	32.00



Section 17 - Respiratory Therapy

Henley Nebuliser Kits

- Consistent particle size of <5 microns (tested at 8LPM)
- Nebulises in an upright position at 90 degrees
- Anti-spill design prevents loss of medication
- Available in adult mask, paediatric mask or mouthpiece kits
- Nebulises up to 3cc medication
- Single patient use
- Latex free



Cat No		Pack	Price	10+
RTP4317U	HENLEY NEBULISER WITH ADULT MASK & 2.1m (7ft) SAFETY TUBING	100	106.00	102.00
RTP4319U	HENLEY NEBULISER WITH PAEDIATRIC MASK & 2.1m (7ft) SAFETY TUBING	100	128.00	118.00
RTP4207U	HENLEY NEBULISER WITH TEE, 150mm (6") RESERVOIR TUBE, MOUTHPIECE & 2.1m (7ft) SAFETY TUBING	100	98.00	92.00

Aerosol Masks & Face Tents



Features & Benefits

- Exceptionally comfortable for even hard-to-fit faces - Maintains proper positioning.
- Soft, clear aerosol mask with anatomical fit and adjustable elastic head strap - Ideal for long-term users or edentulous patients.
- Clear, soft face tent with wide, adjustable elastic head strap - Provides an oxygen- or aerosol-rich environment and a more comfortable fit.

Cat No	Salter Aerosol Mask & Face Tent	Pack	Price	10+
8100	ADULT AEROSOL MASK	50	21.50	
1120	PAEDIATRIC AEROSOL MASK	50	32.00	
RTP1110	ADULT FACE TENT	50	82.00	80.00

MDI Space Chambers

Recommended for delivering respiratory medication via ANY (pMDI) metered dose inhaler.

- Cross Valve Technology™ ensures very low resistance during inhalation and also allows easy exhalation through the chamber.
- Transparent polycarbonate chamber.
- Respiratory valves and their movement can be easily seen, allowing confirmation of correct product operation and usage.
- Compatible with all types of MDI (Metered Dose Inhaler).
- 22 mm outer diameter can be used with any international standard facemask.
- Compact version easily fits into school bags, handbags or briefcases to allow easier storage and handling.
- Universal inhaler base.
- Single patient use.
- Dishwasher Safe.
- Guaranteed for 12months.



Cat No		Pack	Price
SPSPAPE	SPACE CHAMBER PLUS	Each	12.00
SPSPAPMS	SPACE CHAMBER PLUS WITH SMALL MASK	Each	9.22
SPSPAPMM	SPACE CHAMBER PLUS WITH MEDIUM MASK	Each	9.22
SPSPAPML	SPACE CHAMBER PLUS WITH LARGE MASK	Each	9.22
SPSPAPR	SPACE CHAMBER PLUS AUTOCLAVABLE VERSION	Each	14.95
SPSPAPRMP	REPLACEMENT MOUTHPIECE FOR SPSPARR	Each	1.65
SPSPAPCE	COMPACT SPACE CHAMBER PLUS	Each	12.00
SPSPAPSS	COMPACT SPACE CHAMBER PLUS WITH SMALL MASK	Each	9.22
SPSPAPSM	COMPACT SPACE CHAMBER PLUS WITH MEDIUM MASK	Each	9.22
SPSPAPSL	COMPACT SPACE CHAMBER PLUS WITH LARGE MASK	Each	9.22
CIFMS	REPLACEMENT MASK SMALL	Each	2.45
CIFMM	REPLACEMENT MASK MEDIUM	Each	2.85
CIFML	REPLACEMENT MASK LARGE	Each	2.85



Section 17 - Respiratory Therapy

Incentive Spirometry & Accessories



RTP7000 - The Mediflo Duo is a dual-use incentive spirometer that can be used for both sustained maximal inspiration (SMI) and positive expiratory pressure (PEP) simply by turning the product round and re-attaching the corrugated tubing. During SMI the flow regulation lid allows the unit to be adjusted according to the patient's functional capacity, giving a sense of achievement and increased compliance. Low output values for flow and breathing effort (200ml/sec). During PEP, slow exhalation against resistance of approx 15-20cm H₂O increases intrapulmonary pressure, expands the bronchial system, encourages the transport of secretions by means of bronchial calibre fluctuations and assists treatment of pulmonary emphysema. Clear indication of correct pressure. Flow regulation via metering lid.

Cat No	Pack	Price	10+
RTP7000	MEDIFLO DUO INCENTIVE SPIROMETER WITH PEP	20 134.00	133.00

RTP221200 - The Cliniflo is ideal for SMI treatment in elderly, paediatric or weakened patients. With flow setting as low as 100ml/sec, virtually any patient can sustain the minimum inspiratory effort required for effective therapy. Slow inspirations enhance collateral ventilation, and minimise patient discomfort when performing post-surgical breathing exercises. To adjust the flow rate on Cliniflo, simply rotate the dial on the back of the unit until the arrow points to the desired flow rate. The dial is located on the back so the patient is not tempted to change it to a higher flow rate. A port is provided for easy provision of oxygen during therapy. Cliniflo is supplied with pre-assembled popple tubing, mouthpiece and instructions.



Cat No	Pack	Price
RTP221200	CLINIFLO LOW FLOW BREATHING EXERCISER	12 54.00



RTPTB - Tri-Ball Incentive Spirometer, or Respiratory Exerciser, helps the patient to recover normal respiration following chest or abdominal surgery. TriBall has three chambers - 600, 900 and 1200cc per/sec. Convenient holders for both tubing and mouthpiece.

Cat No	Pack	Price	10+
RTPTB	TRI-BALL 3 BALL INCENTIVE SPIROMETER	12 40.95	38.95

1510002001 - Respirogram Incentive Spirometer is typically used post surgery. Features include three chambers - 600, 900 and 1200cc, with colour-coded balls, filter and mouthpiece holder. The optional Respilift attachment adapts the device for expiratory therapy.

Cat No	Pack	Price	50+
1510002001	RESPIROGRAM INCENTIVE SPIROMETER	Each 4.95	4.75
1510008001	RESPIRLIFT BREATHING EXERCISER	Each 8.00	7.00
1510008009	RESPIRLIFT BREATHING EXERCISER WITH TUBE AND MOUTHPIECE	Each 8.00	7.00



RTPSB - Spiroball Adult Volume Incentive Spirometer 500-4000ml.
RTP259000259 - Spiroball Paediatric Volume Incentive Spirometer 500-2500ml.

The inspiratory flow indicator allows the patient to maintain appropriate flow rates. A scale on both sides of the unit allows visual inspection of inspired volume. Convenient holders for mouthpiece and tubing.

Cat No	Pack	Price	10+
RTPSB	SPIROBALL INCENTIVE SPIROMETER WITH VOLUME INDICATOR 500-4000ml ADULT	12 59.00	57.00
RTP259000259	SPIROBALL INCENTIVE SPIROMETER WITH VOLUME INDICATOR 500-2500ml PAEDIATRIC	12 66.00	63.00

1510007102

1510007202

Respivol Incentive Spirometer for Sustained Maximal Inspiration (SMI). Specially designed for the respiratory rehabilitation of patients affected by COPD or with severely compromised respiratory function. Available in adult (5000ml - Green) and paediatric (2500ml - Blue). Sliding indicators can be used to monitor achieved results.

Cat No	Pack	Price	50+
1510007102	RESPIVOL INSPIRATORY TRAINER 2500ml	Each 7.00	6.00
1510007202	RESPIVOL INSPIRATORY TRAINER 5000ml	Each 7.00	6.00



Section 17 - Respiratory Therapy

EzPAP® Positive Airway Pressure System

Lung expansion therapy to prevent or reverse atelectasis

When incentive spirometry alone won't open patients' airways, consider EzPAP® as your next option. It makes providing positive airway pressure positively easy.

Simply connect to a flow meter (wall air or O₂ for enhanced FiO₂), adjust to 5-15 lpm, and instruct the patient to breathe diaphragmatically through the mouthpiece or mask. No equipment to roll around. No labour-intensive CPT. No extensive training. Just a few minutes as prescribed—not for hours at a time.

EzPAP® features a pressure port for connection to a gauge (recommended for initial use with each patient), and a standard 22mm OD fitting to accommodate a mouthpiece or 3 mask options. The EASY option for atelectasis. Try it once and you'll understand.

Easy to meet individual patient needs

While monitoring with a gauge, slowly adjust the flow meter until the desired airway pressures are reached.

Slow inhalations and exhalations should maintain adequate airway pressure throughout the breathing cycle.

The EzPAP® Positive Airway Pressure System includes the EzPAP® lung expansion device, mouthpiece or cushion mask, pressure port cap, and 2.1m (7ft) of tubing.

Also available with pressure gauge.

EzPAP® Features:

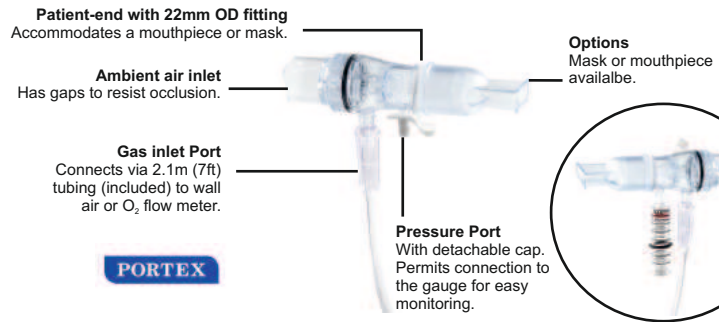

Cat No		Pack	Price
RTP230747	EzPAP WITH MOUTHPIECE	Each	17.25
RTP232747	EzPAP WITH MEDIUM CUSHION MASK	Each	23.00
RTP230757	EzPAP WITH MOUTHPIECE AND PRESSURE GAUGE	Each	21.50

TheraPEP® Positive Expiratory Pressure Therapy System

Improving quality of life

The TheraPEP® System is the proven choice for secretion clearance and reversal of atelectasis^{1,2}

TheraPEP® PEP Therapy System is the easy-to-use system for mobilising secretions in patients with cystic fibrosis (CF), lung diseases with secretory problems and to prevent or reverse atelectasis, as well as patients recovering from surgery.

Designed for positive expiratory pressure therapy and simultaneous aerosol drug delivery, the TheraPEP® System can help virtually any patient mobilise secretions easily, conveniently, and cost-effectively.

Positive expiratory pressure (PEP) therapy with TheraPEP® PEP Therapy System, unlike labour-intensive, time-consuming chest physiotherapy (CPT), can be self-administered by the patient in any setting, helping patients maintain an effective continuum of care outside the hospital. The TheraPEP® System may reduce the need for postural drainage and percussion, and can be performed in less than half the time of a conventional CPT session.³ This offers significant time savings for both patients and clinicians.

The TheraPEP® System is even more efficient when used with a medication nebuliser or MDI spacer. The patient can receive aerosolised medication, and perform therapy for secretion clearance and atelectasis, in the time of one treatment. PEP therapy may also optimise delivery of bronchodilators in patients receiving bronchial hygiene therapy.⁴ No other secretion clearance device offers you a better combination of therapy, flexibility and efficiency.

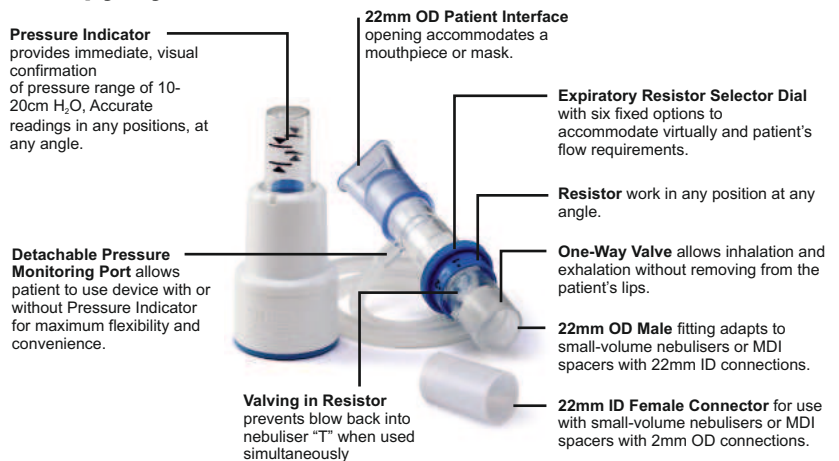

Features

- Six fixed orifice options.
- Built-in durable pressure indicator.
- 22mm OD patient end.
- Inspiratory valve.

Benefits

- Can accommodate virtually any patient's lung capacity.
- Resist breakage, unlike fragile, costly manometers.
- Provides immediate, visual 360° feedback of prescribed pressure.
- May be used with a mask, mouthpiece or nebuliser.
- Allows inhalation and exhalation with removing form mouth.

Cat No		Pack	Price
RTP201112	THERAPEP THERAPY SYSTEM	Each	22.50

1. McIlwaine PM, Wong LT, Peacock D, Davidson GF. Long-term comparative trial of conventional postural drainage and percussion versus positive expiratory pressure physiotherapy in the treatment of cystic fibrosis. J Pediatr. October 1997.
 2. Protocol of the Month, University of Pittsburgh Medical Center, Department of Respiratory Care. AACR Times, May 1997.
 3. Mahlmeister MJ, Fink JB, Hoffman GL, Filer LF. "Positive-expiratory-pressure mask therapy: Theoretical and Practical Considerations and a Review of the Literature", Respiratory Care, 1991;36:1218-1230.
 4. "AACR Clinical Practice: 'Use of Positive Airway Pressure Adjuncts to Bronchial Hygiene Therapy'", Respiratory Care, 1993;38:516-521.

Palm Cups® Manual Percussors

Palm Cups are used during physiotherapy to percuss the chest wall to mobilize the secretions within the bronchial tree. They help provide uniformity and consistency from one user to the next. Primary patients are those with cystic fibrosis, chronic bronchitis and pneumonia. Neonatal and paediatric sizes are packaged individually. Medium and large sizes are packaged in pairs.

Benefits

- Patient comfort.
- Reduces stress on caregivers' joints.
- Provides consistent performance.
- Can accommodate virtually all patients.

Cat No		Pack	Price
RTP554033	PALM CUPS NEONATAL	Each	4.00
RTP554045	PALM CUPS PAEDIATRIC	Each	4.25
RTP554060	PALM CUPS MEDIUM	2	6.85
RTP554090	PALM CUPS LARGE	2	8.15



Section 17 - Respiratory Therapy

PEP/RMT™ Multi-Application Respiratory Training Device

PEP/RMT™ is a simple, easy-to-use training kit designed to improve patient respiratory performance. Choosing from a combination of masks, resistors and other options, you can configure a respiratory training or symptom-minimising tool that can be used in the clinic or at home. PEP/RMT™ can be tailored for four specific therapies covering the full range of patient categories.

- Simple to use and adjust for patients and health care professionals alike
- Multiple scaling options allow you to adjust parameters as patient condition changes
- Quick set-up and breakdown
- Documented effectiveness¹⁻⁴

Resistors



Mask



Manometer



Valve



Tee & Tubing



Carry Case



PEP to normalise reduced lung volumes



PEP can be used to normalise reduced lung volumes which can occur as a result of immobilisation, anaesthesia/surgery and neurological diseases.

PEP to normalise increased lung volumes



PEP can be used to reduce excessive functional residual capacity as in the case of severe stages or exacerbation in obstructive pulmonary disease.

Four respiratory therapies

from a single source

Inspiratory muscle training



IMT can be used to exercise strength and endurance in the inspiratory muscles in patient groups with impaired muscle function, as in chronic obstructive pulmonary disease (COPD) and various neurological diseases. It is also used to lower the risk of postoperative lung complications in patients undergoing heart surgery and for athletes to increase performance.

Secretion elimination with PEP and HiPEP



PEP can be used in the case of increased secretion in the airways, as in cystic fibrosis and COPD and in the case of infection in people with multiple severe disabilities. HiPEP is a method for eliminating secretion from the airways using forced exhalation against an expiratory resistance to residual volume.

References:

1. Ricksten SE, Bengtsson A, Soderberg C, Thorsten M, Kvist H. Effects of periodic positive airway pressure by mask on postoperative pulmonary function. *Chest* 1986;89(6):774-81.
2. Geddes EL, Reid WD, Crowe J, O'Brien K, Brooks D. Inspiratory muscle training in adults with chronic obstructive pulmonary disease: A systematic review. *Respiratory Medicine* 2005;99:1440-58.
3. Elkins MR, Jones A, van der Schans C. Positive expiratory pressure physiotherapy for airway clearance in people with cystic fibrosis. *Cochrane Database Syst Rev* 2006 Apr 19;(2):CD003147.
4. Oberwaldner B, Evans JC, Zach MS. Forced expirations against a variable resistance: A new chest physiotherapy method in cystic fibrosis. *Pediatr Pulmonol* 1986;2:358-67.

Cat No		Pack	Price
H71100	PEP/RMT SET WITH INFANT MASK, 8 RESISTORS, VALVE AND CASE	Each	112.00
H71101	PEP/RMT SET WITH CHILD MASK, 8 RESISTORS, VALVE AND CASE	Each	112.00
H71102	PEP/RMT SET WITH ADOLESCENT MASK, 8 RESISTORS, VALVE AND CASE	Each	112.00
H71103	PEP/RMT SET WITH ADULT MASK, 8 RESISTORS, VALVE AND CASE	Each	112.00
H71104	PEP/RMT SET WITH LARGE ADULT MASK, 8 RESISTORS, VALVE AND CASE	Each	112.00
H71108	PEP/RMT SET WITH MOUTHPIECE, 8 RESISTORS, VALVE AND CASE	Each	112.00
H71109	PEP/RMT MOUTHPIECES	3	9.75
H71110	PEP/RMT MASK SIZE 0, INFANT	Each	45.00
H71111	PEP/RMT MASK SIZE 1, CHILD	Each	45.00
H71113	PEP/RMT MASK SIZE 2, ADOLESCENT	Each	45.00
H71112	PEP/RMT MASK SIZE 3, ADULT	Each	45.00
H71114	PEP/RMT MASK SIZE 4, LARGE ADULT	Each	45.00
H71118	PEP/RMT TRACHEOSTOMY ADAPTOR	Each	8.99
H71119	PEP/RMT VALVE ONLY	Each	45.00
H71120	PEP/RMT RESISTOR SET (1.5-20, 2.5, 3.0, 3.5, 4.0, 4.5, 5.0 cmH2O)	Each	18.50
H71121	PEP/RMT RESISTOR 1.5mm BLACK	5	11.00
H71122	PEP/RMT RESISTOR 2.0mm WHITE	5	11.00
H71123	PEP/RMT RESISTOR 2.5mm YELLOW	5	11.00
H71124	PEP/RMT RESISTOR 3.0mm BLUE	5	11.00
H71125	PEP/RMT RESISTOR 3.5mm GREEN	5	11.00
H71126	PEP/RMT RESISTOR 4.0mm ORANGE	5	11.00
H71127	PEP/RMT RESISTOR 5mm BROWN	5	11.00
H71128	PEP/RMT RESISTOR 6mm PURPLE	5	11.00
H71130	PEP/RMT MANOMETER/PRESSURE GAUGE 0 to 60cm H ₂ O	Each	132.00
H71131	PEP/RMT MANOMETER/PRESSURE GAUGE -30 to +30cm H ₂ O	Each	132.00
H71132	PEP/RMT TEE AND TUBING	Each	8.50
H71133	PEP/RMT REPLACEMENT PRESURE GAUGE WINDOW	Each	7.25



Section 17 - Respiratory Therapy

Acapella® Vibratory PEP Therapy System

Acapella® combines the benefits of both PEP therapy and airway vibrations to mobilise pulmonary secretions and it can be used in virtually any position, whether reclining, standing or sitting.

It improves clearance of secretions, is easier to tolerate than CPT, takes less than half the time of conventional CPT sessions* and facilitates opening of airways in patients with lung diseases with secretory problems (COPD, asthma, cystic fibrosis). Colour-coded units (green for high-flow, blue for low) help customize treatment based on clinical needs. You can adjust Acapella's frequency and flow resistance simply by turning an adjustment dial.



* Mahimeister MJ et al. "Positive-expiratory pressure mask therapy: Theoretical and Practical Considerations and a Review of the Literature", *Respiratory Care*, 1991.

Product Features

- Colour-coded.
- Blue-DM <15 lpm for 3 seconds.
- Green-DH >15 lpm for 3 seconds.
- Inspiratory Valve.
- 22mm OD ambient end.
- 22mm OD patient end.
- Expiratory resistance dial.
- Patented rocker mechanism.

Product Benefits

- Can accommodate virtually any patient's lung capacity.
- Allows inhalation and exhalation without removing from mouth.
- May be used with mask or mouthpiece nebuliser.
- Can accommodate virtually any patient's lung capacity. Reproducible therapies.
- Use in any position - patient is free to sit, stand or recline.

Acapella® Choice Vibratory PEP Therapy System

Like the original Acapella®, Acapella® Choice can be used in virtually any position to open airways and mobilise secretions. What's more, it disassembles into four, easy-to-clean parts that withstand autoclaving, boiling and dishwashing. Your patients get all the benefits of vibratory PEP therapy, in the home or hospital, with a convenient, easy-to-clean device (single-patient use).

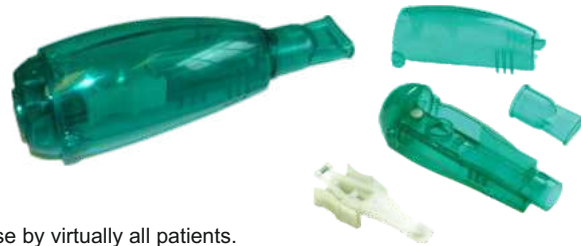

Product Features

- Works in virtually any position.
- Patients may inhale through device.
- 22mm fitting for use with mouthpiece.
- Can be boiled or autoclaved.
- Adjustable frequency with numbered dial.

Product Benefits

- Versatile for use by virtually all patients.
- Easy to clean.
- Enables reproducible therapies.

Acapella® Duet Vibratory PEP Therapy System

The Acapella® Duet is a smart, convenient addition to the popular Acapella® family. The benefits of vibratory PEP therapy have been well documented and now medication can be delivered simultaneously, saving time and effort for both clinicians and patients.



Engineered with a built-in port for aerosolised medication via a small volume nebuliser, Acapella® Duet allows convenient administration of bronchodilator or mucolytic treatments concurrently with vibratory PEP therapy, without the need for a tee adaptor.

Convenient, versatile and smart

Having two therapies — vibratory PEP and nebulised medication — together in one lightweight, compact device helps to further establish Smiths Medical as a leader in providing high-quality, innovative and cost-effective devices for respiratory care.

Product Features

- Vibratory PEP therapy and nebulisation in one device saves time, effort and cost.
- Easily disassembled and reassembled for effortless and thorough cleaning by boiling, autoclaving or in the dishwasher (top rack only).
- Can be used by the patient in any position — reclining, standing or sitting.

Cat No		Pack	Price	10+
RTP211015S	ACAPELLA VIBRATORY PEP DEVICE (LOW FLOW THERAPY)	Each	37.00	
RTP211530S	ACAPELLA VIBRATORY PEP DEVICE (HI FLOW THERAPY)	Each	37.00	
RTP277000	ACAPELLA CHOICE VIBRATORY PEP DEVICE (HI/LOW FLOW THERAPY)	Each	44.50	41.00
279001	ACAPELLA DUET VIBRATORY PEP DEVICE (HI/LOW FLOW THERAPY)	Each	54.25	49.90
RTP200050	ACAPELLA SPARE MOUTHPIECE	Each	0.99	0.95
RTP3102000	FLUTTER MUCUS CLEARANCE DEVICE	Each	49.00	



Section 17 - Respiratory Therapy

Mada Pulmonary Function Filters

Pulmonary function filters help to prevent the risk of bacterial and viral colonisation in equipment. All Mada filters have been tested for bacterial and viral filtration by Nelson Laboratories - USA.

Spirometry Filter "83"

Hydrophobic bidirectional membrane:	TECHN 200
Dead space (connector not included):	51.48cm ³
Filtration area:	53.75cm ²
Bacterial filtration efficiency:	>99.999%
Vital filtration efficiency:	>99.99%
Flow resistance (14 l/s):	0.87cm H ₂ O (l/s)

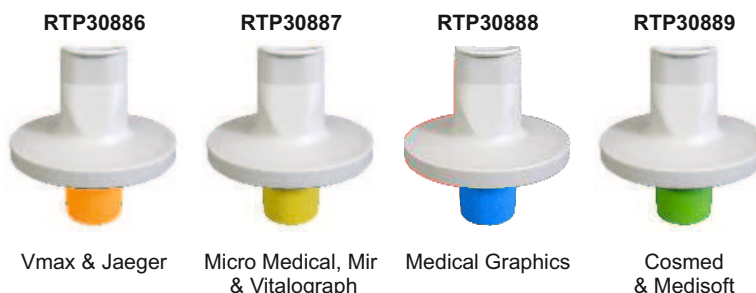

Spirometry Filter "TUBE"

Hydrophobic bidirectional membrane:	TECHN
Dead space (connector not included):	29.52cm ³
Filtration area:	11.46cm ²
Bacterial filtration efficiency:	>99.99%
Vital filtration efficiency:	>99.9%
Flow resistance (14 l/s):	0.93cm H ₂ O (l/s)

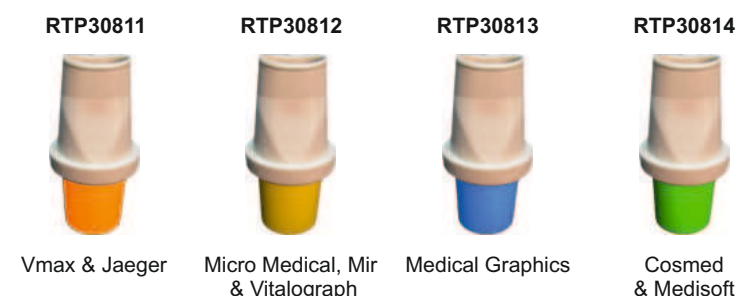

Spirometry Filter "90"

Hydrophobic bidirectional membrane:	TECHN 200
Dead space (connector not included):	58.15cm ³
Filtration area:	62.43cm ²
Bacterial filtration efficiency:	>99.9999%
Vital filtration efficiency:	>99.999%
Flow resistance (14 l/s):	0.87cm H ₂ O (l/s)



Cat No		Pack	Price
RTP30886	MADA 83 FILTER	100	100.49
RTP30887	MADA 83 FILTER	100	100.49
RTP30888	MADA 83 FILTER	100	100.49
RTP30889	MADA 83 FILTER	100	100.49
RTP30811	MADA TUBE FILTER	250	191.40
RTP30812	MADA TUBE FILTER	250	191.40
RTP30813	MADA TUBE FILTER	250	191.40
RTP30814	MADA TUBE FILTER	250	191.40
RTP30890	MADA 90 FILTER	50	48.50

Mada Accessories

Two anatomical mouthpiece options are available to fit Mada 90 filters. Also available is the nose clip.

Cat No		Pack	Price
RTP30863	ANATOMICAL MOUTHPIECE "PLUS"	250	159.00
RTP30861	ANATOMICAL MOUTHPIECE WITH BITE BLOCK	100	92.50
RTP30851BP	NOSE CLIP WITH FOAM PADS	100	79.80
RTP30851M1	NOSE CLIP WITH CUSHIONS	100	73.00



Other Respiratory Filters



Hydrophobic bidirectional membrane:	Electrostatic
Bacterial filtration efficiency:	>99.999%
Vital filtration efficiency:	>99.99%
Flow resistance (30LPM):	40 pa

Cat No		Pack	Price
RTP2110P	BACTERIAL VIRAL FILTER	20	17.00

Section 17 - Respiratory Therapy

Analytical Industries Oxygen Monitor & Analyzer



RTP2000A - Analyzer

- Large backlit LCD display
- Auto diagnostics
- Menu-driven electronics
- Integral tripod stand and dovetail bracket
- Ideal for spot-checking
- 2 year warranty
- Soft touch keypad



RTP2000M - Monitor

- Large backlit LCD display
- Auto diagnostics
- Menu-driven electronics
- Integral tripod stand and dovetail bracket
- Ideal for spot-checking
- 2 year warranty
- User-adjustable alarm (Hi 16-100%, Low 15-99%)
- 120 sec alarm silence for calibration purposes
- Hi alarm defeat for flushing patient with 100% O₂
- Soft touch keypad
- LED Indicators

Specifications

Warm-up time	None required
Display range	0-100% Oxygen
Accuracy	< ± 1% full scale range under constant conditions
Response time	99% of final full scale reading in 9 secs
Sensor life	60 months in air at 25°C and 1 atmosphere
Power supply	2 x AA Alkaline batteries, 1200 hrs continuous use
Temp range	5°C - 45°C
Calibration	Air or certified O ₂ every 8 hrs; time 90 secs
Compensation	Temperature compensated
Connections	1x16mm thread or push-in flow diverter with o-ring seal

Area classification	General purpose
Dimensions	90 x 150 x 40mm
Display	3-½ digit backlit LCD 68x38mm
Display resolution	0.1% O ₂
Flow sensitivity	None between 0.2 to 10LPM
Humidity	Non-condensing 0-95% RH
Linearity	±1% under constant conditions
Pressure	Inlet - ambient; vent - atmosphere
Sensitivity	< 0.5% of full scale range
Signal output	None
Storage temp	-20°C to 60°C on intermittent basis

Cat No		Pack	Price
RTP2000A	OXYGEN ANALYZER COMPLETE WITH SENSOR	Each	250.00
RTP2000M	OXYGEN MONITOR COMPLETE WITH SENSOR	Each	365.00



Section 17 - Respiratory Therapy

Oxygen Sensors Anaesthesia and Respiratory



Cat No	Compatible with	Warranty (Months)	Response (Seconds)	Price (each)	Anaesthesia / Respiratory
RTP1155HL	HEINEN+LOWENSTEIN Leon	15	13	105.00	Anaesthesia
RTP11603	PENLON AV9000. CITYTECH Mox-3	14	13	47.00	Anaesthesia
RTP116008	SENSIDYNE 1000E Analyzer. MINDRAY AS3000	18	6	47.00	Anaesthesia/ Respiratory
RTP1175KE250A	SPACELABS Blease and Sirius	18	6	76.00	Anaesthesia
RTP11915	OHMEDA 4700, 5100, 5120, 5140, 5150, 5250 RGM, 7200, 7800, 7810, Excel Series and Modules series	18	9	53.00	Anaesthesia
RTP119151	DRAGER Narkomed 1A, 2, 2B, 3, 4, 6000, 6400 and Fabius with ext cable	18	9	89.00	Anaesthesia
RTP119152	DRAGER Narkomed 1A, 2, 2B, 3, 4, 6000, 6400 and Fabius with ext cable, Cato and GS	18	9	53.00	Anaesthesia
RTP119153	OHMEDA 5100, 5120, 5140, 5150, 7200, 7800 and 7810	18	9	89.00	Anaesthesia
RTP119154	OHMEDA 7100, 7900 Smart Vent, Aestiva 3000/5, Aespire Vent, ADU (w/holder) and Asys (w/holder), Avance (w/holder)	18	9	53.00	Anaesthesia
RTP11917J2	DATASCOPE Anestar (old style)	18	13	110.00	Anaesthesia
RTP11917J3	DATASCOPE Anestar (new), Taema (France) Alys and Clarys	18	13	58.00	Anaesthesia
RTP11917J7	MINDRAY A5, Wato EX20-EX65, CITYTECH Mox-2	14	13	78.00	Anaesthesia
RTP1160	ANALYTICAL INDUSTRIES 2000, 2000A and 2000M	18	6	58.00	Respiratory
RTP116023	SENSIDYNE 5000M	18	13	47.00	Respiratory
RTP1155	HUDSON RCI 5577, 5590 and 6477	14	9	47.00	Respiratory
RTP1158	HUDSON RCI 5800 and 5801	18	13	58.00	Respiratory
RTP1158HC	HUDSON RCI 5802	14	13	58.00	Respiratory
RTP1177	TELEDYNE/VIAMED 60T, 191 and 200. SECHRIST 650. NEWPORT OM100	18	6	41.00	Respiratory

Section 17 - Respiratory Therapy

Oxygen Sensors Anaesthesia and Respiratory - Continued



Cat No	Compatible with	Warranty (Months)	Response (Seconds)	Price (each)	Anaesthesia / Respiratory
RTP11915G	OHMEDA Giraffe Incubator	14	9	53.00	Respiratory
RTP119152i	DRAGER Babylog Vent, I8000 Incubator, Evita 2 & 4 Vent and Evita XL	18	9	41.00	Respiratory
RTP11917J	LIFECARE PLV102. MEDIX Natalcare Incubator. MSA Mini Ox I, II, III and 3000. PURITAN BENNETT 7820. PHILIPS RESPIRONICS Esprit and V200. PRECISION MEDICAL PM5900 and PM5900L. STEPHAN Christina. TAEMA Ceasar Vent and Eolo Vent. TELEDYNE AX 300 and MX 300	18	13	41.00	Respiratory
RTP11917J1	MAXTEC OM-25A, OM-25E, OM25MEL and MAX-250 ESF	18	13	47.00	Respiratory
RTP11917J6	ENVITEC OOM202-1. IT GAMBERT M-03	15	13	41.00	Respiratory
RTP11917M	CAREFUSION Avea Vent, SiPAP. INFRASONICS Adult Star Vent. SIEMENS 300 & 900 Vents. SPACELABS Gas Analyzer. TAEMA Ceasar (old). VERSAMED eVent. GE iVent	18	13	41.00	Respiratory
RTP11917M1	DATASCOPE Monitor (old)	18	13	58.00	Respiratory
RTP11917M2	PURITAN BENNETT 760 and 840 Ventilator	18	13	41.00	Respiratory
RTP11917MH	CRITICARE Poet. EME Infant Flow Sipap. HAMILTON Arabella CPAP, G5, Galileo and Raphael Vents	18	4	41.00	Respiratory
RTP11917MH1	ATOM V-2100G and V-2200. DRAEGER Airshield Isolette and C2000	14	4	53.00	Respiratory
RTP11917MH3	ATOM 100 and 101	14	4	53.00	Respiratory
RTP1133	HAMILTON Amadeus, Veolar. BIOMED devices	12	30	43.00	Respiratory
RTP11332	HUDSON RCI 5525, 5550, 5552 and 5828	12	30	43.00	Respiratory
RTP1175KE1	MAXTEC OM25A. VAPOTHERM Precision Flow	18	13	58.00	Respiratory
RTP1175KE2	PURITAN BENNETT 740 Vent (old)	18	13	58.00	Respiratory
RTP1175KE4	CAREFUSION Vela. MAXTEC 250K/R125P11-001	24	13	58.00	Respiratory
RTP1175KE6	SLE 2000	18	13	58.00	Respiratory
RTP1175KE8	SLE 5000	18	13	58.00	Respiratory
RTP1175KE9	CAREFUSION/VIASYS Bird Sentry Blender. MAXTEC OM25A, OM25ME, OM25MEL, MaxBlend and Venturi. NEWPORT e360, e500 and HT-70	24	13	60.00	Respiratory
RTP1175KE10	MAXTEC OMO2+A	18	13	58.00	Respiratory



Reusable Bibs

Our PVC Feeder Bibs are made from high quality waterproof heavy duty PVC. They are hand- and machine-washable. Two options are available, with pocket or without pocket. The pocket is designed to catch any waste and further protect the patient and their environment. Our PVC Feeder Bibs have a convenient hook and loop neck fastening.



PVC Feeder Bib

Cat No		Pack	Price
FBHDPLV	PVC BIB 41 x 56cm WITH HOOK AND LOOP FASTENING	Each	3.95
FBHDOV	PVC BIB 41 x 56cm WITH POCKET AND HOOK AND LOOP FASTENING	Each	3.77

Disposable Bibs

Pal Disposable Bibs are 2-ply and constructed using 14gsm polyethylene and 18gsm paper. They are 37 x 50cm with a 10cm pocket.

Cat No		Pack	Price
N12110	DISPOSABLE BIBS 37x50cm, WITH POCKET, WHITE	150	6.25

'Heidi' Drinking Beakers



The lid of the 'Heidi' Drinking Beaker is specifically designed for those patients who have difficulty or find it impossible to take fluids from a conventional cup.

- The unique design of the beaker lid reduces dribble - thus giving the patient more confidence and comfort
- The liquid flow can be regulated, if required, by simply covering a hole on the lid with a finger. This can also allow the use of a straw
- Ideal for nursing staff or attending relatives to administer fluids to patients who cannot help themselves
- Helps to re-educate patients to drink from a cup
- Manufactured from shatterproof polypropylene
- Tight-fitting lid will not come away from beaker but can be removed for cleaning
- Translucent in design for easy visual inspection of contents
- Can be autoclaved or boiled
- Graduated markings every 50ml up to 200ml capacity



Cat No		Pack	Price
115116PP	HENLEY FEEDER BEAKER "HEIDI" PATTERN TRANSLUCENT	Each	1.37

Standard Drinking Beakers



Our standard beakers can be supplied complete with lids or can be purchased separately. All types use the same 116PP beaker so that lids can be interchanged. We offer two types of lids, Wide Spout and Narrow Spout. Both lids have a small hole to allow the user to easily control the flow of fluid. These products are translucent in design for easy visual inspection of contents. They are autoclavable, can be boiled and are microwave safe. The tight-fitting lids ensure that there is little risk of major spillage. Our feeder beakers include clear markings graduated every 50ml up to the 200ml capacity.

Cat No		Pack	Price
113116PP	HENLEY FEEDER BEAKER WITH NARROW SPOUT LID TRANSLUCENT	Each	1.27
113PP	HENLEY NARROW SPOUT LID TRANSLUCENT	Each	0.62
114116PP	HENLEY FEEDER BEAKER WITH WIDE SPOUT LID TRANSLUCENT	Each	1.27
114PP	HENLEY WIDE SPOUT LID TRANSLUCENT	Each	0.62
116PP	HENLEY FEEDER BEAKER WITHOUT TOP TRANSLUCENT	Each	0.72

Double Handle Drinking Beakers



A 260ml cream coloured drinking beaker supplied with two tight-fitting translucent lids. This product has two handles for easy use, can be autoclaved up to 135 degrees and is also microwave safe. The design of the lid allows the use of a straw or the drinking spout shown.

Cat No		Pack	Price
117PP	FEEDER BEAKER WITH TWO HANDLES AND TWO LIDS	Each	1.95

Section 19 - Protective Clothing & Footwear

Disposable Foam Slippers

Pillow Paws® disposable slippers have a non-slip base. Made from odourless polyurethane foam they are available in four colour-coded sizes, each supplied in pairs.



Cat No	Pack	Price
NPPS4 PILLOW PAWS SMALL 11.5-2 GOLD	1 Pair	0.72
NPPS5 PILLOW PAWS MEDIUM 2-5 BLUE	1 Pair	0.77
NPPS6 PILLOW PAWS LARGE 5-8 AVOCADO	1 Pair	0.81
NPPS7 PILLOW PAWS EXTRA LARGE 8-11 BROWN	1 Pair	0.91

Hard Sole Slippers



Our reusable slippers have a rubber sole for good grip and a towelling upper for maximum comfort. These slippers are machine-washable or hand-washable and are available in four colour-coded sizes.

Cat No	Pack	Price	48+
HSS1084 HARDSOLE SLIPPERS SMALL 12-2 GOLD	Pair	4.70	4.55
HSS1085 HARDSOLE SLIPPERS MEDIUM 2-5 LIGHT BLUE	Pair	4.79	4.65
HSS1086 HARDSOLE SLIPPERS LARGE 5-8 GREEN	Pair	4.79	4.65
HSS1087 HARDSOLE SLIPPERS EXTRA LARGE 8-11 TAN	Pair	4.85	4.69

Bed Boots and Bootees

Designed to keep the feet warm and comfortable. Made from 27mm-pile synthetic lambswool fleece on a woven polyester backing with two hook and loop fastenings and a waterproof non-slip sole. Boots are long and designed to cover the ankle and most of the shin. Bootees are smaller and cover the ankle only. These products can be hand-washed or machine-washed. Suitable for use either in or out of bed, the boots fit either foot and are available in three sizes.

Cat No	Pack	Price
H229 SYNTHETIC FLEECE BED BOOT EX LARGE SIZE 9+	Each	8.89
H230 SYNTHETIC FLEECE BED BOOT LARGE SIZE 6 - 9	Each	8.04
H232 SYNTHETIC FLEECE BED BOOT MEDIUM SIZE 3 - 5	Each	7.53
H233 SYNTHETIC FLEECE BED BOOTEE EX LARGE SIZE 9+	Each	8.52
H234 SYNTHETIC FLEECE BED BOOTEE LARGE SIZE 6 - 9	Each	7.17
H236 SYNTHETIC FLEECE BED BOOTEE MEDIUM SIZE 3 - 5	Each	6.80



Poly Overshoes



Deluxe Embossed Sole



Deluxe Smooth Sole



Slip Resistant



CPE



PVC Overshoes

Pal Deluxe Overshoes are manufactured from a strong and durable non-woven fabric. They are a higher specification alternative to CPE overshoes, designed for extra comfort and suitable for more sensitive areas such as laboratories or for visitors to hygiene-sensitive areas. They are available in white or blue, with either a smooth sole or embossed sole for extra grip. One size fits all.

Pal Slip-Resistant Overshoes have been developed specifically to provide the user with maximum grip under both wet and dry conditions. Friction-tested on a variety of floor surfaces including clay tiles, vinyl tiles, polished wood and carpet, these overshoes are independently certified as slip-resistant. They are made from a durable non-woven upper with an elasticated ankle and embossed latex/PE sole offering durability, comfort and grip. They are available in white with blue soles and one size fits all.

PVC Overshoes are manufactured from high quality white anti-static PVC. The semi-disposable design makes these overshoes particularly suitable for tougher application, and being reusable they are an excellent choice for a wide range of tasks where durability is important. PVC Overshoes are available in two sizes and are machine-washable or hand-washable.

Pal CPE Overshoes are made from a high quality embossed polythene, providing strength and grip on slippery floors. They come large (14") as standard but are also available extra-large (16"). CPE overshoes are manufactured with elasticated ankles to ensure a good fit. They are suitable for protecting floors and footwear, ensuring environmental hygiene in a range of applications. Large (14") overshoes are available in four colours, white, blue, green and red. Extra-large (16") overshoes are available in blue only.

Cat No	Pack	Price
N68110 DELUXE OVERSHOES EMBOSSED SOLE, WHITE	200	43.31
N68230 DELUXE OVERSHOES EMBOSSED SOLE, BLUE	200	43.31
N68110CN DELUXE OVERSHOES SMOOTH SOLE, WHITE	250	27.84
N68230CN DELUXE OVERSHOES SMOOTH SOLE, BLUE	250	27.84
N68233 SLIP-RESISTANT OVERSHOES EMBOSSED SOLE, BLUE & WHITE	100	10.98
OASBM PVC ANTI STATIC OVERSHOES MEDIUM 13" WHITE	Pair	6.98
OASBL PVC ANTI STATIC OVERSHOES LARGE 14" WHITE	Pair	6.98
R21113AX CPE OVERSHOES 14", WHITE	100	1.70
R21233AX CPE OVERSHOES 14", BLUE	100	1.70
R21234AX CPE OVERSHOES 16", BLUE	100	1.78
R21333AX CPE OVERSHOES 14", GREEN	100	1.70
R21533AX CPE OVERSHOES 14", RED	100	1.70



Section 19 - Protective Clothing & Footwear

Coveralls

Pal Body Coveralls are made from soft but durable non-woven polypropylene fabric. Pal Body Coveralls are strong, comfortable and individually bagged. They offer hygienic protection in a range of industrial, manufacturing and healthcare environments, with a hood, zipped front and elasticised sleeves for added infection prevention. They are available in 4 sizes. Non-woven body coveralls are suitable for use in the HORECA, food manufacturing and healthcare sectors.



Cat No		Pack	Price
N56112	COVERALL WITH HOOD MEDIUM SIZE	50	64.99
N56113	COVERALL WITH HOOD LARGE SIZE	50	64.99
N56114	COVERALL WITH HOOD EXTRA LARGE SIZE	50	64.99
N56115	COVERALL WITH HOOD EXTRA EXTRA LARGE SIZE	50	64.99

Polythene Aprons

Pal Polythene Aprons are available in a variety of sizes and colours, either on a roll or in a dispensing bag. These aprons have a halter neck and waist ties and slip quickly over your garments to provide maximum protection from any potential spills and splashes during a wide range of tasks, medical procedures, first aid and janitorial duties.



Cat No	Aprons on a roll	Pack	Price
R75110KX	WHITE 690 x 1070mm, 18 MICRONS	200	6.53
R75230KX	BLUE 690 x 1070mm, 18 MICRONS	200	6.53
R75330KX	GREEN 690 x 1070mm, 18 MICRONS	200	7.98
R75530KX	RED 690 x 1070mm, 18 MICRONS	200	7.98
R75610KX	YELLOW 690 x 1070mm, 18 MICRONS	200	7.98
R83110KX	WHITE 760 x 1220mm, 23 MICRONS	200	8.56
R83230KX	BLUE 760 x 1220mm, 23 MICRONS	200	8.56
R83330KX	GREEN 760 x 1220mm, 23 MICRONS	200	8.56
R83530KX	RED 760 x 1220mm, 23 MICRONS	200	8.56
R83520KX	ORANGE 760 x 1220mm, 23 MICRONS	200	8.70
Cat No	Aprons in a dispensing bag	Pack	Price
R93110KX	WHITE 740 x 1200mm, 18 MICRONS	100	2.86
R94110KX	WHITE 650 x 1070mm, 14 MICRONS	100	1.74
R94230KX	BLUE 650 x 1070mm, 14 MICRONS	100	1.74
R94530	RED 690 x 1070mm, 14 MICRONS	100	2.39

PVC Capes & Gowns

Capes are supplied with hook and loop neck fastenings. They are designed to protect the upper shoulder and chest area. Gowns are designed to protect the arms, shoulders and chest area. They are manufactured with full length sleeves and elasticated wrists, plus tying tapes for the neck and waist. Our gowns and capes are produced in lightweight PVC and are machine-washable or hand-washable.

Cat No		Pack	Price
GLWM40	REUSABLE LONG SLEEVE GOWN MEDIUM 48x40" HIP (121.9 - 101.6cm)	Each	18.37
GLWL46	REUSABLE LONG SLEEVE GOWN LARGE 48x46" HIP (121.9 - 116.8cm)	Each	9.03
CLW36V	CAPE 36" DIAMETER WITH VELCRO MAX 21" NECK	Each	6.50
CLW48V	CAPE 48" DIAMETER WITH VELCRO MAX 24" NECK	Each	6.89



PVC Cape



PVC Gown

PVC Aprons

Our range of PVC aprons is supplied in various lengths and available in anti-static, heavy duty and lightweight PVC. Heavy duty and anti-static aprons are manufactured with eyelets at waist and neck height to take tying tapes (supplied). Lightweight aprons are supplied with sewn-in tying tapes. Machine-washable or hand-washable.



Heavy Duty PVC



Lightweight PVC



Anti-Static PVC

Cat No		Pack	Price
AAS42	ANTI-STATIC APRON 42" (106.7cm)	Each	6.49
AAS46	ANTI-STATIC APRON 46" (116.8cm)	Each	6.49
AAS50	ANTI-STATIC APRON 50" (127cm)	Each	8.73
AAS54	ANTI-STATIC APRON 54" (137.2cm)	Each	8.73
AHD42	APRON H/DUTY BLUE 42" (106.7cm)	Each	3.99
AHD46	APRON H/DUTY BLUE 46" (116.8cm)	Each	3.99
AHD50	APRON H/DUTY BLUE 50" (127cm)	Each	4.38
AHD54	APRON H/DUTY BLUE 54" (137.2cm)	Each	4.38
ALW42	APRON L/WT WHITE 42" (106.7cm)	Each	2.91
ALW46	APRON L/WT WHITE 46" (116.8cm)	Each	3.43
ALW50	APRON L/WT WHITE 50" (127cm)	Each	3.95
ALW54	APRON L/WT WHITE 54" (137.2cm)	Each	3.95



Section 19 - Protective Clothing & Footwear

Beard Mask

Pal Beard Masks are made from soft spunbond non-woven fabric. These hygienic masks have soft elastic ear loops offering comfortable and effective barrier protection. They are available in blue or white and one size fits all.



Cat No		Pack	Price
N43110HP	DISPOSABLE BEARD MASK - WHITE	100	2.18
N43230HP	DISPOSABLE BEARD MASK - BLUE	100	2.18

Polythene Oversleeves



Pal Oversleeves are made from a high quality polythene (CPE). With concealed elastic at the wrist and elbow, they offer a secure yet comfortable fit. Designed to offer splash protection and ensure hygiene standards are met in a variety of industrial, manufacturing and healthcare environments. They are available in five colours.

Cat No		Pack	Price
R68110	OVERSLEEVES WHITE	100	1.70
R68220	OVERSLEEVES BLUE	100	1.70
R68330	OVERSLEEVES GREEN	100	1.88
R68530	OVERSLEEVES RED	100	1.88
R68610	OVERSLEEVES YELLOW	100	1.88

PVC Sleeves

PVC sleeves are designed to protect the arms. Supplied with elasticated wrist and elbows with welded seams, PVC sleeves are machine-washable or hand-washable.



Cat No		Pack	Price
SLW	PVC PROTECTIVE SLEEVES 12" (30.5cm)	Pair	1.98

Dispensers



Pal Ecopak Dispenser can be used to dispense a variety of Pal products. This multi-purpose dispenser can be installed horizontally to dispense Pal Aprons on a roll, or vertically to dispense Pal Overshoes and Oversleeves. Not suitable for PVC products.

Cat No		Pack	Price
X64110	PAL DISPENSER	Each	33.50

Gloves

Latex gloves are manufactured to a medical grade 1.5 AQL standard. They are natural-coloured with a beaded cuff to prevent tearing. They are available either pre-powdered for ease of application and to help absorb perspiration, or powder-free for use in highly controlled environments. They are produced in various sizes and are supplied in a convenient dispenser box.



Vinyl gloves are manufactured to 4 AQL from high quality vinyl. Beaded cuffs provide strength and help prevent tearing. They are available pre-powdered to aid application, absorb perspiration and increase user comfort, or powder-free for those with related allergies. Produced in clear vinyl, available in four sizes and supplied in a convenient dispenser box. These gloves are latex-free.



Nitrile gloves are manufactured to a medical grade 1.5 AQL standard. They are a great alternative to latex gloves in almost all environments, offering high dexterity and durability with excellent resistance to oils, acids and other chemicals. They are powder-free and latex-free. They are produced in four sizes, coloured blue and supplied in a convenient dispenser box.



Cat No	Powder-Free Vinyl	Pack	Price
R59001SX	VINYL GLOVES SMALL	100	2.79
R59002SX	VINYL GLOVES MEDIUM	100	2.79
R59003SX	VINYL GLOVES LARGE	100	2.79
R59004SX	VINYL GLOVES EXTRA LARGE	100	2.79
Cat No	Powdered Vinyl	Pack	Price
R69001SX	VINYL GLOVES SMALL	100	2.28
R69002SX	VINYL GLOVES MEDIUM	100	2.28
R69003SX	VINYL GLOVES LARGE	100	2.28
R69004SX	VINYL GLOVES EXTRA LARGE	100	2.28

Cat No	Powder-Free Latex	Pack	Price
R56001	LATEX GLOVES SMALL	100	4.78
R56002	LATEX GLOVES MEDIUM	100	4.78
R56003	LATEX GLOVES LARGE	100	4.78
Cat No	Powdered Latex	Pack	Price
R66001	LATEX GLOVES SMALL	100	4.12
R66002	LATEX GLOVES MEDIUM	100	4.12
R66003	LATEX GLOVES LARGE	100	4.12
R66004	LATEX GLOVES EXTRA LARGE	100	4.12

Cat No	Powder-Free Nitrile	Pack	Price
R51231	NITRILE GLOVES SMALL	100	3.48
R51232	NITRILE GLOVES MEDIUM	100	3.48
R51233	NITRILE GLOVES LARGE	100	3.48
R51234	NITRILE GLOVES EXTRA LARGE	100	3.48

Cat No	Polythene	Pack	Price
R64002	POLYTHENE GLOVES MEDIUM	100	0.68
R64003	POLYTHENE GLOVES LARGE	100	0.68



Polythene gloves offer safe, low-allergy protection for a variety of tasks. These low cost disposable gloves are lightweight, latex-free, powder-free and available in medium and large sizes. They are supplied in convenient bags of 100.



Section 20 - Cushions & Supports

Synthetic Polyester Fleeces

Synthetic Polyester Fleeces with a 27mm-pile depth are a cost-effective alternative to a natural fleece. They are non-allergenic, non-toxic and comply with BS4578 for air permeability. They are also flame-retardant.

Synthetic Polyester Fleeces are machine-washable and hand-washable.

Cat No		Pack	Price
H220	SYNTHETIC FLEECE 18x20" (45.7x50.8cm)	Each	6.92
H221	SYNTHETIC FLEECE 14x18" (35.6x45.7cm)	Each	5.69
H222	SYNTHETIC FLEECE 27x30" (68.6x76.2cm)	Each	12.35
H224	SYNTHETIC FLEECE 27x60" (68.6x152.4cm)	Each	22.49
H225	SYNTHETIC FLEECE 60" WIDE (152.4cm)	Metre	28.78



Real Lambswool Fleeces

Natural Lambswool Fleeces are soft, springy, resilient and typically have a pile depth of around 25mm. They absorb perspiration, which helps to keep the patient dry and comfortable.

Natural Lambswool Fleeces are machine-washable and hand-washable. We recommend that they are brushed with a fine comb for maximum softness.



Cat No		Pack	Price
H222LW	REAL LAMBSWOOL FLEECE 27 X 30" (68.6x76.2cm)	Each	14.37
H224LW	REAL LAMBSWOOL FLEECE 27 X 60" (68.6x152.4cm)	Each	26.61

Cushions

Our range of pressure care products is further complemented with our Ring Cushion and V-Shaped Pillows. These products are used in many applications to provide comfort and relief from painful pressure sores, aches and pains. They are machine-washable or hand-washable and flame-retardant.

Cat No		Pack	Price
H350	RING CUSHION COTTON COVERED	Each	14.84
H370	V-SHAPED PILLOW COTTON COVERED	Each	28.45
H371	POLYESTER COVER FOR V-SHAPED PILLOW	Each	13.52
H371VP	VAPOUR PERMEABLE COVER FOR V-SHAPED PILLOW	Each	23.45
PC1LWVS	PVC COVER FOR V-PILLOW L/WT (FLAP)	Each	11.06
PC2LWVS	PVC COVER FOR V-PILLOW L/WT (ZIP)	Each	4.29
PC3LWVS	PVC COVER FOR V-PILLOW L/WT (HOOK AND LOOP)	Each	21.00



We make to order

If you can't see it just give us a call on 01707 385226. We can often make exactly what you need to your own specification.

Section 20 - Cushions & Supports

Wedges

High quality wedges mostly used to support the patient in bed. Three sizes/angles are available. These products are produced from high quality foam and are covered with a flame-retardant quilted PVC with a zip fastening.

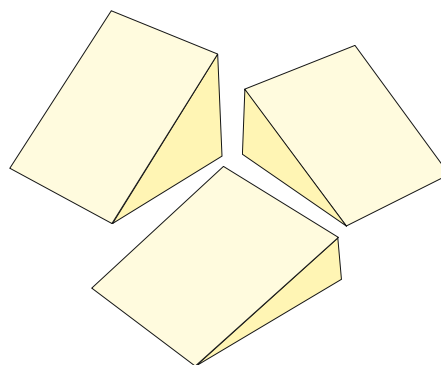

Cat No		Pack	Price
H140	LOW WEDGE (QUILTED PVC COVER) 23x23x7" (58.4x58.4x17.8cm)	Each	35.40
H142	SPARE COVER FOR LOW WEDGE	Each	17.16
H150	MEDIUM WEDGE (QUILTED PVC COVER) 23x23x12" (58.4x58.4x30.5cm)	Each	50.52
H152	SPARE COVER FOR MEDIUM WEDGE	Each	18.46
H160	HIGH WEDGE (QUILTED PVC COVER) 23x23x18" (58.4x58.4x45.7cm)	Each	67.20
H162	SPARE COVER FOR HIGH WEDGE	Each	20.70

Armchair Bedrests

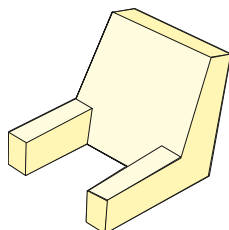

Armchair bedrests are designed to provide an armchair-like seating position within the bed. Specially formed to contour to the patient's upper body, they help maintain the correct postural position. They are covered with a supersoft flame-retardant quilted PVC which is zip fastened.

Cat No		Pack	Price
H190	ARMCHAIR BEDREST (WITH QUILTED PVC COVER)	Each	98.24
H192	SPARE COVER FOR ARMCHAIR BEDREST - QUILTED PVC	Each	39.52

Abduction Pads, Leg Troughs & Supports

Leg Supports H404 - Made from high quality foam. Illustrated here with cotton, PVC and non-woven zip-fastened covers. Typically used to support the lower leg after ankle surgery. The cover is supplied separately from the foam core.

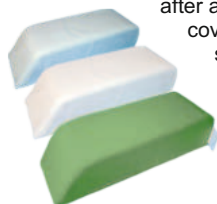

Abduction Pads H200V, H201V, H202V & H203V - Made from high quality foam. Typically used after hip and upper leg surgery with the added advantage of hook and loop retaining straps and replaceable fleece liners. Available in two sizes with a choice of covers.



Leg Trough H206 - High quality foam with a zip-fastened PVC cover, used to support the leg after various types of leg surgery. Also available with a vapour-permeable cover - see H206VP.

Cat No		Pack	Price
H200V	ABDUCTION PAD LARGE COTTON COVERED	Each	44.00
H201V	ABDUCTION PAD SMALL COTTON COVERED	Each	39.42
H202V	ABDUCTION PAD LARGE PVC COVERED	Each	41.89
H203V	ABDUCTION PAD SMALL PVC COVERED	Each	37.66
H204	REPLACEMENT FLEECE LINERS FOR H200V, H201V, H202V & H203V	Pair	5.99
H209	TRIANGULAR ABDUCTION PAD 21x16x6" (53.3x40.6x15.2cm)	Each	54.72
H1812	TRIANGULAR ABDUCTION PAD 18x12x6" (45.7x30.5x15.2cm)	Each	33.03
H404	LEG SUPPORT FOAM CORE	Each	40.71
H404NWC	NON WOVEN VAPOUR-PERMEABLE COVER FOR H404	Each	6.82
H404PVCC	PVC COVER FOR H404	Each	7.94
H404CC	COTTON COVER FOR H404	Each	13.70
H206	LEG TROUGH PVC COVER 25x10x6" (63.5x25.4x15.2cm)	Each	31.05
H206VP	LEG TROUGH VAPOUR-PERMEABLE COVER 25x10x6" (63.5x25.4x15.2cm)	Each	31.50

Triangular Abduction Pads H209 & H1812 - Made from high quality foam. Typically used after hip surgery. Available in 2 sizes with PVC covers.



Trolley Mattress

Made from high density foam, this product is X-ray translucent and comes complete with a zipped-on wipe-clean removable cover. The covers are both waterproof and anti-static, as well as two-way stretchable. The mattress is secured to the trolley using hook and loop tapes. Flame-retardant.

Please call our Customer Care team on 01707 385226 to discuss your requirements. These products are made to order due to the various sizes in use.



We make to order

If you can't see it just give us a call on 01707 385226. We can often make exactly what you need to your own specification.



Section 21 - Heel & Elbow Protectors

Heel Protectors

H400 & H400VP

Hollow-fibre-filled heel support. Choice of cotton or vapour-permeable cover, both with hook and loop fastenings. Designed to lift the foot off the bed to provide maximum pressure relief. Supplied with synthetic fleece liner. Machine-washable or hand-washable and flame-retardant.



H360 & H360VP

Hollow-fibre-filled foot pillow. Choice of cotton or vapour-permeable cover, both with hook and loop fastenings. Machine-washable or hand-washable and flame-retardant.



H212LW

Heel Protector lined with 25mm-pile real lambswool fleece. Padded hook and loop fastening for maximum comfort. Machine-washable or hand-washable.



H240

Heel protector lined with 27mm-pile synthetic fleece. Padded hook and loop fastening for maximum comfort. A cost-effective alternative to real fleece. Machine-washable or hand-washable and flame-retardant.



Elbow Protectors

H252



Elbow protector lined with 27mm-pile synthetic fleece. Padded hook and loop fastening for maximum comfort. Machine-washable or hand-washable and flame-retardant.

H365



Elbow protector lined with 27mm-pile synthetic fleece. Padded hook and loop fastening for maximum comfort. Choice of cotton or vapour-permeable cover. Machine-washable or hand-washable and flame-retardant.

H214LW



Elbow protector lined with 25mm-pile real lambswool fleece. Padded hook and loop fastening for maximum comfort. Machine-washable or hand-washable.

Cat No		Pack	Price
H212LW	REAL LAMBSWOOL HEEL PROTECTOR	Each	11.51
H240	SYNTHETIC FLEECE HEEL PROTECTOR	Each	5.94
H360	FOOT PILLOW WITH COTTON COVER	Each	11.50
H360VP	FOOT PILLOW WITH VAPOUR-PERMEABLE COVER	Each	18.53
H400	ANKLE RING HEEL SUPPORT WITH COTTON COVER	Each	15.32
H400VP	ANKLE RING HEEL SUPPORT WITH VAPOUR-PERMEABLE COVER	Each	23.22
H214LW	REAL LAMBSWOOL ELBOW PROTECTOR	Each	12.73
H252	SYNTHETIC FLEECE ELBOW PROTECTOR	Each	13.70
H365	ELBOW PROTECTOR WITH COTTON COVER	Each	18.27

For Bed Boots & Bootees see our Protective Clothing & Footwear section



Section 22 - Patient Positioners

Devon™ Patient Positioners

Positioning patients properly in the Operating Room is critical to providing the best care possible and protecting against complications such as pressure ulcers and nerve damage. These preventable injuries can be devastating to the patient and have significant consequences. Selecting the appropriate positioning devices for each procedure is a collaborative process for the perioperative registered nurse, surgeon and anaesthesia provider. Designed to aid in proper positioning and pressure distribution, Devon Positioning Products provide a complete offering to help position and protect patients in the Operating Room. These latex-free single-patient-use positioners are made from fire retardant foam in a raspberry swirl colour and are supplied individually vacuum-packed or in convenient box quantities.

Devon™ Prone and Lateral Head Positioning



Slotted Head Positioner
31143160



Frame Head Positioner
31143020



Soft Touch Head Positioner
31163184

Cat No		Pack	Price
31143160S	SLOTTED ADULT HEAD POSITIONER	Each	5.30
31143160	SLOTTED ADULT HEAD POSITIONER	24	127.27
31143020S	FRAME HEAD REST WITH RIGHT SLOT	Each	8.84
31143020	FRAME HEAD REST WITH RIGHT SLOT	28	247.58
31163184S	SOFT TOUCH HEAD POSITIONER	Each	9.65
31163184	SOFT TOUCH HEAD POSITIONER	28	270.09

Devon™ Supine Head Positioning



Whole-in-One Head Rest
31143152



Head Rest 23cm Bagel
31143137

Cat No		Pack	Price
31143152S	WHOLE-IN-ONE POSITIONER 8,10,15,23cm RING	Each	2.35
31143152	WHOLE-IN-ONE POSITIONER 8,10,15,23cm RING	36	84.73
31143137S	BAGEL POSITIONER 23cm RING	Each	2.35
31143137	BAGEL POSITIONER 23cm RING	36	84.73
31143129S	ADULT HEAD POSITIONER	Each	3.53
31143129	ADULT HEAD POSITIONER	24	84.80
31143194S	CHILD HEAD POSITIONER	Each	3.24
31143194	CHILD HEAD POSITIONER	24	77.72

Devon™ Body Positioning

Cat No		Pack	Price
31143103S	OPERATING ROOM TABLE WEDGE	Each	7.07
31143103	OPERATING ROOM TABLE WEDGE	8	56.58
31143392S	BODY ALIGNMENT WEDGE 55x51x22cm	Each	11.79
31143392	BODY ALIGNMENT WEDGE 55x51x22cm	8	94.33
31163457S	CONVOLUTED OPERATING ROOM TABLE PAD 183x51x5cm	Each	14.74
31163457	CONVOLUTED OPERATING ROOM TABLE PAD 183x51x5cm	12	176.89
31143384S	PAIR OF CONVOLUTED UTILITY PADS 41x30x30cm	1 Pair	8.25
31143384	PAIR OF CONVOLUTED UTILITY PADS 41x30x30cm	12 Pairs	98.96
31143418S	CHEST ROLL 43x13cm	Each	5.39
31143418	CHEST ROLL 43x13cm	12	64.65
31143434S	BOLSTER SMALL 46x18cm	Each	7.07
31143434	BOLSTER SMALL 46x18cm	12	84.87
31143442S	BOLSTER LARGE 76x18cm	Each	27.88
31143442	BOLSTER LARGE 76x18cm	10	139.36

OR Table Wedge
31143103



Chest Roll 31143418

Body Alignment Wedge
31143392



Convulated Utility Pad
31143384

Convulated OR Table Pad
31163457

Devon™ Upper Extremity Positioning

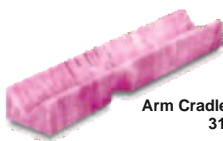

Arm Cradle - Laminectomy
31143491

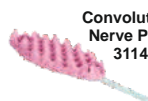

Convulated Ulnar Nerve Protector
31143095

Cat No		Pack	Price
31143095S	CONVOLUTED ULNAR NERVE PROTECTOR 41x15x5cm	Each	2.35
31143095	CONVOLUTED ULNAR NERVE PROTECTOR 41x15x5cm	72	169.46
31143467S	CONVOLUTED ARM BOARD PAD 51x20x5cm	Each	3.34
31143467	CONVOLUTED ARM BOARD PAD 51x20x5cm	24	42.33
31143491S	ARM CRADLE 61x13x8cm	Each	6.48
31143491	ARM CRADLE 61x13x8cm	24	77.72

Devon™ Lower Extremity Positioning



Frog Leg Positioner
31143376



Cradle Positioner
31157988



Arthroscopic Well Leg Holder
31143277



Convulated Foot & Heel Protectors
31143178



Abduction Pillows
31143053
31143061
31143087

Cat No		Pack	Price
31143053S	LARGE ABDUCTION PILLOW 63x46x15cm	Each	21.44
31143053	LARGE ABDUCTION PILLOW 63x46x15cm	6	128.65
31143061S	MEDIUM ABDUCTION PILLOW 56x38x15cm	Each	29.49
31143061	MEDIUM ABDUCTION PILLOW 56x38x15cm	6	176.93
31143087S	SMALL ABDUCTION PILLOW 43x30x15cm	Each	24.39
31143087	SMALL ABDUCTION PILLOW 43x30x15cm	6	146.35
31157988S	CRADLE POSITIONER	Each	21.44
31157988	CRADLE POSITIONER	12	257.30
31143376S	FROG LEG POSITIONER	Each	27.88
31143376	FROG LEG POSITIONER	10	278.84
31143178S	CONVOLUTED FOOT & HEEL PROTECTOR	1 Pair	4.71
31143178	CONVOLUTED FOOT & HEEL PROTECTOR	36 Pairs	169.46
31143277S	ARTHROSCOPIC WELL LEG HOLDER	Each	14.74
31143277	ARTHROSCOPIC WELL LEG HOLDER	18	265.34
31143046S	ARTHROSCOPIC KNEE HOLDER	Each	8.85
31143046	ARTHROSCOPIC KNEE HOLDER	10	88.48



Sani-Cloth® 70% Alcohol Wipes

- Disinfection of medical devices and hard surfaces, including bed frames, counters, wheelchairs, IV poles, non-porous surfaces etc.
- Low-lint wipe impregnated with 70% isopropyl alcohol (IPA).
- Effective bactericidal action (EN1276) against MRSA, E. coli, Pseudomonas Aeruginosa and a diverse range of micro-organisms.

Cat No		Wipes / Pack	Price
PDIP00142	SANI-CLOTH 70 - 130 x 185mm WIPE, CANISTER	125	2.10
PDIP00159	SANI-CLOTH 70 - 200 x 220mm WIPE, CANISTER	200	3.42
PDIP00197	SANI-CLOTH 70 - 130 x 185mm WIPE, CANISTER REFILL PACK	125	1.77
PDIXP00198	SANI-CLOTH 70 - 200 x 220mm WIPE, CANISTER REFILL PACK	200	3.35
PDID24100	SANI-CLOTH 70 - 200 x 128mm, INDIVIDUAL SACHETS	100	4.30
PDIQ53521	HOLDER/BRACKET FOR 200 WIPE CANISTERS	Each	10.68



Bactericidal

Super Sani-Cloth® Plus 70% Alcohol + QUAT Wipes

- Disinfection of medical devices and hard surfaces, including bed frames, counters, wheelchairs, IV poles, non-porous surfaces etc.
- Low-lint wipe impregnated with 70% isopropyl alcohol (IPA) + QUAT**.
- Effective bactericidal action (EN1276) against MRSA, E. coli, Pseudomonas Aeruginosa and a diverse range of micro-organisms. Also provides bactericidal (EN1040), fungicidal (EN1275), virucidal and tuberculocidal disinfection.

Cat No		Wipes / Pack	Price
PDIP00141	SUPER SANI-CLOTH PLUS - 200 x 220mm WIPE, CANISTER	200	4.32
PDIXP00192	SUPER SANI-CLOTH PLUS - 130 x 185mm WIPE, CANISTER	125	1.95
PDIQ53521	HOLDER/BRACKET FOR 200 WIPE CANISTERS	Each	10.68



Bactericidal



Virucidal



Fungicidal



Tuberculocidal

** = n-Alkyl dimethyl ethylbenzyl ammonium chlorides 0.25 %w/w, n-Alkyl dimethyl benzyl ammonium chlorides 0.25 %w/w.

Medipal® 70% Alcohol Wipes

Medipal's Alcohol Wipes are made of Tritex non-woven and contain 70% isopropyl alcohol (IPA). They are the most rigorously tested, effective and proven efficacious alcohol wipe product on the market today.



- Effective against 99.999% of bacteria according to EN standard tests: BS EN 1276, BS EN 13704, BS EN 13727, BS EN 14348, BS EN 14476, BS EN 14561, 3-stage Siani protocol C.diff and MRSA test and BS EN 13697.
- Controlled dosage ensures disinfection every time.
- Tritex technology – strong, low linting – tougher and doesn't produce fibres.
- Medipal Alcohol Wipes are smear-free, leaving no visible residue on glass and stainless steel.

Cat No		Wipes / Pack	Price
W605110MP	MEDIPAL ALCOHOL - 180 x 130mm WIPE, CANISTER	150	1.85
W600110MP	MEDIPAL ALCOHOL - 210 x 195mm WIPE, CANISTER	225	3.17
Q600110MP	MEDIPAL ALCOHOL - 210 x 195mm WIPE, CANISTER REFILL	225	3.43
S610110MP	MEDIPAL ALCOHOL - 200 x 200mm WIPE, FLOW WRAP	50	1.63

Sani-Cloth Active® Alcohol Free Wipes

- Disinfection of alcohol-sensitive areas such as incontinence mattresses, plastic and equipment leadwires.
- Provides bactericidal (EN1040, EN1276, EN13697), fungicidal (EN1275, EN1650), virucidal disinfection (EN14476, Polio, Hepatitis B, Herpes, Norwalk, Adenovirus & Rotavirus, HIV1) and tuberculocidal disinfection.

Cat No		Wipes / Pack	Price
PDIP00188	SANI-CLOTH ACTIVE - 130 x 220mm WIPE, CANISTER	125	2.50
PDIP00190	SANI-CLOTH ACTIVE - 200 x 220mm WIPE, CANISTER	200	4.09
PDIQ53521	HOLDER/BRACKET FOR 200 WIPE CANISTERS	Each	10.68



Bactericidal



Virucidal



Fungicidal



Tuberculocidal

Sani-Cloth Rapid® Alcohol Free Sporocidal Wipes

- Disinfection of non-invasive medical devices, providing a broad spectrum of kill, including spores.
- QUAT**-based, alcohol-free sporocidal wipe which is effective against, bacteria, fungi, viruses, TB, C. difficile and B. subtilis spores. It exceeds EN13704 with a 5 log reduction in 30 minutes.



Cat No		Wipes / Pack	Price
PDIXP00289	SANI-CLOTH RAPID - 300 x 245mm WIPE, BUCKET	225	6.75

** = n-Alkyl dimethyl ethylbenzyl ammonium chlorides 0.25 %w/w, n-Alkyl dimethyl benzyl ammonium chlorides 0.25 %w/w.

Section 23 - Wipes

Medipal® Alcohol-Free Disinfection Wipes

Medipal Alcohol-Free Disinfection Wipes are made of Tritex non-woven and are proven to clean and disinfect in clinical environments. The wipes are the most rigorously tested, effective and proven efficacious disinfectant wipes product on the market today. Medipal Disinfectant Wipes function as both a detergent and disinfectant and are effective on their own or in combination with other products from the Medipal range. Medipal's biocides are uniquely blended to prevent bacterial resistance and superbug formation. Medipal Disinfectant Wipes are proven to kill most microorganisms such as bacteria, fungi, yeasts and viruses. The wipes have been independently tested to a wide range of EN standards.



Cat No		Wipes / Pack	Price
W615110MP	MEDIPAL DISINFECTANT - 190 x 210mm WIPE, CANISTER	225	2.65
W620110MP	MEDIPAL DISINFECTANT - 250 x 280mm HEAVYWEIGHT WIPE, BUCKET	250	7.77
W623110MP	MEDIPAL DISINFECTANT - 250 x 280mm WIPE, BUCKET	300	5.49
W625110MP	MEDIPAL DISINFECTANT - 190 x 200mm WIPE, BUCKET	1000	10.74
W628110MP	MEDIPAL DISINFECTANT - 190 x 200mm HEAVYWEIGHT WIPE, BUCKET	1000	11.15
S621110MP	MEDIPAL DISINFECTANT - 300 x 200mm MACERATABLE WIPE, FLOW WRAP	150	5.03
S624110MP	MEDIPAL DISINFECTANT - 200 x 200mm WIPE, FLOW WRAP	25	0.90
S626110MP	MEDIPAL DISINFECTANT - 200 x 200mm WIPE, FLOW WRAP	50	1.17
S625110MP	MEDIPAL DISINFECTANT - 300 x 200mm WIPE, FLOW WRAP	200	3.20
S627110MP	MEDIPAL DISINFECTANT - 300 x 200mm WIPE, FLOW WRAP	100	1.78

Sani-Cloth Chlor® +1000 Sporidical Wipes

- Effective sporicidal action (EN13704), Sani-Cloth Chlor+1000 demonstrates a log 5 spore kill in 30 seconds in clean conditions and a 4 log reduction in one minute in dirty conditions.
- Ready to use, pre-moistened, pre-measured, broad-spectrum disinfection wipe.
- Meets DOH and HPA guidelines.
- Free colour-coded wall bracket.



- Bactericidal
- Virucidal
- Fungicidal
- Tuberculocidal
- Sporidical

Cat No		Wipes / Pack	Price
PDIXP00297	SANI-CLOTH CHLOR+1000 - 200 x 200mm WIPE, CANISTER	50	5.59

Medipal® Sporidical Wipes

Medipal high level disinfectant wipes are proven to kill most micro organisms. They are highly effective against C.diff spores and are tested to a range of bactericidal, sporicidal, yeasticidal & fungicidal, viruicidal and tuberculocidal EN standards.



Cat No		Wipes / Pack	Price
W663110MP	MEDIPAL SPORICIDAL - 190 x 210mm WIPE, CANISTER	225	4.77
W668110MP	MEDIPAL SPORICIDAL HEAVYWEIGHT - 250 x 280mm WIPE, BUCKET	250	6.48

Sani-Cloth® Detergent Wipes



- Impregnated with a low-level detergent for the cleaning of beds, mattresses and most other surface cleaning applications.
- Reduces the risk of infection caused by reusable cloths and liquids.

Cat No		Wipes / Pack	Price
PDIP00186	SANI-CLOTH DETERGENT - 200 x 300mm WIPE, FLOW WRAP	60	1.69
PDIP00175	SANI-CLOTH DETERGENT - 250 x 300mm WIPE, BUCKET	225	7.00
PDIP00210	SANI-CLOTH DETERGENT - 250 x 300mm WIPE, REFILL PACK	225	4.95

Medipal® Detergent Wipes

Medipal Detergent Wipes are ideal for general cleaning and damp dusting in healthcare environments.



Cat No		Wipes / Pack	Price
W630110MP	MEDIPAL DETERGENT - 190 x 210mm WIPE, CANISTER	225	2.98
Q615110MP	MEDIPAL DETERGENT - 190 x 210mm WIPE, CANISTER REFILL	225	2.26
W635110MP	MEDIPAL DETERGENT - 250 x 280mm HEAVYWEIGHT WIPE, BUCKET	250	5.64
W638110MP	MEDIPAL DETERGENT - 250 x 280mm WIPE, BUCKET	300	5.44
W640110MP	MEDIPAL DETERGENT - 190 x 210mm WIPE, BUCKET	1000	9.92
W643110MP	MEDIPAL DETERGENT - 190 x 300mm HEAVYWEIGHT WIPE, BUCKET	1000	13.16
S635110MP	MEDIPAL DETERGENT - 200 x 300mm WIPE, FLOW WRAP	150	3.67



Sani-Cloth® CHG2% - Chlorhexidine Medical Device Wipes

- As recommended by epic 2 and NICE guidelines for the disinfection of catheter hubs and connection ports.
- Impregnated with 70% isopropyl alcohol (IPA) + 2% chlorhexidine digluconate (CHG).
- Effective bactericidal disinfection.



Cat No	Wipes / Pack	Price
PDIXP00220	SANI-CLOTH CHG 2% - 127 x 178mm, INDIVIDUAL SACHETS	100 4.30

Medipal® Chlorhexidine Wipes & Mitts



Rapid disinfection for critical care, pre-op washes and surfaces. Effective against: MRSA, TB, Norovirus, HIV

- Saturated with 70% ethanol and 2% chlorhexidine digluconate, Medipal Chlorhexidine Wipes and Mitts are ideal for rapid antiseptic body cleaning.
- Single-use sachets remove grime and residue from adhesives and plaster casts.
- Sachets meet recommended epic 2 and NICE guidelines for the disinfection of catheter hubs and connection ports.
- Wipes and Mitts are used for pre-op washes and bed bathing in high dependency areas.
- Medipal's biocides are uniquely blended to prevent bacterial resistance and superbug formation. They conform to biocide regulation 98/8/EC.
- Effective bactericidal disinfection.

Cat No	Wipes / Pack	Price
SSD680110MP	MEDIPAL CHLORHEXIDINE - 190 x 125mm WIPE, INDIVIDUAL SACHETS	200 4.97
W680110MP	MEDIPAL CHLORHEXIDINE - 130 x 180mm WIPE, CANISTER	150 2.80
W685110MP	MEDIPAL CHLORHEXIDINE - 195 x 210mm WIPE, CANISTER	225 4.15
S682110MPCE	MEDIPAL CHLORHEXIDINE - 170 x 240mm PRE-OP MITTS, CANISTER	4 2.02

PDI Prep-Pads

Alcohol prep pad saturated with 70% isopropyl alcohol (IPA). For use as skin preparation prior to injection.

Cat No	Wipes / Pack	Price
PDIXP00110	ALCOHOL PREP PADS/WIPES 60 x 30mm	100 0.99
PDIXPB05505	ALCOHOL PREP PADS/WIPES 60 x 30mm	200 1.60
PDIXP00302	ALCOHOL PREP PADS/WIPES 60 x 30mm	500 4.35



Adhesive Tape Remover

- Effectively removes tape and residue from skin.
- Reduces patient discomfort.
- Contains C11-12 isoparaffin, isopropyl alcohol, petroleum naphtha, isopropyl, palmitate, isopropyl myristate, isopropyl stearate.



Cat No	Wipes / Pack	Price
PDIB16400	ADHESIVE TAPE REMOVER 32 x 66mm	100 5.03

Section 23 - Wipes

Hygea® Hand & Face Wipes



Canister Features

- ✓ Suitable for hands and face.
- ✓ Fragrance-free.
- ✓ Hypoallergenic, paraben and alcohol-free.
- ✓ Dermatologically tested.
- ✓ 185 x 130 mm and 200 x 200 mm wipe.
- ✓ 125 or 200 wipe canisters.

Flow Wrap Features

- ✓ Suitable for hands and face.
- ✓ Interleaved wipes for easy dispensing.
- ✓ Pulp-based, biodegradable and maceratable.
- ✓ Lightly fragranced.
- ✓ Hypoallergenic, paraben and alcohol-free.
- ✓ Dermatologically tested.
- ✓ 175 x 203 mm wipe.

Cat No		Wipes / Pack	Price
PDIP00162	HYGEA HANDS AND FACE - 185 x 130mm WIPE, CANISTER	125	1.44
PDIP00161	HYGEA HANDS AND FACE - 200 x 220mm WIPE, CANISTER	200	3.17
PDIP00164	HYGEA HANDS AND FACE - 200 x 170mm WIPE, FLOW WRAP	24	0.88
PDIP00166	HYGEA HANDS AND FACE - 200 x 170mm WIPE, FLOW WRAP IN FLAT PACK TUB DISPENSER	80	2.52
PDIP00165	HYGEA HANDS AND FACE - 200 x 170mm WIPE, FLOW WRAP/FLAT PACK TUB DISPENSER REFILL PACK	80	1.52

Hygea® BodyCare Wipes



- ✓ Suitable for the entire body.
- ✓ Biodegradable and maceratable.
- ✓ Fragrance-free.
- ✓ Hypoallergenic, paraben and alcohol-free.
- ✓ Dermatologically tested.
- ✓ 200 x 300 mm wipe.

Cat No		Wipes / Pack	Price
PDIP00195	HYGEA BODYCARE - 200 x 300mm WIPE, FLOW WRAP	60	1.65

Medipal Patient Care Wipes & Mitts

Medipal Patient Care Wipes & Mitts contain vitamins B5 and E, aloe vera and added moisturisers.

- Dermatologically tested.
- Reduce the cost of bed bathing – there's no need for bowls, soap and towels.
- Deodorising, cleaning and refreshing.
- No lanolin or parabens.



Cat No		Wipes / Pack	Price
W655110MP	MEDIPAL PATIENT - 200 x 200mm WIPE, CANISTER	200	3.09
S650110MPT	MEDIPAL PATIENT - 200 x 200mm WIPE, FLOW WRAP	100	2.19
S655110MP	MEDIPAL PATIENT - 200 x 200mm MACERATABLE WIPE, FLOW WRAP	80	2.08
S653110MP	MEDIPAL PATIENT - 170 x 240mm FRAGRANCE FREE MITT, FLOW WRAP	8	1.62
S658110MP	MEDIPAL PATIENT - 170 x 240mm FRAGRANCED MITT, FLOW WRAP	8	1.62

Hygea® BodyCare Dry Wipes



Highly absorbent wipe suitable for incontinence.



Large, absorbent cotton-enriched wipe for cleaning heavily soiled skin.

Maceratable 60g

Cotton-soft 46g

Cat No: PDIP00217

Cat No: PDIP00216

Wipe size: 300 x 300mm
Wipe weight: 50g/m²
Wipe per roll: 70 Wipes
Material: 100% Airlaid

Wipe size: 300 x 300mm
Wipe weight: 40g/m²
Wipe per roll: 100 Wipes
Material: 70% Polypropylene
20% Viscose
10% Cotton

Features

- ✓ Unique easy-to-use dispensing system.
- ✓ Sticker allows user to locate first wipe.
- ✓ Handle allows for convenient use and storage.
- ✓ Clear bag for easy identification of remaining wipes.
- ✓ Wipes remain contained within the bag, minimising potential contamination.
- ✓ Wipes are large, absorbent and strong.
- ✓ Roll dispensing system prevents "bunch grabbing" of wipes, thus reducing waste.

Cat No		Wipes / Pack	Price
PDIP00217	HYGEA BODYCARE COTTON MACERATABLE WIPES - 300 x 300mm WIPE, DISPENSER ROLL	70	3.00
PDIP00216	HYGEA BODYCARE COTTON-SOFT DRY WIPES - 300 x 300mm WIPE, DISPENSER ROLL	100	2.98



Section 24 - Bedding Protection

Total Confidence PVC Bedding Protection



Total Confidence is our toughest range of bedding protection products, designed for long term use where maximum protection is required.

A range of styles is available and a number of standard sizes, although we are happy to consider making custom sizes too.

Our Total Confidence material is soft, comfortable and waterproof.

- ✱ Waterproof
- ✱ Machine/hand washable*
- ✱ Mattress protectors
- ✱ Anti dust mite
- ✱ Flame retardant (BS7175, Crib 5&7)
- ✱ Cot sheets
- ✱ Choice of styles
- ✱ Duvet covers
- ✱ Pillow cases
- ✱ Large range of standard sizes
- ✱ Mattress covers
- ✱ Draw sheets

Pillow Cases

Available in a choice of three PVC materials - Anti-Static, Lightweight or Heavy Duty. Choose from a variety of styles. All our Total Confidence Pillow Cases are designed to encase the pillow for total protection.

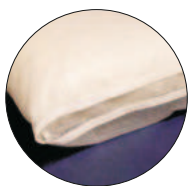

Cat No		Pack	Price
PC1AS	TOTAL CONFIDENCE ANTI STATIC PILLOW CASE 30x20" (76.2x50.8cm) (TUCK-IN FLAP)	Each	6.05
PC1HD	TOTAL CONFIDENCE HEAVY DUTY PILLOW CASE 30x20" (76.2x50.8cm) (TUCK-IN FLAP)	Each	3.88
PC2HD	TOTAL CONFIDENCE HEAVY DUTY PILLOW CASE 30x20" (76.2x50.8cm) (ZIP)	Each	4.14
PC1LW	TOTAL CONFIDENCE LIGHTWEIGHT PILLOW CASE 30x20" (76.2x50.8cm) (TUCK-IN FLAP)	Each	2.70
PC2LW	TOTAL CONFIDENCE LIGHTWEIGHT PILLOW CASE 30x20" (76.2x50.8cm) (ZIP)	Each	2.80
PC5LW	TOTAL CONFIDENCE LIGHTWEIGHT PILLOW CASE 30x20" (76.2x50.8cm) (CAPTIVE FLAP)	Each	2.70
PC650E	TOTAL CONFIDENCE LIGHTWEIGHT PILLOW CASE 30x20" (76.2x50.8cm) BULK PACKED (CAPTIVE FLAP)	50	68.65
PC6LWE	TOTAL CONFIDENCE LIGHTWEIGHT PILLOW CASE 30x20" (76.2x50.8cm) (CAPTIVE FLAP)	Each	1.71
PC7LW	TOTAL CONFIDENCE LIGHTWEIGHT PILLOW CASE 30x20" (76.2x50.8cm) (OPEN END)	Each	1.54

Duvet Covers

Total Confidence Duvet Covers are designed to completely encase the duvet. Produced in Lightweight PVC in various sizes with a choice of zip or tie tape fastenings.

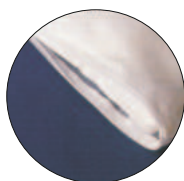

Cat No		Pack	Price
DC1MWK	TOTAL CONFIDENCE DUVET COVER 86x90" (218.4x228.6cm) (TIE TAPES)	Each	55.85
DC1MWD	TOTAL CONFIDENCE DUVET COVER 78x78" (198.1x198.1cm) (TIE TAPES)	Each	25.32
DC1MWS	TOTAL CONFIDENCE DUVET COVER 78x52" (198.1x132.1cm) (TIE TAPES)	Each	11.32
DC2MWK	TOTAL CONFIDENCE DUVET COVER 86x90" (218.4x228.6cm) (ZIP)	Each	58.89
DC2MWD	TOTAL CONFIDENCE DUVET COVER 78x78" (198.1x198.1cm) (ZIP)	Each	25.82
DC2MWS	TOTAL CONFIDENCE DUVET COVER 78x52" (198.1x132.1cm) (ZIP)	Each	12.72

We make to order

If you can't see it just give us a call on 01707 385226. We can often make exactly what you need to your own specification.

* = Do not spin, wring, iron or tumble dry. Do not use fabric conditioners. Allow to dry naturally away from hot pipes or radiators.

Section 24 - Bedding Protection

Total Confidence PVC Bedding Protection

Mattress Covers

Total Confidence Mattress Covers are designed to completely encase the mattress. Produced in Lightweight or Heavy Duty PVC. Total Confidence Mattress Covers can be supplied with either a neat fold-in flap or a zip fastening.

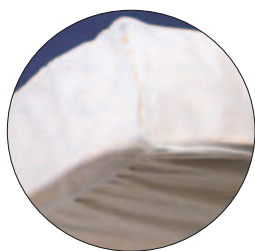

Cat No		Pack	Price
MC1HD24	TOTAL CONFIDENCE HEAVY DUTY MATTRESS COVER 75x24x7" (190.5x61.0x17.8cm) (FLAP)	Each	15.61
MC1HD30	TOTAL CONFIDENCE HEAVY DUTY MATTRESS COVER 75x30x7" (190.5x76.2x17.8cm) (FLAP)	Each	17.25
MC1HD36	TOTAL CONFIDENCE HEAVY DUTY MATTRESS COVER 75x36x7" (190.5x91.4x17.8cm) (FLAP)	Each	17.63
MC1HD42	TOTAL CONFIDENCE HEAVY DUTY MATTRESS COVER 75x42x7" (190.5x106.7x17.8cm) (FLAP)	Each	20.15
MC1HD48	TOTAL CONFIDENCE HEAVY DUTY MATTRESS COVER 75x48x7" (190.5x121.9x17.8cm) (FLAP)	Each	20.52
MC1HD54	TOTAL CONFIDENCE HEAVY DUTY MATTRESS COVER 75x54x7" (190.5x137.2x17.8cm) (FLAP)	Each	22.16
MC1HD60	TOTAL CONFIDENCE HEAVY DUTY MATTRESS COVER 75x60x7" (190.5x152.4x17.8cm) (FLAP)	Each	32.35
MC1LW24	TOTAL CONFIDENCE LIGHTWEIGHT MATTRESS COVER 75x24x7" (190.5x61.0x17.8cm) (FLAP)	Each	9.45
MC1LW30	TOTAL CONFIDENCE LIGHTWEIGHT MATTRESS COVER 75x30x7" (190.5x76.2x17.8cm) (FLAP)	Each	9.95
MC1LW36	TOTAL CONFIDENCE LIGHTWEIGHT MATTRESS COVER 75x36x7" (190.5x91.4x17.8cm) (FLAP)	Each	10.61
MC1LW42	TOTAL CONFIDENCE LIGHTWEIGHT MATTRESS COVER 75x42x7" (190.5x106.7x17.8cm) (FLAP)	Each	11.32
MC1LW48	TOTAL CONFIDENCE LIGHTWEIGHT MATTRESS COVER 75x48x7" (190.5x121.9x17.8cm) (FLAP)	Each	12.03
MC1LW54	TOTAL CONFIDENCE LIGHTWEIGHT MATTRESS COVER 75x54x7" (190.5x137.2x17.8cm) (FLAP)	Each	14.86
MC2HD30	TOTAL CONFIDENCE HEAVY DUTY MATTRESS COVER 75x30x7" (190.5x76.2x17.8cm) (ZIP)	Each	18.01
MC2HD36	TOTAL CONFIDENCE HEAVY DUTY MATTRESS COVER 75x36x7" (190.5x91.4x17.8cm) (ZIP)	Each	18.39
MC2HD36XD	TOTAL CONFIDENCE HEAVY DUTY MATTRESS COVER 75x36x9" (190.5x91.4x22.9cm) (ZIP)	Each	19.14
MC2HD42	TOTAL CONFIDENCE HEAVY DUTY MATTRESS COVER 75x42x7" (190.5x106.7x17.8cm) (ZIP)	Each	21.15
MC2HD48	TOTAL CONFIDENCE HEAVY DUTY MATTRESS COVER 75x48x7" (190.5x121.9x17.8cm) (ZIP)	Each	21.40
MC2HD54	TOTAL CONFIDENCE HEAVY DUTY MATTRESS COVER 75x54x7" (190.5x137.2x17.8cm) (ZIP)	Each	23.43
MC2HD54XD	TOTAL CONFIDENCE HEAVY DUTY MATTRESS COVER 75x54x9" (190.5x137.2x22.9cm) (ZIP)	Each	24.18
MC2HD60	TOTAL CONFIDENCE HEAVY DUTY MATTRESS COVER 75x60x7" (190.5x152.4x17.8cm) (ZIP)	Each	33.50
MC2LW30	TOTAL CONFIDENCE LIGHTWEIGHT MATTRESS COVER 75x30x7" (190.5x76.2x17.8cm) (ZIP)	Each	10.97
MC2LW36	TOTAL CONFIDENCE LIGHTWEIGHT MATTRESS COVER 75x36x7" (190.5x91.4x17.8cm) (ZIP)	Each	11.32
MC2LW36XD	TOTAL CONFIDENCE LIGHTWEIGHT MATTRESS COVER 75x36x9" (190.5x91.4x22.9cm) (ZIP)	Each	12.00
MC2LW42	TOTAL CONFIDENCE LIGHTWEIGHT MATTRESS COVER 75x42x7" (190.5x106.7x17.8cm) (ZIP)	Each	12.60
MC2LW48	TOTAL CONFIDENCE LIGHTWEIGHT MATTRESS COVER 75x48x7" (190.5x121.9x17.8cm) (ZIP)	Each	13.09
MC2LW54	TOTAL CONFIDENCE LIGHTWEIGHT MATTRESS COVER 75x54x7" (190.5x137.2x17.8cm) (ZIP)	Each	16.23
MC2LW54XD	TOTAL CONFIDENCE LIGHTWEIGHT MATTRESS COVER 75x54x9" (190.5x137.2x22.9cm) (ZIP)	Each	16.98

Mattress Protectors

Mattress Protectors are designed to cover the top and sides of a mattress. They are manufactured from Heavy Duty PVC and incorporate a tuck-over end section for securing to the mattress.

Cat No		Pack	Price
MP1HD24	TOTAL CONFIDENCE MATTRESS PROTECTOR 75x24x6" (190.5x61.0x15.2cm)	Each	8.80
MP1HD30	TOTAL CONFIDENCE MATTRESS PROTECTOR 75x30x6" (190.5x76.2x15.2cm)	Each	10.71
MP1HD36	TOTAL CONFIDENCE MATTRESS PROTECTOR 75x36x6" (190.5x91.4x15.2cm)	Each	10.97
MP1HD36XD	TOTAL CONFIDENCE MATTRESS PROTECTOR 75x36x9" (190.5x91.4x22.9cm)	Each	11.72
MP1HD42	TOTAL CONFIDENCE MATTRESS PROTECTOR 75x42x6" (190.5x106.7x15.2cm)	Each	13.60
MP1HD48	TOTAL CONFIDENCE MATTRESS PROTECTOR 75x48x6" (190.5x121.9x15.2cm)	Each	14.87
MP1HD54	TOTAL CONFIDENCE MATTRESS PROTECTOR 75x54x6" (190.5x137.2x15.2cm)	Each	14.98
MP1HD54XD	TOTAL CONFIDENCE MATTRESS PROTECTOR 75x54x9" (190.5x137.2x22.9cm)	Each	15.73
MP1HD60	TOTAL CONFIDENCE MATTRESS PROTECTOR 75x60x6" (190.5x152.4x15.2cm)	Each	25.18
MP1HD60XD	TOTAL CONFIDENCE MATTRESS PROTECTOR 75x60x9" (190.5x152.4x22.9cm)	Each	25.93

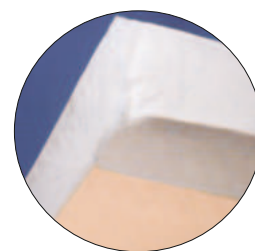

PVC Sheeting by the Roll

PVC Sheeting is available in Anti-Static, Lightweight or Heavy Duty, in a choice of widths and lengths.



Anti-Static

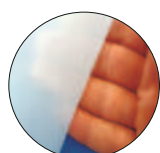

Heavy Duty

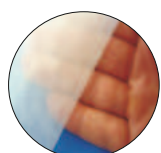

Lightweight

Cat No		Pack	Price
SHMW3610	36" (91.4cm) WIDE LIGHTWEIGHT PVC ON A ROLL	10 Metre Roll	11.59
SHMW3630	36" (91.4cm) WIDE LIGHTWEIGHT PVC ON A ROLL	30 Metre Roll	34.68
SHMW3650	36" (91.4cm) WIDE LIGHTWEIGHT PVC ON A ROLL	50 Metre Roll	57.74
SHAS4810	48" (122cm) WIDE ANTI-STATIC PVC ON A ROLL	10 Metre Roll	57.62
SHAS4830	48" (122cm) WIDE ANTI-STATIC PVC ON A ROLL	30 Metre Roll	172.99
SHAS4850	48" (122cm) WIDE ANTI-STATIC PVC ON A ROLL	50 Metre Roll	287.98
SHHD4810	48" (122cm) WIDE HEAVY DUTY PVC ON A ROLL	10 Metre Roll	31.91
SHHD4830	48" (122cm) WIDE HEAVY DUTY PVC ON A ROLL	30 Metre Roll	95.92
SHHD4850	48" (122cm) WIDE HEAVY DUTY PVC ON A ROLL	50 Metre Roll	159.63

Other sizes available on request.

Draw, Mattress & Cot Sheets

Total Confidence Draw, Mattress and Cot Sheets are designed to protect the most vulnerable parts of the mattress and are available in a range of sizes and materials. Mattress and Cot Sheets are supplied with tie tapes for more secure fastening. DSLW & DSHD have reinforced hemmed edges.

Cat No		Pack	Price
DS50EW	TOTAL CONFIDENCE LIGHTWEIGHT DRAWSHEET 60x 42" (152.4x106.7cm) BULK PACKED	50	93.17
DSLW	TOTAL CONFIDENCE LIGHTWEIGHT DRAWSHEET 60x36" (152.4x91.4cm)	Each	3.13
DSHD	TOTAL CONFIDENCE HEAVY DUTY DRAWSHEET 60x36" (152.4x91.4cm)	Each	4.62
MSLW	TOTAL CONFIDENCE LIGHTWEIGHT MATTRESS SHEET 72x48" (182.9x121.9cm)	Each	5.01
MSHD	TOTAL CONFIDENCE HEAVY DUTY MATTRESS SHEET 72x48" (182.9x121.9cm)	Each	6.99
CSLW	TOTAL CONFIDENCE LIGHTWEIGHT COT SHEET 35x23" (88.9x58.4cm)	Each	3.15
CSDH	TOTAL CONFIDENCE HEAVY DUTY COT SHEET 35x23" (88.9x58.4cm)	Each	8.97



Pretty Confidence Non-Woven Bedding Protection

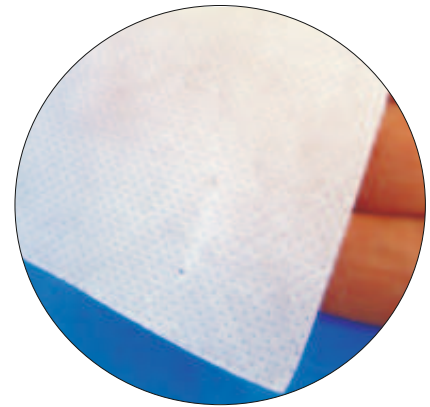

Pretty Confidence is our softest range of bedding protection products, designed for everyday use where lighter protection is required.

The range includes most standard sizes, although we are happy to consider making custom sizes too.

Our Pretty Confidence non-woven material is not only soft, comfortable and splashproof but is also vapour-permeable, allowing air to pass very slowly through microscopic holes too small for liquid, enabling sweat-free sleep.

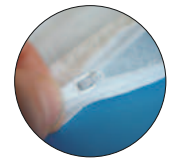

Zip



Tuck in Flap

- * Vapour Permeable
- * Splashproof
- * Breathable
- * Anti Dust Mite
- * Large Range of Standard Sizes
- * Machine/Hand Washable*
- * 50gsm Material
- * Mattress Covers
- * Pillow Cases
- * Duvet Covers

Cat No	Duvet Covers	Pack	Price
DC2NWK	PRETTY CONFIDENCE DUVET COVER 86x90" (218.4x228.6cm) (ZIP)	Each	19.90
DC2NWD	PRETTY CONFIDENCE DUVET COVER 78x78" (198.1x198.1cm) (ZIP)	Each	16.86
DC2NWS	PRETTY CONFIDENCE DUVET COVER 78x52" (198.1x132.1cm) (ZIP)	Each	8.57
Cat No	Mattress Covers	Pack	Price
MC1NW36	PRETTY CONFIDENCE MATTRESS COVER 75x36x7" (190.5x91.4x17.8cm) (FLAP)	Each	12.46
MC1NW54	PRETTY CONFIDENCE MATTRESS COVER 75x54x7" (190.5x137.2x17.8cm) (FLAP)	Each	15.28
MC2NW36	PRETTY CONFIDENCE MATTRESS COVER 75x36x7" (190.5x91.4x17.8cm) (ZIP)	Each	10.35
MC2NW54	PRETTY CONFIDENCE MATTRESS COVER 75x54x7" (190.5x137.2x17.8cm) (ZIP)	Each	14.98
Cat No	Pillow Cases	Pack	Price
PC1NW	PRETTY CONFIDENCE PILLOW CASE 30x20" (76.2x50.8cm) (TUCK IN FLAP)	Each	3.75
PC2NW	PRETTY CONFIDENCE PILLOW CASE 30x20" (76.2x50.8cm) (ZIP)	Each	3.22
PC5NW	PRETTY CONFIDENCE PILLOW CASE 30x20" (76.2x50.8cm) (CAPTIVE FLAP)	Each	5.12

* Do not spin, wring, iron or tumble dry. Do not use fabric conditioners. Allow to dry naturally away from hot pipes or radiators.

We make to order

If you can't see it just give us a call on 01707 385226. We can often make exactly what you need to your own specification.

Section 24 - Bedding Protection

CleanPatch™ - Surface Repair Patch for Hospital Beds and Stretchers



CleanPatch is a first-in-class medical surface repair patch for hospital beds and stretchers that restores damaged mattresses to an intact and hygienic state. Inspired by a nurse and her story, CleanPatch is a cost-effective tool to enhance patient safety.

Clinically Tested - Tested and confirmed by Infection Control Professionals in a healthcare setting:

- Durable: CleanPatch remained fully adhered to mattresses for over one year in a real hospital.
- Cleanable: CleanPatch can be effectively cleaned by hospital disinfectants used during routine and terminal cleaning.
- Equal: CleanPatch did not harbour any more organisms than the mattress it was placed on before and after cleaning.

Cost-savings - Extends the life of mattresses and stretchers reducing direct and indirect cost:

- Annual savings: CleanPatch is 1/20th the cost of a new standard hospital mattress.
- Keeping beds in service: CleanPatch is an immediate repair option to minimize downtime and associated costs.
- Patient Safety: CleanPatch is a cost-effective tool to proactively address damaged and unhygienic surfaces.

Safe and simple - Designed and proven with healthcare stakeholders.

- Biocompatible: CleanPatch is made from medical-grade, Latex-free materials and shown to be non-cytotoxic.
- Easy to apply: CleanPatch is designed to be applied in seconds by Housekeeping, Facilities Management or Nursing.

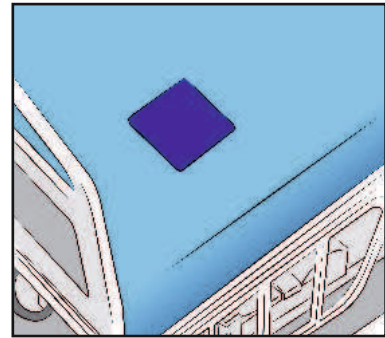
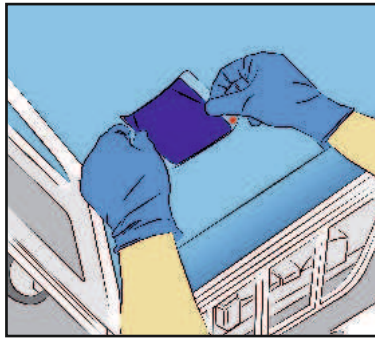
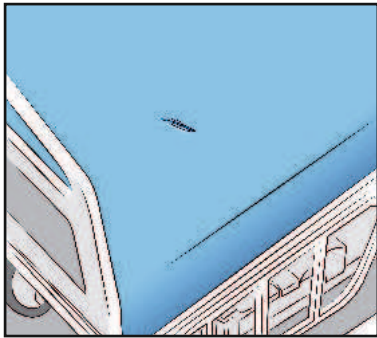

CleanPatch before application



CleanPatch on a mattress



CleanPatch on a stretcher



Cat No		Pack	Price
10001	CLEANPATCH SURFACE REPAIR PATCH 3.5" x 3.5"	20	300.00
10003	CLEANPATCH SURFACE REPAIR PATCH 3.5" x 3.5"	5	95.00
12001	CLEANPATCH SURFACE REPAIR PATCH 3.5" x 6"	10	300.00



PVC Pull-On Pants

Manufactured from waterproof PVC, this semi-disposable pant is both hand-washable and machine-washable at 40°C. Sizes range from 32" - 60" hip. A gusset pocket is included for a pad where appropriate.



Cat No		Pack	Price
IPPO32	PVC INCO PANTS PULL-ON 32" (81.3cm) HIP SIZE	Each	5.15
IPPO34	PVC INCO PANTS PULL-ON 34" (86.4cm) HIP SIZE	Each	5.15
IPPO36	PVC INCO PANTS PULL-ON 36" (91.4cm) HIP SIZE	Each	5.15
IPPO38	PVC INCO PANTS PULL-ON 38" (96.5cm) HIP SIZE	Each	5.25
IPPO40	PVC INCO PANTS PULL-ON 40" (101.6cm) HIP SIZE	Each	5.25
IPPO42	PVC INCO PANTS PULL-ON 42" (106.7cm) HIP SIZE	Each	5.25
IPPO44	PVC INCO PANTS PULL-ON 44" (111.8cm) HIP SIZE	Each	5.25
IPPO46	PVC INCO PANTS PULL-ON 46" (116.8cm) HIP SIZE	Each	5.50
IPPO48	PVC INCO PANTS PULL-ON 48" (121.9cm) HIP SIZE	Each	5.50
IPPO52	PVC INCO PANTS PULL-ON 52" (132.1cm) HIP SIZE	Each	6.20
IPPO56	PVC INCO PANTS PULL-ON 56" (142.2cm) HIP SIZE	Each	6.20
IPPO60	PVC INCO PANTS PULL-ON 60" (152.4cm) HIP SIZE	Each	6.20

Reusable Machine-Washable Fabric Pants

ACTIV Female Mini



Mini Brief with built-in pad is particularly suitable for use during sports or exercise. Pad absorbs up to 120ml.

ACTIV Female Full



Full Brief with built-in pad features the fashionable Activ style but with a fuller design. Pad absorbs up to 120ml.

ACTIV Female Shortie



Shortie Pants with built-in pad are designed to look like normal underwear. Pad absorbs up to 150ml.

READI Female Full



Readi Brief with built-in pad features a stay dry layer to reduce dampness and maintain a fresher feeling. Pad absorbs up to 250ml.

READI Female Pouch



Readi Brief Pouch Pant has an internal pouch for a disposable absorbent pad (not supplied) which can be changed without removing the briefs. A large stay-dry liner reduces dampness to maintain comfort.

READI Male Traditional



Readi Traditional Brief with built-in pad is a full style brief with a traditional appearance, fly opening and a stay-dry layer to maintain a fresher feeling in everyday use. Pad absorbs up to 250ml.

READI Male Brief



Readi Brief with built-in pad has a more contemporary appearance and includes a stay-dry layer. Pad absorbs 250ml of fluid.

READI Male Pouch



Readi Brief Pouch has a stay-dry layer plus a waterproof outer layer, an internal pouch for a disposable absorbent pad (not supplied) which can be changed without removing the briefs.

Cat No	Male	Pack	Price
5352	READI TRAD 100% COTTON 30-32" (76-80cm) HIP SIZE	6	62.05
5353	READI TRAD 100% COTTON 34-36" (86-90cm) HIP SIZE	6	62.05
5354	READI TRAD 100% COTTON 38-40" (97-102cm) HIP SIZE	6	62.05
5355	READI TRAD 100% COTTON 42-44" (107-112cm) HIP SIZE	6	62.05
5356	READI TRAD 100% COTTON 46-48" (117-122cm) HIP SIZE	6	66.40
5357	READI TRAD 100% COTTON 50-52" (127-132cm) HIP SIZE	6	66.40
5358	READI TRAD 100% COTTON 54-56" (137-142cm) HIP SIZE	6	66.40
5625	READI BRIEF 100% COTTON 30-32" (76-80cm) HIP SIZE	6	54.90
5626	READI BRIEF 100% COTTON 34-36" (86-90cm) HIP SIZE	6	54.90
5627	READI BRIEF 100% COTTON 38-40" (97-102cm) HIP SIZE	6	54.90
5628	READI BRIEF 100% COTTON 42-44" (107-112cm) HIP SIZE	6	54.90
5629	READI BRIEF 100% COTTON 46-48" (117-122cm) HIP SIZE	6	54.90
5485	READI POUCH 100% COTTON 30-32" (76-80cm) HIP SIZE	6	51.75
5486	READI POUCH 100% COTTON 34-36" (86-90cm) HIP SIZE	6	51.75
5487	READI POUCH 100% COTTON 38-40" (97-102cm) HIP SIZE	6	51.75
5488	READI POUCH 100% COTTON 42-44" (107-112cm) HIP SIZE	6	51.75

Cat No	Female	Pack	Price
5588	ACTIV MINI COTTON-LYCRA 28-30" (71-76cm) HIP SIZE	6	41.20
5589	ACTIV MINI COTTON-LYCRA 32-34" (80-87cm) HIP SIZE	6	41.20
5590	ACTIV MINI COTTON-LYCRA 36-38" (90-97cm) HIP SIZE	6	41.20
5591	ACTIV MINI COTTON-LYCRA 40-42" (100-107cm) HIP SIZE	6	41.20
5592	ACTIV MINI COTTON-LYCRA 44-46" (110-117cm) HIP SIZE	6	41.20
5594	ACTIV FULL COTTON-LYCRA 32-34" (80-87cm) HIP SIZE	6	43.35
5595	ACTIV FULL COTTON-LYCRA 36-38" (90-97cm) HIP SIZE	6	43.35
5596	ACTIV FULL COTTON-LYCRA 40-42" (100-107cm) HIP SIZE	6	43.35
5597	ACTIV FULL COTTON-LYCRA 44-46" (110-117cm) HIP SIZE	6	43.35
5598	ACTIV FULL COTTON-LYCRA 48-50" (121-127cm) HIP SIZE	6	43.35
5500	ACTIV FULL COTTON-LYCRA 52-54" (132-137cm) HIP SIZE	6	51.90
5501	ACTIV FULL COTTON-LYCRA 56-58" (142-147cm) HIP SIZE	6	51.90
5502	ACTIV FULL COTTON-LYCRA 60-54" (152-162cm) HIP SIZE	6	51.90
5672	ACTIV SHORTIE COTTON-LYCRA 32-34" (80-87cm) HIP SIZE	Each	8.35
5673	ACTIV SHORTIE COTTON-LYCRA 36-38" (90-97cm) HIP SIZE	Each	8.35
5674	ACTIV SHORTIE COTTON-LYCRA 40-42" (100-107cm) HIP SIZE	Each	8.35
5675	ACTIV SHORTIE COTTON-LYCRA 44-46" (110-117cm) HIP SIZE	Each	8.35
5520	READI FULL 100% COTTON 32-34" (80-87cm) HIP SIZE	6	39.25
5521	READI FULL 100% COTTON 36-38" (90-97cm) HIP SIZE	6	39.25
5522	READI FULL 100% COTTON 40-42" (100-107cm) HIP SIZE	6	39.25
5523	READI FULL 100% COTTON 44-46" (110-117cm) HIP SIZE	6	39.25
5524	READI FULL 100% COTTON 48-50" (121-127cm) HIP SIZE	6	48.15
5517	READI FULL 100% COTTON 52-54" (132-137cm) HIP SIZE	6	48.15
5518	READI FULL 100% COTTON 56-58" (142-147cm) HIP SIZE	6	48.15
5525	READI POUCH 100% COTTON 32-34" (80-87cm) HIP SIZE	6	36.85
5526	READI POUCH 100% COTTON 36-38" (90-97cm) HIP SIZE	6	36.85
5527	READI POUCH 100% COTTON 40-42" (100-107cm) HIP SIZE	6	36.85
5528	READI POUCH 100% COTTON 44-46" (110-117cm) HIP SIZE	6	36.85
5536	READI POUCH 100% COTTON 48-50" (121-127cm) HIP SIZE	6	46.75
5537	READI POUCH 100% COTTON 52-54" (132-137cm) HIP SIZE	6	46.75
5570	READI POUCH 100% COTTON 56-60" (142-147cm) HIP SIZE	6	46.75



Section 26 - Bedpans, Urinals & Accessories

Bedpans



BP3



UF2



UFSS1

BP3 - A "perfection" style bedpan. A general use bedpan for patients up to 200kg, it has a 3 litre capacity and includes a handle for easy transportation. This product is manufactured from autoclavable blue polypropylene.

UF2 - A slipper-shaped bedpan with a 1000ml capacity designed with a flat front for easy positioning, particularly where patients are immobile. This product is manufactured from autoclavable green polypropylene.

UFSS1 - A slipper-shaped 1000ml capacity female bedpan with spout and stopper, which allows easier sample collection. This product is manufactured from natural-coloured polyethylene. It can be cleaned in a washer/disinfector where temperatures do not exceed 90°C.

Cat No		Pack	Price
BP3	BEDPAN "PERFECTION" TYPE WITH HANDLE ADULT BLUE POLYPROPYLENE AUTOCLAVABLE	Each	7.65
UF2	FEMALE URINAL SLIPPER SHAPE POLYPROPYLENE WITH HANDLE AUTOCLAVABLE	Each	7.00
UFSS1	BEDPAN FEMALE WITH STOPPER POLYETHYLENE	Each	5.70

Urinals



SP1



UF1000



495PP



UMH20

SP1 - St Peters Boat is a urinal suitable for sample collection, as it includes internal graduations for easy measurement. Made from autoclavable blue polypropylene.

UF1000 - A female urinal suitable for sample collection, as it includes graduations for easy measurement. This product is manufactured from natural-coloured polyethylene. It can be cleaned in a washer/disinfector where temperatures do not exceed 90°C.

495PP - A male urinal with a cap for easy transportation. This product has graduated external marking to its 1000ml capacity and is manufactured from natural-coloured polyethylene. It can be cleaned in a washer/disinfector where temperatures do not exceed 90°C. The 495PP can be used with our non-spill adaptor (**NSA1**), a unique product that incorporates a silicon teat one-way valve designed to help improve patient confidence and prevent spillage in use. Wire holders (**UMH20**), which easily attach to the side of the bed, can also be supplied for this product.

Cat No		Pack	Price
495PP	URINAL MALE 1000ml WITH CAP POLYETHYLENE	Each	2.76
NSA1	NON SPILL ADAPTOR WITH SPARE RUBBER TEAT (FOR 495PP)	Each	6.55
UMH20	MALE URINAL HOLDER PLASTIC COATED WIRE (FOR 495PP)	Each	8.50
SP1	ST PETERS BOAT URINAL BLUE POLYPROPYLENE AUTOCLAVABLE	Each	4.63
UF1000	FEMALE URINAL CYGNET STYLE POLYETHYLENE WITH HANDLE	Each	5.70

Commode Specimen Collector



2400SA - Dover commode specimen collection unit is designed for the collection of urine and stool samples or kidney stones. It has a wide lip and clearly marked gradients. It holds approx 26oz (766ml).

Cat No		Pack	Price
2400SA	DOVER COMMODOE SPECIMEN COLLECTOR 26oz, 769ml	60	110.00

Carebag® Men's Urinal Bag with GelMax®

Using the cost effective, disposable CareBag® Men's Urinal with Super Absorbent GelMax® Pad reduces the risk of contact and environmental contamination. The unique Super Absorbent GelMax® Pad transitions up to 16 oz (450 ml) of urine to gel in seconds. By slowing down the urea decay process and reducing air oxidation, the gel significantly reduces unpleasant odours and decreases the risk of contact exposure.



Cat No		Pack	Price
7733993	CAREBAG MALE URINAL BAG WITH GELMAX, DISPOSABLE	20	12.30

Section 26 - Bedpans, Urinals & Accessories

CareBag® - Bedpan & Commode Liners

The CareBag® absorbent bag is the unique combination of an easy-to-close hermetic bag equipped with a GelMax® Super Absorbent Pad inside.

The active particles in the pad quickly solidify fluids and materials upon contact. Once sealed, the risk of spills, splashes and odours are significantly reduced.

CareBag® Bedpan Liner - Designed to safely collect, transport and dispose of body fluids, the award winning single-use CareBag® Bedpan Liner contains a Super Absorbent GelMax® Pad that turns liquids into a gel within seconds. The patented system helps prevent the spread of potential pathogens, lessening the risk of hospital acquired infection.

CareBag® Commode Liner - The single-use CareBag® Commode Liner with Super Absorbent Pad is designed to safely collect, transport, and dispose of body fluids, thus avoiding unpleasant hand cleaning of the pail. The super absorbent pad turns liquid waste (urine, diarrhea, blood, serous fluid) into a gel within seconds. When used to line the commode, both the user and caregiver are protected from the spread of pathogenic organisms by direct or indirect contact, thus minimising risk of cross infection.



Bedpan Liner Benefits

- Ready-to-use
- Fits all bedpan sizes and shapes
- Convenient and cost-effective
- Strong and easy to use
- Safe and convenient collection, transport and disposal of body fluids
- Minimizes staff exposure to body fluids
- Saves time and costs of handling, cleaning and decontamination of bedpans
- Reduces risks and costs associated with HAI
- Eliminates odours when completely closed

Commode Liner Benefits

- Protects most commode chair pails
- Hygienic, single use product
- Safe and convenient collection, transport and disposal of body fluids
- Reduces risks and costs associated with HAI
- Saves staff time and costs related to cleaning commode pail
- Eliminates the unpleasant task of cleaning commode pails
- Eliminates odours when completely closed
- Recommended for Home Care, Hospitals and Nursing Homes
- Recommended for infectious patients and isolation rooms

Cat No		Pack	Price
7711141	CAREBAG BEDPAN LINER WITH GELMAX, DISPOSABLE	20	13.35
7831738	CAREBAG COMMODE LINER WITH GELMAX, DISPOSABLE	20	12.60

GelMax® - Safe Disposal and Transport of Organic Fluids



The GelMax® range is designed to turn urine and soft materials into a gel, minimising direct and indirect contact. Once converted into a gelatinous substance, the materials are contained and safer for transport and disposal. This helps prevent the spread of pathogenic organisms, minimising risk of cross infection and decreasing cost of waste disposal.

The GelMax® powder is made of crystals with outstanding characteristics. It can absorb and solidify up to 450 times its own weight of fluids and soft materials.

Thanks to its super absorbent crystals, the solidifying process quickly takes place by forming a compact amalgam, whilst slowing down the urea decay process into ammonia, which is the molecule responsible for smells.

This physical isolation reduces the air oxidation of the obtained gelatinous mass and limits the risk of germs spreading.

GelMax® Features & Benefits

- Minimises risk of cross-contamination
- Reduces cost of biologic waste disposal
- Saves time in routine cleaning and decontamination of reusable products
- Prevents personnel exposure to body fluids
- Safe disposal of surgical and laboratory fluids, chemicals, and liquid specimens
- Reduces odours
- Pads absorb and congeal up to 16 oz (450ml) of body fluids
- Powder absorbs up to 65 times its weight of organic liquid. 7 grs of powder absorbs up to 16oz (450ml) of body fluids)
- One pouch (7grs) absorbs and congeals up to 16oz (450ml) of body fluids



Cat No		Pack	Price
9582104	GELMAX SUPER ABSORBENT PADS	25	7.95
9578456	GELMAX SUPER ABSORBENT POWDER, 1lt BOTTLE	Each	29.95
9578410	GELMAX SUPER ABSORBENT SOLUBLE POUCH, 7grs	100	53.35

Section 27 - Instrument Trays

Polypropylene Mesh & Perforated Reusable Instrument Trays

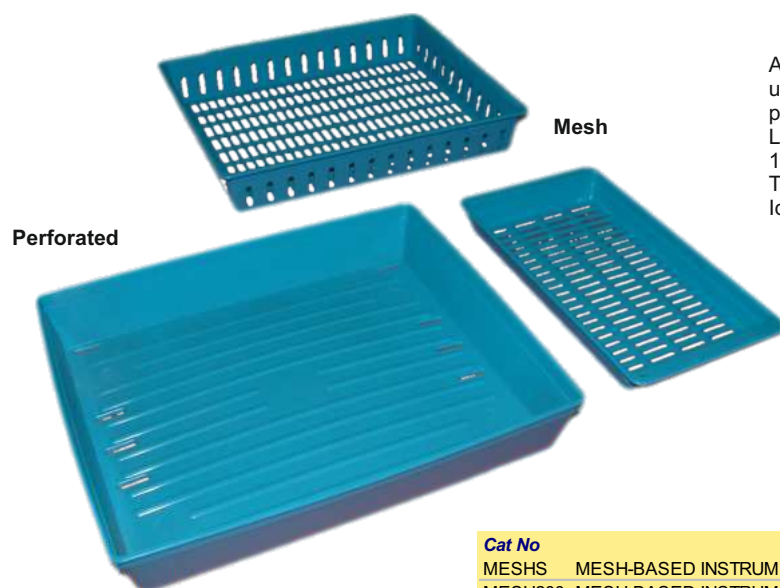

A range of mesh trays is available in various sizes. These are used in high pressure washers. We also offer two sizes of perforated trays.

Lids are available for 200 x 150mm, 270 x 150mm, 280 x 170mm and 300 x 250mm sizes.

These products are manufactured from blue polypropylene. Identification tags can be easily attached to all mesh trays.

Cat No		Pack	Price
MESH5	MESH-BASED INSTRUMENT TRAY 200 x 150 x 51mm	Each	2.95
MESH200	MESH-BASED INSTRUMENT TRAY 200 x 180 x 30mm	Each	2.80
MESHM	MESH-BASED INSTRUMENT TRAY 270 x 150 x 30mm WITH HANDLES	Each	3.40
MESH275	MESH-BASED INSTRUMENT TRAY 275 x 110 x 30mm	Each	2.65
MESH280	MESH-BASED INSTRUMENT TRAY 280 x 170 x 50mm	Each	4.70
MESHL	MESH-BASED INSTRUMENT TRAY 300 x 250 x 52mm WITH MESH SIDES	Each	7.15
MESHXL	MESH-BASED INSTRUMENT TRAY 424 x 305 x 75mm	Each	11.70
PERFL	PERFORATED INSTRUMENT TRAY 300 x 250 x 52mm, 2 x 5 PERFORATIONS	Each	8.10
PERFXL	PERFORATED INSTRUMENT TRAY 424 x 305 x 75mm, 2 x 12 PERFORATIONS	Each	11.75
LID200	LID FOR 200 x 150MM TRAY	Each	2.55
LID270	LID FOR 270 x 150MM TRAY	Each	3.10
LID280	LID FOR 280 x 170MM TRAY	Each	3.20

Polypropylene Solid Reusable Instrument Trays

We offer an extensive range of autoclavable polypropylene instrument trays. These are supplied in various colours including red, yellow, green, blue, purple and natural. We also offer a blue polypropylene lid for the 8 x 6" tray.



Cat No		Pack	Price
IT14103	INSTRUMENT TRAY 381 x 279 x 76mm (15 x 11" x 3"), NATURAL	Each	5.92
IT200B	INSTRUMENT TRAY 200 x 152 x 51mm (8 x 6 x 2"), BLUE	Each	2.71
IT200G	INSTRUMENT TRAY 200 x 152 x 51mm (8 x 6 x 2"), GREEN	Each	2.71
IT200N	INSTRUMENT TRAY 200 x 152 x 51mm (8 x 6 x 2"), NATURAL	Each	2.57
IT200P	INSTRUMENT TRAY 200 x 152 x 51mm (8 x 6 x 2"), PURPLE	Each	2.71
IT200R	INSTRUMENT TRAY 200 x 152 x 51mm (8 x 6 x 2"), RED	Each	2.71
IT200Y	INSTRUMENT TRAY 200 x 152 x 51mm (8 x 6 x 2"), YELLOW	Each	2.71
IT300B	INSTRUMENT TRAY 305 x 254 x 51 (12 x 10 x 2"), BLUE	Each	5.75
IT300G	INSTRUMENT TRAY 305 x 254 x 51 (12 x 10 x 2"), GREEN	Each	5.75
IT300N	INSTRUMENT TRAY 305 x 254 x 51 (12 x 10 x 2"), NATURAL	Each	5.55
IT300P	INSTRUMENT TRAY 305 x 254 x 51 (12 x 10 x 2"), PURPLE	Each	5.75
IT300R	INSTRUMENT TRAY 305 x 254 x 51 (12 x 10 x 2"), RED	Each	5.75
IT300Y	INSTRUMENT TRAY 305 x 254 x 51 (12 x 10 x 2"), YELLOW	Each	5.75
ITL200	LID TO FIT IT200 RANGE OF INSTRUMENT TRAYS, BLUE	Each	1.98
ITL32	INSTRUMENT TRAY & LID 203 x 76 x 51 (8 x 3" x 2"), BLUE	Each	2.72

Our Purple Polypropylene Trays (IT200P & IT300P) are specifically designed to meet the NPSA recommendations for colour standardisation when using medicines for oral, enteral & nasogastric use. IT200P and IT300P are autoclavable.



Silicone Mats for Instrument Trays

Silicone Mats are designed to fit most metal DIN trays as well as many of our polypropylene instrument trays. They have a minimum temperature resistance of -60°C and a maximum of 250°C. The vents increase water immersion and promote rapid drainage. These products can be cleaned for a minimum of 1000 cycles in washer/disinfector machines (compliant with ISO15883) and steam-sterilised in autoclaves (compliant with HTM2010, HTM2030, BS3970 and ISO17665). Various sizes are available, all in pink.

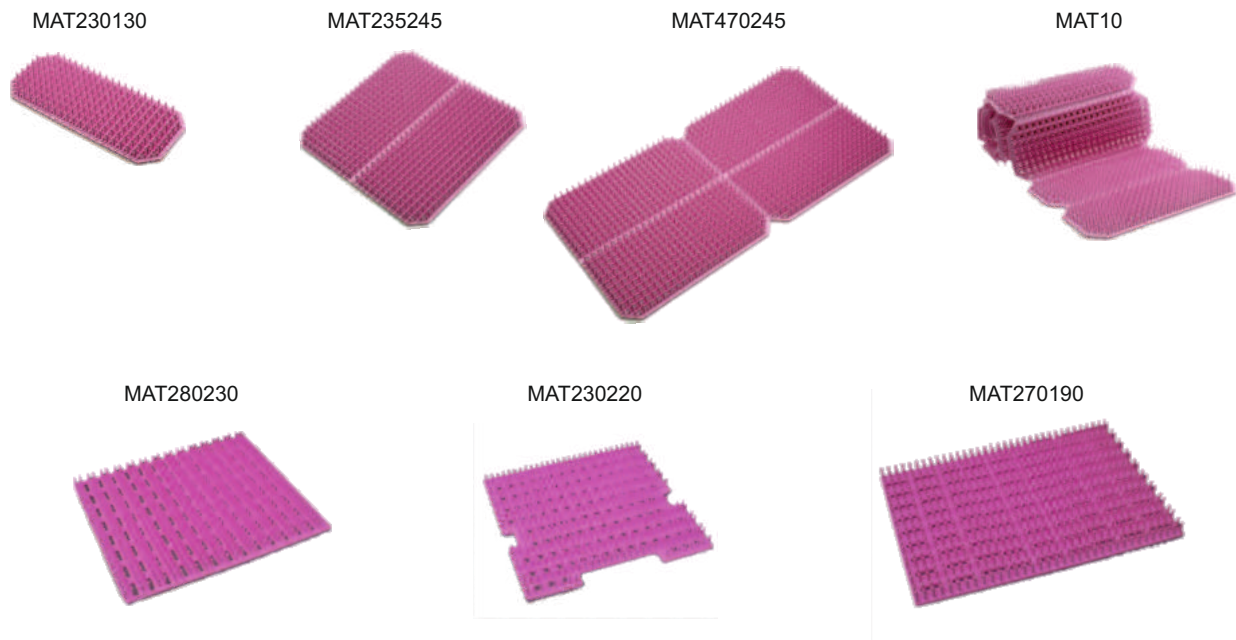

Cat No		Pack	Price
MAT230130	SILICONE MAT 230 x 132mm, FOR MESHM TRAYS AND SMALL METAL DIN TRAYS	Each	9.00
MAT280230	SILICONE MAT 280 x 230mm, FOR MESH, PERFL & IT300 TRAYS	Each	30.50
MAT270190	SILICONE MAT 270 x 190mm, FOR MESHXL, PERFXL TRAYS (HALF TRAY ONLY)	Each	30.00
MAT230220	SILICONE MAT 230 x 220mm, FOR MESHLL (HALF TRAY ONLY)	Each	25.50
MAT235245	SILICONE MAT 235 x 245mm, FOR MEDIUM METAL DIN TRAYS	Each	25.25
MAT470245	SILICONE MAT 470 x 245mm, FOR LARGE METAL DIN TRAYS	Each	49.50
MAT10	SILICONE ROLL 1m LENGTH WITH 10 DIVISIBLE SECTIONS 245 x 100 (X10)mm	Each	109.00

Polypropylene Compartmented Reusable Trays

Compartmented polypropylene basic pack trays are available in yellow, green and blue. The blue tray can be supplied with a tag fixing hole. Tags can be easily attached for identification purposes using either a keyring or cable tie.

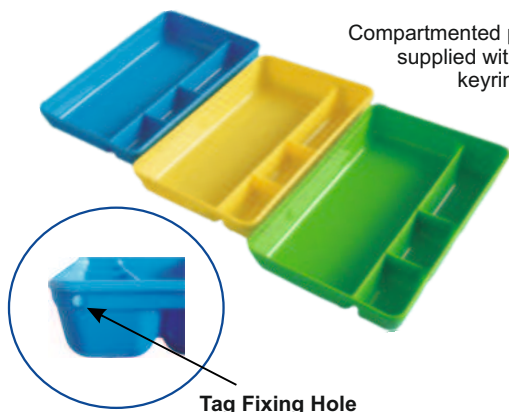

Overall Size	27.0 x 18.0cm
Large Compartment Size	26.4 x 11.8cm
Medium Compartment Size	12.0 x 4.8cm
Small Compartments (Middle)	6.5 x 4.4cm
Small Compartment(Centre)	7.0 x 4.8cm

Cat No		Pack	Price
CIT270B	COMPARTMENTED TRAY BLUE	Each	4.45
CIT270G	COMPARTMENTED TRAY GREEN	Each	4.45
CIT270Y	COMPARTMENTED TRAY YELLOW	Each	4.45
CIT270BH	COMPARTMENTED TRAY BLUE WITH TAG FIXING HOLE	Each	4.45

Identification Tags for Instrument Trays

These tags can be easily attached to most instruments trays for identification purposes. They can be used with all our mesh trays as well the CIT270BH compartmented tray.

Cat No		Pack	Price
TAGWHITE	WHITE IDENTIFICATION TAG FOR USE WITH INSTRUMENT TRAYS	Each	0.40



Section 28 - Bowls, Gallipots & Kidney Dishes

Gallipots



Gallipots are available in a range of colours and sizes. Made from high quality polypropylene, these products are autoclavable.

Cat No	Pack	Price
GP40B	REUSABLE POLYPROPYLENE GALLIPOT 45.4mm 28.4ml BLUE	Each 0.47
GP40N	REUSABLE POLYPROPYLENE GALLIPOT 45.4mm 28.4ml NATURAL	Each 0.44
GP60B	REUSABLE POLYPROPYLENE GALLIPOT 62.4mm 85.2ml BLUE	Each 0.52
GP60G	REUSABLE POLYPROPYLENE GALLIPOT 62.4mm 85.2ml GREEN	Each 0.52
GP60N	REUSABLE POLYPROPYLENE GALLIPOT 62.4mm 85.2ml NATURAL	Each 0.51
GP80B	REUSABLE POLYPROPYLENE GALLIPOT 88.8mm 255.6ml BLUE	Each 0.67
GP80G	REUSABLE POLYPROPYLENE GALLIPOT 88.8mm 255.6ml GREEN	Each 0.67
GP80N	REUSABLE POLYPROPYLENE GALLIPOT 88.8mm 255.6ml NATURAL	Each 0.66

Bowls

Lotion Bowls are available in a range of colours and sizes. Made from high quality polypropylene, these products are autoclavable.

Wash Bowls, unlike Lotion Bowls, have flat bottoms, flat lips and straight sides. They are available in 14" blue or natural polypropylene. Wash Bowls are autoclavable.



Cat No	Pack	Price
LB100N	POLYPROPYLENE LOTION BOWL 4" (101.5mm) 300ml NATURAL	Each 0.66
LB100B	POLYPROPYLENE LOTION BOWL 4" (101.5mm) 300ml BLUE	Each 0.71
LB100G	POLYPROPYLENE LOTION BOWL 4" (101.5mm) 300ml GREEN	Each 0.71
LB100R	POLYPROPYLENE LOTION BOWL 4" (101.5mm) 300ml RED	Each 0.71
LB100Y	POLYPROPYLENE LOTION BOWL 4" (101.5mm) 300ml YELLOW	Each 0.71
LB150N	POLYPROPYLENE LOTION BOWL 6" (152.4mm) 900ml NATURAL	Each 0.98
LB150B	POLYPROPYLENE LOTION BOWL 6" (152.4mm) 900ml BLUE	Each 1.05
LB150G	POLYPROPYLENE LOTION BOWL 6" (152.4mm) 900ml GREEN	Each 1.05
LB150R	POLYPROPYLENE LOTION BOWL 6" (152.4mm) 900ml RED	Each 1.05
LB150Y	POLYPROPYLENE LOTION BOWL 6" (152.4mm) 900ml YELLOW	Each 1.05
LB200N	POLYPROPYLENE LOTION BOWL 8" (203.2mm) 2200ml NATURAL	Each 1.65
LB200B	POLYPROPYLENE LOTION BOWL 8" (203.2mm) 2200ml BLUE	Each 1.68
LB200G	POLYPROPYLENE LOTION BOWL 8" (203.2mm) 2200ml GREEN	Each 1.68
LB200R	POLYPROPYLENE LOTION BOWL 8" (203.2mm) 2200ml RED	Each 1.68
LB200Y	POLYPROPYLENE LOTION BOWL 8" (203.2mm) 2200ml YELLOW	Each 1.68
LB250	POLYPROPYLENE LOTION BOWL 10" (254mm) 3800ml BLUE	Each 2.66
WB350N	POLYPROPYLENE WASHBOWL 14" (356mm) - 6000ml NATURAL	Each 3.80
WB350B	POLYPROPYLENE WASHBOWL 14" (356mm) - 6000ml BLUE	Each 3.80

Kidney Dishes

Cat No	Pack	Price
006PPB	REUSABLE POLYPROPYLENE KIDNEY DISH 6" (152.4mm) BLUE	Each 0.75
006PPG	REUSABLE POLYPROPYLENE KIDNEY DISH 6" (152.4mm) GREEN	Each 0.75
006PPN	REUSABLE POLYPROPYLENE KIDNEY DISH 6" (152.4mm) NATURAL	Each 0.73
006PPY	REUSABLE POLYPROPYLENE KIDNEY DISH 6" (152.4mm) YELLOW	Each 0.75
KD150	REUSABLE POLYPROPYLENE KIDNEY DISH 6" (152.4mm) BLUE	Each 0.80
KD200B	REUSABLE POLYPROPYLENE KIDNEY DISH 8" (203.2mm) BLUE	Each 1.01
KD200G	REUSABLE POLYPROPYLENE KIDNEY DISH 8" (203.2mm) GREEN	Each 1.01
KD200N	REUSABLE POLYPROPYLENE KIDNEY DISH 8" (203.2mm) NATURAL	Each 0.97
KD200R	REUSABLE POLYPROPYLENE KIDNEY DISH 8" (203.2mm) RED	Each 1.01
KD200Y	REUSABLE POLYPROPYLENE KIDNEY DISH 8" (203.2mm) YELLOW	Each 1.01
KD250B	REUSABLE POLYPROPYLENE KIDNEY DISH 10" (254mm) BLUE	Each 1.25
KD250G	REUSABLE POLYPROPYLENE KIDNEY DISH 10" (254mm) GREEN	Each 1.25
KD250N	REUSABLE POLYPROPYLENE KIDNEY DISH 10" (254mm) NATURAL	Each 1.20
KD250R	REUSABLE POLYPROPYLENE KIDNEY DISH 10" (254mm) RED	Each 1.25
KD250Y	REUSABLE POLYPROPYLENE KIDNEY DISH 10" (254mm) YELLOW	Each 1.25
182PPB	REUSABLE POLYPROPYLENE KIDNEY DISH 10" (254mm) WITH HANDLE BLUE	Each 1.30
KD300	REUSABLE POLYPROPYLENE KIDNEY DISH 12" (304.8mm) BLUE	Each 2.35

Kidney Dishes are available in a range of colours and sizes and are made from reusable polypropylene. We can also supply 10" blue polypropylene dishes with handles. These products are autoclavable.



Section 29 - Containers

Screw-Cap Containers

We boast a massive range of screw cap containers. These can be purchased complete with lids which can be supplied with or without wadding. We also supply the lids and containers separately. Wadding helps to improve the seal, thus increasing user confidence. Wadding is typically made from steran card but expanded polythene is also used in some lids. Our range includes tamper-evident containers - once the lid is applied a simple seal must be broken before the lid can be removed. All our screw cap containers are manufactured from FDA approved polypropylene. You may also wish to take advantage of our mini packs, which allow for smaller purchases or better balance of jars and lids.



Screw Cap Range

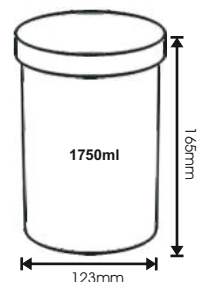
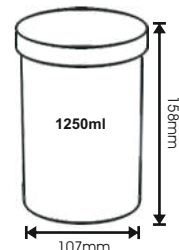
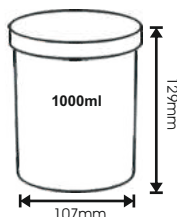
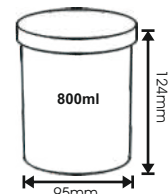
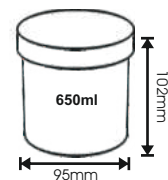
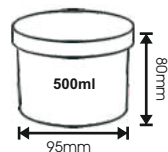
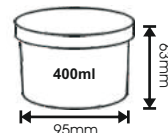
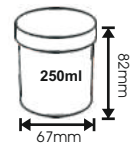

Cat No		Pack	Price			
SCC27	SCREW-CAP CONTAINERS 150ml - WHITE WITH WADDED LIDS	100	31.05			
SCC27N	SCREW-CAP CONTAINERS 150ml - NATURAL WITH UNWADDED LIDS	100	26.75			
SCC28	SCREW-CAP CONTAINERS 250ml - WHITE WITH WADDED LIDS	70	26.25			
SCC28N	SCREW-CAP CONTAINERS 250ml - NATURAL WITH UNWADDED LIDS	70	24.30			
SCC29	SCREW-CAP CONTAINERS 400ml - WHITE WITH WADDED LIDS	60	43.80			
SCC29N	SCREW-CAP CONTAINERS 400ml - NATURAL WITH UNWADDED LIDS	60	37.35			
SCC30	SCREW-CAP CONTAINERS 500ml - WHITE WITH WADDED LIDS	40	26.60			
SCC30N	SCREW-CAP CONTAINERS 500ml - NATURAL WITH UNWADDED LIDS	40	26.15			
SCC31	SCREW-CAP CONTAINERS 650ml - WHITE WITH WADDED LIDS	40	33.85			
SCC33	SCREW-CAP CONTAINERS 800ml - WHITE WITH WADDED LIDS	30	27.35			
SCC34	SCREW-CAP CONTAINERS 1000ml - WHITE WITH WADDED LIDS	30	33.25			
SCC35	SCREW-CAP CONTAINERS 1250ml - WHITE WITH WADDED LIDS	24	31.50			
SCC35N	SCREW-CAP CONTAINERS 1250ml - NATURAL WITH WHITE UNWADDED LIDS	24	31.05			
Cat No		Pack	Price	4+	6+	8+
SCJ150N	SCREW-CAP CONTAINERS ONLY 150ml - NATURAL	288	34.76	32.02	30.68	28.01
SCJ150W	SCREW-CAP CONTAINERS ONLY 150ml - WHITE	288	35.92	33.18	31.73	28.24
SCJ250N	SCREW-CAP CONTAINERS ONLY 250ml - NATURAL	192	31.25	29.48	27.82	24.49
SCJ250W	SCREW-CAP CONTAINERS ONLY 250ml - WHITE	192	32.92	31.36	29.64	25.32
SCW70L	WHITE UNWADDED LIDS FOR 150ml & 250ml CONTAINERS	720	69.29	65.21	56.16	
SCW70LM	WHITE UNWADDED LIDS FOR 150ml & 250ml CONTAINERS (MINI PACK)	120	13.50			
SCW70LWAD	WHITE WADDED LIDS WITH STERAN CARD FOR 150ml & 250ml CONTAINERS	720	98.51	92.86	84.48	
SCW70LWADM	WHITE WADDED LIDS WITH STERAN CARD FOR 150ml & 250ml CONTAINERS (MINI PACK)	120	18.65			
SCN70L	NATURAL UNWADDED LIDS FOR 150ml & 250ml CONTAINERS	720	69.29	65.21	56.16	
SCN70LM	NATURAL UNWADDED LIDS FOR 150ml & 250ml CONTAINERS (MINI PACK)	120	12.95			
SCJ400N	SCREW-CAP CONTAINERS ONLY 400ml - NATURAL	300	105.14	87.14		
SCJ400W	SCREW-CAP CONTAINERS ONLY 400ml - WHITE	300	115.28	92.38		
SCJ500N	SCREW-CAP CONTAINERS ONLY 500ml - NATURAL	240	92.98	87.27	73.27	
SCJ500W	SCREW-CAP CONTAINERS ONLY 500ml - WHITE	240	96.63	91.04	78.63	
SCJ650W	SCREW-CAP CONTAINERS ONLY 650ml - WHITE	180	96.62	91.88	72.28	
SCJ800W	SCREW-CAP CONTAINERS ONLY 800ml - WHITE (TALL)	150	84.53	80.71	76.94	61.46
Cat No		Pack	Price	2+	3+	
SCW100L	WHITE UNWADDED LIDS FOR 400ml, 500ml, 650ml & 800ml CONTAINERS	375	61.07	56.21	49.10	
SCW100LM	WHITE UNWADDED LIDS FOR 400ml, 500ml, 650ml & 800ml CONTAINERS (MINI PACK)	80	14.80			
SCW100LWAD	WHITE WADDED LIDS WITH STERAN CARD FOR 400ml, 500ml, 650ml & 800ml CONTAINERS	375	80.16	74.81	67.39	
SCW100LWADM	WHITE WADDED LIDS WITH STERAN CARD FOR 400ml, 500ml, 650ml & 800ml CONTAINERS (MINI PACK)	80	19.35			
SCN100L	NATURAL UNWADDED LIDS FOR 400ml, 500ml, 650ml & 800ml CONTAINERS	375	58.34	53.59	47.28	
SCN100LM	NATURAL UNWADDED LIDS FOR 400ml, 500ml, 650ml & 800ml CONTAINERS (MINI PACK)	80	14.65			
Cat No		Pack	Price	4+	11+	15+
SCJ1000WP	SCREW-CAP CONTAINERS ONLY 1000ml - WHITE	120	79.77	75.61	65.78	57.15
SCJ1250NP	SCREW-CAP CONTAINERS ONLY 1250ml - NATURAL	80	67.96	64.84	60.22	49.76
SCJ1250WP	SCREW-CAP CONTAINERS ONLY 1250ml - WHITE	96	67.96	64.84	60.22	49.76
Cat No		Pack	Price	3+	5+	
SCW115L	WHITE UNWADDED LIDS FOR 1000ml & 1250ml CONTAINERS	240	63.37	58.47	51.23	
SCW115LM	WHITE UNWADDED LIDS FOR 1000ml & 1250ml CONTAINERS (MINI PACK)	80	21.65			
SCW115LWAD	WHITE WADDED LIDS WITH STERAN CARD FOR 1000ml & 1250ml CONTAINERS	240	86.54	80.40	69.95	
SCW115LWADM	WHITE WADDED LIDS WITH STERAN CARD FOR 1000ml & 1250ml CONTAINERS (MINI PACK)	80	30.25			
SCW115LEPE	EXPANDED POLYETHYLENE WADDED LID FOR 1000ml & 1250ml CONTAINERS	240	88.50	82.55	72.00	
Cat No		Pack	Price	4+	11+	15+
SCJ1750W	SCREW-CAP CONTAINERS ONLY 1750ml - WHITE	60	52.50	51.42	48.06	37.54
Cat No		Pack	Price	3+	5+	
SCW126L	WHITE UNWADDED LIDS FOR 1750ml CONTAINERS	200	113.33	91.16	74.38	
SCW126LEPE	WHITE EXPANDED POLYETHYLENE WADDED LID FOR 1750ml CONTAINERS	200	131.00	120.00	101.00	
Cat No		Pack	Price			
TEJ150	TAMPER-EVIDENT SCREW-CAP CONTAINERS 150ml - WHITE	252	39.50			
TEJ250	TAMPER-EVIDENT SCREW-CAP CONTAINERS 250ml - WHITE	160	29.05			
TEJ500	TAMPER-EVIDENT SCREW-CAP CONTAINERS 500ml - WHITE	180	49.16			
TEL63	WHITE UNWADDED LIDS FOR 150ml TAMPER EVIDENT CONTAINERS	1000	139.71			
TEL80	WHITE UNWADDED LIDS FOR 250ml TAMPER EVIDENT CONTAINERS	640	102.94			
TEL95	WHITE UNWADDED LIDS FOR 500ml TAMPER EVIDENT CONTAINERS	360	75.90			
CJ250	SCREW-CAP CREAM JAR 250ml - WHITE	360	53.53			
CL104	WHITE UNWADDED LIDS FOR 250ml CREAM JAR	360	45.28			

Tamper Evident Seal



Tamper Evident Screw Cap Range

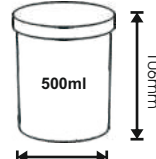
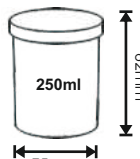
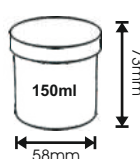

Section 29 - Containers

Snap-Lid Containers

Manufactured from a durable polypropylene and available in three colours, these containers are suitable for most pharmaceutical applications. Supplied complete with lids.



Cat No		Pack	Price
HDC15	ALEXAPOT CONTAINERS 15ml - BROWN	250	28.87
HDC15N	ALEXAPOT CONTAINERS 15ml - NATURAL	250	28.32
HDC15W	ALEXAPOT CONTAINERS 15ml - WHITE	250	28.92
HDC25	ALEXAPOT CONTAINERS 25ml - BROWN	200	28.00
HDC25N	ALEXAPOT CONTAINERS 25ml - NATURAL	200	27.56
HDC25W	ALEXAPOT CONTAINERS 25ml - WHITE	200	28.00
HDC50	ALEXAPOT CONTAINERS 50ml - BROWN	100	17.89
HDC50N	ALEXAPOT CONTAINERS 50ml - NATURAL	100	17.45
HDC50W	ALEXAPOT CONTAINERS 50ml - WHITE	100	17.89
HDC100	ALEXAPOT CONTAINERS 100ml - BROWN	50	13.08
HDC100N	ALEXAPOT CONTAINERS 100ml - NATURAL	50	12.88
HDC100W	ALEXAPOT CONTAINERS 100ml - WHITE	50	13.10
HDC250	ALEXAPOT CONTAINERS 250ml - BROWN	50	26.64
HDC250N	ALEXAPOT CONTAINERS 250ml - NATURAL	50	26.09
HDC250W	ALEXAPOT CONTAINERS 250ml - WHITE	50	26.37

Clear Plastic Boxes

Manufactured from 1mm clear polystyrene and available in various shapes and sizes, with internal partitions for most types. Tight-fitting push-over lids allow solid stacking without slippage. The clear design makes these containers ideal for storage/presentation and/or displaying contents. Partition details are available on request.

Cat No		Pack	Price
12820B	RECTANGULAR BOX 122 X 82 X 22mm	Each	0.67
12830B	RECTANGULAR BOX 122 X 82 X 32mm	Each	0.80
12850B	RECTANGULAR BOX 122 X 82 X 52mm	Each	0.99
128LID	LID FOR RECTANGULAR BOX 122 X 82mm	Each	0.51
8650B	RECTANGULAR BOX 80 X 59 X 49mm	Each	0.75
8650LID	LID FOR RECTANGULAR BOX 80 X 59mm	Each	0.34
A460B	RECTANGULAR BOX 310 X 225 X 60mm	Each	6.19
A4LID	LID FOR RECTANGULAR BOX 310 X 225mm	Each	4.47
A540B	RECTANGULAR BOX 224 X 175 X 40mm	Each	3.55
A560B	RECTANGULAR BOX 224 X 175 X 60mm	Each	3.97
A5LID	LID FOR RECTANGULAR BOX 225 X 175mm	Each	2.47
A640B	RECTANGULAR BOX 175 X 112 X 40mm	Each	2.10
A660B	RECTANGULAR BOX 175 X 112 X 60mm	Each	2.74
A6LID	LID FOR RECTANGULAR BOX 175 X 112mm	Each	1.55



Plastic Tubes



Manufactured from clear polystyrene with polythene stoppers. Available in two sizes. The BT21B is particularly suitable as a transport container for dental crowns.

Cat No		Pack	Price
BT21B	ALEXAPACK CONTAINERS 6ml - WITH WHITE SCREW CAP STOPPER	100	8.85
BT30	ALEXAPACK CONTAINERS 30ml - WITH WHITE SCREW CAP STOPPER	100	17.40

Denture Container

DENT1 - Made from white polypropylene, this denture container is virtually unbreakable. Suitable for both upper and lower dentures. Supplied with a lid which is clearly marked with the word "DENTURES".

Cat No		Pack	Price
DENT1	DENTURE CONTAINER 250ml - REUSABLE	50	24.46



Medicine Measures

Three types of medicine measure are available. The disposable UMP range is available in five colours, all 30ml capacity with 1ml minor graduations and 5ml major graduations. UMP measures are supplied 80 to a polythene sleeve, 60 sleeves per carton. A dispenser and lids are available for the UMP range. The 440PPM, an autoclavable measure with 5ml graduations to 30ml and 10ml graduations from 30ml to its 60ml capacity, is supplied in boxes of 25. 460TPX is a tougher TPX plastic clear measure which is easy to see through and autoclavable. It is supplied in boxes of 100. 460TPX is graduated every 10ml up to its 60ml capacity.

<i>Cat No</i>		<i>Pack</i>	<i>Price</i>	<i>16+</i>	<i>64+</i>
440PPM	HENLEY MEDICINE MEASURE 50/60ml	25	2.94	2.67	2.36
<i>Cat No</i>		<i>Pack</i>	<i>Price</i>	<i>10+</i>	
460TPX	MEDICINE MEASURE 60ml TPX (CLEAR)	100	28.92	26.15	
UMP1	DISPOSABLE MEDICINE MEASURE 30ml - NATURAL	4800	61.70	58.25	
UMP1R	DISPOSABLE MEDICINE MEASURE 30ml - RED	4800	61.70	58.25	
UMP1B	DISPOSABLE MEDICINE MEASURE 30ml - BLUE	4800	61.70	58.25	
UMP1Y	DISPOSABLE MEDICINE MEASURE 30ml - YELLOW	4800	61.70	58.25	
UMP1G	DISPOSABLE MEDICINE MEASURE 30ml - GREEN	4800	61.70	58.25	
UMP2	LID FOR 30ml MEDICINE MEASURE - WHITE	4000	59.15		
300450	DISPENSER FOR UMP MEDICINE MEASURES	Each	22.40		



Our UMP1 medicine measure is available in a choice of colours.

Ondula Ampoule Boxes

Designed for safe storage and transit of glass ampoules. The outer casing is made from impact-resistant cardboard. Inner dividers hold each ampoule in place and prevent them from coming into contact with each other.



<i>Cat No</i>		<i>Pack</i>	<i>Price</i>
OB1	ONDULA AMPOULE BOX 5 X 1ml	50	43.95
OB2	ONDULA AMPOULE BOX 5 X 2ml	50	45.50
OB3	ONDULA AMPOULE BOX 5 X 5ml	50	49.75
OB4	ONDULA AMPOULE BOX 5 X 10ml	50	63.50
OB5	ONDULA AMPOULE BOX 10 X 1ml	50	54.50
OB6	ONDULA AMPOULE BOX 10 X 2ml	50	60.20
OB7	ONDULA AMPOULE BOX 10 X 5ml	50	69.75

Dispensing Spoon

Manufactured from natural polypropylene, our 5ml dispensing spoon is supplied in packs of 250. This product is designed to be self-standing and meets the British Standard.



<i>Cat No</i>		<i>Pack</i>	<i>Price</i>	<i>10+</i>	<i>50+</i>
DS5	DISPENSING SPOON 5ml	250	3.88	3.60	3.36

Tablet Dispensing Bag



HTB - The Henleys Tablet Bag is a small resealable bag used for dispensing tablets.

<i>Cat No</i>		<i>Pack</i>	<i>Price</i>	<i>10+</i>
HTB	TABLET BAGS 2x3.25" (51x83mm)	1000	12.04	10.58

Section 31 - Funnels & Jugs

Funnels

Our funnels are manufactured from high quality polypropylene. Two sizes are available, 6" and 4" diameter. Designed with a fluted funnel and a smooth straight stem, these products are autoclavable.



Cat No		Pack	Price
F100	FUNNEL 4" DIAMETER STRAIGHT STEM NATURAL	Each	0.88
F150	FUNNEL 6" DIAMETER STRAIGHT STEM NATURAL	Each	1.58

Measuring Jugs



Tapered reusable polypropylene measuring jugs available in 500ml and 1000ml sizes. **JG500PP** is a tapered polypropylene jug with a handle. It includes moulded graduations every 5 fl.oz (1/4 Pint) and every 50ml to its full 500ml capacity. **JG1000PP** is a tapered polypropylene jug with a handle. It includes moulded graduations every 10 fl.oz (1/2 Pint) and every 50ml to 800ml, then 100ml graduations to its full 1000ml capacity. These polypropylene jugs are autoclavable to 135 degrees. They are dishwasher-safe and microwave-safe.

Large, clearly marked reusable polypropylene measuring jug available in 2200ml. **593PP** is a straight polypropylene jug with a handle. It includes printed blue graduations for maximum clarity, every 5fl.oz (1/4 Pint) and 100ml to its full 2200ml capacity. This polypropylene jug is autoclavable to 135 degrees and is dishwasher-safe.



Cat No		Pack	Price	100+
JG500PP	POLYPROPYLENE TAPERED MEASURING JUG 500ml (1 PINT), REUSABLE	Each	1.75	1.60
JG1000PP	POLYPROPYLENE TAPERED MEASURING JUG 1000ml (2 PINT), REUSABLE	Each	2.30	2.15
593PP	POLYPROPYLENE CLEAR MARKED MEASURING JUG 2200ml (3.85 PINT), REUSABLE	Each	5.95	



Plain Resealable Bags



RSB1 - RSB7 are produced from 160g polythene, RSB8 - RSB17 and RSBA4 are produced from 180g polythene, HGB bags are produced from 350g polythene. The resealable top makes these products suitable for literally hundreds of applications.

Cat No		Pack	Price	10+
RSB1	RESEALABLE BAGS 2.25x2.25" (57x57mm)	2000	8.33	7.84
RSB2	RESEALABLE BAGS 2.25x3" (57x76mm)	1000	4.80	4.68
RSB3	RESEALABLE BAGS 3x3.25" (76x83mm)	1000	5.96	5.53
RSB4	RESEALABLE BAGS 3.5x4.5" (89x114mm)	1000	7.47	7.11
RSB5	RESEALABLE BAGS 4.5x4.5" (114x114mm)	1000	9.18	8.69
RSB6	RESEALABLE BAGS 4x5.5" (102x140mm)	1000	9.42	8.87
RSB7	RESEALABLE BAGS 5.5x5.5" (140x140mm)	1000	11.52	10.90
RSB8	RESEALABLE BAGS 3x7.5" (76x191mm)	1000	8.55	8.15
RSB9	RESEALABLE BAGS 5x7.5" (127x191mm)	1000	13.50	12.86
RSB10	RESEALABLE BAGS 7.5x7.5" (191x191mm)	1000	19.22	18.58
RSB11	RESEALABLE BAGS 6x9" (152x229mm)	1000	19.05	18.29
RSB12	RESEALABLE BAGS 8x11" (203x279mm)	1000	28.75	27.64
RSB13	RESEALABLE BAGS 12.75x12.75" (324x324mm)	500	25.89	25.18
RSB14	RESEALABLE BAGS 10x14" (254x356mm)	500	23.26	22.44
RSB15	RESEALABLE BAGS 11x16" (279x406mm)	500	27.05	26.41
RSB16	RESEALABLE BAGS 13x18" (330x457mm)	500	35.41	34.59
RSB17	RESEALABLE BAGS 15x20" (381x508mm)	500	44.47	43.24
RSBA4	RESEALABLE BAGS 9x12.75" (229x324mm)	500	19.17	18.46
HGB20	RESEALABLE BAGS HEAVY DUTY 5x8" (127x203mm)	1000	21.96	21.19
HGB30	RESEALABLE BAGS HEAVY DUTY 7x10" (178x254mm)	500	18.52	17.82
HGB40	RESEALABLE BAGS HEAVY DUTY 8x12" (203x305mm)	500	24.40	23.67
HGB50	RESEALABLE BAGS HEAVY DUTY 9x14" (229x356mm)	500	33.83	32.72
HGB60	RESEALABLE BAGS HEAVY DUTY 12x16" (305x406mm)	500	44.84	42.90
HGB70	RESEALABLE BAGS HEAVY DUTY 10x18" (254x457mm)	500	42.91	40.67

Write-On Resealable Bags



RSB120 - RSB126 are produced from 160g polythene, RSB127 - RSB133 are produced from 180g polythene. The write-on panel provides ample space for information. Conveniently placed in the centre of the bag, virtually any pen can be used to mark the bag for easy identification of contents. For our range of marker pens see page 98.

Cat No		Pack	Price	10+
RSB120	WRITE-ON BAGS 2.25x2.25" (57x57mm)	2000	8.53	8.08
RSB122	WRITE-ON BAGS 3x3.25" (76x83mm)	1000	6.68	6.38
RSB123	WRITE-ON BAGS 3.5x4.5" (89x114mm)	1000	8.51	8.14
RSB124	WRITE-ON BAGS 4.5x4.5" (114x114mm)	1000	10.14	9.42
RSB125	WRITE-ON BAGS 4x5.5" (102x140mm)	1000	11.18	10.63
RSB126	WRITE-ON BAGS 5.5x5.5" (140x140mm)	1000	13.07	12.41
RSB127	WRITE-ON BAGS 3x7.5" (76x191mm)	1000	9.29	8.79
RSB128	WRITE-ON BAGS 5x7.5" (127x191mm)	1000	15.72	15.19
RSB129	WRITE-ON BAGS 7.5x7.5" (191x191mm)	1000	19.98	19.11
RSB130	WRITE-ON BAGS 6x9" (152x229mm)	1000	21.27	20.51
RSB131	WRITE-ON BAGS 8x11" (203x279mm)	1000	30.15	29.22
RSB132	WRITE-ON BAGS 9x12.75" (229x324mm)	1000	35.70	34.30
RSB133	WRITE-ON BAGS 10x14" (254x356mm)	1000	43.06	41.78

Printed Resealable Bags (TO YOUR OWN SPECIFICATIONS)

We are able to produce printed bags to virtually any specifications. The example illustrated is our dual-text Welsh/English pharmacy dispensing bag. Please feel free to call our Customer Care team on 01707 385226 for details. A minimum quantity may apply.

Cat No		Pack	Price
ETPB2	ENGLISH TEXT PHARMACY BAGS 6 X 9" (152x229mm)	1000	19.76
ETPB3	ENGLISH TEXT PHARMACY BAGS 8 X 11" (203x279mm)	1000	30.22
DTPB1	DUAL WELSH/ENGLISH TEXT PHARMACY BAGS 5.5 X 5.5" (140x140mm)	1000	28.52
DTPB2	DUAL WELSH/ENGLISH TEXT PHARMACY BAGS 6 X 9" (152x229mm)	1000	29.13
DTPB3	DUAL WELSH/ENGLISH TEXT PHARMACY BAGS 8 X 11" (203x279mm)	1000	46.98
DTPB4	DUAL WELSH/ENGLISH TEXT PHARMACY BAGS 11 X 16" (279x406mm)	500	38.89



Specimen & Biohazard Bags

We stock a wide range of biohazard and specimen bags. Specimen bags are manufactured from a high grade 200g polythene. The specimens are isolated in the resealable section of the bag. Side welded to each of our specimen bags is a document pocket which typically is used to hold a report card.

Biohazard bags are much the same as specimen bags but include a biohazard warning on the resealable section of the bag, which clearly identifies the contents as hazardous. Biohazard bags also incorporate a document pocket.



Cat No		Pack	Price	20+
HB50	SPECIMEN 5x5.5" (127x140mm), POCKET 5x8" (127x203mm)	1000	18.75	18.05
HB55	SPECIMEN 5.5x5.5" (140x140mm), POCKET 5.5x8" (140x203mm)	1000	16.00	15.00
HB55B	BIOHAZARD 5.5x5.5" (140x140mm), POCKET 5.5x8" (140x203mm)	1000	30.74	29.57
HB60	SPECIMEN 6x5.5" (152x140mm), POCKET 6x8" (152x203mm)	1000	23.55	22.79
HB60B	BIOHAZARD 6x5.5" (152x140mm), POCKET 6x8" (152x203mm)	1000	37.40	32.49

Section 33 - Labels

Hospicode® Medilabel Colour-Coded Labelling System

Induction Agents Propofol mg/ml	Tranquillizers Midazolam mg/ml	Tranquillizer Antagonists Flumazenil micrograms/ml	Non Depolarizing Muscle Relaxants Atracurium mg/ml
Depolarizing Muscle Relaxants Suxamethonium mg/ml	Muscle Relaxant Reversal Agents Neostigmine mg/ml	Opiates Fentanyl micrograms/ml	Opiate Antagonists Naloxone micrograms/ml
Local Anaesthetics Lidocaine %	Vasopressors Dobutamine mg/ml	Vasopressors Adrenaline micrograms/ml	Hypotensive Agents Glyceryl Trinitrate mg/ml
Anti-Cholinergic Agents Atropine mg/ml	Anti-Emetics Ondansetron mg/ml	Miscellaneous Drugs Actrapid Insulin units/ml	Miscellaneous Antagonist Agents Protamine mg/ml



As part of the Department of Health's drive to minimise drug administration errors in critical care areas, the Councils of the Royal College of Anaesthetists, the Association of Anaesthetists of Great Britain and Ireland, the Faculty of Accident and Emergency Medicine and the Intensive Care Society agreed to recommend the adoption of a single standard for syringe labelling.

The Hospicode® Medilabel Colour-Coded Syringe Labelling System is totally compliant with the above recommendations. Groups of drugs are easily identified by colour and the Hospicode® Medilabel System is also supplied in colour-coded boxes for even easier, safer and more convenient use.

In addition to syringe labels Henleys are also able to supply longer labels (ideal for I.V. lines) and larger labels (ideal for I.V. bags or syringe drivers).

Line Labels are designed to allow intravenous lines to be easily recognised. The left side of the label is the same as the Hospicode® syringe label showing drug name. The right side of the label also shows the drug name but has space for date and time, so every aspect of administration is accounted for.

Drug Additive Labels are a larger label designed for I.V. bags. These show the drug name and also allow space for amount, added to, concentration, time, date, patient's name, prepared by, batch no and checked by.

We stock over 500 drug titles, each supplied in a convenient colour-coded dispensing box. Also available are transparent wall holders and stand-alone containers.



Cat No		Pack	Price
SLS???	ALL MEDILABEL SYRINGE LABELS 1 1/2" x 1/2"	400	4.24
LL???	ALL MEDILABEL LINE LABELS 3" x 1/2"	200	4.30
DAL???	ALL MEDILABEL DRUG ADDITIVE LABELS 3" x 2"	200	4.00
SLSWALL	WALL RACK HOLDS 11 ROLLS	Each	19.00
SLSTRAY1	CLEAR PERSPEX SYRINGE AND/OR LINE LABEL HOLDER, HOLDS 10 ROLLS	Each	11.20
SLSTRAY2	CLEAR PERSPEX SYRINGE AND/OR LINE LABEL HOLDER, HOLDS 20 ROLLS	Each	18.45
SSDL??	STERILE STRIPS OF UPTO 18 VARIOUS SLS LABELS	250	340.00

We can also supply syringe labels in sterile form - strips containing up to 18 Medilabels of your choice. Please call our Customer Care Team on 01707 385226 to discuss your requirements.

An order form with a complete list of Medilabels is available on request.

Self-Adhesive Labels



Top quality self-adhesive labels produced to your own specifications and design, using the 'Hot-Foil' printing process. This produces labels with great impact, consistently high colour density, high definition and excellent fade resistance. For those difficult applications, the labels can be laminated with a clear high gloss polyester film. This renders the label waterproof, scuff resistant, easy to clean and virtually indestructible. We can also produce multicolour labels, metallic labels and round labels. Most sizes of our labels are supplied rolled into convenient dispensing boxes. Please call our Customer Care Team on 01707 385226 to discuss your requirement.

Permanent Adhesive Colour Labels are available in black, white, light blue, dark blue, orange, light green, dark green, pink, buff, brown, fluorescent tangerine, red and yellow.

Peelable Labels are normally only available in white. Please call our Customer Care Team on 01707 385226 for details of other colour options.

Text colours available are, black, white, light blue, dark blue, light green, dark green, light brown, dark brown, pink, orange, yellow, grey, purple, maroon and buff.

Metallic Labels are produce a wide range of metallic labels. Please call our Customer Care Team on 01707 385226 to discuss your requirements.

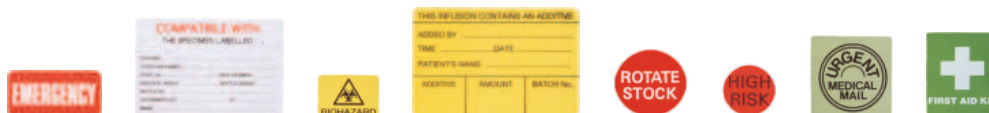

Section 34 - Enema Products

Barium Enema Products

The Henley traditional style barium enema catheters and air insufflators are designed for either single or double contrast studies. All items are entirely latex-free, with cuffs on the retention catheters being produced from silicone to avoid any potential latex allergy risk.

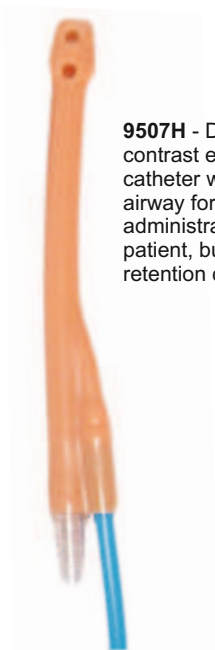

9507H - Double contrast enema catheter with integral airway for air administration to the patient, but without retention cuff.

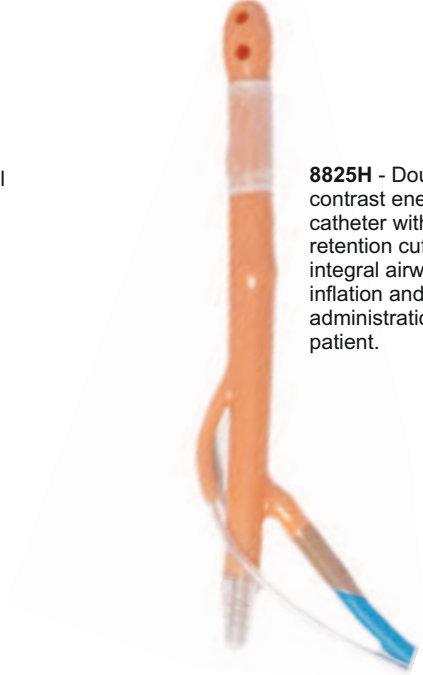

8825H - Double contrast enema catheter with silicone retention cuff and integral airways for cuff inflation and air administration to the patient.



9509H - Double contrast enema catheter with extra large olive and integral airway for air administration to the patient, but without retention cuff.



9529H - Pre-measured insufflator for retention cuff inflation to the correct size.

9525H - Insufflator for use with double contrast catheters for administering air to the patient.

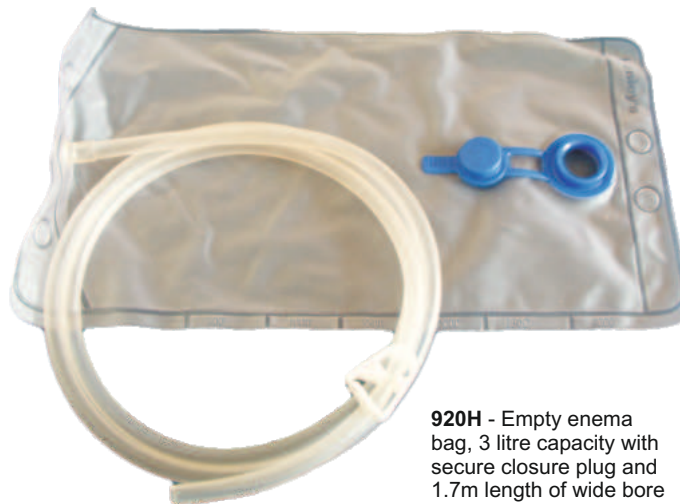

920H - Empty enema bag, 3 litre capacity with secure closure plug and 1.7m length of wide bore tubing with flow control clamp.



820H - Plastic inflatable barium enema spillage ring.

Cat No		Pack	Price
820H	HENLEY BARIUM ENEMA RING	Each	8.25
8825H	HENLEY ENEMA TIP, CUFF AND TUBE	12	50.15
9507H	HENLEY ENEMA TIP WITH TUBE	12	23.25
9509H	HENLEY ENEMA TIP EXTRA LARGE WITH TUBE	12	27.20
920H	HENLEY EMPTY BARIUM ENEMA KIT	Each	5.05
9525H	HENLEY RUBBER INSUFFLATOR	Each	3.50
9529H	HENLEY PRE-MEASURED INSUFFLATOR	Each	2.71



Section 35 - TENS

TENS Unit

Maxtens features a wide array of output combinations to help get the setting "just right". With timers ranging from 15 to 30 and continuous mode, users can choose the settings that are right for them. Maxtens also features three modes: B(Burst), N(Normal) and M(Modulation). The pulse rate, pulse width and amplitude are also fully adjustable.

Maxtens is supplied complete with a convenient hard plastic carry case, housing the unit itself as well as all its accessories including battery, leadwires, electrodes and instructions.

MAX1000 is covered by a full 12-month warranty.



Channel: Dual, isolated between channels
 Amplitude: 0 - 80mA
 Pulse Rate: 1 - 150Hz
 Timer(mins): 15, 30 & Continuous
 Mode: Burst, Modulation, Normal
 Power: DC 9v Battery

Cat No	Pack	Price
MAX1000	MAXTENS 1000 ANALOGUE TENS UNIT COMPLETE	Each 24.99

TENS Self Adhesive Pre-Wired Pigtail Electrodes

PROTEN are cost-effective TENS electrodes with excellent adhesion qualities and a soft cloth construction.

Superior Silver® Starburst electrodes incorporate a patented multi-layer gradient pattern for the most advanced current distribution available and a thick hypoallergenic hydrogel formulated with pure aloe vera, known for its hydrating properties.

Superior Silver®, with extra-thick blue **POLYHESIVE™**, is a good choice for patients with sensitive skin. The conductive silver layer provides uniform current distribution and reusability. They have a soft foam construction.

Re-Ply® electrodes are a cost-effective solution without silver. They have a tricot construction.



Superior Silver Starburst

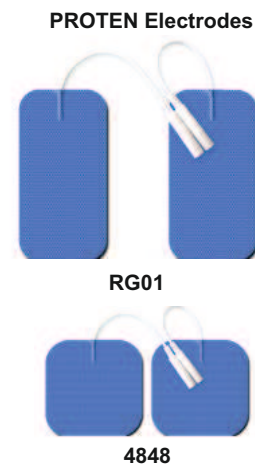

PROTEN Electrodes

Superior Silver with Polyhesive



Re-Ply Electrode



Cat No	Pack	Price
RG01	REUSABLE CLOTH PROTEN ELECTRODE 4 x 2" (100 x 50mm)	4 3.00
4848	REUSABLE CLOTH PROTEN ELECTRODE 2 x 2" (50 x 50mm)	4 3.00
616SB	REUSABLE CLOTH SUPERIOR SILVER STARBURST ELECTRODE 2 x 2" (50 x 50mm)	4 6.85
617SB	REUSABLE CLOTH SUPERIOR SILVER STARBURST ELECTRODE 2 x 4" (50 x 100mm)	4 9.55
627SB	REUSABLE CLOTH SUPERIOR SILVER STARBURST ELECTRODE 2" (50mm) DIAMETER	4 6.85
628SB	REUSABLE CLOTH SUPERIOR SILVER STARBURST ELECTRODE 2 3/4" (70mm) DIAMETER	4 9.55
696S	REUSABLE FOAM SUPERIOR SILVER POLYHESIVE BLUE GEL ELECTRODE 2 x 2" (50 x 50mm)	4 8.90
654	REUSABLE TRICOT RE-PLY ELECTRODE 2 x 2" (50 x 50mm)	4 3.35



TENS Non-Wired Electrodes

Re-Flex® reusable self-adhesive pre-gelled electrodes provide good adhesion to stressed application sites. They have a carbon construction.

Re-Flex Tantone® reusable self-adhesive pre-gelled electrodes have a low profile design with a covered side-pin connection. They have a tricot construction.

Carbon Electrodes reusable non-adhesive carbon electrodes require the use of a conductive gel or conductive gel pad such as Cleartac™.

Cleartac™ reusable self-adhesive conductive gel pads are used for fixing non-adhesive Carbon Electrodes.

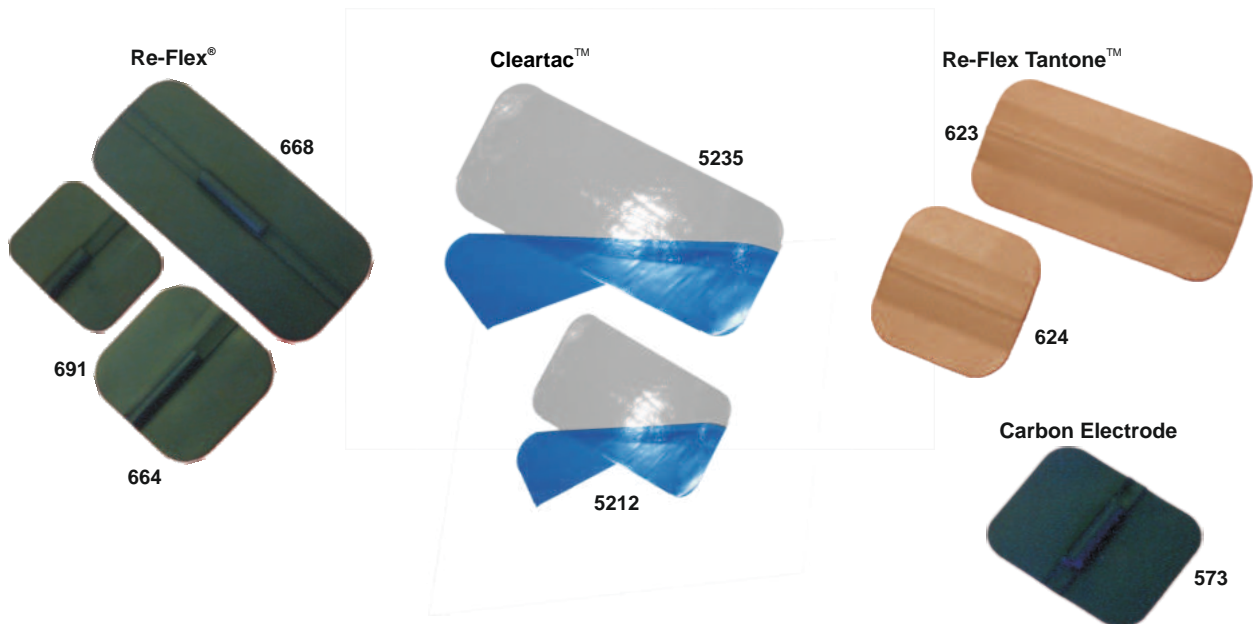

Cat No		Pack	Price
664	REUSABLE SELF-ADHESIVE CARBON RE-FLEX ELECTRODE 2 x 2" (50 x 50mm)	4	5.15
668	REUSABLE SELF-ADHESIVE CARBON RE-FLEX ELECTRODE 1 3/4 x 4" (44 x 100mm)	4	6.45
691	REUSABLE SELF-ADHESIVE CARBON RE-FLEX ELECTRODE 1 1/2 x 1 3/4" (38 x 44mm)	4	3.90
623	REUSABLE SELF-ADHESIVE REFLEX TANTONE ELECTRODE 2 x 4" (50 x 100mm)	4	7.05
624	REUSABLE SELF-ADHESIVE REFLEX TANTONE ELECTRODE 2 x 2" (50 x 50mm)	4	5.15
573	REUSABLE NON-ADHESIVE CARBON ELECTRODE 1 1/2 x 1 3/4" (38 x 44mm)	4	1.95
5212	CLEARTAC ADHESIVE GEL PADS 1 1/2 x 1 3/4" (38 x 44mm)	20	6.90
5235	CLEARTAC ADHESIVE GEL PADS 1 3/4 x 4" (44 x 100mm)	8	7.05

TENS Leadwires



Cat No		Pack	Price
SK43	TENS LEADWIRE (SHROUDED PIN)	Each	4.20
MAXWIRE	TENS LEADWIRE FOR MAXTENS UNITS	Each	3.00

TENS Gels

TENS gels provide a stable conductive layer between the patient's skin and the electrodes. This can reduce patient discomfort whilst maintaining improved response from the unit.

Cat No		Pack	Price	6+	12+
HM37	TENSIVE GEL 50g TUBES	12	50.00	48.15	47.05



Section 36 - Stainless Steel Instruments

Stainless Steel Instruments

A large range of popular stainless steel instruments is available, including scissors, forceps, specula & needle holders. Our stainless steel instruments are autoclavable and most are sold individually.

Tough Cut Scissors make light work of even the strongest material. Designed for maximum comfort and strength.



Cat No	Scissors	Pack	Price
E10701	DISSECTING SCISSORS CLOSED SHANKS 105mm	Each	1.06
N80102	DRESSING SCISSORS BL/BL 125mm	Each	1.29
N80104	DRESSING SCISSORS BL/BL 140mm	Each	1.76
N80401	DRESSING SCISSORS BL/BL CURVED 125mm	Each	1.46
N80202	DRESSING SCISSORS BL/SH 125mm	Each	1.29
N80302	DRESSING SCISSORS SH/SH 125mm	Each	1.29
N80304	DRESSING SCISSORS SH/SH 140mm	Each	1.76
N80305	DRESSING SCISSORS SH/SH 180mm	Each	2.54
B0703001	TOUGH CUT SCISSORS WITH PROTECTOR POINT 180mm	Each	2.75
Cat No	Forceps	Pack	Price
N25201	DISSECTING FORCEPS T.O.E. BLUNT ENDS 125mm	Each	1.07
N25401	GILLIES FORCEPS 1-2TTH 140mm	Each	2.18
N507B1	HALSTEAD MOSQUITO FORCEPS, CURVED, BOX JOINT 125mm	Each	2.67
N506B1	HALSTEAD MOSQUITO FORCEPS, STRAIGHT, BOX JOINT 125mm	Each	2.57
N26401	HUNTERS SPLINTER FORCEPS 115mm	Each	1.76
N26501	MARTINS SPLINTER FORCEPS 75mm	Each	1.46
N574B2	MAYO-HEGARS NEEDLE HOLDER, BOX JOINT 150mm	Each	2.94
N25701	MCINDOES FORCEPS 140mm	Each	1.95
N585B2	RAMPLEYS SPONGE HOLDING FORCEPS 240mm	Each	6.66
N581B1	SINUS FORCEPS B/J 125mm	Each	2.47
N518B1	SPENCER WELLS ARTERY FORCEPS B/J 125mm	Each	2.47
N518B4	SPENCER WELLS ARTERY FORCEPS B/J 200mm	Each	4.50
N519B1	SPENCER WELLS ARTERY FORCEPS B/J CVD 125mm	Each	2.57
N26201	TREVES FORCEP 1-2TTH 125mm	Each	1.23
Cat No	Other Products	Pack	Price
782015	AURAL SYRINGE WITH 2 TIPS 4oz	Each	21.78
N70002	CUSCO SPECULUM MEDIUM	Each	5.39
N70003	CUSCO SPECULUM LARGE	Each	5.39
N70001	CUSCO SPECULUM SMALL	Each	5.39
N70000	CUSCO SPECULUM VIRGIN	Each	5.39
N578B1	KILNERS NEEDLE HOLDER SERRATED B/J 125mm	Each	2.64
N96201	NOOTS EAR TANK	Each	7.75
165305	PROBE WITH EYE SILVER NICKEL 125mm	20	15.95
178825	RING CUTTER COMPLETE WITH BLADE 180mm	Each	34.35
178850	SPARE BLADES FOR RING CUTTER	Each	5.39
N96401	TUNING FORK GARDINER BROWN 128DV	Each	6.99
N96101	UMBILICAL CORD CLAMP CUTTER	Each	5.25
N88201	UMBILICAL SCISSORS 100mm (4")	Each	2.45

Instrument Marking Tape

Uniquely pliable Time Instromark Tape is self-adhesive and produced in eight colours to mark instruments for fast accurate sorting or to identify ownership at a glance.

The plastic tape is 3/8" (9.5mm) wide, has a self-adhesive backing and moulds easily to any surface - rounded, angular or plain. A light touch of the fingertip secures the tape in position for months. It is not affected by scrubbing solutions and does not dry out or become brittle, even after repeated autoclaving. Its lightweight design means it will not affect the weight of the products or create obstruction during use. Roll lengths are approx 200" (508cm).



Cat No		Pack	Price
IN6001	WHITE	Roll	6.10
IN60018	BLACK	Roll	6.10
IN60019	BROWN	Roll	6.10
IN6002	YELLOW	Roll	6.10
IN6003	GREEN	Roll	6.10
IN6005	RED	Roll	6.10
IN6006	ORANGE	Roll	6.10
IN6007	BLUE	Roll	6.10



Section 37 - Tubing Connectors & Accessories

Straight Connectors

Cat No		O.D.	Translucent	Connection		Price
				Type	Pack	
AC1	STRAIGHT CONNECTOR	4.0mm - 6.0mm	Yes	TAPERED	50	8.99
AC1BP	STRAIGHT CONNECTOR BULK PACKED	4.0mm - 6.0mm	Yes	TAPERED	100	15.75
AC1S	STRAIGHT CONNECTOR STERILE	4.0mm - 6.0mm	Yes	TAPERED	50	20.85
AC5	STRAIGHT CONNECTOR	7.0mm - 11.0mm	Yes	TAPERED	50	11.99
AC5BP	STRAIGHT CONNECTOR BULK PACKED	7.0mm - 11.0mm	Yes	TAPERED	100	21.10
AC5S	STRAIGHT CONNECTOR STERILE	7.0mm - 11.0mm	Yes	TAPERED	50	24.90
AC7	STRAIGHT CONNECTOR	10.0mm - 13.0mm	Yes	TAPERED	50	14.59
AC7BP	STRAIGHT CONNECTOR BULK PACKED	10.0mm - 13.0mm	Yes	TAPERED	100	19.70
AC7S	STRAIGHT CONNECTOR STERILE	10.0mm - 13.0mm	Yes	TAPERED	50	28.10
KAR70510	STRAIGHT CONNECTOR	3.0mm - 5.5mm	No	TAPERED	10	4.30
KAR510	STRAIGHT CONNECTOR BULK PACKED	3.0mm - 5.5mm	No	TAPERED	100	35.23
KAR70511	STRAIGHT CONNECTOR	4.5mm - 8.2mm	No	TAPERED	10	4.77
KAR511	STRAIGHT CONNECTOR BULK PACKED	4.5mm - 8.2mm	No	TAPERED	100	40.73
KAR70512	STRAIGHT CONNECTOR	6.3mm - 11.0mm	No	TAPERED	10	6.69
KAR512	STRAIGHT CONNECTOR BULK PACKED	6.3mm - 11.0mm	No	TAPERED	100	54.98
KAR70513	STRAIGHT CONNECTOR	8.3mm - 13.0mm	No	TAPERED	10	7.41
KAR513	STRAIGHT CONNECTOR BULK PACKED	8.3mm - 13.0mm	No	TAPERED	100	61.09
KAR70514	STRAIGHT CONNECTOR	10.0mm - 15.0mm	No	TAPERED	10	8.35
KAR514	STRAIGHT CONNECTOR BULK PACKED	10.0mm - 15.0mm	No	TAPERED	100	68.83
KAR70515	STRAIGHT CONNECTOR	12.0mm - 17.0mm	No	TAPERED	10	10.03
KAR515	STRAIGHT CONNECTOR BULK PACKED	12.0mm - 17.0mm	No	TAPERED	100	82.47



Reducing Connectors

Cat No		O.D.	Translucent	Connection		Price
				Type	Pack	
AC3	REDUCING CONNECTOR	4.0mm - 6.0mm / 7.0mm - 10.0mm	Yes	TAPERED	50	10.69
AC3BP	REDUCING CONNECTOR BULK PACKED	4.0mm - 6.0mm / 7.0mm - 10.0mm	Yes	TAPERED	100	19.36
AC3S	REDUCING CONNECTOR O.D. STERILE	4.0mm - 6.0mm / 7.0mm - 10.0mm	Yes	TAPERED	50	23.75
AC4	REDUCING CONNECTOR	4.0mm - 6.0mm / 10.0mm - 13.0mm	Yes	TAPERED	50	11.45
AC4BP	REDUCING CONNECTOR BULK PACKED	4.0mm - 6.0mm / 10.0mm - 13.0mm	Yes	TAPERED	100	17.80
AC4S	REDUCING CONNECTOR O.D. STERILE	4.0mm - 6.0mm / 10.0mm - 13.0mm	Yes	TAPERED	50	23.95
AC6	REDUCING CONNECTOR	7.0mm - 10.0mm / 10.0mm - 13.0mm	Yes	TAPERED	50	14.59
AC6BP	REDUCING CONNECTOR BULK PACKED	7.0mm - 10.0mm / 10.0mm - 13.0mm	Yes	TAPERED	100	22.65
AC6S	REDUCING CONNECTOR O.D. STERILE	7.0mm - 10.0mm / 10.0mm - 13.0mm	Yes	TAPERED	50	25.20
KAR70877	REDUCING CONNECTOR	3.7mm - 8.2mm / 7.0mm - 11.8mm	No	TAPERED	10	10.03
KAR877	REDUCING CONNECTOR BULK PACKED	3.7mm - 8.2mm / 7.0mm - 11.8mm	No	TAPERED	100	82.47
KAR70878	REDUCING CONNECTOR	3.7mm - 7.8mm / 11.5mm - 16.0mm	No	TAPERED	10	10.75
KAR878	REDUCING CONNECTOR BULK PACKED	3.7mm - 7.8mm / 11.5mm - 16.0mm	No	TAPERED	100	89.80
KAR70879	REDUCING CONNECTOR	7.1mm - 12.0mm / 11.3mm - 15.9mm	No	TAPERED	10	11.93
KAR879	REDUCING CONNECTOR BULK PACKED	7.1mm - 12.0mm / 11.3mm - 15.9mm	No	TAPERED	100	99.99



'L' Connectors

Cat No		O.D.	Translucent	Connection		Price
				Type	Pack	
KAR71250	'L' CONNECTORS	4.0mm	Yes	UNTAPERED	10	2.87
KAR1250	'L' CONNECTORS BULK PACKED	4.0mm	Yes	UNTAPERED	10	22.60
KAR71251	'L' CONNECTORS	5.7mm	Yes	UNTAPERED	10	2.87
KAR1251	'L' CONNECTORS BULK PACKED	5.7mm	Yes	UNTAPERED	10	22.60
KAR71252	'L' CONNECTORS	7.8mm	Yes	UNTAPERED	10	3.34
KAR1252	'L' CONNECTORS BULK PACKED	7.8mm	Yes	UNTAPERED	10	26.47
KAR71253	'L' CONNECTORS	9.9mm	Yes	UNTAPERED	10	3.34
KAR1253	'L' CONNECTORS BULK PACKED	9.9mm	Yes	UNTAPERED	10	26.47
KAR71254	'L' CONNECTORS	11.8mm	Yes	UNTAPERED	10	4.30
KAR1254	'L' CONNECTORS BULK PACKED	11.8mm	Yes	UNTAPERED	10	35.23
KAR71255	'L' CONNECTORS	13.7mm	Yes	UNTAPERED	10	5.02
KAR1255	'L' CONNECTORS BULK PACKED	13.7mm	Yes	UNTAPERED	10	40.73
KAR71256	'L' CONNECTORS	15.6mm	Yes	UNTAPERED	10	6.69
KAR1256	'L' CONNECTORS BULK PACKED	15.6mm	Yes	UNTAPERED	10	54.98

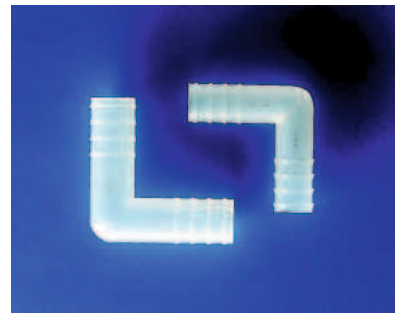

"Y" Connectors

Cat No		O.D.	Translucent	Connection		Price
				Type	Pack	
AC8	"Y" CONNECTOR (BARBLESS)	4.0mm - 5.0mm	Yes	TAPERED	50	14.25
AC8BP	"Y" CONNECTOR (BARBLESS) BULK PACKED	4.0mm - 5.0mm	Yes	TAPERED	100	28.83
AC8S	"Y" CONNECTOR (BARBLESS) STERILE	4.0mm - 5.0mm	Yes	TAPERED	50	44.00
AC9	"Y" CONNECTOR	7.0mm - 8.0mm	Yes	TAPERED	50	26.75
AC9BP	"Y" CONNECTOR BULK PACKED	7.0mm - 8.0mm	Yes	TAPERED	100	43.50
AC9S	"Y" CONNECTOR STERILE	7.0mm - 8.0mm	Yes	TAPERED	50	45.50
AC23	"Y" CONNECTOR	9.0mm - 10.0mm	Yes	TAPERED	25	14.25
AC23BP	"Y" CONNECTOR BULK PACKED	9.0mm - 10.0mm	Yes	TAPERED	100	48.89
AC23S	"Y" CONNECTOR STERILE	9.0mm - 10.0mm	Yes	TAPERED	100	82.05
HQ621	UNIVERSAL "Y" CONNECTOR	6.0mm - 15.0mm	Yes	TAPERED	10	10.20
HQ621BP	UNIVERSAL "Y" CONNECTOR LARGE BULK PACK	6.0mm - 15.0mm	Yes	TAPERED	50	38.65
AC88	"Y" CONNECTOR (BARBLESS)	6.0mm	Yes	UNTAPERED	50	16.99
AC88BP	"Y" CONNECTOR (BARBLESS) BULK PACKED	6.0mm	Yes	UNTAPERED	100	31.19
AC11	"Y" CONNECTOR	13.0mm	Yes	UNTAPERED	10	5.05
AC11BP	"Y" CONNECTOR BULK PACKED	13.0mm	Yes	UNTAPERED	100	35.85
AC11S	"Y" CONNECTOR STERILE	13.0mm	Yes	UNTAPERED	100	81.99
KAR70464	"Y" CONNECTOR	4.0mm	Yes	UNTAPERED	10	4.54
KAR464	"Y" CONNECTOR BULK PACKED	4.0mm	Yes	UNTAPERED	100	37.88
KAR70465	"Y" CONNECTOR	5.7mm	Yes	UNTAPERED	10	6.21
KAR465	"Y" CONNECTOR BULK PACKED	5.7mm	Yes	UNTAPERED	100	52.33
KAR70466	"Y" CONNECTOR	7.6mm	Yes	UNTAPERED	10	6.93
KAR466	"Y" CONNECTOR BULK PACKED	7.6mm	Yes	UNTAPERED	100	58.04
KAR70467	"Y" CONNECTOR	9.9mm	Yes	UNTAPERED	10	7.88
KAR467	"Y" CONNECTOR BULK PACKED	9.9mm	Yes	UNTAPERED	100	66.18
KAR70468	"Y" CONNECTOR	11.6mm	Yes	UNTAPERED	10	9.31
KAR468	"Y" CONNECTOR BULK PACKED	11.6mm	Yes	UNTAPERED	100	78.81
KAR70525	"Y" CONNECTOR	13.7mm	Yes	UNTAPERED	10	10.75
KAR525	"Y" CONNECTOR BULK PACKED	13.7mm	Yes	UNTAPERED	100	89.80
KAR70526	"Y" CONNECTOR	15.7mm	Yes	UNTAPERED	10	12.42
KAR526	"Y" CONNECTOR BULK PACKED	15.7mm	Yes	UNTAPERED	100	102.63

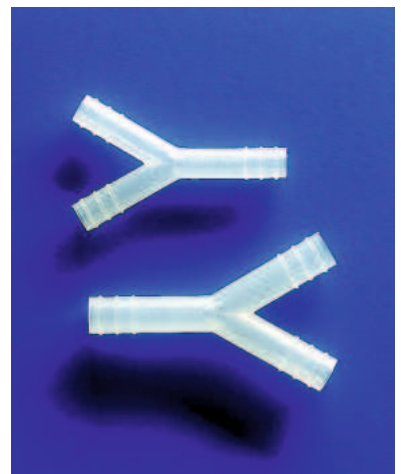

Section 37 - Tubing Connectors & Accessories

"T" Connectors

Cat No		O.D.	Translucent	Connection		
				Type	Pack	Price
AC13	T CONNECTOR	5.0mm - 7.0mm	Yes	TAPERED	50	10.45
AC13BP	T CONNECTOR BULK PACKED	5.0mm - 7.0mm	Yes	TAPERED	100	16.30
AC14	T CONNECTOR	7.0mm - 9.0mm	Yes	TAPERED	50	21.50
AC14BP	T CONNECTOR BULK PACKED	7.0mm - 9.0mm	Yes	TAPERED	100	35.75
AC14S	T CONNECTOR STERILE	7.0mm - 9.0mm	Yes	TAPERED	100	77.15
AC15	T CONNECTOR	10.0mm - 13.0mm	Yes	TAPERED	25	16.45
AC15BP	T CONNECTOR BULK PACKED	10.0mm - 13.0mm	Yes	TAPERED	100	50.35
KAR70459	T CONNECTOR	3.6mm	Yes	UNTAPERED	10	3.10
KAR459	T CONNECTOR BULK PACKED	3.6mm	Yes	UNTAPERED	100	26.47
KAR70460	T CONNECTOR	5.4mm	Yes	UNTAPERED	10	4.30
KAR460	T CONNECTOR BULK PACKED	5.4mm	Yes	UNTAPERED	100	35.23
KAR70461	T CONNECTOR	7.6mm	Yes	UNTAPERED	10	4.54
KAR461	T CONNECTOR BULK PACKED	7.6mm	Yes	UNTAPERED	100	37.47
KAR70462	T CONNECTOR	9.5mm	Yes	UNTAPERED	10	5.49
KAR462	T CONNECTOR BULK PACKED	9.5mm	Yes	UNTAPERED	100	46.23
KAR70463	T CONNECTOR	11.5mm	Yes	UNTAPERED	10	6.69
KAR463	T CONNECTOR BULK PACKED	11.5mm	Yes	UNTAPERED	100	54.98
KAR70520	T CONNECTOR	13.7mm	Yes	UNTAPERED	10	7.65
KAR520	T CONNECTOR BULK PACKED	13.7mm	Yes	UNTAPERED	100	63.94
KAR70521	T CONNECTOR	15.6mm	Yes	UNTAPERED	10	8.84
KAR521	T CONNECTOR BULK PACKED	15.6mm	Yes	UNTAPERED	100	72.29

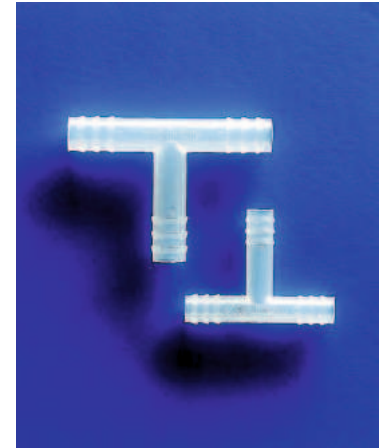

120° 'Y' Connectors

Cat No		O.D.	Translucent	Connection		
				Type	Pack	Price
KAR70527	120° 'Y' CONNECTOR	4.1mm - 5.1mm	No	TAPERED	10	9.55
KAR527	120° 'Y' CONNECTOR BULK PACKED	4.1mm - 5.1mm	No	TAPERED	100	78.81
KAR70528	120° 'Y' CONNECTOR	5.5mm - 7.2mm	No	TAPERED	10	10.74
KAR528	120° 'Y' CONNECTOR BULK PACKED	5.5mm - 7.2mm	No	TAPERED	100	89.80
KAR70529	120° 'Y' CONNECTOR	7.0mm - 9.2mm	No	TAPERED	10	12.42
KAR529	120° 'Y' CONNECTOR BULK PACKED	7.0mm - 9.2mm	No	TAPERED	100	102.63
KAR70530	120° 'Y' CONNECTOR	9.9mm - 11.5mm	No	TAPERED	10	13.14
KAR530	120° 'Y' CONNECTOR BULK PACKED	9.9mm - 11.5mm	No	TAPERED	100	105.08
KAR70531	120° 'Y' CONNECTOR	12.0mm - 14.2mm	No	TAPERED	10	15.52
KAR531	120° 'Y' CONNECTOR BULK PACKED	12.0mm - 14.2mm	No	TAPERED	100	124.22
KAR70532	120° 'Y' CONNECTOR	13.7mm - 15.5mm	No	TAPERED	10	17.43
KAR532	120° 'Y' CONNECTOR BULK PACKED	13.7mm - 15.5mm	No	TAPERED	100	143.16



4 Way Connectors

Cat No		O.D.	Translucent	Connection		
				Type	Pack	Price
KAR71410	4 WAY CONNECTOR	3.4mm	Yes	UNTAPERED	10	9.55
KAR1410	4 WAY CONNECTOR BULK PACKED	3.4mm	Yes	UNTAPERED	100	78.81
KAR71411	4 WAY CONNECTOR	5.6mm	Yes	UNTAPERED	10	10.03
KAR1411	4 WAY CONNECTOR BULK PACKED	5.6mm	Yes	UNTAPERED	100	82.47
KAR71412	4 WAY CONNECTOR	7.4mm	Yes	UNTAPERED	10	10.75
KAR1412	4 WAY CONNECTOR BULK PACKED	7.4mm	Yes	UNTAPERED	100	87.16
KAR71413	4 WAY CONNECTOR	9.5mm	Yes	UNTAPERED	10	12.42
KAR1413	4 WAY CONNECTOR BULK PACKED	9.5mm	Yes	UNTAPERED	100	102.63
KAR71414	4 WAY CONNECTOR	11.5mm	Yes	UNTAPERED	10	11.93
KAR1414	4 WAY CONNECTOR BULK PACKED	11.5mm	Yes	UNTAPERED	100	109.76
KAR71415	4 WAY CONNECTOR	13.5mm	Yes	UNTAPERED	10	13.37
KAR1415	4 WAY CONNECTOR BULK PACKED	13.5mm	Yes	UNTAPERED	100	112.20
KAR71416	4 WAY CONNECTOR	15.4mm	Yes	UNTAPERED	10	14.81
KAR1416	4 WAY CONNECTOR BULK PACKED	15.4mm	Yes	UNTAPERED	100	123.61

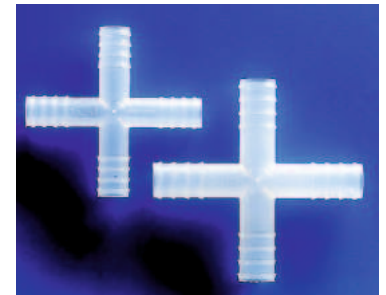

Disconnectors

Cat No		O.D.	Translucent	Connection		
				Type	Pack	Price
KAR70434	DISCONNECTOR	3.5mm - 6.0mm	Yes	TAPERED	10	7.41
KAR434	DISCONNECTOR BULK PACKED	3.5mm - 6.0mm	Yes	TAPERED	100	63.33
KAR70435	DISCONNECTOR	5.3mm - 7.6mm	Yes	TAPERED	10	8.83
KAR435	DISCONNECTOR BULK PACKED	5.3mm - 7.6mm	Yes	TAPERED	100	75.14
KAR70436	DISCONNECTOR	7.2mm - 9.7mm	Yes	TAPERED	10	10.27
KAR436	DISCONNECTOR BULK PACKED	7.2mm - 9.7mm	Yes	TAPERED	100	87.36
KAR70535	DISCONNECTOR	9.3mm - 12.2mm	Yes	TAPERED	10	10.75
KAR535	DISCONNECTOR BULK PACKED	9.3mm - 12.2mm	Yes	TAPERED	100	87.16
KAR70536	DISCONNECTOR	11.0mm - 14.4mm	Yes	TAPERED	10	12.65
KAR536	DISCONNECTOR BULK PACKED	11.0mm - 14.4mm	Yes	TAPERED	100	105.08
KAR70537	DISCONNECTOR	13.2mm - 16.0mm	Yes	TAPERED	10	13.86
KAR537	DISCONNECTOR BULK PACKED	13.2mm - 16.0mm	Yes	TAPERED	100	114.65



Tubing Clips and Clamps

Tubing clips easily clip around tubing up to 10mm O.D. They can be released and re-fastened at any time.

Tubing clamps incorporate a screw down gate for a secure grip.

Cat No		Pack	Price	+10
ATC3	HENLEY TUBING CLIP	200	22.50	21.50
NSC1	HENLEY TUBING (GATE) CLAMP	100	80.55	77.70

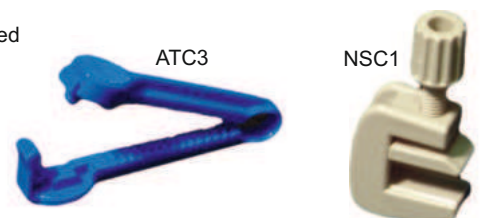

Baby Boards - I.V. Supports



A soft foam cushion on an aluminium base provides maximum immobilisation of the limb while securing I.V. lines. The support can be adjusted to fit around the elbow, leg or heel. Our Baby Boards are supplied complete with fixing tape which is specifically designed to securely hold the board in place.

Cat No		Pack	Price
6201	BABY BOARD PREMATURE 3"	50	57.00
6202	BABY BOARD NEONATAL/SMALL SIZE 4"	50	53.00
6203	BABY BOARD INFANT/LARGE SIZE 5"	50	53.00

Baby Shades - Phototherapy Eye Protectors

The hydrogel adhesive provides excellent adhesion without irritating delicate skin and allows easy removal and re-application. Included in the pack is the "keeper strap" which, if required, can be used to stop the shades from moving on active infants.

The shades are manufactured from a very soft foam fabric which provides a comfortable fit.

Cat No		Pack	Price	5+
EP6002	PHOTOTHERAPY EYE PROTECTOR SMALL	50	66.00	64.00
EP6003	PHOTOTHERAPY EYE PROTECTOR LARGE	50	66.00	64.00



ARGYLE™ Umbilical Vessel Catheters

The Argyle™ polyurethane umbilical vessel catheter (UVC) portfolio includes single, double and triple lumen catheters. Double and triple lumen catheters can benefit the patient by reducing the need for painful venipunctures by allowing simultaneous multiple therapies from one device.

Cat No		French		
		Size	Pack	Price
8888160325	12" SINGLE LUMEN	2.5	10	64.00
8888160333	15" SINGLE LUMEN	3.5	10	64.00
8888160341	15" SINGLE LUMEN	5.0	10	64.00
8888160531	15" DOUBLE LUMEN 20, 23ga	3.5	5	68.16
8888160556	15" DOUBLE LUMEN 18, 21ga	5.0	5	68.16
8888160648	15" TRIPLE LUMEN 18, 21, 21ga	5.0	5	108.80
8888160663	15" TRIPLE LUMEN 15, 18, 18ga	8.0	5	108.80

- Single, double and triple lumen catheters
- Polyurethane formulation
- Clear, lipid-resistant Luer Lock hubs
- Completely encapsulated X-ray opaque lines
- Numerical depth markings every 1cm
- Smooth, rounded atraumatic tip
- Colour-coded I.V. extensions on double and triple lumen catheters
- Sterile, multiple sizes and lengths
- Latex- and DEHP-free



ARGYLE™ DeLee Mucus Specimen Traps

Mucus traps are available for oral use only, mechanical use only or oral/mechanical suctioning. The DeLee Mucus Traps with vacuum breaker and filter come complete with catheter and hydrophobic filter and are ready to use.



ARGYLE™ DeLee Mucus trap

- Individually sterile-packed
- Three sizes, 6.5, 8 and 10 French Gauge
- Transparent 20cc graduated mucus traps with removable cap for easy measurement of specimen
- Whistle tip catheter with SLIDE-TEX™ finish allows efficient suction with ease of insertion and withdrawal
- Latex-free

ARGYLE™ DeLee Mucus trap with vacuum breaker and filter

- Individually sterile-packed
- Three sizes, 6.5, 8 and 10 French Gauge
- Transparent 20cc graduated mucus traps with removable cap for easy measurement of specimen
- Oral/mechanical or oral use only options
- Extra trap cap to reduce spillage during transport
- Whistle tip catheter with SLIDE-TEX™ finish allows efficient suction with ease of insertion and withdrawal
- Advanced hydrophobic filter shuts down when it comes into contact with fluid, protecting the clinician against contact with the specimen

ARGYLE™ Specimen Trap

- Individually sterile-packed
- Transparent 40cc graduated trap with removable cap for easy measurement of specimen
- Second screw-on cap to reduce spillage during transport
- Latex-free

Cat No		Pack	Price
8888257527	ARGYLE DELEE SUCTION CATHETER 10Fr MUCUS TRAP 20cc	50	78.40
8888257535	ARGYLE DELEE SUCTION CATHETER 8Fr MUCUS TRAP 20cc	50	78.40
8888257550	ARGYLE DELEE SUCTION CATHETER 6.5Fr MUCUS TRAP 20cc	50	78.40
8888257469	ARGYLE DELEE SUCTION CATHETER 10Fr MUCUS TRAP 20cc WITH VACUUM BREAKER AND FILTER	50	133.00
8888257477	ARGYLE DELEE SUCTION CATHETER 8Fr MUCUS TRAP 20cc WITH VACUUM BREAKER AND FILTER	50	137.20
8888257485	ARGYLE DELEE SUCTION CATHETER 6.5Fr MUCUS TRAP 20cc WITH VACUUM BREAKER AND FILTER	50	142.80
88884724500	ARGYLE NEO SAFE BUBBLE SPECIMEN TRAP 40CC	50	119.00



Section 38 - Uncategorized

Disposable Tape Measure

A tough paper disposable tape measure with space available for baby measurements, scaled in inches and millimetres.



Cat No	Pack	Price	50+	100+
TM30	DISPOSABLE TAPE MEASURE	100	5.10	4.90 4.75

IV Armboards



A safe convenient method for arm support during intravenous administration. Plastic foam padding offers soft and comfortable support for the patient. A heavy grade vinyl cover keeps the products protected from damage and resists fluids and stains. Welded tabs allow two boards to be tied together where required.

Cat No	Pack	Price	20+
PCA18	I.V. ELBOW ARMBOARD 18" LARGE	Each	4.25 3.95
PCA12	I.V. FOREARM ARMBOARD 12" SMALL	Each	3.40 3.20

Patient Identification Bands



Available in either adult or infant sizes, adjustable to patient wrist. Can be supplied with write-on card inserts or write-on panel. ID Band Marking Pens are also available separately. The most recent addition to this range is our pre-printed "allergy" band. Other pre-printed bands are available upon request.

Cat No	Pack	Price	4+	8+
7341	WHITE ID BANDS INFANT SIZE WITH CARD INSERT	250	42.00	40.40 39.85
7143	GREEN ID BANDS ADULT SIZE WITH CARD INSERT	250	44.15	43.60 42.00
7144	RED ID BANDS ADULT SIZE WITH CARD INSERT	250	44.15	43.60 42.00
7101	WHITE ID BANDS ADULT SIZE WITH WRITE-ON PANEL	250	44.95	44.15 43.60
7104	RED ID BANDS ADULT SIZE WITH WRITE-ON PANEL	250	44.40	43.90 42.25
3304A	RED ID BANDS ADULT SIZE PRE-PRINTED "ALLERGY"	500	65.50	64.50 63.50
Cat No	Pack	Price	12+	
PENBK	ID BAND MARKING PEN WATER- AND ALCOHOL-RESISTANT	EACH	1.45	1.40

Strap Closures



Strap closures are similar to cable ties but unlike cable ties they are reusable. A typical application would be for sealing refuse sacks or bags and securing cables.

Cat No	Pack	Price	3+	5+
SCL2000R	STRAP CLOSURE 8" RED	2000	92.50	88.50 84.50
SCL2000W	STRAP CLOSURE 8" WHITE	2000	82.00	79.50 78.00

Curity™ Gauze Sponges - Non-Sterile



Curity™ Gauze Sponges Non-Sterile exceed USP Type VII gauze requirements. Well suited to a variety of applications. Available in a range of sizes conveniently indexed in 10's for faster, easier handling.

Cat No	Pack	Price
2252	CURITY GAUZE SPONGES, 12 PLY, 2" x 2" (5.1 cm x 5.1 cm)	8000 69.60
2346	CURITY GAUZE SPONGES, 12 PLY, 3" x 3" (7.6 cm x 7.6 cm)	4000 69.60
2556	CURITY GAUZE SPONGES, 8 PLY, 4" x 4" (10.2 cm x 10.2 cm)	4000 104.40
2634	CURITY GAUZE SPONGES, 12 PLY, 4" x 4" (10.2 cm x 10.2 cm)	2000 69.60

Micro Cover Slip

A 0.2mm (± 10%) thick unbreakable plastic cover slip used as a safe alternative to glass microscope slides. Supplied in packs of 1000, containing 10 inner boxes of 100. Each slide is interleaved with tissue to prevent scratching.

Cat No	Pack	Price	10+
MCS1	MICRO COVER SLIPS 22x22mm	1000	17.25 16.75



Mixing Kwill/Needle

A 12.7cm length mixing kwill/needle for use with narrow-necked ampoules or vials. Virtually transparent, it will not kink in use. Moulded Luer fitting and tapered distal end. External diameter 4.95mm, internal diameter 3.94mm. Supplied sterile.



Cat No	Pack	Price	12+	48+
MN5 MIXING KWILL/NEEDLES 12.7cm	100	20.70	20.50	20.20

Wash Square



An absorbent soft foam square used for cleaning. An alternative to wipes, particularly useful for heavy soiling.

Cat No	Pack	Price
WS100D SANDREX DISPOSABLE FOAM WASH SQUARES	100	5.60

Blood Lancets

Surgilance™ Safety Lancets make blood sampling easier for the clinician and more comfortable for the patient. The lancets do not require arming and are available in depths from 1.0mm to 2.3mm, with each depth uniquely colour-coded and suitable for different applications. A high speed delivery and penetration method minimises patient pain and clinical error and, once the lancet has been used, it is rendered inoperable for maximum safety.



Surgilance™
Safety Lancets

Cat No	Type	Colour	Depth	Gauge*	Blood Flow	Pack	Price	10+
SLN100	NEEDLE	YELLOW	1.0mm	G26	LOW 5-10µl	100	22.00	21.00
SLN200	NEEDLE	GREY	1.8mm	G23	LOW 10-20µl	100	22.00	21.00
SLN240	NEEDLE	ORANGE	2.2mm	G22	MED 20-40µl	100	22.00	21.00
SLN300	NEEDLE	PINK	2.8mm	G21	HIGH 40-60µl	100	22.00	21.00
SLB200	BLADE	GREEN	1.8mm	G19	HIGH 75-100µl	100	23.00	22.00
SLB250	BLADE	BLUE	2.3mm	G18	HIGH 150-200µl	100	23.00	22.00

* = Standard Wire Gauge, at point of penetration.

The **Medipoint™** Steel Blood Lancet is made from high quality stainless steel and will not bend in use. The ridges along the length strengthen the lancet and provide a confident grip without the risk of slipping. The extra thick steel point has a triple-bevelled edge which tapers to a point from all sides, meaning it is far less painful for the patient. Supplied in packs of 200, individually sterile-packed.



Cat No	Pack	Price	50+	100+
BL2 MEDIPOINT BLOOD LANCET	200	3.80	3.60	3.50

Urine Drainage Bag Hanger

A simple hook-over style hanger that allows a urine drainage bag to be attached to the side of the bed and/or easily moved.



Cat No	Pack	Price	100+
UBH2 URINE BAG HANGER	Each	1.55	1.50

Carebag® Vomit Bag with GelMax®



The CareBag® Vomit Bag with Super absorbent GelMax® Pad was specifically designed to replace the traditional vomit bowl and can be used by children or adults. Housed in a convenient dispenser box, the individual bag absorbs contents in seconds and confines odours. When closed and tied, the vomit bag eliminates clean-up associated with disposable or reusable bowls.

Cat No	Pack	Price
7733987 CAREBAG VOMIT BAGS WITH GELMAX, DISPOSABLE	20	12.35

Disposable Razor

This facial razor has a single high quality blade and is supplied with a protective head cover.



Cat No	Pack	Price	5+	10+
RAZ5 BIC DISPOSABLE SKIN SENSITIVE RAZOR	200	35.95	35.25	34.50

Section 38 - Uncategorized

Patella Hammer

A Babinski-style patella hammer with a metal handle. The handle can be attached straight or at a right angle to the head.



Cat No	Pack	Price
HS401G5 BABINSKI-STYLE PATELLA HAMMER	Each	3.40

Tongue Depressor & Wooden Applicator

Our tongue depressor is made from selected high quality, sustainably sourced birchwood. It is produced with bevelled edges and a high satin finish.



The Wooden Applicator is made from high quality birchwood with a smooth satin finish.



Cat No	Pack	Price	50+	100+
TDA3 TONGUE DEPRESSOR ADULT 150mm x 19mm	100	2.05	2.00	1.95
Cat No	Pack	Price	25+	50+
WAS2 WOODEN APPLICATOR 152mm x 2.2mm DIA	1000	4.05	3.85	3.60

Marker Pens

Artline all-purpose marker pens have strong acrylic fibre tips which write smoother and last longer than ordinary felt tip pens. Artline pens have a waterproof, quick-drying ink which is xylene-free.

All pens are supplied in boxes of 12 and a range of colours is available.



Cat No	Pack	Price	10+
ALP1 ARTLINE 70 1.5mm BULLET TIP PEN BLACK	12	16.30	15.25
ALP2 ARTLINE 70 1.5mm BULLET TIP PEN BLUE	12	16.30	15.25
ALP3 ARTLINE 70 1.5mm BULLET TIP PEN GREEN	12	16.30	15.25
ALP4 ARTLINE 70 1.5mm BULLET TIP PEN RED	12	16.30	15.25
ALP5 ARTLINE 70 1.5mm BULLET TIP PEN ORANGE	12	16.30	15.25
ALP6 ARTLINE 70 1.5mm BULLET TIP PEN PURPLE	12	16.30	15.25
ALP7 ARTLINE 70 1.5mm BULLET TIP PEN BROWN	12	16.30	15.25
ALP8 ARTLINE 70 1.5mm BULLET TIP PEN YELLOW	12	16.30	15.25
ALP7001 ARTLINE 700 0.4mm FINE TIP PEN BLACK	12	15.99	14.89
ALP7002 ARTLINE 700 0.4mm FINE TIP PEN BLUE	12	15.99	14.89
ALP7003 ARTLINE 700 0.4mm FINE TIP PEN GREEN	12	15.99	14.89
ALP7004 ARTLINE 700 0.4mm FINE TIP PEN RED	12	15.99	14.89

Lemon & Glycerine Swabs



The Lemon and Glycerine Swab relies on the tangy citrus flavour of lemon to stimulate the patient's taste buds and excite the salivary glands. Glycerine further stimulates the production of saliva.

Our swab is particularly suitable for patients on oxygen or fluid restrictions, comatose patients on IVs and terminally ill patients. Also suitable for routine oral care of elderly patients in hospices or at home. Supplied in sachets of 3 swabs with 25 sachets per pack.

Cat No	Pack	Price	10+	50+
LGS25 HENLEY LEMON & GLYCERINE SWABS	25x3	5.99	5.35	4.95

Catheter Spigots



Individually packed sterile, available in two sizes and suitable for all standard catheters and tubes. The tapered design gives a positive fit and the flanged spigot head provides maximum grip, assisting withdrawal of the spigot from the catheter. **Small** size, 50 x 10mm diameter at top end, fits 3 - 8mm. **Large** size, 50 x 13mm diameter at top end, fits 4 - 12mm. Supplied in packs of 100.

Cat No	Pack	Price	20+
CSP5 CATHETER SPIGOT STERILE SMALL	100	15.00	14.70
CSP6 CATHETER SPIGOT STERILE LARGE	100	15.00	14.70



Absorbent Theatre Mats

Made from melt-blown polypropylene, the mat has an impermeable base to prevent liquids passing through onto the floor. The top cover is made from a heavy duty spun-bond material which is designed to increase tensile and surface strength to compensate for heavy traffic. The product has an excellent strike-through which enables liquids to quickly dissipate across the surface area and into the central fibre which then captures and stores unwanted fluids.

Heavy Duty Theatre Mat

Size: 80 x 150cm
Absorbency: 6 Litres per pad



Medium Weight Theatre Mat

Size: 80 x 100cm
Absorbency: 3 Litres per pad



Lightweight Theatre Mat

Size: 80 x 40cm
Absorbency: 2 Litres per pad



Cat No		Pack	Price
M8080150	HEAVY DUTY ABSORBENT THEATRE MAT 80 x 150cm, 6lt ABSORBENCY	15	84.40
M8080100	MEDIUM WEIGHT ABSORBENT THEATRE MAT 80 x 100cm, 3lt ABSORBENCY	20	82.57
M8080040	LIGHTWEIGHT ABSORBENT THEATRE MAT 80 x 40cm, 2lt ABSORBENCY	40	93.64

Dissecting Forceps

Disposable dissecting forceps are supplied individually sterile-wrapped.

Cat No		Pack	Price
H7301	DISSECTING FORCEPS STERILE IN PEEL-POUCH PACKING	52	9.00



Jetpull Variable Tourniquet



A 50cm long tourniquet with a double-lock system which allows both slow and fast release.

Cat No		Pack	Price
2020	JETPULL 2 LATEX-FREE VARIABLE TOURNIQUET	Each	4.45

Screen & Shower Curtains



Our screen & shower curtains are made to order in opaque white PVC. The PVC is impregnated to resist bacteria, mould and mildew, ensuring lasting freshness and hygiene. Use the matrix to check prices. Please note a minimum order quantity of 10 curtains applies.

	Width					
	Up to 91cm Up to 36"	Up to 122cm Up to 48"	Up to 137cm Up to 54"	Up to 183cm Up to 72"	Up to 244cm Up to 96"	Up to 274cm Up to 108"
	No of Eyelets					
	8	10	11	14	18	20
Drop	Price £					
Up to 40" 102cm	11.33	11.82	12.05	12.79	13.75	14.23
Up to 50" 127cm	11.59	12.16	12.44	13.30	14.44	15.00
Up to 60" 152cm	11.85	12.51	12.83	13.82	15.13	15.78
Up to 70" 178cm	12.11	12.85	13.22	14.34	15.82	16.55
Up to 80" 203cm	12.37	13.20	13.60	14.85	16.51	17.33
Up to 90" 229cm	12.63	13.54	13.99	15.37	17.20	18.10
Up to 100" 254cm	12.88	13.89	14.38	15.89	17.89	18.87

Ordering is Easy

Six Ordering Methods

1

Phone - 01707 333164 / 385226

Our sales lines are open from 8:45am - 4:45pm Monday to Thursday, 8:45am - 4:30pm Friday.

2

**Post - Henleys Medical Supplies
Brownfields, Welwyn Garden City
Herts AL7 1AN**

3

Fax - 01707 334795

4

Email - salesorders@henleysmed.com

5

Website - henleysmed.com

6

**E-Trading - Call our team on 01707 333164
to discuss your electronic
trading requirements**



ORDERING INFORMATION

Please provide the following information when ordering:

- * Your Name, * Telephone Number, * Account Number (if known), * Delivery and Invoice Addresses, * Order Number,
- * Catalogue Numbers with Descriptions and Quantities required.

Confirmation orders must be marked clearly to avoid duplication.

STANDARD CONDITIONS OF SALE

Product Descriptions	Product descriptions are subject to alteration without notice and are not binding. Specifications are only intended to represent the type of goods offered. Design improvements may not be detailed within the description.
Prices	Prices are subject to VAT and alteration without prior notice. We reserve the right to invoice goods at ruling prices on the date the order is received. Prices shown in our catalogue are correct at date of print.
Quotations	All offers, written or verbal, are valid for 30 days, unless otherwise specified. The right is reserved to amend any accidental errors.
Minimum Order Value	Our minimum goods value requirement per order is £15.00 (excluding VAT).
Delivery and Handling	UK Mainland (including IOW) - A handling/delivery charge at the rate applicable on the date of despatch (currently £8.45) will apply to any consignment below a specified goods value, which is currently £200 excluding VAT. Above this value no charge, unless an upgraded delivery service is required. Off Mainland – A handling/delivery charge at the rate applicable on the date of despatch (currently £18.00) will apply to any consignment below a specified goods value, which is currently of £300 excluding VAT. Above this value no charge, unless an upgraded delivery service is required.
Delivery of Goods	Our standard delivery to UK Mainland is normally within 3 working days & off UK Mainland 5 working days following receipt of order, subject to stock availability. Upon request an upgraded service might be available, the cost of which will be advised prior to despatch.
Damaged Delivered Goods	Claims must be made verbally within 2 working days from delivery and confirmed in writing. If damage is evident upon delivery of the consignment, the Carrier's delivery document should be endorsed accordingly. Goods and packaging should be retained for inspection.
All Other Claims	Claims should be made verbally within 21 days of despatch, and confirmed in writing.
Payment of Accounts	<ul style="list-style-type: none"> - Credit available on application subject to approval. - Please note, we understand and will exercise our statutory right to claim interest (currently 8% over BOE base rate per annum) and compensation for administrative costs under the late payment legislation, as amended 7th August 2002, if we are not paid according to our credit terms.

POLICY ON RETURNED AND REPLACEMENT GOODS

RETURNED GOODS - Goods are accepted back for credit at the discretion of our Purchasing Manager, but generally the following policy applies.

- Requests for the return of goods must be made within 21 days of supply.
- Items will not normally be accepted back for credit if:-
 - The product is not a stock line, (i.e. purchased specifically to fulfil an order), quantities involving a special production run or customised items. If the order requirements fall into any of these categories we may request signed acknowledgement before the order is processed.
- Items will be accepted back for credit if:-
 - Goods have been supplied in error by Henleys Medical Supplies Limited or faulty, irrespective of value.
 - Goods have been ordered in error by the Customer, providing the items are stock lines, are returned in a saleable condition and not exceeding a total value of £500.00.

It is often the case that manufacturers apply additional costs or refuse to issue credit for returned goods. Regrettably, therefore, if goods have been ordered in error by the Customer, a handling charge (minimum 10%) may be deducted from the value of returned goods.

Goods should be returned to the address shown at the foot of this page together with a copy of the original Delivery Advice Note. If required, we will arrange collection but this service will be charged at cost if due to Customer error.

REPLACEMENT GOODS - We do not offer direct exchanges. A new invoice is raised for any replacements. Applicable credit is issued in due course for returned goods.

Henleys Medical Supplies Limited is registered in England Reg.452882
 Registered Office: Brownfields, Welwyn Garden City, Herts. AL7 1AN
 VAT Registration No. GB 229 2540 68
 WEEE Producer Registration No.WEE/BD0043SY



2015/16



HENLEYS MEDICAL SUPPLIES LIMITED

Brownfields, Welwyn Garden City, Herts, England AL7 1AN

Tel 01707 333164 Fax 01707 334795

www.henleysmed.com