

SHOPKIT

QUALITY

PRECISION

CREATIVITY

FLEXIBILITY



TZ LIGHTING

MADE IN THE UK

TZ LIGHTING

The TZ low voltage lighting range provides exceptional flexibility and is available with connectors for Shopkit's tensioned Cable and 6mm Rod systems, to create runs of catenary and cabinet lighting as well as 'disc' mountings to enable the positioning of lights on ceiling or panels with remote siting of transformer.

It can also be incorporated with display shelving or stand alone as required. The lamps are available with two different styles of head: The Rotating head swings through an arc of 290° in one plane. The Multipoise head swings through arcs in two planes: the first turns through 290° the other 200°, allowing light to be directed in almost any direction.

The lamps are manufactured from solid brass for the best electrical conductivity and have a finish of the highest quality with attention to detail at all stages of manufacture ensuring ease of use and longevity. The Shopkit lighting range includes a comprehensive range of suspension systems, transformers and a wide range of lamps are available, including the new LED's providing excellent energy saving capabilities.

Made to Measure options available

The TZ lighting range is available in the following standard sizes but should variations in metal finishes, overall dimensions or complete bespoke designs be required, Shopkit offer a design and manufacturing service to meet this need.

Installation

Shopkit can deliver and install all elements within this lighting range - quotations will be supplied on request.

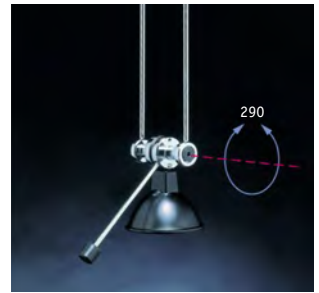

Rotating lamp head

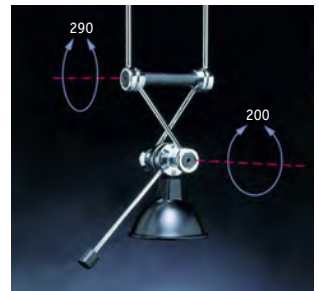

Multipoise lamp head

Lighting Gantries

Style: Ceiling mounted on cables

Uses: General lighting

These suspended lighting gantries provide directional low-voltage lighting that may be fixed at an almost unlimited distance from the fixing plain. They are available in two different configurations and may hold up to eight lamps with multipoise heads which allow for movement of the lamp to be directed in almost any direction.

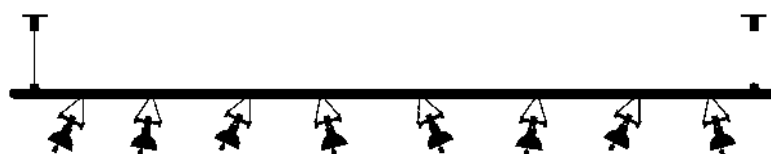

LF.24 – Lighting Gantry

300mm wide x 2400mm long holding 8 x TZ.2 with Multipoise head

 LF.24.H with Halogen lights

 LF.24.L with LED lights

The gantry frames are manufactured in silver anodised aluminium and are supplied in complete kit form. Each kit includes: gantry, cable suspension system complete with transformer, power feed, lampholders and dichroic lamps and dispatched semi-assembled, with all cabling cut to length and supplied with easy to follow instructions for construction and installation.

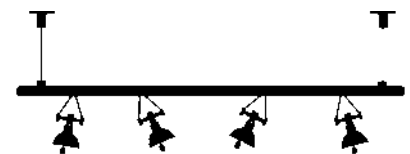

LF.12 – Lighting Gantry

300mm wide x 1200mm long holding 4 x TZ.2 with Multipoise head

 LF.12.H with Halogen lights £

 LF.12.L with LED lights

TZ.1 Crossbar Lamp with Rotating head

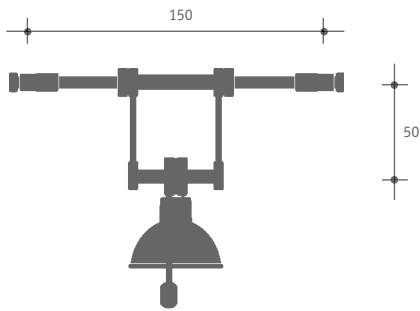

Style: Cable or rod mounted
Uses: Catenary lighting,
display, shelving lighting,
cabinet lighting

This lamp is perfect for cable or rod suspended lighting running on any angle, including vertically with display shelving and inside cabinets.

 **TZ.1.H** with Halogen light

 **TZ.1.L** with LED light



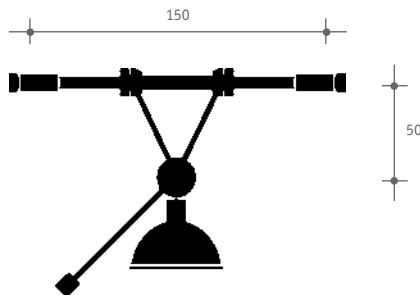

TZ.2 Crossbar Lamp with Multipoise head



Style: Cable or rod mounted
Uses: Catenary lighting,
display, shelving lighting,
cabinet lighting

This lamp is perfect for cable or rod suspended lighting running on any angle, including vertically with display shelving and inside cabinets.

 **TZ.2.H** with Halogen light

 **TZ.2.L** with LED light



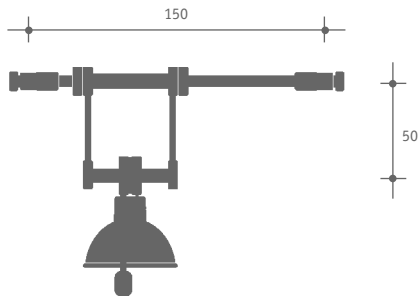

TZ.5 Offset Lamp with Rotating head



Style: Cable or rod mounted
Uses: Display, shelving lighting,
cabinet lighting

This lamp is perfect for cable or rod suspended lighting running on any angle, including vertically with display shelving and inside cabinets.

 **TZ.5.H** with Halogen light

 **TZ.5.L** with LED light



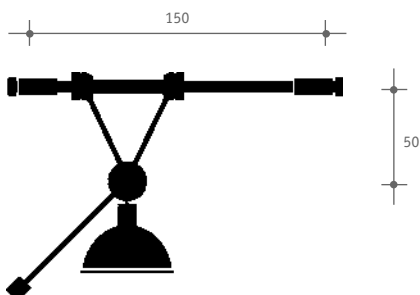

TZ.6 Offset Lamp with Multipoise head



Style: Cable or rod mounted
Uses: Display, shelving lighting,
cabinet lighting

This lamp is perfect for cable or rod suspended lighting running on any angle, including vertically with display shelving and inside cabinets.

 **TZ.6.H** with Halogen light

 **TZ.6.L** with LED light



TZ.14 Disc Pendant Lamp with Multipoise head

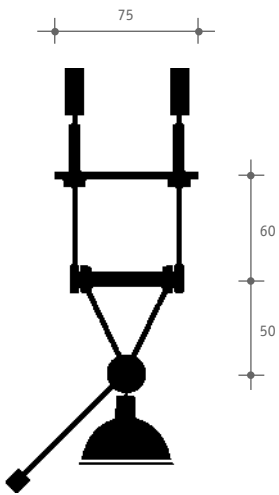

Style: Disc mounted for ceilings and panels

Uses: Display, shelving lighting, cabinet lighting

This lamp is perfect for general lighting, as well as inside cabinets.

 **TZ.14.H** with Halogen light

 **TZ.14.L** with LED light



TZ.18 Disc Pendant Lamp with Multipoise head

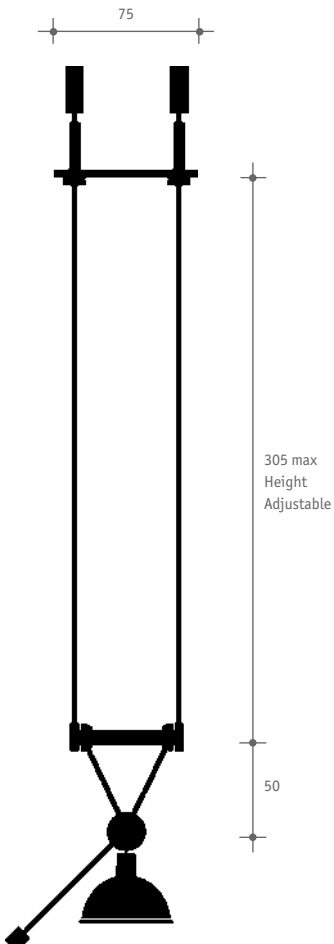

Style: Disc mounted for ceilings and panels

Uses: Display, shelving lighting, cabinet lighting

This lamp height adjustable up to 305mm and is perfect for general lighting, as well as inside cabinets.

 **TZ.18.H** with Halogen light

 **TZ.18.L** with LED light



Lamp Options

All of the lampholders within the TZ Range are available with either Halogen or LED lights and are coded and priced accordingly.



Halogen light



LED light

TZ.4 Counterpoise Lamp with Multipoise head

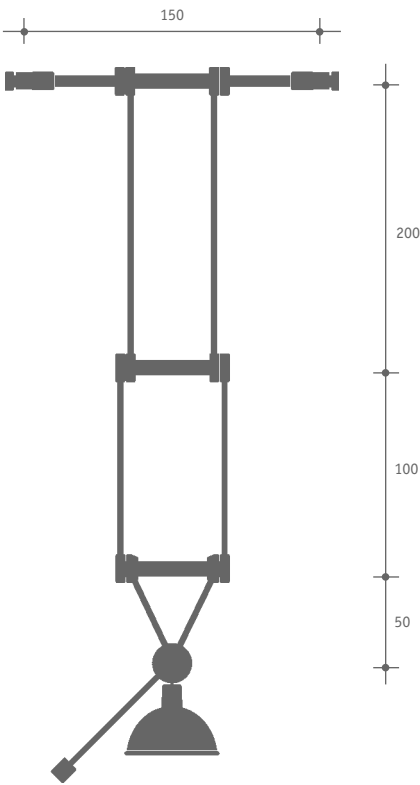

Style: Cable mounted

Uses: Catenary lighting,
display lighting

This lamp can be set to any angle to the cables and holds any given position. The multipoise head allows for movement of the light to be directed in almost any direction.

 **TZ.4.H** with Halogen light

 **TZ.4.L** with LED light



TZ.10 Pendant Lamp with Multipoise head

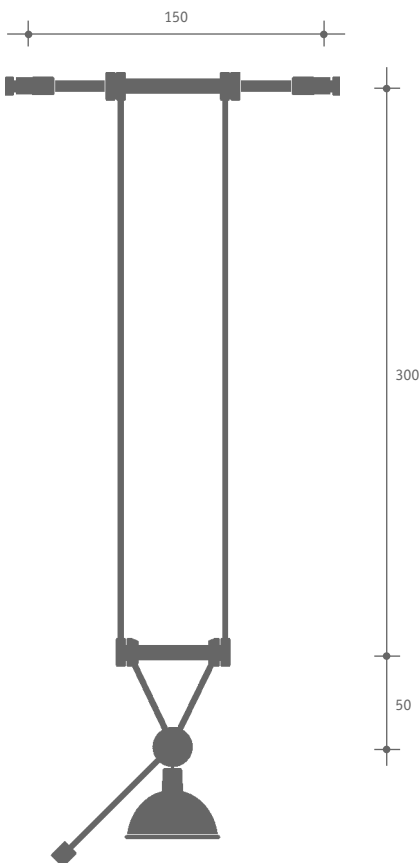

Style: Cable mounted

Uses: Catenary lighting,
display lighting

This lamp can be set to any angle to the cables and the multipoise head allows for movement of the light to be directed in almost any direction.

 **TZ.10.H** with Halogen light

 **TZ.10.L** with LED light

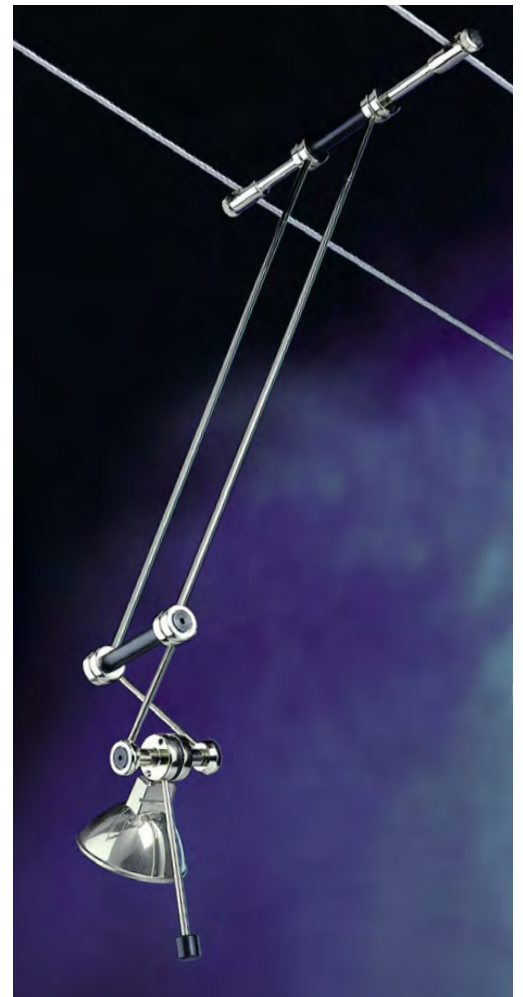

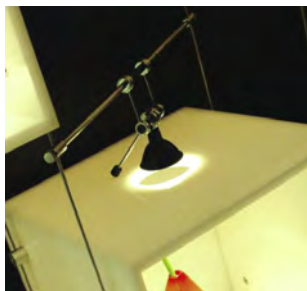
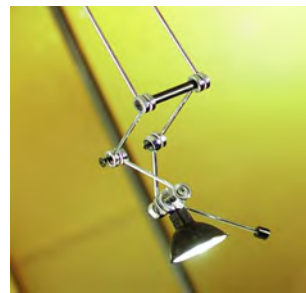

SHOPKIT GROUP LIMITED

100 Cecil Street · North Watford · Hertfordshire WD24 5AD · England

Tel: +44 (0)1923 818282 Fax: +44 (0)1923 818280 email: sales@shopkit.com web: www.shopkit.com

SHOPKIT EXPORT LIMITED

100 Cecil Street · North Watford · Hertfordshire WD24 5AD · England

Tel: +44 (0)1923 818282 Fax: +44 (0)1923 818280 email: export@shopkit.com web: www.shopkit.com