

316 STAINLESS STEEL PRECISION PIPE FITTINGS



Waverley brownall

THE COMPANY



Waverley brownall has progressed to become a leading supplier of pipeline components, valves and instrumentation products; providing solutions for the most demanding applications.

Our philosophy is dominated by quality. Each Waverley brownall product is designed using state-of-the-art CAD technology and is subjected to rigorous quality control procedures.

Waverley has built its reputation for quality instrumentation among the largest industrial companies. Our products are used on systems where corrosion resistance, high pressures, clean room environments and high temperatures are critical factors.

A range of over 2000 standard products, manufactured in the UK or sourced from approved suppliers are available ex-stock to assure you of immediate delivery whilst our engineers provide complete technical support and can assist in the design and development of custom-made solutions.

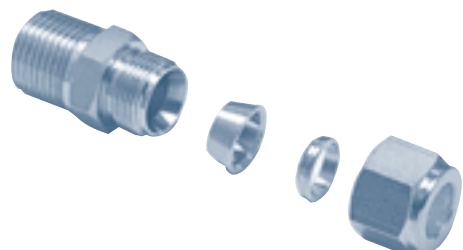
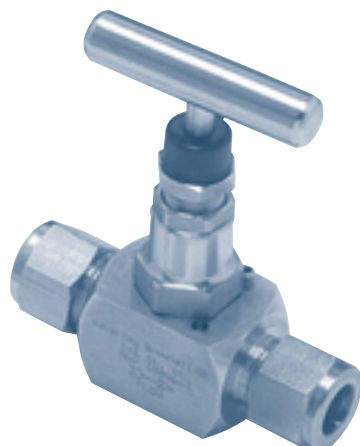
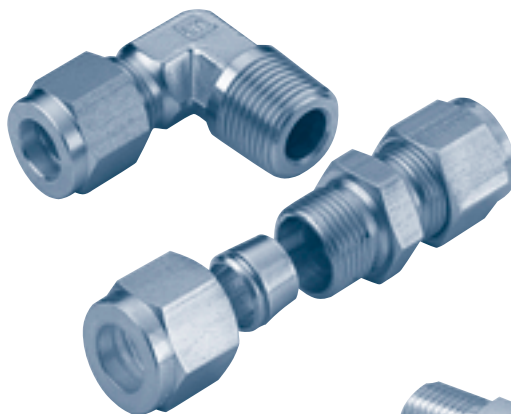
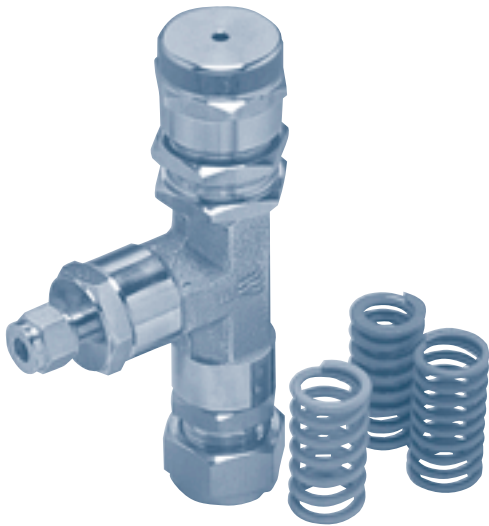

APPROVALS

Our dedication to quality has led to us being awarded and maintaining BS EN ISO 9001 since 1986.

We also hold certificates of product conformance and approvals which include:

- LLOYDS** type approval to BS part 4
- LLOYDS** general approval for classified installations
- TUV** type approval
- AF KONTROLL** design approval
- BRITISH GAS** approved supplier
- BRITISH PETROLEUM** approved supplier
- BRITISH NUCLEAR FUELS** approved supplier
- SHELL** approved supplier
- TEXACO** approved supplier
- CEGB** approval
- POWERGEN** approved supplier
- EUROPEAN GAS TURBINES** approved supplier
- AMERICAN BUREAU OF SHIPPING** type approval



UK Sales

Waverley brownall Ltd
46, The Vintners, Temple Farm Industrial Estate
Southend-on-Sea, Essex SS2 5RZ
Tel: +44 (0)1702 600014
Fax: +44 (0)1702 613600
email: sales@waverleybrownall.co.uk
www.waverleybrownall.co.uk

Waverley brownall Scotland
Tel: +44 (0)1224 877323

Featuring BSP screwed pipe fittings, 60° coned male unions, tube and hose components, plugs, bushes, caps, seals, NPT screwed pipe fittings, weld fittings and precision pipe fittings.

BSP screwed pipe fittings comply with BS 1740 or BS 1387. Reducing bushes up to 1" BSPT are stocked with taper internal threads. These are suitable for a safe working pressure of 3000psi and are used for adapting gauges, instruments and valves.

Hexagon nipples and hexagon reducing nipples up to 1" BSPT have bores to make them suitable for a safe working pressure of up to 6000psi.

60° coned male unions based on AGS 949 and BS 5200. Tube and hose adaptors based on BS 1906 and BS 2464. Any of the standpipe adaptors illustrated can be serrated to convert them to male or female hose adaptors. Standpipe adaptors are the same size as equivalent OD tube and therefore have a smaller OD than the equivalent hoesetail end.

BSPP plugs, bushes, and caps are manufactured from hexagons large enough to allow for the use of seals. Screw seal assemblies are stocked to suit all threads from 1/8" BSP - 2" BSP and suitable for a safe working pressure of 3000psi and are available in PTFE/stainless steel 316 and nitrile/stainless steel 316.

NPTF screwed pipe fittings are manufactured to comply with BS 3799. All catalogued items are stocked and suitable for use at a safe working pressure of up to 6000psi.

Weld fittings have been designed specifically for welded instrumentation systems. A necessary addition to this range is the compression to weld fitting for use on systems requiring the inline removal and replacement of certain critical components.

Waverley precision pipe fittings are manufactured from high quality 316 stainless steel forgings and each product in this range benefits from our cast coded system for easy traceability, even after many years in service. All threads available to NPT to ANSI/ASME B1.20.1.1983. BSPT to BS 21 and BSPP to BS 2779. Size range 1/8" to 1".

Waverley brownall also offer a full range of quality low pressure 316 stainless steel screwed fittings. These BSP fittings are available ex stock in sizes ranging from 1/8" to 2" and have a safe working pressure of 150 psi.

HIGH PRESSURE PRECISION RANGE	page 4-10
PLUGS, BUSHES AND SEALS	page 11-13
HOSE COMPONENTS AND UNIONS	page 14-19
LOW PRESSURE CAST RANGE	page 20-26
WELD FITTINGS	page 27-31



HIGH PRESSURE PRECISION PIPE FITTINGS

Hexagon Nipple

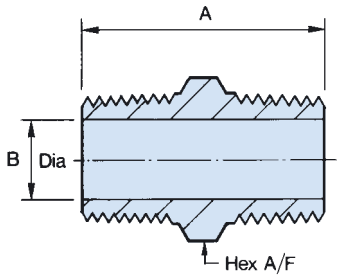

Thread BSPT	Part No	A Dim.	B Dia.	Hex A/F	WP psi
1/8"	N1	1.000"	0.156"	7/16"	6000
1/4"	N2	1.187"	0.218"	9/16"	6000
3/8"	N3	1.281"	0.343"	11/16"	6000
1/2"	N4	1.562"	0.437"	7/8"	6000
3/4"	N6	1.875"	0.625"	1 1/8"	6000
1"	N8	2.125"	0.875"	1 3/8"	5000
1 1/4"	N10	2.406"	1.125"	1 11/16"	3000
1 1/2"	N12	2.437"	1.375"	2.050"	3000
2"	N16	2.593"	1.812"	2 1/2"	3000

Thread NPT

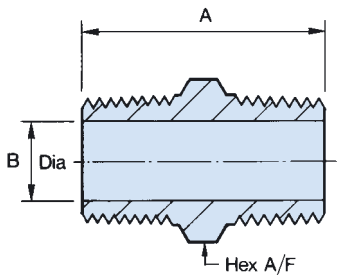

Thread NPT	Part No	A Dim.	B Dia.	Hex A/F	WP psi
1/8"	N1 NPT	1.000"	0.187"	7/16"	6000
1/4"	N2 NPT	1.187"	0.281"	9/16"	6000
3/8"	N3 NPT	1.281"	0.406"	11/16"	6000
1/2"	N4 NPT	1.562"	0.500"	7/8"	6000
3/4"	N6 NPT	1.875"	0.718"	1 1/8"	6000
1"	N8 NPT	2.125"	0.875"	1 3/8"	5000
1 1/4"	N10 NPT	2.406"	1.125"	1 11/16"	3000
1 1/2"	N12 NPT	2.437"	1.375"	2.050"	3000
2"	N16 NPT	2.593"	1.812"	2 1/2"	3000

Hexagon Reducing Nipple

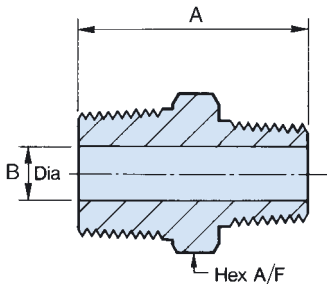

Thread BSPT	Part No	A Dim.	B Dia.	Hex A/F	WP psi
1/4" X 1/8"	RN2X1/8	1.093"	0.156"	9/16"	6000
3/8" X 1/8"	RN3X1/8	1.125"	0.156"	11/16"	6000
3/8" X 1/4"	RN3X1/4	1.218"	0.218"	11/16"	6000
1/2" X 1/4"	RN4X1/4	1.406"	0.218"	7/8"	6000
1/2" X 3/8"	RN4X3/8	1.437"	0.343"	7/8"	6000
3/4" X 1/4"	RN6X1/4	1.593"	0.218"	1 1/8"	5000
3/4" X 3/8"	RN6N3/8	1.625"	0.343"	1 1/8"	5000
3/4" X 1/2"	RN6X1/2	1.750"	0.437"	1 1/8"	3000
1" X 1/2"	RN8X1/2	1.875"	0.437"	1 3/8"	3000
1" X 3/4"	RN8X3/4	2.000"	0.625"	1 3/8"	3000

Thread NPT

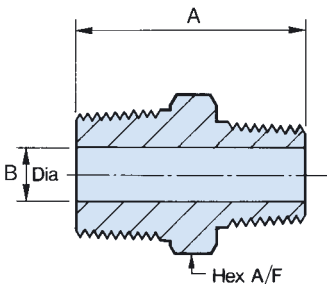

Thread NPT	Part No	A Dim.	B Dia.	Hex A/F	WP psi
1/4" X 1/8"	RN2X1/8 NPT	1.187"	0.187"	9/16"	6000
3/8" X 1/8"	RN3X1/8 NPT	1.218"	0.187"	11/16"	6000
3/8" X 1/4"	RN3X1/4 NPT	1.406"	0.281"	11/16"	6000
1/2" X 1/4"	RN4X1/4 NPT	1.593"	0.281"	7/8"	6000
1/2" X 3/8"	RN4X3/8 NPT	1.625"	0.406"	7/8"	6000
3/4" X 1/4"	RN6X1/4 NPT	1.687"	0.281"	1 1/8"	5000
3/4" X 3/8"	RN6N3/8 NPT	1.687"	0.406"	1 1/8"	5000
3/4" X 1/2"	RN6X1/2 NPT	1.875"	0.500"	1 1/8"	3000
1" X 1/2"	RN8X1/2 NPT	2.093"	0.500"	1 3/8"	3000
1" X 3/4"	RN8X3/4 NPT	2.093"	0.718"	1 3/8"	3000

HIGH PRESSURE PRECISION PIPE FITTINGS

Hexagon Reducing Coupling NPT

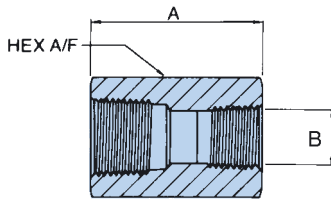

Thread NPT female/female	Part No	A Dim.	B Dia.	Hex A/F	WP psi
1/4" X 1/8"	HRC2X1/8NPT	1.125"	0.344"	3/4"	6000
3/8" X 1/4"	HRC3X1/4NPT	1.375"	0.422"	7/8"	5000
1/2" X 1/4"	HRC4X1/4NPT	1.750"	0.422"	1 1/6"	4500
1/2" X 3/8"	HRC4X3/8NPT	1.781"	0.562"	1 1/6"	4500
3/4" X 1/4"	HRC6X1/4NPT	1.812"	0.422"	1 5/15"	3300
3/4" X 3/8"	HRC6X3/8NPT	1.937"	0.562"	1 5/16"	3300
3/4" X 1/2"	HRC6X1/2NPT	2.062"	0.687"	1 5/16"	3300
1" X 1/2"	HRC8X1/2NPT	2.187"	0.687"	1 11/16"	4000
1" X 3/4"	HRC8X3/4NPT	2.250"	0.890"	1 11/16"	4000

High Pressure Reducing Bush NPT

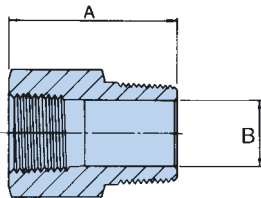

Thread NPT male/female	Part No	A Dim.	B Dia.	Hex A/F	WP psi
1/4" X 1/8"	HPRB2X1/8NPT	1.062"	0.281"	9/16"	6000
3/8" X 1/8"	HPRB3X1/8NPT	0.812"	0.328"	11/16"	6000
3/8" X 1/4"	HPRB3X1/4NPT	0.812"	0.437"	11/16"	6000
1/2" X 1/4"	HPRB4X1/4NPT	1.031"	0.437"	7/8"	6000
1/2" X 3/8"	HPRB4X3/8NPT	1.406"	0.500"	7/8"	6000
3/4" X 1/4"	HPRB6X1/4NPT	1.125"	0.437"	1 1/8"	6000
3/4" X 3/8"	HPRB6X3/8NPT	1.125"	0.562"	1 1/8"	6000
3/4" X 1/2"	HPRB6X1/2NPT	1.125"	0.703"	1 1/8"	4500
1" X 1/4"	HPRB8X1/4NPT	1.312"	0.437"	1 3/8"	5000
1" X 3/8"	HPRB8X3/8NPT	1.312"	0.562"	1 3/8"	5000
1" X 1/2"	HPRB8X1/2NPT	1.312"	0.703"	1 3/8"	4500
1" X 3/4"	HPRB8X3/4NPT	1.750"	0.875"	1 3/8"	3300

Reducing Bush NPT

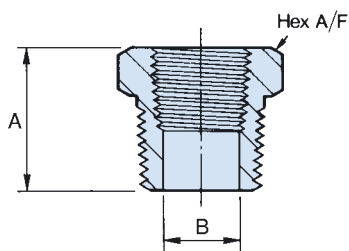

Thread NPT male/female	Part No	A Dim.	B Dia.	Hex A/F	WP psi
1/4" X 1/8"	RB2X1/8NPT	0.750"	0.197"	0.562"	3000
3/8" X 1/8"	RB3X1/8NPT	0.812"	0.197"	0.750"	3000
3/8" X 1/4"	RB3X1/4NPT	0.812"	0.250"	0.750"	3000
1/2" X 1/4"	RB4X1/4NPT	1.000"	0.250"	0.875"	3000
1/2" X 3/8"	RB4X3/8NPT	1.000"	0.375"	0.875"	3000
3/4" X 1/4"	RB6X1/4NPT	1.125"	0.250"	1.125"	3000
3/4" X 3/8"	RB6X3/8NPT	1.125"	0.375"	1.125"	3000
3/4" X 1/2"	RB6X1/2NPT	1.125"	0.500"	1.125"	3000
1" X 1/2"	RB8X1/2NPT	1.250"	0.500"	1.375"	3000
1" X 3/4"	RB8X3/4NPT	1.250"	0.687"	1.375"	3000
1 1/4" X 3/4"	RB10X3/4NPT	1.343"	0.687"	1.750"	3000
1 1/4" X 1"	RB10X1NPT	1.343"	0.875"	1.750"	3000
1 1/2" X 3/4"	RB12X3/4NPT	1.375"	0.687"	2.050"	3000
2" X 1/2"	RB16X1/2NPT	1.500"	0.500"	2.500"	3000
2" x 1"	RB16X1NPT	1.500"	0.875"	2.500"	3000

HIGH PRESSURE PRECISION PIPE FITTINGS

Reducing Bush BSPT

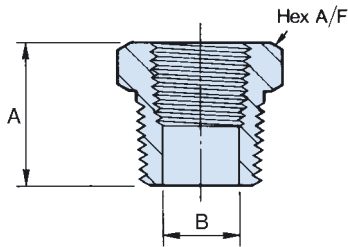

Thread BSPT male/female	Part No	A Dim.	B Dia.	Hex A/F	WP psi
1/4" X 1/8"	RB2X1/8T	0.750"	0.197"	0.562"	3000
3/8" X 1/4"	RB3X1/4T	0.812"	0.250"	0.750"	3000
1/2" X 1/4"	RB4X1/4T	1.000"	0.250"	0.875"	3000
1/2" X 3/8"	RB4X3/8T	1.000"	0.375"	0.875"	3000
3/4" X 1/4"	RB6X1/4T	1.125"	0.250"	1.125"	3000
3/4" X 3/8"	RB6X3/8T	1.125"	0.375"	1.125"	3000
3/4" X 1/2"	RB6X1/2T	1.125"	0.500"	1.125"	3000
1" X 1/4"	RB8X1/4T	1.250"	0.250"	1.375"	3000
1" X 3/8"	RB8X3/8T	1.250"	0.375"	1.375"	3000
1" X 1/2"	RB8X1/2T	1.250"	0.500"	1.375"	3000
1" X 3/4"	RB8X3/4T	1.250"	0.687"	1.375"	3000

PLEASE SEE THE LOW PRESSURE SECTION FOR LARGER SIZES

Tapered Plug

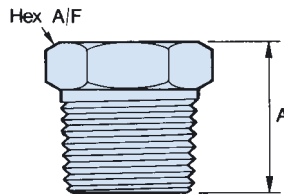

Thread BSPT	Part No	A Dim.	Hex A/F	WP (psi)
1/8"	TP1	0.562"	7/16"	6000
1/4"	TP2	0.718"	9/16"	6000
3/8"	TP3	0.781"	11/16"	6000
1/2"	TP4	0.937"	7/8"	6000
3/4"	TP6	1.125"	1 1/8"	6000
1"	TP8	1.250"	1 3/8"	5000
1 1/4"	TP10	1.406"	1 11/16"	3000
1 1/2"	TP12	1.437"	2.050"	3000
2"	TP16	1.531"	2 1/2"	3000

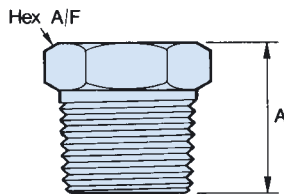

Thread NPT	Part No	A Dim.	Hex A/F	WP (psi)
1/8"	TP1 NPT	0.625"	7/16"	6000
1/4"	TP2 NPT	0.812"	9/16"	6000
3/8"	TP3 NPT	0.843"	11/16"	6000
1/2"	TP4 NPT	1.062"	7/8"	6000
3/4"	TP6 NPT	1.125"	1 1/8"	6000
1"	TP8 NPT	1.312"	1 3/8"	5000
1 1/4"	TP10 NPT	1.375"	1 11/16"	3000
1 1/2"	TP12 NPT	1.437"	2.050"	3000
2"	TP16 NPT	1.531"	2 1/2"	3000

Square Head Plug

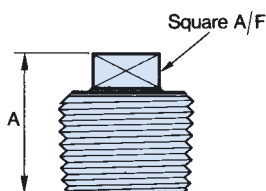

Thread BSPT	Part No	A Dim.	Sq. A/F	WP (psi)
1/8"	SH1	0.611"	0.236"	6000
1/4"	SH2	0.750"	0.375"	6000
3/8"	SH3	0.875"	0.437"	6000
1/2"	SH4	0.937"	0.562"	6000
3/4"	SH6	1.125"	0.625"	6000
1"	SH8	1.200"	0.687"	5000

HIGH PRESSURE PRECISION PIPE FITTINGS

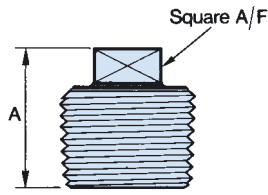

Thread	Part No	A Dim.	Sq. A/F	WP (psi)
NPT				
1/8"	SH1 NPT	0.630"	0.275"	6000
1/4"	SH2 NPT	0.669"	0.394"	6000
3/8"	SH3 NPT	0.827"	0.437"	6000
1/2"	SH4 NPT	0.945"	0.551"	6000
3/4"	SH6 NPT	1.062"	0.630"	6000
1"	SH8 NPT	1.260"	0.825"	5000

Socket Head Plug

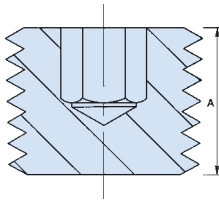

Thread	Part No	A Dim.	WP (psi)
BSPT			
1/8"	SHP1T	0.276"	6000
1/4"	SHP2T	0.433"	6000
3/8"	SHP3T	0.449"	6000
1/2"	SHP4T	0.591"	6000

Thread	Part No	A Dim.	WP (psi)
NPT			
1/8"	SHP1N	0.276"	6000
1/4"	SHP2N	0.433"	6000
3/8"	SHP3N	0.449"	6000
1/2"	SHP4N	0.591"	6000

Vent Plug

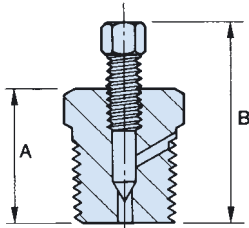

Thread	Part No	A Dim.	B Dim.	WP (psi)
BSPT				
1/4"	VP2	0.812"	1.210"	6000
1/2"	VP4	1.250"	1.703"	6000

Thread	Part No	A Dim.	B Dim.	WP (psi)
NPT				
1/4"	VP2 NPT	0.812"	1.210"	6000

Straight Adaptor

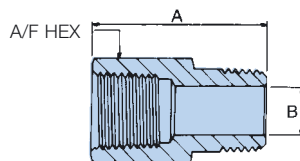

Thread	Part No	A Dim.	B Dia.	Hex A/F	WP psi
NPT					
1/8"	SA1	0.937"	0.156"	9/16"	6000
1/4"	SA2	1.187"	0.218"	3/4"	6000
3/8"	SA3	1.343"	0.343"	7/8"	6000
1/2"	SA4	1.656"	0.437"	1 1/8"	4500
3/4"	SA6	1.906"	0.625"	1 5/16"	3300
1"	SA8	2.156"	0.875"	1 11/16"	4000

HIGH PRESSURE PRECISION PIPE FITTINGS

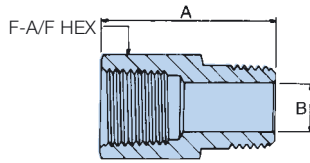

Thread NPT	Part No	A Dim.	B Dia.	Hex A/F	WP psi
1/8"	SA1 NPT	0.890"	0.187"	9/16"	6000
1/4"	SA2 NPT	1.218"	0.281"	3/4"	6000
3/8"	SA3 NPT	1.343"	0.406"	7/8"	6000
1/2"	SA4 NPT	1.718"	0.500"	1 1/8"	4500
3/4"	SA6 NPT	1.750"	0.718"	1 5/16"	3300
1"	SA8 NPT	2.125"	0.875"	1 11/16"	4000

Reducing Adaptor

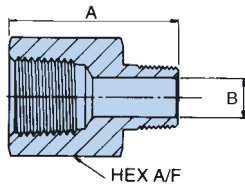

Thread BSPT	Part No	A Dim.	B Dia.	Hex A/F	WP psi
1/4" X 1/8"	RA2/1	1.250"	0.156"	3/4"	6000
3/8" X 1/4"	RA3/2	1.468"	0.218"	7/8"	6000
1/2" X 3/8"	RA4/3	1.750"	0.343"	1 1/8"	6000
3/4" X 1/2"	RA6/4	2.093"	0.437"	1 5/16"	3300
1" X 3/4"	RA8/6	2.281"	0.625"	1 11/16"	4000

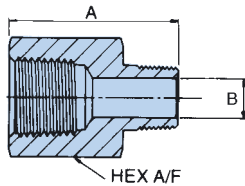

Thread NPT	Part No	A Dim.	B Dia.	Hex A/F	WP psi
1/4" X 1/8"	RA2/1 NPT	1.250"	0.156"	3/4"	6000
3/8" X 1/4"	RA3/2 NPT	1.500"	0.281"	7/8"	6000
1/2" X 3/8"	RA4/3 NPT	1.750"	0.406"	1 1/8"	6000
3/4" X 1/2"	RA6/4 NPT	2.062"	0.500"	1 5/16"	3300
1" X 3/4"	RA8/6 NPT	2.187"	0.718"	1 11/16"	4000

Hexagon Pipe Cap

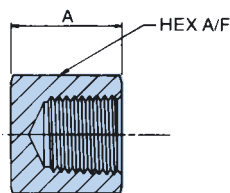

Thread NPT	Part No	A Dim.	Hex A/F	WP (psi)
1/8"	HPC1 NPT	0.593"	9/16"	6000
1/4"	HPC2 NPT	0.812"	3/4"	6000
3/8"	HPC3 NPT	0.875"	7/8"	6000
1/2"	HPC4 NPT	1.250"	1 1/8"	4500
3/4"	HPC6 NPT	1.328"	1 5/16"	3300
1"	HPC8 NPT	1.593"	1 11/16"	4000

HIGH PRESSURE PRECISION PIPE FITTINGS

Full Coupling

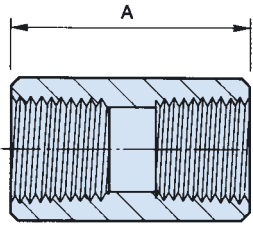

Thread NPT	Part No	A Dim.	Hex A/F	WP (psi)
1/8"	FC1 NPT	1.250"	9/16"	6000
1/4"	FC2 NPT	1.375"	3/4"	6000
3/8"	FC3 NPT	1.500"	7/8"	6000
1/2"	FC4 NPT	1.875"	1 1/8"	4500
3/4"	FC6 NPT	2.000"	1 5/16"	3300
1"	FC8 NPT	2.375"	1 11/16"	4000

Half Coupling

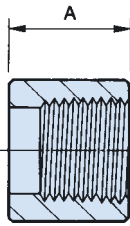

Thread NPT	Part No	A Dim.	Hex A/F	WP (psi)
1/8"	HCP1 NPT	0.625"	9/16"	6000
1/4"	HCP2 NPT	0.687"	3/4"	6000
3/8"	HCP3 NPT	0.750"	7/8"	6000
1/2"	HCP4 NPT	0.937"	1 1/8"	4500
3/4"	HCP6 NPT	1.000"	1 5/16"	3300
1"	HCP8 NPT	1.187"	1 11/16"	4000

High Pressure Female Elbow

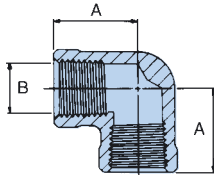

Thread BSPT	Part No	A Dim.	B Dia.	Hex A/F	WP psi
1/8"	HPE1	0.750"	0.328"	1/2"	6000
1/4"	HPE2	0.875"	0.437"	5/8"	6000
3/8"	HPE3	0.875"	0.562"	13/16"	6000
1/2"	HPE4	1.125"	0.703"	1 1/16"	5000
3/4"	HPE6	1.250"	0.906"	1 3/8"	5000

Thread NPT	Part No	A Dim.	B Dia.	Hex A/F	WP psi
1/8"	HPE1 NPT	0.750"	0.328"	1/2"	6000
1/4"	HPE2 NPT	0.875"	0.437"	5/8"	6000
3/8"	HPE3 NPT	0.875"	0.562"	13/16"	6000
1/2"	HPE4 NPT	1.125"	0.703"	1 1/16"	5000
3/4"	HPE6 NPT	1.250"	0.906"	1 3/8"	5000

Male Elbow

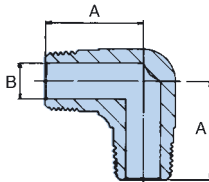

Thread BSPT	Part No	A Dim.	B Dia.	Hex A/F	WP psi
1/8"	ME1	0.687"	0.156"	3/8"	6000
1/4"	ME2	0.906"	0.218"	5/8"	6000
3/8"	ME3	1.000"	0.343"	13/16"	6000
1/2"	ME4	1.312"	0.437"	1 1/16"	5000
3/4"	ME6	1.437"	0.625"	1 1/16"	5000

Thread NPT	Part No	A Dim.	B Dia.	Hex A/F	WP psi
1/8"	ME1 NPT	0.687"	0.187"	3/8"	6000
1/4"	ME2 NPT	1.000"	0.281"	5/8"	6000
3/8"	ME3 NPT	1.062"	0.406"	13/16"	6000
1/2"	ME4 NPT	1.437"	0.500"	1 1/16"	5000
3/4"	ME6 NPT	1.437"	0.718"	1 1/16"	5000

HIGH PRESSURE PRECISION PIPE FITTINGS

High Pressure Female Tee

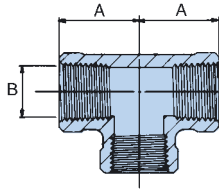

Thread	Part No	A Dim.	B Dia.	Hex A/F	WP psi
BSPT					
1/8"	HPT1	0.750"	0.328"	1/2"	6000
1/4"	HPT2	0.875"	0.437"	5/8"	6000
3/8"	HPT3	0.875"	0.562"	13/16"	6000
1/2"	HPT4	1.125"	0.703"	1 1/16"	5000
3/4"	HPT6	1.250"	0.906"	1 3/8"	5000

Thread Part No

Thread	Part No	A Dim.	B Dia.	Hex A/F	WP psi
NPT					
1/8"	HPT1 NPT	0.750"	0.328"	1/2"	6000
1/4"	HPT2 NPT	0.875"	0.437"	5/8"	6000
3/8"	HPT3 NPT	0.875"	0.562"	13/16"	6000
1/2"	HPT4 NPT	1.125"	0.703"	1 1/16"	5000
3/4"	HPT6 NPT	1.250"	0.906"	1 3/8"	5000

Male Tee

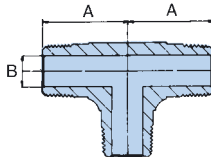

Thread Part No

Thread	Part No	A Dim.	B Dia.	Hex A/F	WP psi
BSPT					
1/8"	MT1	0.687"	0.156"	3/8"	6000
1/4"	MT2	0.906"	0.218"	5/8"	6000
3/8"	MT3	1.000"	0.343"	13/16"	6000
1/2"	MT4	1.312"	0.437"	1 1/16"	5000
3/4"	MT6	1.437"	0.625"	1 1/16"	5000

Thread Part No

Thread	Part No	A Dim.	B Dia.	Hex A/F	WP psi
NPT					
1/8"	MT1 NPT	0.687"	0.156"	3/8"	6000
1/4"	MT2 NPT	0.906"	0.218"	5/8"	6000
3/8"	MT3 NPT	1.000"	0.343"	13/16"	6000
1/2"	MT4 NPT	1.312"	0.437"	1 1/16"	5000
3/4"	MT6 NPT	1.437"	0.625"	1 1/16"	5000

BSP parallel reducing socket 150lb class

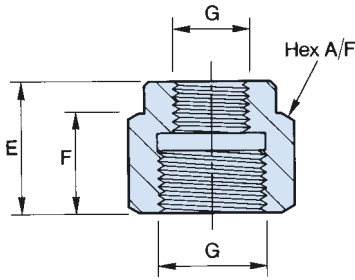

thread size G	part number	E	F	hex A/F	
1/4" BSP	1/8" BSP	RS2	0.900"	0.700"	0.750"
3/8" BSP	1/4" BSP	RS3	0.980"	0.780"	0.875"
1/2" BSP	1/4" BSP	RS4/2	1.050"	0.850"	1.125"
1/2" BSP	3/8" BSP	RS4	1.130"	0.850"	1.125"
3/4" BSP	1/2" BSP	RS6	1.350"	1.000"	1.300"
1" BSP	1/2" BSP	RS8/4	1.400"	1.000"	1.670"
1" BSP	3/4" BSP	RS8	1.550"	1.050"	1.670"
1 1/4" BSP	1" BSP	RS10	1.600"	1.050"	2.050"
1 1/2" BSP	1 1/4" BSP	RS12	1.700"	1.150"	2.220"
2" BSP	1 1/2" BSP	RS16	1.900"	1.250"	2.750"

BSP parallel welding boss 150lb class

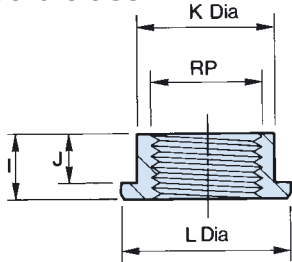

thread size G	part number	I	J	K Dia	L Dia
1/8" BSP	B1	0.312"	0.325"	0.532"	0.625"
1/4" BSP	B2	0.450"	0.325"	0.750"	0.875"
3/8" BSP	B3	0.530"	0.405"	0.875"	1.062"
1/2" BSP	B4	0.600"	0.475"	1.000"	1.125"
3/4" BSP	B6	0.625"	0.562"	1.250"	1.500"
1" BSP	B8	0.800"	0.550"	1.750"	2.000"

BSP parallel - NPTF screwed bush 150lb class

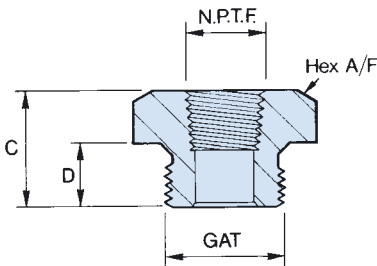

thread size external GAT	internal NPTF	part number	C	D	hex A/F
1/4" BSP	1/8" NPTF	SB2/1N	0.700"	0.450"	0.750"
3/8" BSP	1/8" NPTF	SB3/1N	0.780"	0.530"	0.875"
3/8" BSP	1/4" NPTF	SB3/2N	0.780"	0.530"	0.875"
1/2" BSP	1/8" NPTF	SB4/1N	1.000"	0.625"	1.125"
1/2" BSP	1/4" NPTF	SB4/2N	1.000"	0.625"	1.125"
1/2" BSP	3/8" NPTF	SB4/3N	1.000"	0.625"	1.125"
3/4" BSP	1/4" NPTF	SB6/2N	1.125"	0.750"	1.300"
3/4" BSP	3/8" NPTF	SB6/3N	1.125"	0.750"	1.300"
3/4" BSP	1/2" NPTF	SB6/4N	1.125"	0.750"	1.300"
1" BSP	1/4" NPTF	SB8/2N	1.175"	0.800"	1.670"
1" BSP	3/8" NPTF	SB8/3N	1.175"	0.800"	1.670"
1" BSP	1/2" NPTF	SB8/4N	1.175"	0.800"	1.670"
1" BSP	3/4" NPTF	SB8/6N	1.175"	0.800"	1.670"

BSP parallel screwed bush 150lb class

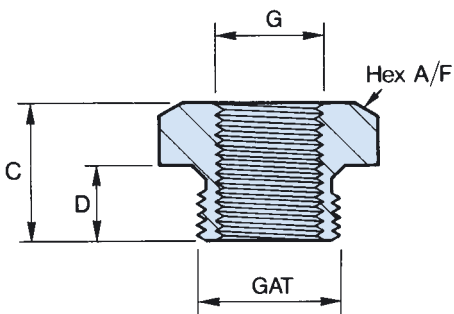

thread size external GAT	internal G	part number	C	D	hex A/F
1/4" BSP	1/8" BSP	SB2	0.700"	0.450"	0.750"
3/8" BSP	1/8" BSP	SB3/1	0.780"	0.530"	0.875"
3/8" BSP	1/4" BSP	SB3	0.780"	0.530"	0.875"
1/2" BSP	1/8" BSP	SB4/1	1.000"	0.625"	1.125"
1/2" BSP	1/4" BSP	SB4/2	1.000"	0.625"	1.125"
1/2" BSP	3/8" BSP	SB4	1.000"	0.625"	1.125"
3/4" BSP	1/8" BSP	SB6/1	1.125"	0.750"	1.300"
3/4" BSP	1/4" BSP	SB6/2	1.125"	0.750"	1.300"
3/4" BSP	3/8" BSP	SB6/3	1.125"	0.750"	1.300"
3/4" BSP	1/2" BSP	SB6	1.125"	0.750"	1.300"
1" BSP	1/4" BSP	SB8/2	1.175"	0.800"	1.670"
1" BSP	3/8" BSP	SB8/3	1.175"	0.800"	1.670"
1" BSP	1/2" BSP	SB8/4	1.175"	0.800"	1.670"
1" BSP	3/4" BSP	SB8	1.175"	0.800"	1.670"
1 1/4" BSP	3/4" BSP	SB10/6	1.237"	0.800"	2.050"
1 1/4" BSP	1" BSP	SB10	1.237"	0.800"	2.050"
1 1/2" BSP	1" BSP	SB12/8	1.287"	0.900"	2.220"
1 1/2" BSP	1 1/4" BSP	SB12	1.287"	0.900"	2.220"
2" BSP	1" BSP	SB16/8	1.437"	1.000"	2.750"
2" BSP	1 1/2" BSP	SB16	1.437"	1.000"	2.750"

BSP parallel hexagon plug 3000lb class

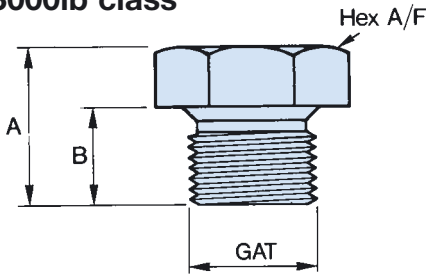

thread size GAT	part number	A	B	hex A/F
1/8" BSP	P1	0.570"	0.350"	0.562"
1/4" BSP	P2	0.700"	0.450"	0.750"
3/8" BSP	P3	0.780"	0.530"	0.875"
1/2" BSP	P4	1.000"	0.625"	1.125"
3/4" BSP	P6	1.125"	0.750"	1.300"
1" BSP	P8	1.175"	0.800"	1.670"
1 1/4" BSP	P10	1.237"	0.800"	2.050"
1 1/2" BSP	P12	1.287"	0.900"	2.220"
2" BSP	P16	1.437"	1.000"	2.750"

BSP Parallel Plugs can be drilled and tapped to convert into Screwed Bushes to order

BSP parallel plug coned 3000lb class

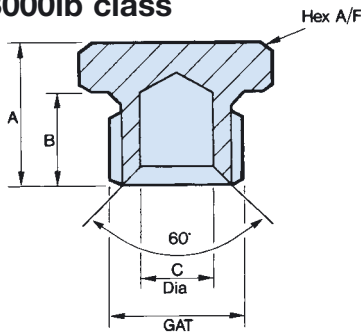

thread size GAT	part number	A	B	C dia	hex A/F
1/8" BSP	P1 coned	0.570"	0.350"	0.125"	0.562"
1/4" BSP	P2 coned	0.700"	0.450"	0.250"	0.750"
3/8" BSP	P3 coned	0.780"	0.530"	0.375"	0.875"
1/2" BSP	P4 coned	1.000"	0.625"	0.500"	1.125"

BSP parallel hexagon cap 3000lb class

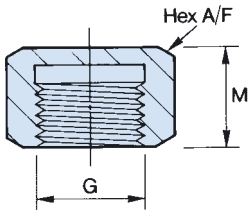

thread size G	part number	M	Hex A/F
1/8" BSP	HC1	0.500"	0.562"
1/4" BSP	HC2	0.500"	0.750"
3/8" BSP	HC3	0.593"	0.875"
1/2" BSP	HC4	0.750"	1.125"
3/4" BSP	HC6	0.870"	1.300"
1" BSP	HC8	0.937"	1.670"
1 1/2" BSP	HC12	1.500"	2.220"

BSP parallel screw seal assembly 3000lb class

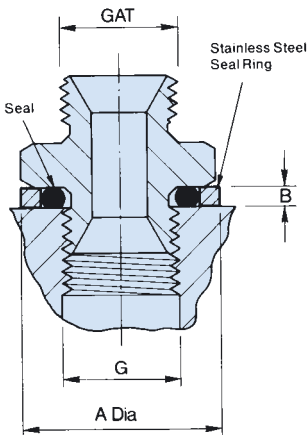

Stainless seal ring with PTFE seal

thread size GAT/G	part number	A dia	B
1/8" BSP	SR1PT	0.625"	0.056"
1/4" BSP	SR2PT	0.875"	0.056"
3/8" BSP	SR3PT	1.000"	0.056"
1/2" BSP	SR4PT	1.250"	0.086"
3/4" BSP	SR6PT	1.500"	0.086"
1" BSP	SR8PT	1.750"	0.086"
1 1/4" BSP	SR10PT	2.375"	0.115"
1 1/2" BSP	SR12PT	2.525"	0.115"
2" BSP	SR16PT	3.125"	0.115"

Stainless seal ring with nitrile seal

thread size GAT/G	part number	A dia	B
1/8" BSP	SR1NT	0.625"	0.056"
1/4" BSP	SR2NT	0.875"	0.056"
3/8" BSP	SR3NT	1.000"	0.056"
1/2" BSP	SR4NT	1.250"	0.086"
3/4" BSP	SR6NT	1.500"	0.086"
1" BSP	SR8NT	1.750"	0.086"
1 1/4" BSP	SR10NT	2.375"	0.115"
1 1/2" BSP	SR12NT	2.525"	0.115"
2" BSP	SR16NT	3.125"	0.115"

Stainless seal rings only



thread size	part number
1/8" BSP	SR1
1/4" BSP	SR2
3/8" BSP	SR3
1/2" BSP	SR4
3/4" BSP	SR6
1" BSP	SR8
1 1/4" BSP	SR10
1 1/2" BSP	SR12
2" BSP	SR16

PTFE seals only



thread size	part number
1/8" BSP	OR1PT
1/4" BSP	OR2PT
3/8" BSP	OR3PT
1/2" BSP	OR4PT
3/4" BSP	OR6PT
1" BSP	OR8PT
1 1/4" BSP	OR10PT
1 1/2" BSP	OR12PT
2" BSP	OR16PT

Nitrile seals only

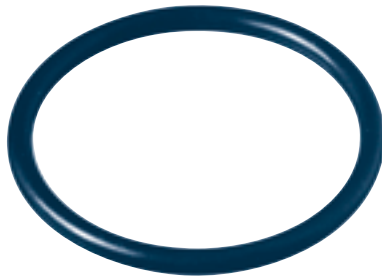

thread size	part number
1/8" BSP	OR1
1/4" BSP	OR2
3/8" BSP	OR3
1/2" BSP	OR4
3/4" BSP	OR6
1" BSP	OR8
1 1/4" BSP	OR10
1 1/2" BSP	OR12
2" BSP	OR16

Square hose adaptors
page 5.10

Hose adaptor 60° cone
page 5.09

Union nut
page 5.09

Female hose union assembly

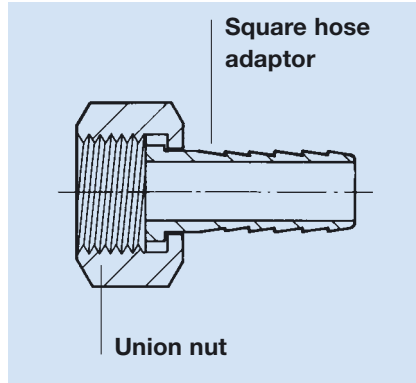

Female hose union assembly 60° cone

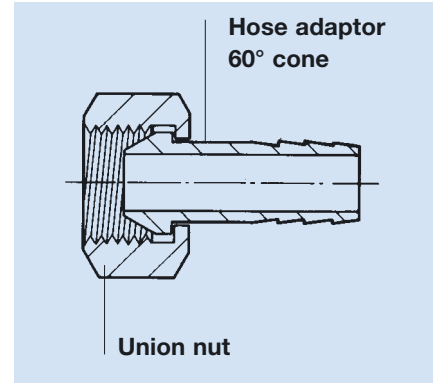

Female hose union assembly finger tight

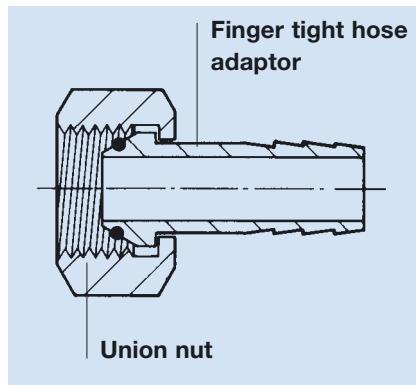

Hose to hose connector

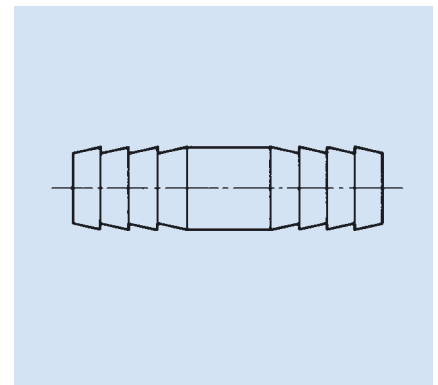

Finger tight hose adaptor
page 5.10

OD tube to hose coupling

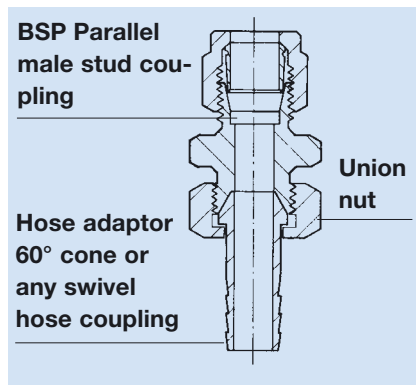

Male tube union assembly

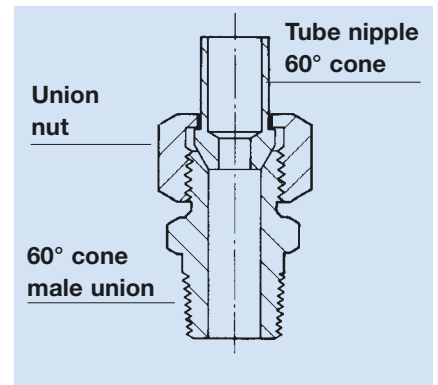

BSP parallel male stud coupling single or double ferrule option
section 1

Tube nipple 60° cone
page 5.09

60° cone male union
page 5.07, 5.09

Hose adaptor 60° cone
page 5.09

BSP – BSPT male union 3000lb class

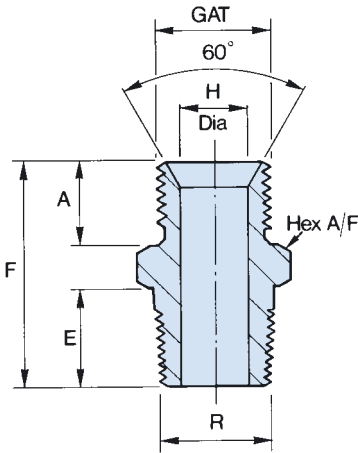

thread size GAT	thread size R	part number	A	E	F	H dia	hex A/F
1/8" BSP	1/8" BSPT	U1/N1	0.450"	0.375"	1.075"	0.125"	0.562"
1/4" BSP	1/8" BSPT	U2/N1	0.450"	0.375"	1.075"	0.197"	0.750"
1/4" BSP	1/4" BSPT	U2/N2	0.450"	0.500"	1.200"	0.250"	0.750"
1/4" BSP	3/8" BSPT	U2/N3	0.450"	0.562"	1.262"	0.250"	0.875"
1/4" BSP	1/2" BSPT	U2/N4	0.450"	0.687"	1.324"	0.250"	1.125"
3/8" BSP	1/8" BSPT	U3/N1	0.530"	0.375"	1.155"	0.197"	0.875"
3/8" BSP	1/4" BSPT	U3/N2	0.530"	0.500"	1.280"	0.250"	0.875"
3/8" BSP	3/8" BSPT	U3/N3	0.530"	0.562"	1.342"	0.375"	0.875"
3/8" BSP	1/2" BSPT	U3/N4	0.530"	0.687"	1.529"	0.375"	1.125"
1/2" BSP	1/4" BSPT	U4/N2	0.600"	0.500"	1.412"	0.250"	1.125"
1/2" BSP	3/8" BSPT	U4/N3	0.600"	0.562"	1.474"	0.375"	1.125"
1/2" BSP	1/2" BSPT	U4/N4	0.600"	0.687"	1.599"	0.500"	1.125"
1/2" BSP	3/4" BSPT	U4/N6	0.600"	0.750"	1.725"	0.500"	1.125"
1/2" BSP	1" BSPT	U4/N8	0.600"	0.875"	1.850"	0.500"	1.375"
3/4" BSP	1/2" BSPT	U6/N4	0.750"	0.687"	1.812"	0.500"	1.300"
3/4" BSP	3/4" BSPT	U6/N6	0.750"	0.750"	1.875"	0.687"	1.300"
3/4" BSP	1" BSPT	U6/N8	0.750"	0.875"	2.000"	0.687"	1.375"
1" BSP	1/2" BSPT	U8/N4	0.800"	0.687"	1.862"	0.500"	1.670"
1" BSP	3/4" BSPT	U8/N6	0.800"	0.750"	1.925"	0.687"	1.670"
1" BSP	1" BSPT	U8/N8	0.800"	0.875"	2.050"	0.875"	1.670"
1 1/4" BSP	1 1/4" BSPT	U10/N10	0.800"	0.906"	2.143"	1.125"	2.050"
1 1/2" BSP	1 1/2" BSPT	U12/N12	0.900"	0.937"	2.274"	1.375"	2.220"
2" BSP	2" BSPT	U16/N16	1.000"	1.062"	2.499"	1.750"	2.750"

BSP – NPTF male union 3000lb class

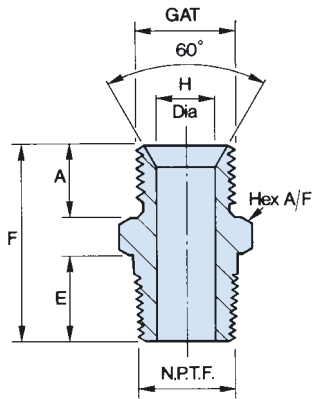

thread size GAT	thread size NPTF	part number	A	E	F	H dia	hex A/F
1/8" BSP	1/8" NPTF	U1/N1N	0.450"	0.375"	1.075"	0.125"	0.562"
1/4" BSP	1/8" NPTF	U2/N1N	0.450"	0.375"	1.075"	0.125"	0.562"
1/4" BSP	1/4" NPTF	U2/N2N	0.450"	0.500"	1.200"	0.250"	0.750"
1/4" BSP	3/8" NPTF	U2/N3N	0.450"	0.562"	1.262"	0.250"	0.750"
1/4" BSP	1/2" NPTF	U2/N4N	0.450"	0.687"	1.449"	0.250"	0.875"
3/8" BSP	1/8" NPTF	U3/N1N	0.530"	0.375"	1.155"	0.125"	0.875"
3/8" BSP	1/4" NPTF	U3/N2N	0.530"	0.500"	1.280"	0.250"	0.875"
3/8" BSP	3/8" NPTF	U3/N3N	0.530"	0.562"	1.342"	0.375"	0.875"
1/2" BSP	1/4" NPTF	U4/N2N	0.600"	0.500"	1.412"	0.250"	1.125"
1/2" BSP	3/8" NPTF	U4/N3N	0.600"	0.562"	1.474"	0.375"	1.125"
1/2" BSP	1/2" NPTF	U4/N4N	0.600"	0.687"	1.599"	0.500"	1.125"
1/2" BSP	3/4" NPTF	U4/N6N	0.600"	0.750"	1.725"	0.500"	1.300"
1/2" BSP	1" NPTF	U4/N8N	0.600"	0.875"	1.850"	0.500"	1.375"
3/4" BSP	1/2" NPTF	U6/N4N	0.750"	0.687"	1.812"	0.500"	1.300"
3/4" BSP	3/4" NPTF	U6/N6N	0.750"	0.750"	1.875"	0.687"	1.300"
1" BSP	1/2" NPTF	U8/N4N	0.800"	0.687"	1.862"	0.500"	1.670"
1" BSP	3/4" NPTF	U8/N6N	0.800"	0.750"	1.925"	0.687"	1.670"
1" BSP	1" NPTF	U8/N8N	0.800"	0.875"	2.050"	0.875"	1.670"
1 1/4" BSP	1 1/4" NPTF	U10/N10N	0.800"	0.906"	2.143"	1.125"	2.050"
1 1/2" BSP	1 1/2" NPTF	U12/N12N	0.900"	0.937"	2.274"	1.375"	2.220"
2" BSP	2" NPTF	U16/N16N	1.000"	1.062"	2.500"	1.500"	2.750"

BSP – BSPP male union 3000lb class

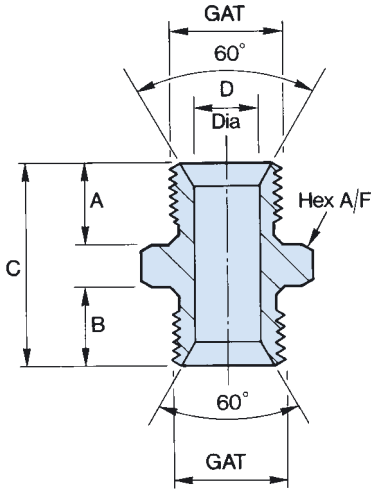

thread size GAT		part number	A	B	C	D dia	hex A/F
1/8" BSP	1/8" BSP	U1	0.450"	0.450"	1.150"	0.125"	0.562"
1/4" BSP	1/8" BSP	U2R	0.450"	0.450"	1.150"	0.125"	0.750"
1/4" BSP	1/4" BSP	U2	0.450"	0.450"	1.150"	0.250"	0.750"
3/8" BSP	1/8" BSP	U3R/1	0.530"	0.450"	1.230"	0.125"	0.875"
3/8" BSP	1/4" BSP	U3R	0.530"	0.450"	1.230"	0.250"	0.875"
3/8" BSP	3/8" BSP	U3	0.530"	0.530"	1.312"	0.375"	0.875"
1/2" BSP	1/4" BSP	U4R/2	0.600"	0.450"	1.362"	0.250"	1.125"
1/2" BSP	3/8" BSP	U4R	0.600"	0.530"	1.442"	0.375"	1.125"
1/2" BSP	1/2" BSP	U4	0.600"	0.600"	1.512"	0.500"	1.125"
5/8" BSP	5/8" BSP	U5	0.625"	0.625"	1.562"	0.531"	1.125"
3/4" BSP	3/8" BSP	U6R/3	0.750"	0.530"	1.655"	0.375"	1.300"
3/4" BSP	1/2" BSP	U6R	0.750"	0.600"	1.725"	0.500"	1.300"
3/4" BSP	5/8" BSP	U6R/5	0.750"	0.625"	1.750"	0.531"	1.300"
3/4" BSP	3/4" BSP	U6	0.750"	0.750"	1.875"	0.687"	1.300"
1" BSP	3/8" BSP	U8R/3	0.800"	0.530"	1.705"	0.375"	1.670"
1" BSP	1/2" BSP	U8R/4	0.800"	0.600"	1.775"	0.500"	1.670"
1" BSP	3/4" BSP	U8R	0.800"	0.750"	1.925"	0.687"	1.670"
1" BSP	1" BSP	U8	0.800"	0.800"	1.975"	0.875"	1.670"
1 1/4" BSP	1" BSP	U10R	0.800"	0.800"	2.037"	0.875"	2.050"
1 1/4" BSP	1 1/4" BSP	U10	0.800"	0.800"	2.037"	1.125"	2.050"
1 1/2" BSP	3/4" BSP	U12R/6	0.900"	0.750"	2.087"	0.687"	2.220"
1 1/2" BSP	1" BSP	U12R/8	0.900"	0.800"	2.137"	0.875"	2.220"
1 1/2" BSP	1 1/4" BSP	U12R	0.900"	0.800"	2.137"	1.125"	2.220"
1 1/2" BSP	1 1/2" BSP	U12	0.900"	0.900"	2.237"	1.375"	2.220"
2" BSP	1" BSP	U16R/8	1.000"	0.800"	2.237"	0.875"	2.750"
2" BSP	1 1/4" BSP	U16R/10	1.000"	0.800"	2.237"	1.125"	2.750"
2" BSP	1 1/2" BSP	U16R	1.000"	0.900"	2.337"	1.375"	2.750"
2" BSP	2" BSP	U16	1.000"	1.000"	2.437"	1.750"	2.750"

BSPP – bulkhead union 3000lb class with hexagon back nut

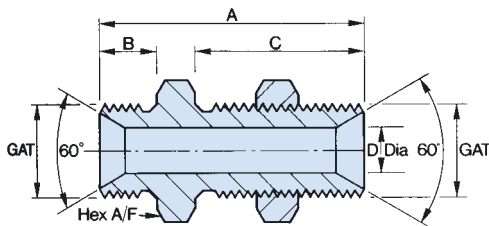

thread size GAT	part number	A	B	C	D dia	hex A/F	bulkhead bore dia
1/4"	BU2	2.125"	0.450"	1.400"	0.250"	0.750"	0.520"
3/8"	BU3	2.192"	0.550"	1.410"	0.375"	0.875"	0.656"
1/2"	BU4	2.350"	0.600"	1.500"	0.510"	1.125"	0.828"
3/4"	BU6	2.875"	0.750"	1.750"	0.760"	1.300"	1.032"
1"	BU8	2.975"	0.800"	1.800"	0.875"	1.670"	1.312"
1 1/2"	BU12	3.310"	0.900"	1.900"	1.310"	2.220"	1.990"

BSPP – union nut 3000lb class

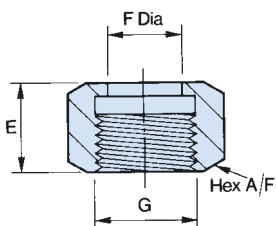

thread size G	part number	E	F dia	hex A/F
1/8" BSP	UN1	0.500"	0.250"	0.562"
1/4" BSP	UN2	0.500"	0.365"	0.750"
3/8" BSP	UN3	0.593"	0.490"	0.875"
1/2" BSP	UN4	0.750"	0.610"	1.125"
3/4" BSP	UN6	0.750"	0.870"	1.300"
1" BSP	UN8	0.937"	1.100"	1.670"
1 1/4" BSP	UN10	1.000"	1.390"	2.050"
1 1/2" BSP	UN12	1.125"	1.650"	2.220"
2" BSP	UN16	1.375"	2.125"	2.750"

BSPT male hose adaptor

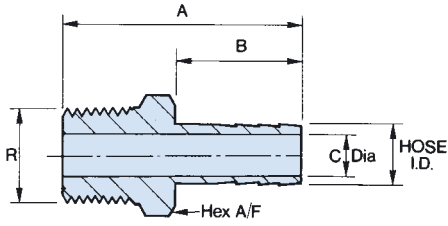

thread size R	hose ID	part number	A	B	C dia	hex A/F
1/8" BSPT	1/4"	MH2/1T	1.625"	1.000"	0.188"	0.437"
1/4" BSPT	1/4"	MH2T	1.750"	1.000"	0.188"	0.562"
1/4" BSPT	3/8"	MH3/2T	1.812"	1.062"	0.188"	0.562"
3/8" BSPT	3/8"	MH3T	1.875"	1.062"	0.312"	0.750"
1/4" BSPT	1/2"	MH4/2T	1.875"	1.125"	0.188"	0.562"
3/8" BSPT	1/2"	MH4/3T	1.937"	1.125"	0.312"	0.750"
1/2" BSPT	1/2"	MH4T	2.125"	1.125"	0.406"	0.875"
1/2" BSPT	3/4"	MH6/4T	2.499"	1.500"	0.406"	0.875"
3/4" BSPT	3/4"	MH6T	2.625"	1.500"	0.640"	1.125"
1/2" BSPT	1"	MH8/4T	2.561"	1.562"	0.406"	1.125"
1" BSPT	1"	MH8T	2.812"	1.562"	0.800"	1.375"
1 1/4" BSPT	1 1/4"	MH10T	3.093"	1.750"	1.050"	1.750"
1 1/2" BSPT	1 1/2"	MH12T	3.374"	2.000"	1.281"	2.050"
2" BSPT	2"	MH16T	3.749"	2.250"	1.750"	2.500"

NPTF male hose adaptor

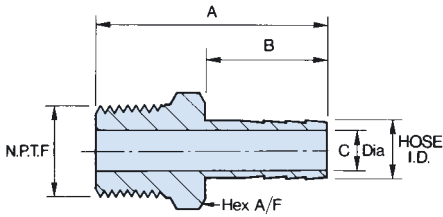

thread size NPTF	hose ID	part number	A	B	C dia	hex A/F
1/8" NPTF	1/4"	MH2/1N	1.625"	1.000"	0.188"	0.437"
1/4" NPTF	1/4"	MH2N	1.750"	1.000"	0.188"	0.562"
1/4" NPTF	3/8"	MH3/2N	1.812"	1.062"	0.188"	0.562"
3/8" NPTF	3/8"	MH3N	1.875"	1.062"	0.312"	0.750"
1/4" NPTF	1/2"	MH4/2N	1.875"	1.125"	0.188"	0.562"
3/8" NPTF	1/2"	MH4/3N	1.937"	1.125"	0.312"	0.750"
1/2" NPTF	1/2"	MH4N	2.125"	1.125"	0.406"	0.875"
3/4" NPTF	3/4"	MH6N	2.625"	1.500"	0.640"	1.125"
1" NPTF	1"	MH8N	2.812"	1.562"	0.800"	1.375"
1 1/4" NPTF	1 1/4"	MH10N	3.093"	1.750"	1.050"	1.750"
1 1/2" NPTF	1 1/2"	MH12N	3.374"	2.000"	1.281"	2.050"
2" NPTF	2"	MH16N	3.749"	2.250"	1.750"	2.500"

BSPP female hose adaptor

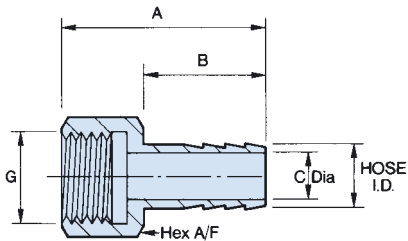

thread size G	hose ID	part number	A	B	C dia	hex A/F
1/4" BSP	1/4"	FH2	1.687"	1.000"	0.188"	0.750"
3/8" BSP	3/8"	FH3	1.750"	1.000"	0.312"	0.875"
1/2" BSP	1/2"	FH4	2.000"	1.125"	0.406"	1.125"

Finger tight hose adaptor

Supplied with nitrile or PTFE O-ring seal
For use with BSP union nut on previous page

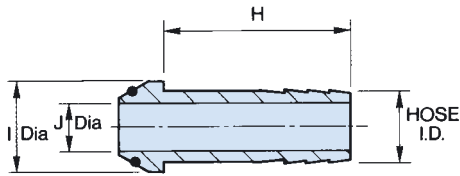

hose ID	part number	H	I dia	J dia
1/4"	FHA2	1.000"	0.437"	0.188"
3/8"	FHA3	1.125"	0.576"	0.312"
1/2"	FHA4	1.312"	0.730"	0.406"
3/4"	FHA6	1.500"	0.950"	0.640"
1"	FHA8	1.562"	1.188"	0.875"

Square hose adaptor

For use with BSP union nut on previous page

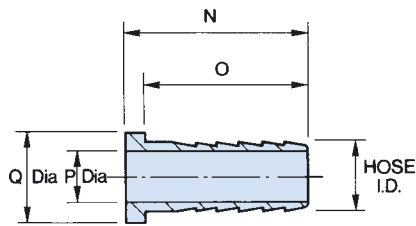

hose ID	part number	N	O	P dia	Q dia
1/4"	SHA2	1.100"	1.000"	0.188"	0.437"
3/8"	SHA3	1.225"	1.125"	0.312"	0.576"
1/2"	SHA4	2.000"	1.812"	0.406"	0.730"
3/4"	SHA6	2.000"	1.812"	0.640"	0.950"
1"	SHA8	2.000"	1.812"	0.800"	1.188"
1 1/4"	SHA10	1.900"	1.750"	1.000"	1.500"
1 1/2"	SHA12	2.275"	2.125"	1.281"	1.750"
2"	SHA16	2.475"	2.250"	1.750"	2.200"

Tube nipple 60° cone

For use with union nut on previous page
To be used for brazing or welding, supplied with O-ring to order

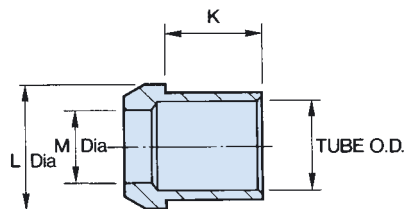

tube OD	part number	K	L dia	M dia
1/8"	TN1	0.250"	0.330"	0.093"
1/4"	TN2	0.320"	0.437"	0.180"
3/8"	TN3	0.400"	0.570"	0.300"
1/2"	TN4	0.550"	0.730"	0.420"
3/4"	TN6	0.790"	0.940"	0.680"
1"	TN8	1.000"	1.180"	0.930"
1 1/4"	TN10	1.250"	1.500"	1.180"
1 1/2"	TN12	1.500"	1.750"	1.420"
2"	TN16	1.650"	2.220"	1.900"

BSP male hose adaptor

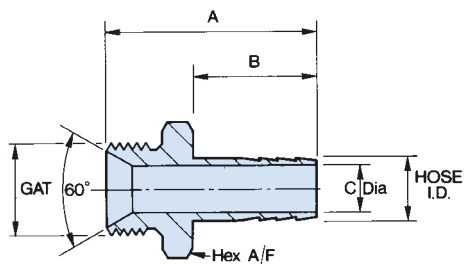

thread size GAT	hose ID	part number	A	B	C dia	hex A/F
1/8" BSP	1/4"	MH2/1	1.700"	1.000"	0.125"	0.750"
1/4" BSP	1/4"	MH2	1.700"	1.000"	0.188"	0.750"
1/4" BSP	3/8"	MH3/2	1.700"	1.000"	0.188"	0.750"
3/8" BSP	3/8"	MH3	1.780"	1.000"	0.312"	0.875"
1/4" BSP	1/2"	MH4/2	1.825"	1.125"	0.188"	0.750"
3/8" BSP	1/2"	MH4/3	1.905"	1.125"	0.312"	0.875"
1/2" BSP	1/2"	MH4	2.000"	1.125"	0.406"	1.125"
1/2" BSP	3/4"	MH6/4	2.412"	1.500"	0.437"	1.125"
3/4" BSP	3/4"	MH6	2.625"	1.500"	0.640"	1.300"
3/4" BSP	1"	MH8/6	2.687"	1.562"	0.687"	1.300"
1" BSP	1"	MH8	2.737"	1.562"	0.875"	1.670"
1 1/4" BSP	1 1/4"	MH10	2.987"	1.750"	1.093"	2.050"
1 1/2" BSP	1 1/2"	MH12	3.375"	2.125"	1.275"	2.220"
2" BSP	2"	MH16	3.687"	2.250"	1.812"	2.750"

Hose adaptor 60° cone

For use with BSP union nut above

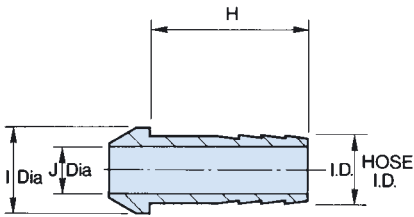

hose ID	part number	H	I dia	J dia
1/4"	HA2	1.000"	0.437"	0.188"
3/8"	HA3	1.125"	0.576"	0.312"
1/2"	HA4	1.312"	0.730"	0.406"
3/4"	HA6	1.500"	0.950"	0.640"
1"	HA8	1.562"	1.188"	0.875"
1 1/4"	HA10	1.750"	1.500"	1.000"
1 1/2"	HA12	2.125"	1.750"	1.281"
2"	HA16	2.250"	2.200"	1.750"

Hose clips 304 stainless steel

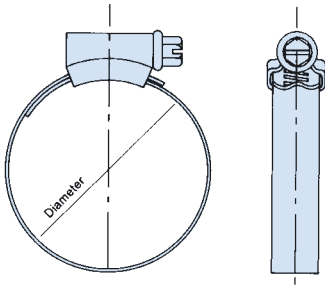

part number	diameter inches
JC 3/4	3/8" - 1/2"
JC 4/6	1/2" - 3/4"
JC 6/8	3/4" - 1"
JC 8/10	1" - 1 1/4"
JC 10/12	1 1/4" - 1 1/2"
JC 12/16	1 1/2" - 2"

150LB SCREWED PIPE FITTINGS 316 STAINLESS STEEL

90 Degree Elbow

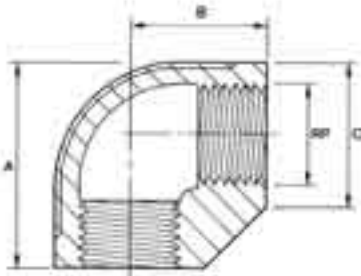

Thread Size BSPP RP	Part Number	Dim A (mm)	Dim B (mm)	Dim C (mm)
1/8"	E1-150	25.5	19	15
1/4"	E2-150	30.5	21	19
3/8"	E3-150	36.5	25	23
1/2"	E4-150	42	28	28
3/4"	E5-150	50	33	34
1"	E6-150	59.5	38	43
1 1/4"	E10-150	71	45	52
1 1/2"	E12-150	78.5	50	57
2"	E16-150	93	58	70

Street Elbow

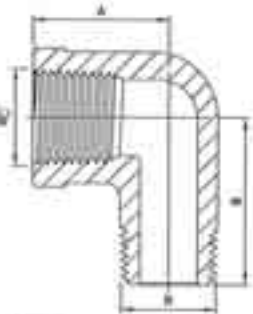

Thread Size BSPT RC x R	Part Number	Dim A (mm)	Dim B (mm)	Dim (mm)
1/8"	SE1-150	17	27	
1/4"	SE2-150	21	28	
3/8"	SE3-150	25	34	
1/2"	SE4-150	28	41	
3/4"	SE5-150	33	46	
1"	SE6-150	38	52	
1 1/4"	SE10-150	43	63	
1 1/2"	SE12-150	48	66	
2"	SE16-150	57	77	

45 Degree Elbow

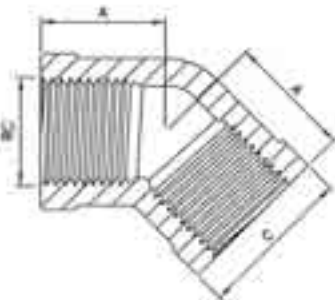

Thread Size BSPT RC	Part Number	Dim A (mm)	Dim C (mm)	Dim (mm)
1/8"	E45/1-150	18	19	
1/4"	E45/2-150	19	19	
3/8"	E45/3-150	21	23	
1/2"	E45/4-150	22	28	
3/4"	E45/6-150	25	37	
1"	E45/8-150	28	45	
1 1/4"	E45/10-150	33	55	
1 1/2"	E45/12-150	36	63	
2"	E45/16-150	43	75	

Equal Tee

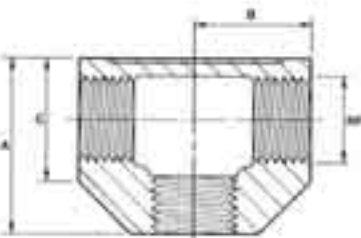

Thread Size BSPP RP	Part Number	Dim A (mm)	Dim B (mm)	Dim C (mm)
1/8"	T1-150	26.5	18	15
1/4"	T2-150	30.5	21	19
3/8"	T3-150	36.5	25	23
1/2"	T4-150	42	28	28
3/4"	T6-150	50	33	34
1"	T8-150	59	38	42
1 1/4"	T10-150	71	45	52
1 1/2"	T12-150	78.5	50	57
2"	T16-150	93	58	70

150LB SCREWED PIPE FITTINGS 316 STAINLESS STEEL

Equal Cross

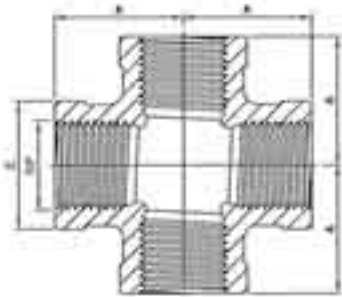

Thread Size BSPP RP	Part Number	Dim A (mm)	Dim C (mm)	Dim (mm)
1/8"	C1-150	19	19	
1/4"	C2-150	21	21	
3/8"	C3-150	25	25	
1/2"	C4-150	28	31	
3/4"	C6-150	33	37	
1"	C8-150	38	45	
1 1/4"	C10-150	45	55	
1 1/2"	C12-150	50	62	
2"	C16-150	58	75	

Hexagon Nipple

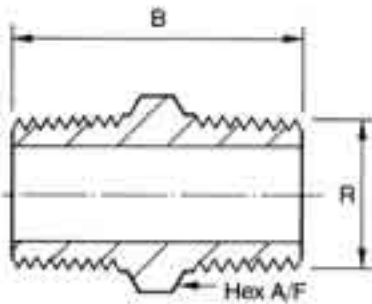

Thread Size BSPT R	Part Number	Dim B (mm)	Dim A/F (mm)	Dim (mm)
1/8"	HN1-150	25	12	
1/4"	HN2-150	32	14	
3/8"	HN3-150	37	20	
1/2"	HN4-150	41	23	
3/4"	HN5-150	46	27	
1"	HN6-150	50	36	
1 1/4"	HN10-150	56	46	
1 1/2"	HN12-150	58	50	
2"	HN16-150	65	65	

Welding Nipple

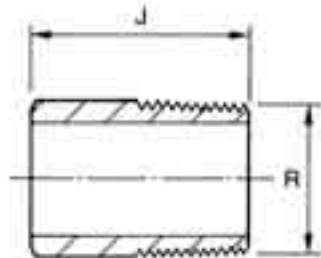

Thread Size BSPT R	Part Number	Dim J (mm)	Dim (mm)	Dim (mm)
1/8"	WN1-150	30		
1/4"	WN2-150	30		
3/8"	WN3-150	30		
1/2"	WN4-150	35		
3/4"	WN6-150	40		
1"	WN6-150	40		
1 1/4"	WN10-150	50		
1 1/2"	WN12-150	50		
2"	WN16-150	50		

Barrel Nipple

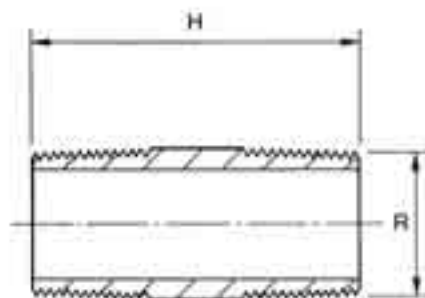

Thread Size BSPT R	Part Number	Dim H (mm)	Dim (mm)	Dim (mm)
1/8"	BN1-150	40		
1/4"	BN2-150	40		
3/8"	BN3-150	40		
1/2"	BN4-150	60		
3/4"	BN6-150	60		
1"	BN6-150	60		
1 1/4"	BN10-150	80		
1 1/2"	BN12-150	80		
2"	BN16-150	100		

150LB SCREWED PIPE FITTINGS 316 STAINLESS STEEL

Parallel Nipple

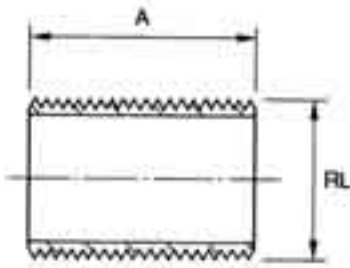

Thread Size BSPP	Part Number	Dim A (mm)	Dim (mm)	Dim (mm)
1/8"	PN1-150	16		
1/4"	PN2-150	18		
3/8"	PN3-150	22		
1/2"	PN4-150	25		
3/4"	PN6-150	30		
1"	PN8-150	35		
1 1/4"	PN10-150	38		
1 1/2"	PN12-150	38		
2"	PN16-150	45		

Full Socket

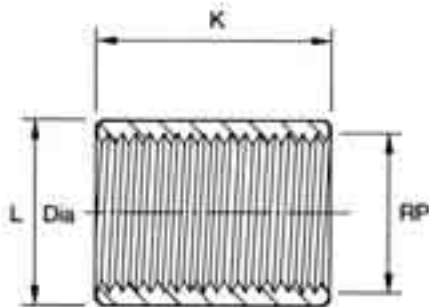

Thread Size BSPP	Part Number	Dim K (mm)	Dim L (mm)	Dim (mm)
1/8"	FS1-150	17	14	
1/4"	FS2-150	25	18	
3/8"	FS3-150	26	22	
1/2"	FS4-150	34	26	
3/4"	FS6-150	36	32	
1"	FS8-150	43	40	
1 1/4"	FS10-150	48	48	
1 1/2"	FS12-150	48	55	
2"	FS16-150	58	66	

Half Socket

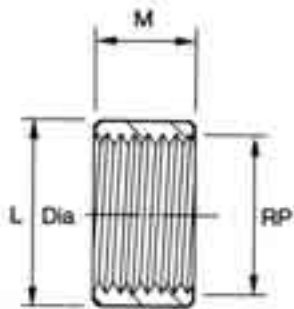

Thread Size BSPP	Part Number	Dim M (mm)	Dim L (mm)	Dim (mm)
1/8"	HS1-150	9	14	
1/4"	HS2-150	12	19	
3/8"	HS3-150	13	22	
1/2"	HS4-150	17	26	
3/4"	HS6-150	18	32	
1"	HS8-150	20	40	
1 1/4"	HS10-150	22	48	
1 1/2"	HS12-150	23	55	
2"	HS16-150	27	66	

Hexagon Head Plug

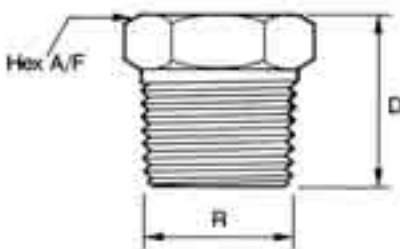

Thread Size BSPT	Part Number	Dim D (mm)	Dim A/F (mm)	Dim (mm)
1/8"	HP1-150	19	12	
1/4"	HP2-150	19	16	
3/8"	HP3-150	19	19	
1/2"	HP4-150	22	23	
3/4"	HP6-150	26	28	
1"	HP8-150	28	36	
1 1/4"	HP10-150	33	46	
1 1/2"	HP12-150	35	50	
2"	HP16-150	39	65	

150LB SCREWED PIPE FITTINGS 316 STAINLESS STEEL

Square Head Plug

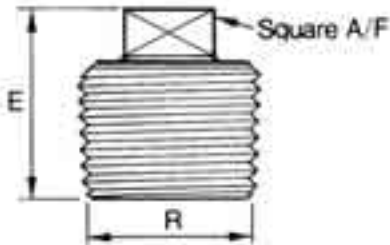

Thread Size BSPT	Part Number	Dim E (mm)	Dim A/F (mm)	Dim (mm)
1/8"	SP1-150	15	7	
1/4"	SP2-150	18	9	
3/8"	SP3-150	20	12	
1/2"	SP4-150	22	14	
3/4"	SP6-150	28	18	
1"	SP8-150	32	19	
1 1/4"	SP10-150	36	23	
1 1/2"	SP12-150	39	26	
2"	SP16-150	45	32	

Union F/F (Cone Seated)

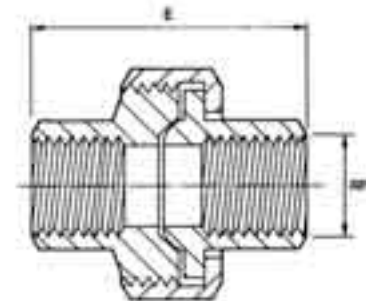

Thread Size BSPP	Part Number	Dim E (mm)	Dim A/F (mm)	Dim (mm)
1/8"	H1-150	40	29	
1/4"	H2-150	42	29	
3/8"	H3-150	45	34	
1/2"	H4-150	48	39	
3/4"	H5-150	52	47	
1"	H6-150	58	58	
1 1/4"	H10-150	65	67	
1 1/2"	H12-150	70	77	
2"	H16-150	78	90	

Union F/F (Flat Type)

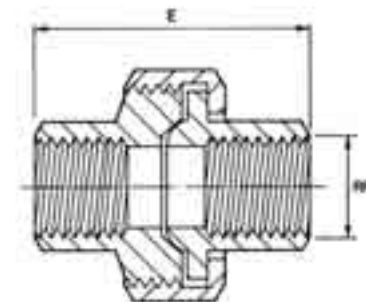

Thread Size BSPP	Part Number	Dim E (mm)	Dim A/F (mm)	Dim (mm)
1/8"	HF1-150	40	29	
1/4"	HF2-150	42	29	
3/8"	HF3-150	45	34	
1/2"	HF4-150	48	39	
3/4"	HF6-150	52	47	
1"	HF8-150	58	58	
1 1/4"	HF10-150	65	67	
1 1/2"	HF12-150	70	77	
2"	HF16-150	78	90	

Hexagon End Cap

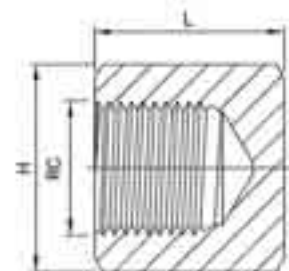

Thread Size BSPT	Part Number	Dim L (mm)	Dim A/F (mm)	Dim (mm)
1/8"	HC1-150	13	15	
1/4"	HC2-150	15	18	
3/8"	HC3-150	18	22	
1/2"	HC4-150	22	26	
3/4"	HC6-150	25	32	
1"	HC8-150	28	39	
1 1/4"	HC10-150	30	48	
1 1/2"	HC12-150	31	54	
2"	HC16-150	38	69	

150LB SCREWED PIPE FITTINGS 316 STAINLESS STEEL

Round End Cap

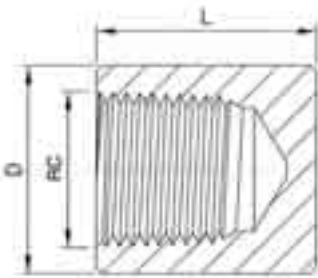

Thread Size BSPT	Part Number	Dim L (mm)	Dim D (mm)	Dim (mm)
RC				
1/8"	EC1-150	17	19	
1/4"	EC2-150	17	21	
3/8"	EC3-150	21	26	
1/2"	EC4-150	23	31	
3/4"	EC6-150	27	37	
1"	EC8-150	33	45	
1 1/4"	EC10-150	41	55	
1 1/2"	EC12-150	41	62	
2"	EC16-150	45	75	

Hexagon Back Nut

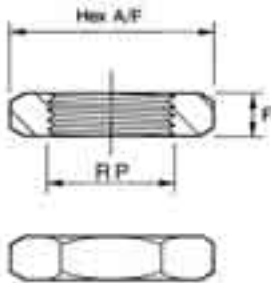

Thread Size BSPP	Part Number	Dim F (mm)	Dim A/F (mm)	Dim (mm)
RP				
1/8"	HBN1-150	6	19	
1/4"	HBN2-150	6	22	
3/8"	HBN3-150	7	27	
1/2"	HBN4-150	8	32	
3/4"	HBN6-150	9	37	
1"	HBN8-150	10	46	
1 1/4"	HBN10-150	11	55	
1 1/2"	HBN12-150	12	62	
2"	HBN16-150	13	76	

Hose Connector (Nipple)

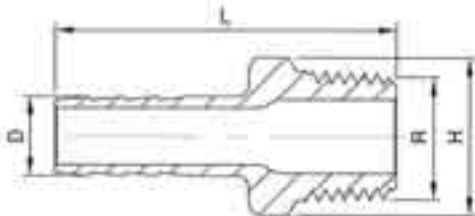

HOSE x BSPT x R	Part Number	Dim L (mm)	Dim H (mm)	Dim D (mm)
1/4" x 1/8"	MH2/1T-150	40	12	7
1/4" x 1/4"	MH2/2T-150	40	15	9
3/8" x 1/4"	MH3/2T-150	40	15	11
1/2" x 1/4"	MH4/2T-150	40	15	11
3/8" x 3/8"	MH3/3T-150	45	19	11
1/2" x 3/8"	MH4/3T-150	50	19	13
1/2" x 1/2"	MH4/4T-150	65	23	13
3/4" x 1/2"	MH6/4T-150	60	23	15
3/4" x 3/4"	MH6/6T-150	63	29	21
1" x 1"	MH8/8T-150	70	38	27
1 1/4" x 1 1/4"	MH10/10T-150	81	46	33
1 1/2" x 1 1/2"	MH12/12T-150	95	52	46
2" x 2"	MH16/16T-150	100	63	57

150LB SCREWED PIPE FITTINGS 316 STAINLESS STEEL

Reducing Adaptor F/M

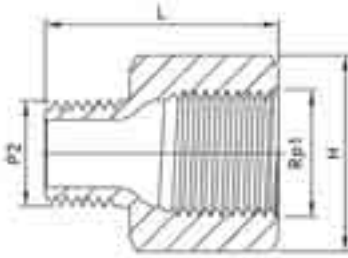

Thread Size BSPT RP1 x P2	Part Number	Dim L (mm)	Dim H (mm)	Dim (mm)
1/4" x 1/8"	RA2/1-150	27	17	
3/8" x 1/4"	RA3/2-150	30	21	
1/2" x 1/4"	RA4/2-150	34	26	
1/2" x 3/8"	RA4/3-150	35	26	
3/4" x 3/8"	RA6/3-150	36	32	
3/4" x 1/2"	RA6/4-150	39	32	
1" x 1/2"	RA8/4-150	42	38	
1" x 3/4"	RA8/6-150	44	38	

Reducing Socket

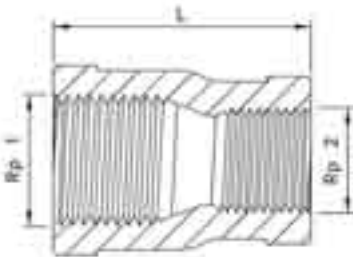

Thread * Size BSPT RP1 x RP2	Part Number	Dim L (mm)	Dim (mm)	Dim (mm)
1/4" x 1/8"	RS2/1-150	27		
3/8" x 1/4"	RS3/2-150	30		
1/2" x 1/4"	RS4/2-150	36		
1/2" x 3/8"	RS4/3-150	36		
3/4" x 1/2"	RS6/4-150	39		
1" x 1/2"	RS8/4-150	45		
1" x 3/4"	RS8/6-150	45		
1 1/4" x 1"	RS10/8-150	51		
1 1/2" x 1 1/4"	RS12/10-150	55		
2" x 1 1/2"	RS16/12-150	55		

150LB SCREWED PIPE FITTINGS 316 STAINLESS STEEL

Hex. Reducing Bush

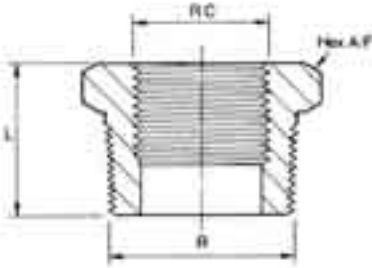

*Thread Sizes R - BSPT Male,
G - BSPP Female - See Thread * Size

Thread Size BSPT	Part Number	Dim L (mm)	Dim A/F (mm)	Dim (mm)
R x RC				
1/4" x 1/8"	HRB2/1-150	19	16	
3/8" x 1/4"	HRB3/2-150	19	19	
1/2" x 1/4"	HRB4/2-150	22	23	
1/2" x 3/8"	HRB4/3-150	22	23	
3/4" x 1/4"	HRB6/2-150	26	28	
3/4" x 3/8"	HRB6/3-150	26	28	
3/4" x 1/2"	HRB6/4-150	26	28	
1" x 1/4"	HRB8/2-150	28	36	
1" x 3/8"	HRB8/3-150	28	36	
1" x 1/2"	HRB8/4-150	28	26	
1" x 3/4"	HRB8/6-150	28	36	
1 1/4" x 3/4"	HRB10/6-150	33	46	
1 1/4" x 1"	HRB10/8-150	33	46	
1 1/2" x 3/4"	HRB12/6-150	35	50	
1 1/2" x 1"	HRB12/8-150	35	50	
1 1/2" x 1 1/4"	HRB12/10-150	35	50	
2" x 1"	HRB16/8-150	39	65	
2" x 1 1/4"	HRB16/10-150	39	65	
2" x 1 1/2"	HRB16/12-150	39	65	

Hex. Reducing Nipple

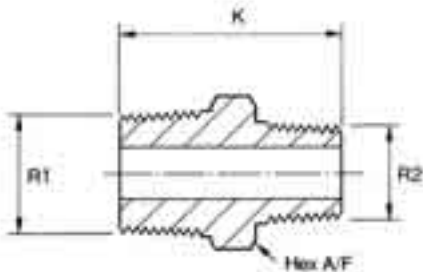

Thread Sizes R - BSPT Male
See Thread * Size

Thread Size BSPT	Part Number	Dim K (mm)	Dim A/F (mm)	Dim (mm)
R1 x R2				
1/4" x 1/8"	HRN2/1-150	31	17	
3/8" x 1/8"	HRN3/1-150	35	19	
3/8" x 1/4"	HRN3/2-150	35	19	
1/2" x 1/4"	HRN4/2-150	38	23	
1/2" x 3/8"	HRN4/3-150	38	23	
3/4" x 1/4"	HRN6/2-150	37	29	
3/4" x 3/8"	HRN6/3-150	41	29	
3/4" x 1/2"	HRN6/4-150	41	29	
1" x 1/2"	HRN8/4-150	46	37	
1" x 3/4"	HRN8/6-150	47	37	
1 1/4" x 3/4"	HRN10/6-150	51	46	
1 1/4" x 1"	HRN10/8-150	53	46	
1 1/2" x 3/4"	HRN12/6-150	50	54	
1 1/2" x 1"	HRN12/8-150	55	54	
1 1/2" x 1 1/4"	HRN12/10-150	56	54	
2" x 1"	HRN16/8-150	58	54	
2" x 1 1/4"	HRN16/10-150	63	65	
2" x 1 1/2"	HRN16/12-150	64	65	

Waverley weld fittings have been designed not only to produce a permanent welded system, but also to be used with the Waverley compression and screwed connections, allowing easy dis-assembly of joints.

The Waverley weld fitting range offers a fitting that couples high integrity with strength, the fittings are manufactured from 316 stainless steel. Component materials are traceable, even after many years in service due to the Waverley cast code system.

Features

Tapered tube socket design, enables you to lock the system together prior to welding (tack welding not required).

Fittings are manufactured to close tolerances for correct installation alignment.

Butt weld ends are produced with standard weld preparation for consistency of welded joints.

Waverley compression/weld fittings enable a component to be easily removed if required.

Sizes range from 1/4" - 1" welded, screwed, single and twin ring compression connections.

High quality bar and forged materials used throughout the range.

All materials conform to ASTM specifications.

Working pressures in accordance with piping code ANS1 B31.1 and refinery piping code ANS1 B31.3.

All threads NPT to ANS1 ASME B1.20.1.1983. Other connection threads available on request.

Tube socket union

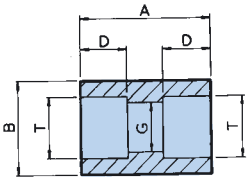

T tube OD	part number	A	B	D	G min	working pressure
1/4"	WTSU-2-SS	0.75"	0.50"	0.28"	0.18"	10241
3/8"	WTSU-3-SS	0.87"	0.62"	0.31"	0.28"	7760
1/2"	WTSU-4-SS	1.06"	0.75"	0.37"	0.40"	6391
3/4"	WTSU-6-SS	1.31"	1.06"	0.43"	0.62"	5521
1"	WTSU-8-SS	1.44"	1.37"	0.62"	0.87"	5055

Tube socket elbow

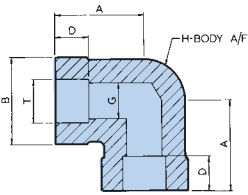

T tube OD	part number	A	B	D	G min	H A/F	working pressure
1/4"	WTSE-2-SS	0.84"	0.62"	0.28"	0.18"	0.50"	12728
3/8"	WTSE-3-SS	0.84"	0.62"	0.31"	0.28"	0.50"	7760
1/2"	WTSE-4-SS	0.97"	0.75"	0.37"	0.40"	0.62"	6391
3/4"	WTSE-6-SS	1.46"	1.25"	0.43"	0.62"	1.06"	7870
1"	WTSE-8-SS	1.59"	1.56"	0.62"	0.87"	1.37"	6969

Tube socket tee

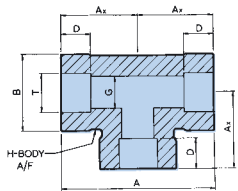

T tube OD	part number	A	B	D	G min	H A/H	working pressure
1/4"	WTST-2-SS	0.84"	0.62"	0.28"	0.18"	0.50"	12728
3/8"	WTST-3-SS	0.84"	0.62"	0.31"	0.28"	0.50"	7760
1/2"	WTST-4-SS	0.97"	0.75"	0.37"	0.40"	0.62"	6391
3/4"	WTST-6-SS	1.46"	1.25"	0.43"	0.62"	1.06"	7870
1"	WTST-8-SS	1.59"	1.56"	0.62"	0.87"	1.37"	6969

Tube socket male elbow

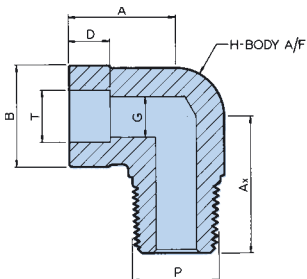

T tube OD	P pipe THRD	part number	A	AX	B	D	G min	H A/F	working pressure
1/4"	1/4"	WTSME-22-SS	0.84"	0.94"	0.62"	0.28"	0.18"	0.50"	12814
1/4"	3/8"	WTSME-23-SS	0.97"	1.13"	0.75"	0.28"	0.18"	0.62"	7587
3/8"	1/4"	WTSME-32-SS	0.84"	0.94"	0.62"	0.31"	0.28"	0.50"	7492
3/8"	3/8"	WTSME-33-SS	0.97"	1.13"	0.75"	0.31"	0.28"	0.62"	7587
1/2"	1/4"	WTSME-42-SS	0.97"	0.97"	0.75"	0.37"	0.28"	0.62"	6391
1/2"	3/8"	WTSME-43-SS	0.97"	1.13"	0.75"	0.37"	0.40"	0.62"	6352
1/2"	1/2"	WTSME-44-SS	1.09"	1.13"	0.93"	0.37"	0.40"	0.81"	9423
3/4"	1/2"	WTSME-64-SS	1.47"	1.13"	1.25"	0.43"	0.50"	1.06"	6415
3/4"	3/4"	WTSME-66-SS	1.47"	1.44"	1.25"	0.43"	0.62"	1.06"	7005
1"	3/4"	WTSME-86-SS	1.59"	1.66"	1.56"	0.62"	0.72"	1.37"	4651
1"	1"	WTSME-88-SS	1.59"	1.86"	1.56"	0.62"	0.87"	1.37"	5170

Tube socket female elbow

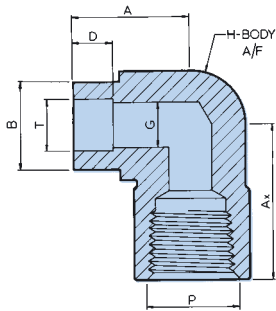

T tube OD	P pipe THRD	part number	A	AX	B	D	G min	H A/F	working pressure
1/4"	1/4"	WTSFE-22-SS	0.96"	1.19"	0.50"	0.28"	0.18"	0.62"	5941
1/4"	3/8"	WTSFE-23-SS	1.09"	1.37"	0.50"	0.28"	0.18"	0.81"	5857
3/8"	1/4"	WTSFE-32-SS	0.96"	1.19"	0.62"	0.31"	0.22"	0.62"	5941
3/8"	3/8"	WTSFE-33-SS	1.09"	1.37"	0.62"	0.31"	0.28"	0.81"	5857
1/2"	1/4"	WTSFE-42-SS	0.97"	1.19"	0.75"	0.37"	0.22"	0.62"	5941
1/2"	3/8"	WTSFE-43-SS	1.09"	1.37"	0.75"	0.37"	0.34"	0.81"	5857
1/2"	1/2"	WTSFE-44-SS	1.46"	1.63"	0.75"	0.37"	0.41"	1.06"	6391
3/4"	1/2"	WTSFE-64-SS	1.46"	1.63"	1.06"	0.43"	0.44"	1.06"	5521
3/4"	3/4"	WTSFE-66-SS	1.59"	1.94"	1.06"	0.43"	0.63"	1.37"	5521
1"	3/4"	WTSFE-86-SS	1.59"	1.94"	1.37"	0.62"	0.63"	1.37"	5055
1"	1"	WTSFE-88-SS	1.78"	2.25"	1.37"	0.62"	0.87"	1.68"	5055

Tube socket male connector

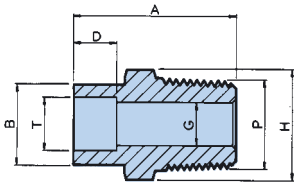

T tube OD	P pipe THRD	part number	A	B	D	G min	H A/F	working pressure
1/4"	1/4"	WTSMC-22-SS	1.19"	0.50"	0.28"	0.18"	0.56"	7492
1/4"	3/8"	WTSMC-23-SS	1.19"	0.50"	0.28"	0.18"	0.75"	4855
3/8"	3/8"	WTSMC-32-SS	1.25"	0.82"	0.31"	0.28"	0.68"	7492
3/8"	3/8"	WTSMC-33-SS	1.25"	0.82"	0.31"	0.28"	0.75"	6352
1/2"	1/4"	WTSMC-42-SS	1.37"	0.75"	0.37"	0.28"	0.87"	6391
1/2"	3/8"	WTSMC-43-SS	1.37"	0.75"	0.37"	0.40"	0.87"	6352
1/2"	1/2"	WTSMC-44-SS	1.59"	0.75"	0.37"	0.40"	0.87"	6391
3/4"	1/2"	WTSMC-64-SS	1.72"	1.06"	0.43"	0.50"	1.12"	5884
3/4"	3/4"	WTSMC-66-SS	1.72"	1.06"	0.43"	0.62"	1.12"	4651
1"	3/4"	WTSMC-86-SS	1.94"	1.37"	0.62"	0.71"	1.50"	4651
1"	1"	WTSMC-88-SS	2.12"	1.37"	0.62"	0.87"	1.50"	5170

Tube socket female connector

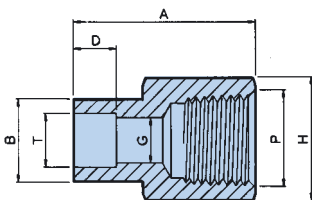

T tube OD	P pipe THRD	part number	A	B	D	G min	H A/F	working pressure
1/4"	1/4"	WTSFC-22-SS	1.09"	0.50"	0.28"	0.18"	0.75"	5941
1/4"	3/8"	WTSFC-23-SS	1.15"	0.50"	0.28"	0.18"	0.87"	4855
3/8"	1/4"	WTSFC-32-SS	1.15"	0.62"	0.31"	0.21"	0.75"	5941
3/8"	3/8"	WTSFC-33-SS	1.21"	0.62"	0.31"	0.28"	0.87"	4855
1/2"	1/4"	WTSFC-42-SS	1.25"	0.75"	0.37"	0.21"	0.87"	5941
1/2"	3/8"	WTSFC-43-SS	1.31"	0.75"	0.37"	0.34"	0.87"	4855
1/2"	1/2"	WTSFC-44-SS	1.50"	0.75"	0.37"	0.40"	1.12"	5315
3/4"	3/4"	WTSFC-66-SS	1.62"	1.06"	0.43"	0.43"	0.12"	4200
1"	3/4"	WTSFC-86-SS	1.71"	1.37"	0.62"	0.62"	1.50"	4200
1"	1"	WTSFC-88-SS	1.90"	1.37"	0.62"	0.78"	1.68"	4660

Pipe to tube adaptor

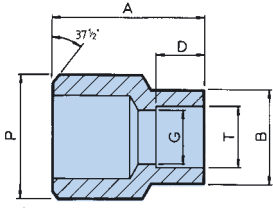

P pipe NB	T tube OD	part number	A	B	D	G	working min pressure
1/4"	1/4"	WPTA-22-SS	0.94"	0.50"	0.28"	0.18"	9731
3/8"	3/8"	WPTA-33-SS	1.00"	0.62"	0.31"	0.28"	7760
1/2"	1/2"	WPTA-44-SS	1.28"	0.75"	0.37"	0.40"	6391
3/4"	1/2"	WPTA-66-SS	1.41"	1.06"	0.43"	0.62"	5521
1"	1"	WPTA-88-SS	1.66"	1.37"	0.62"	0.87"	5055

Tube socket reducer

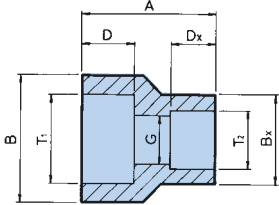

T1 tube OD	T2 tube OD	part number	A	B	Bx	D	Dx	G	working min pressure
3/8"	1/4"	WTSR-23-SS	1.82"	0.62"	0.50"	0.31"	0.28"	0.18"	7760
1/2"	1/4"	WTSR-42-SS	0.91"	0.75"	0.50"	0.31"	0.28"	0.18"	6391
1/2"	3/8"	WTSR-64-SS	0.97"	0.75"	0.62"	0.37"	0.31"	0.28"	6391
3/4"	1/2"	WTSR-84-SS	1.91"	1.06"	0.75"	0.44"	0.37"	0.40"	5521
1"	1/2"	WTSR-84-SS	1.25"	1.37"	0.75"	0.62"	0.37"	0.40"	5055
1"	3/4"	WTSR-86-SS	1.38"	1.37"	1.06"	0.62"	0.43"	0.62"	5055

Pipe socket union

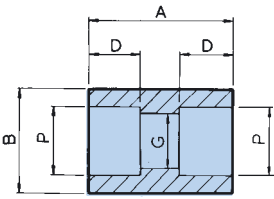

P pipe NB	part number	A	B	D	G	working pressure
1/4"	WPSU-2-SS	1.06"	0.98"	0.38"	0.41"	9250
3/8"	WPSU-3-SS	1.12"	1.11"	0.44"	0.50"	7820
1/2"	WPSU-4-SS	1.12"	1.36"	0.50"	0.73"	7662
3/4"	WPSU-6-SS	1.75"	1.48"	0.62"	1.06"	5404
1"	WPSU-8-SS	1.75"	1.86"	0.62"	1.06"	5571

Tube compression to tube socket connector

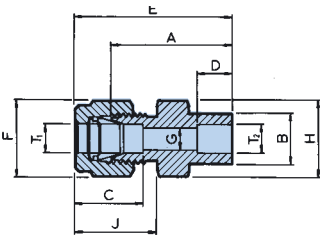

T1 tube OD	T2 tube OD	part number	A	B	C	D	E	F A/F	G min	H A/F	J
1/4"	1/4"	WRTSC-22-SS	1.00"	0.50"	0.61"	0.28"	1.30"	0.56"	0.18"	0.56"	0.70"
1/4"	3/8"	WRTSC-23-SS	1.09"	0.62"	0.61"	0.31"	1.39"	0.56"	0.18"	0.75"	0.70"
3/8"	3/8"	WRTSC-33-SS	1.16"	0.62"	0.67"	0.31"	1.45"	0.68"	0.28"	0.75"	0.76"
3/8"	1/2"	WRTSC-34-SS	1.28"	0.75"	0.67"	0.38"	1.58"	0.68"	0.28"	0.87"	0.76"
1/2"	1/2"	WRTSC-44-SS	1.28"	0.75"	0.91"	0.38"	1.69"	0.87"	0.40"	0.87"	0.87"
1/2"	3/4"	WRTSC-46-SS	1.44"	1.06"	0.91"	0.44"	1.84"	0.87"	0.40"	1.12"	0.87"
3/4"	3/4"	WRTSC-66-SS	1.44"	1.06"	0.97"	0.44"	1.84"	1.12"	0.62"	1.12"	0.87"
3/4"	1"	WRTSC-68-SS	1.65"	1.37"	0.97"	0.62"	2.06"	1.12"	0.62"	1.50"	0.87"
1"	1"	WRTSC-88-SS	1.75"	1.37"	1.27"	0.62"	2.26"	1.50"	0.87"	1.50"	1.08"

Tube compression to pipe butt connector

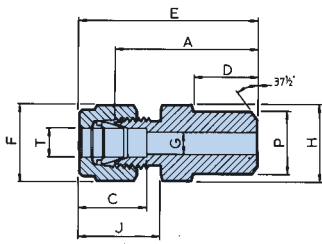

T1 tube OD	P pipe NB	part number	A	C	D	E	F A/F	G min	H A/F	J
1/4"	1/4"	WRPBC-22-SS	1.19"	0.61"	0.56"	1.52"	0.56"	0.18"	0.68"	0.70"
1/4"	3/8"	WRPBC-23-SS	1.22"	0.61"	0.56"	1.52"	0.56"	0.18"	0.75"	0.70"
3/8"	3/8"	WRPBC-33-SS	1.28"	0.67"	0.56"	1.58"	0.68"	0.28"	0.75"	0.76"
3/8"	1/2"	WRPBC-34-SS	1.50"	0.67"	0.75"	1.80"	0.68"	0.28"	0.87"	0.76"
1/2"	1/2"	WRPBC-44-SS	1.50"	0.91"	0.75"	1.19"	0.87"	0.40"	0.87"	0.87"
1/2"	3/4"	WRPBC-46-SS	1.53"	0.91"	0.75"	1.94"	0.87"	0.40"	1.12"	0.87"
3/4"	3/4"	WRPBC-66-SS	1.53"	0.97"	0.75"	1.94"	1.12"	0.62"	1.12"	0.87"
3/4"	1"	WRPBC-68-SS	1.87"	0.97"	0.94"	2.28"	1.12"	0.62"	1.50"	0.87"
1"	1"	WRPBC-88-SS	1.97"	1.27"	0.94"	2.48"	1.50"	0.87"	1.50"	1.08"

Tube compression to tube socket elbow

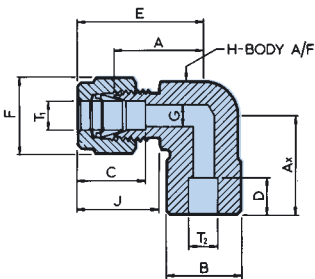

T1 tube OD	T2 tube OD	part number	A	Ax	B	C	D	E	F A/F	G min	H A/F	J
1/4"	1/4"	WRTSE-22-SS	0.77"	0.84"	0.62"	0.61"	0.28"	1.07"	0.56"	0.18"	0.50"	0.70"
1/4"	3/8"	WRTSE-23-SS	0.77"	0.87"	0.62"	0.61"	0.31"	1.07"	0.56"	0.18"	0.50"	0.70"
3/8"	3/8"	WRTSE-33-SS	0.91"	0.96"	0.75"	0.67"	0.31"	1.12"	0.68"	0.28"	0.62"	0.76"
3/8"	1/2"	WRTSE-34-SS	0.91"	1.00"	0.75"	0.67"	0.37"	1.12"	0.68"	0.28"	0.62"	0.76"
1/2"	1/2"	WRTSE-44-SS	1.02"	1.09"	0.93"	0.91"	0.37"	1.43"	0.87"	0.40"	0.81"	0.87"
1/2"	3/4"	WRTSE-46-SS	1.02"	1.46"	1.25"	0.91"	0.43"	1.43"	0.87"	0.40"	1.06"	0.87"
3/4"	3/4"	WRTSE-66-SS	1.17"	1.46"	1.25"	0.97"	0.43"	1.58"	1.12"	0.62"	1.06"	0.87"
3/4"	1"	WRTSE-68-SS	1.36"	1.59"	1.56"	0.97"	0.62"	1.77"	1.12"	0.62"	1.37"	1.08"
1"	1"	WRTSE-88-SS	1.45"	1.59"	1.56"	1.27"	0.62"	1.97"	1.50"	0.87"	1.37"	1.08"

Tube compression to pipe butt elbow

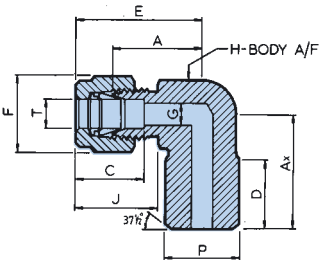

T1 tube OD	P pipe NB	part number	A	Ax	C	D	E	F A/F	G min	H A/F	J
1/4"	1/4"	WRPBE-22-SS	0.77"	1.00"	0.61"	0.56"	1.07"	0.56"	0.18"	0.50"	0.70"
1/4"	3/8"	WRPBE-23-SS	0.77"	1.06"	0.61"	0.56"	1.07"	0.56"	0.18"	0.62"	0.70"
3/8"	3/8"	WRPBE-34-SS	0.91"	1.06"	0.67"	0.56"	1.12"	0.68"	0.28"	0.62"	0.76"
3/8"	1/2"	WRPBE-44-SS	0.91"	1.34"	0.67"	0.75"	1.12"	0.68"	0.28"	0.81"	0.76"
1/2"	1/2"	WRPBE-44-SS	1.02"	1.34"	0.91"	0.75"	1.43"	0.87"	0.40"	0.81"	0.87"
1/2"	3/4"	WRPBE-46-SS	1.02"	1.50"	0.91"	0.75"	1.43"	0.87"	0.40"	1.06"	0.87"
3/4"	3/4"	WRPBE-66-SS	1.17"	1.50"	0.97"	0.75"	1.58"	1.12"	0.62"	1.06"	0.87"
3/4"	1"	WRPBE-68-SS	1.36"	1.90"	0.97"	0.93"	1.77"	1.12"	0.62"	1.37"	0.87"
1"	1"	WRPBE-88-SS	1.45"	1.90"	1.27"	0.93"	1.97"	1.50"	0.87"	1.37"	1.08"

OTHER WAVERLEY BROWNALL PRODUCTS

Our wide product range offers you everything from complete instrumentation packages to a one off requirement. Experience with supplying customer specials means that we can effectively source complementary products or meet your requirements from our specials design and manufacturing operation.

In addition to our standard range of 316 stainless steel products; we offer compression fittings in monel and other exotic metals.

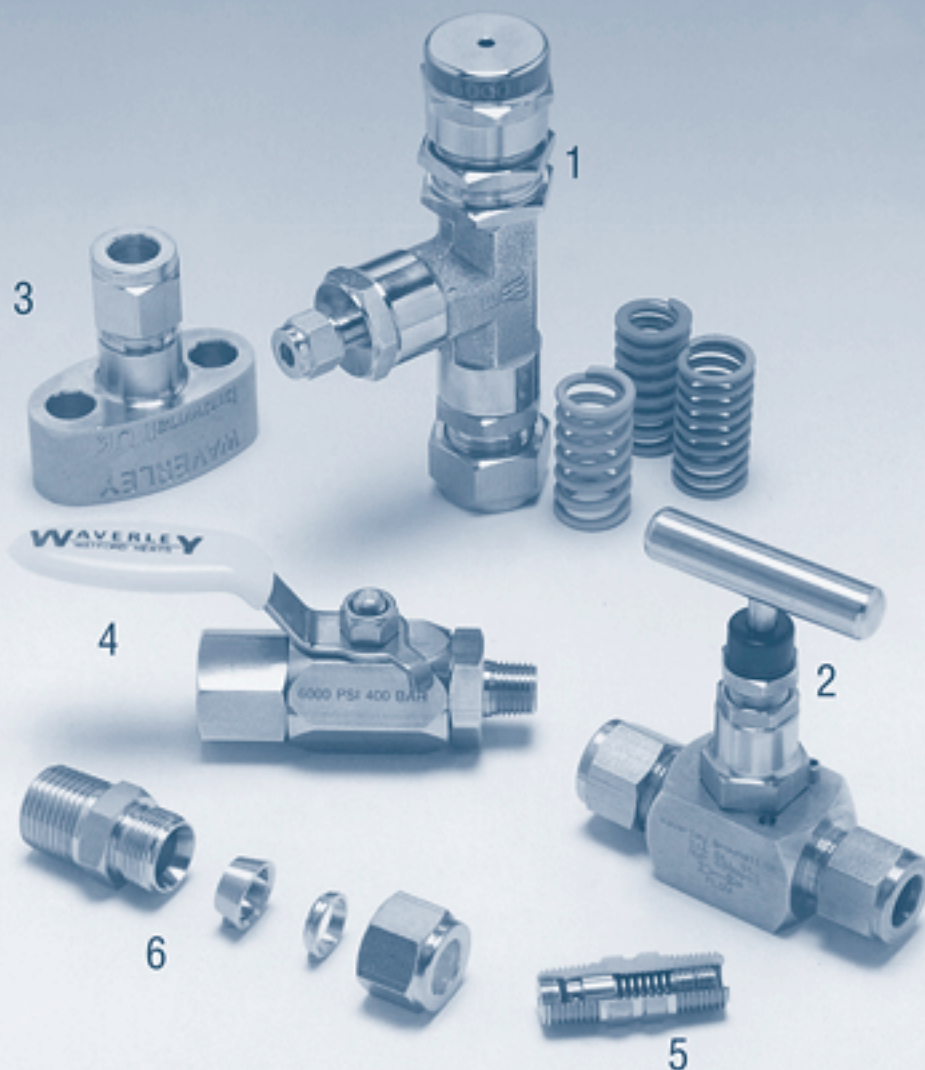

1. Relief valves with a full range of end connections
2. Needle valves up to 10,000 psi
3. Duoloc and Ringlok Flange fittings
4. Ball valves up to 6,000 psi
5. Mini check valves
6. Ringlok twin ferrule compression fittings

Waverley brownall

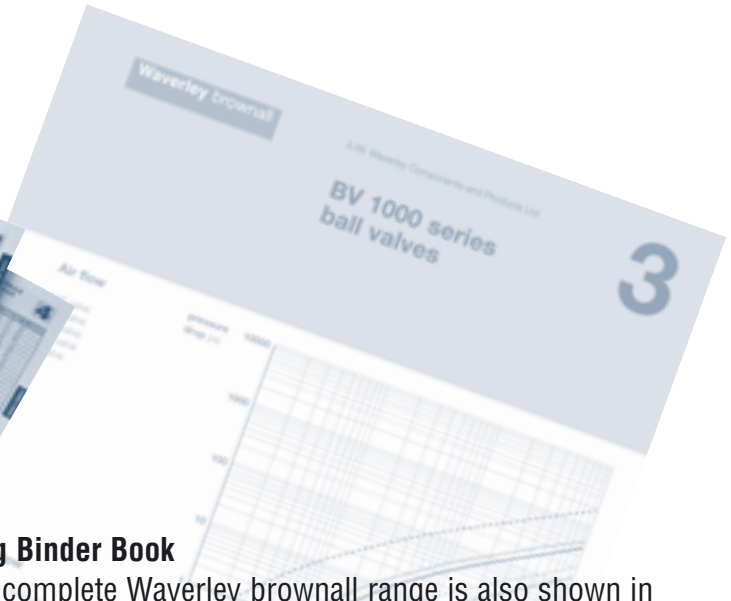

Ring Binder Book

The complete Waverley brownall range is also shown in detail in a ring binder for ease of reference.



Electronic Catalogue

The Waverley brownall electronic catalogue offers you a fast and accurate means of selecting the right 316 stainless steel fittings and valves for your instrumentation applications.

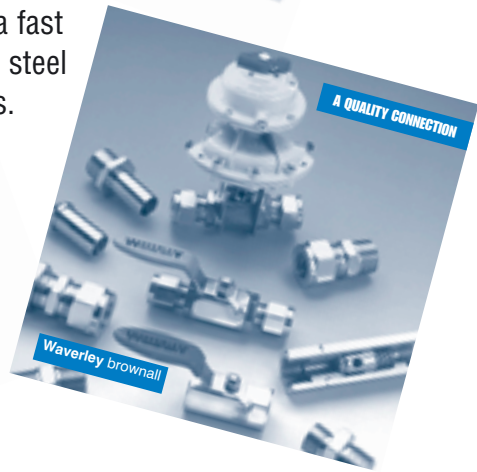

Compact Product Catalogue

Gives a complete overview of our entire range.



Waverley brownall Ltd
46, The Vintners, Temple Farm Industrial Estate
Southend-on-Sea, Essex SS2 5RZ
Tel: +44 (0)1702 600014
Fax: +44 (0)1702 613600
email: sales@waverleybrownall.co.uk
www.waverleybrownall.co.uk
Waverley brownall Scotland
Tel: +44 (0)1224 877323