

High pressure technology that sets the standard



High pressure plunger pumps

High pressure pump units

Application engineering



Calder offer a wide range of high pressure pump packages incorporating Hammelmann pumps for the chemical, oil and gas industries. Visit our website.

HAMMELMANN

www.calderltd.com

Hammelmann pumps with either 3 or 5 plungers are based upon proven, well engineered components and stand out due to their small footprint, low maintenance costs and high operational efficiency.

Pump head

The pump head contains the suction/ discharge valve sets. The pressurised medium produced by each individual plunger flows to a common high pressure discharge connection. The pump head valve housing is not subjected to alternating stress.

Suction chamber

The medium is fed to the pump via a central inlet in the suction chamber. The sealing system components subjected to alternating pressures are located within the suction chamber and are completely immersed in the medium. This enclosed system offers additional safety.

Bellows system

The bellows sealing system hermetically separates the medium end from the power end (crank section) preventing the ingress of fluid or gas. The standard bellows material is Viton but HNBR and PTFE versions are available for special applications.

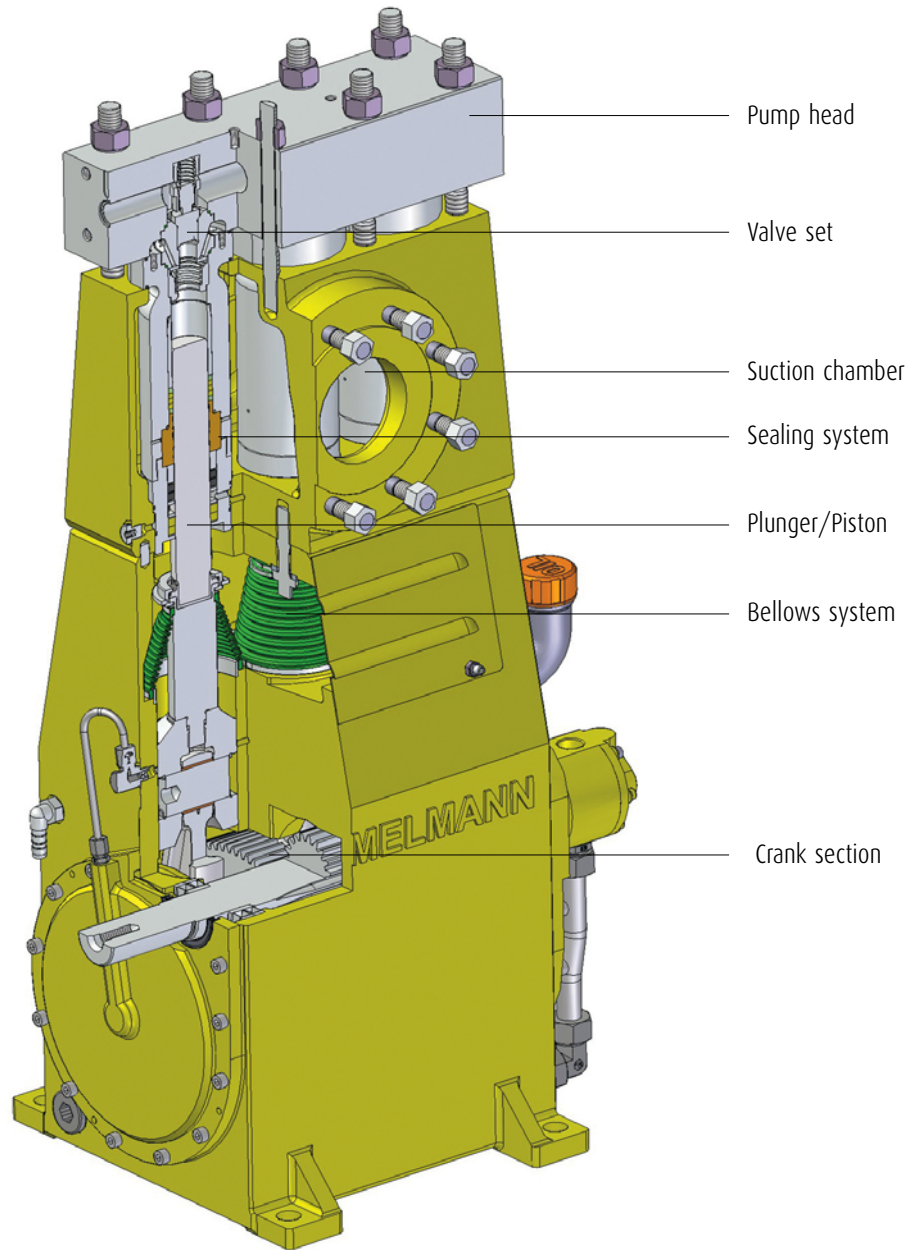

Crank section

The integral speed reducer using twin helical gears arranged in herringbone configuration ensures smooth running and even power transmission without axial load to the bearings.

A selection of gear ratios is available to allow the optimal choice of driver. Mechanical efficiency is in excess of 95%.



The compact construction eliminates the need for an external gear box or an oversized flywheel mass.

High pressure seals

The various plunger seal systems employed by Hammelmann enable safe and reliable, continuous duty at operating pressures up to 3800 bar. The choice of seal system used is dependant upon the pump application.

Packed sealing

The high pressure seal is made by packing rings. Plunger guidance is by means of a separate bush. This packed seal is particularly good when the pumped medium is abrasive or corrosive.

Labyrinth sealing

With this design the seal is made by a tiny amount of medium being forced downwards into the very fine cylindrical gap between the plunger and the labyrinth insert. The flow velocity and therefore the pressure decreases as the medium travels further downwards. This tiny amount of medium also acts as a component lubricant before returning to the suction chamber.

Dynamic plunger sealing

The dynamic plunger sealing system is used mainly for ultra high operating pressures. This design also produces very high volumetric efficiency.

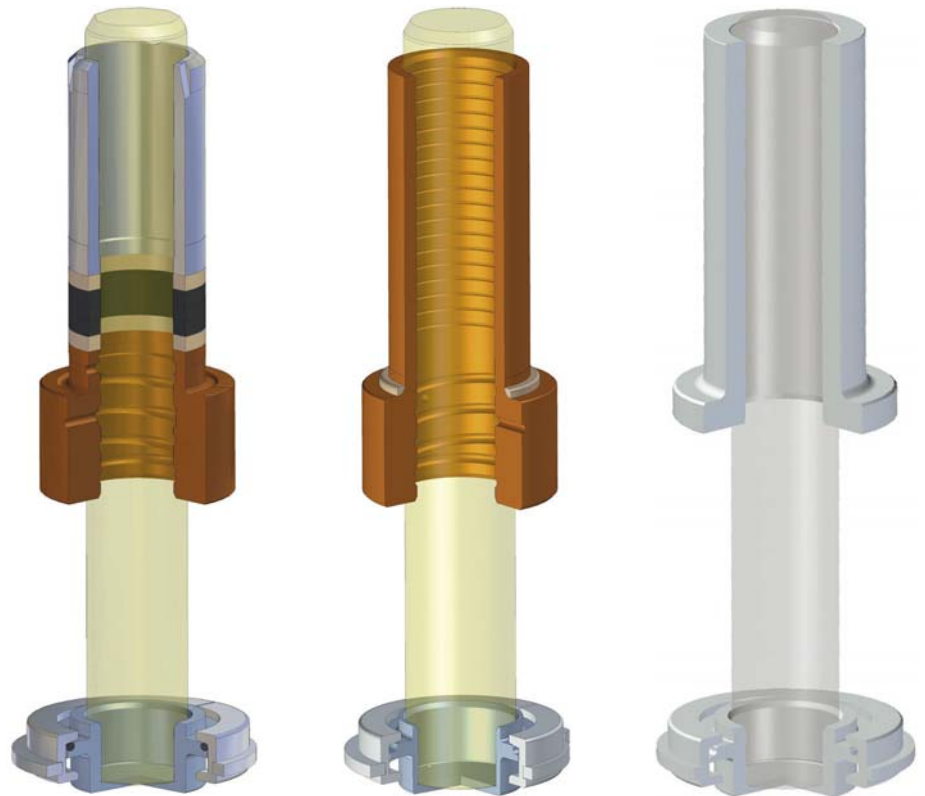

Packed sealing
up to 1600 bar

Labyrinth sealing
up to 2000 bar

Dynamic sealing
up to 3800 bar

Valves

Differing valve designs are available to suit the pumped medium.

Conical/Disc valves

Standard design

In this arrangement there is a conical valve on the discharge side and a disc valve on the suction side. Both sealing seats are in a single valve seat ring saving space and minimising 'dead' room.

Twin conical valves

Special design for certain applications

The discharge and suction valves are both conical.

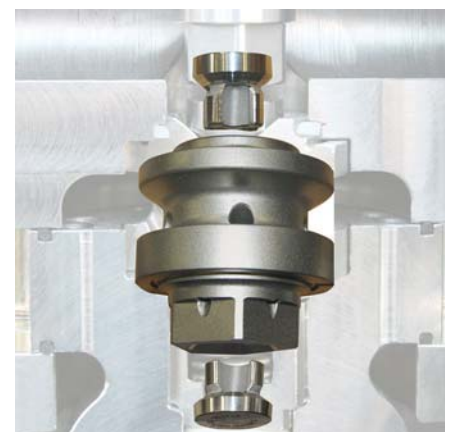

Compact construction

Hammelmann pumps are renowned for producing high performance within a very small footprint. This is achieved by the compact design featuring the integral gearbox and the space saving vertical configuration.



All oscillating forces are vertical and are absorbed by the base frame. Unwanted lateral oscillations as produced by horizontally configured pumps cannot occur.

Materials

All raw materials and purchased components are subjected to the stringent controls of our Quality Management System. Materials are individually selected based on component function, load and area of application.

Directives and standards

Hammelmann high pressure pumps are manufactured in accordance with European directives and standards. We can of course manufacture in compliance with customer's specifications.

Development technology

Using modern development technologies such as FEM (Finite Element Method) and CFD (Computational Fluid Dynamics) as early as the planning stage ensures the optimal design of components.

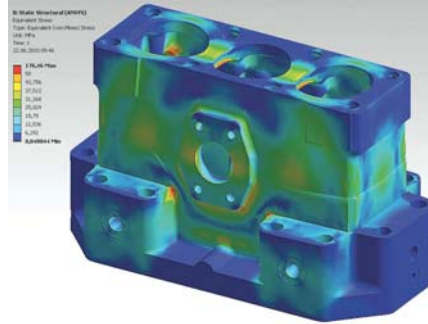

During new development work comprehensive stress and long term fatigue testing is carried out. The resultant data is extensively analysed and incorporated in the component design as required.

Customer specific special designs are developed in close cooperation with the client as a project with input from both parties.

Quality control

Hammelmann believe in a start to finish, unbroken flow of data from the final design stage, over the programming process including choice of tooling and selection of the machines.



Hammelmann products are subjected to strict quality control procedures. All pumps are extensively tested in our modern test centre prior to delivery.

Maintenance

A basic design principle of Hammelmann is to ensure that the customer can service the pump quickly and easily. Maintenance therefore is carried out from above. By simply removing the valve housing you have fast, uncomplicated access to all important pump head wearing parts.

The individual plunger seal sets can be quickly disconnected and be lifted out of the suction chamber for replacement or repair.

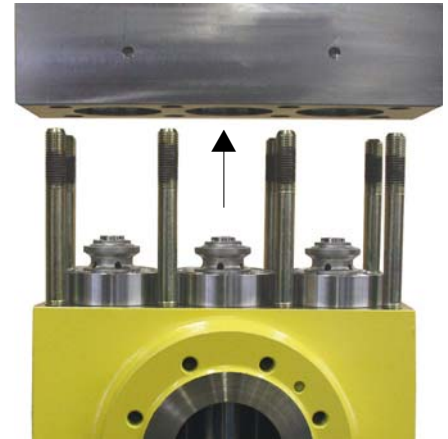

Plunger speed

Moderate plunger speeds limit wear of plungers and sealing elements.

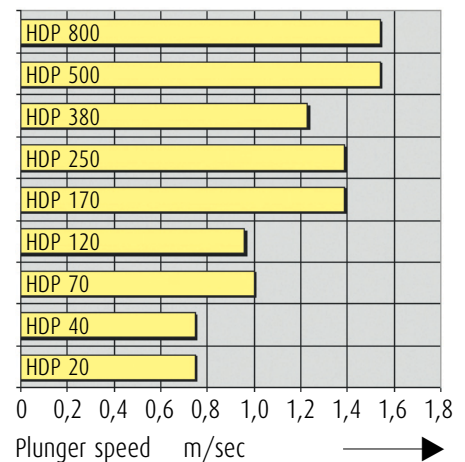

Conversion kits

All Hammelmann pumps can be converted to other operational parameters (flow rate and operating pressure) with the acquisition of a conversion kit. Due to the design of the Hammelmann pump this can be carried out quickly with standard tools.

If there is a regular need to change the performance of ultra high pressure pumps or pump models HDP 380 and above conversion is even faster. The pump head and the plunger seal sets form a single assembly which increases the reliability of the conversion and reduces the time required to a matter of minutes.



Step 1: Disconnect the plungers



Step 2: Remove the pump head nuts



Step 3: Lift out the complete medium bearing end and store. Fit the new medium bearing end in the reverse order.

Controls

ES 2 controller



Hammelmann's exclusive ES 2 controller based on SDM technology controls the complete high pressure pump unit.

The ES 2 is a microprocessor that controls diesel engine driven units and electrically powered units that are outfitted with a frequency converter. It constantly carries out complex monitoring and regulating functions whilst collecting data for the various diagnostic functions.

Actual status data from the diesel engine is transmitted via CAN-Bus to the ES 2. All possible engine malfunctions appear as a fault code in the display with the most critical enhanced by clear text announcements.



Hammelmann control systems will continue to reflect the demands of the market place.

NANO-B controller (SPC)



Controls and monitors constant speed, electrically powered pump units (star delta or soft start).



- Pump monitoring with analogue sensors
- Information menu with actual unit status (bar/°C)
- Fault announcements in clear text
- NANO SPC enables special control functions and projects.

High pressure pumps

Hammelmann high pressure pumps are built for continuous duty within their stated performance parameters. Refer to the individual pump data sheets for the crankshaft speeds, average plunger speeds, plunger diameters and power ratings.



HDP 20: up to 18,5 kW
up to 3500 bar, up to 103 l/min



HDP 40: up to 37 kW
up to 3800 bar, up to 155 l/min



HDP 70: up to 70 kW
up to 3800 bar, up to 246 l/min



HDP 120: up to 120 kW
up to 3800 bar, up to 326 l/min



HDP 170: up to 170 kW
up to 3800 bar, up to 460 l/min



HDP 250: up to 250 kW
up to 3800 bar, up to 766 l/min



HDP 380: up to 380 kW
up to 3000 bar, up to 841 l/min



HDP 500: up to 500 kW
up to 3000 bar, up to 1058 l/min



HDP 800: up to 800 kW
up to 3000 bar, up to 2100 l/min



Mining industry pump
HDP 250 L: up to 250 kW
up to 3000 bar, up to 766 l/min



Sewer cleaning pump
HDP 146: up to 135 kW
up to 230 bar, up to 462 l/min



Sewer cleaning pump
HDP 196: up to 180 kW
up to 210 bar, up to 605 l/min

High pressure pump units

The pumps are configured as complete units to meet the requirements of the many varied industrial applications.



Stationary unit with electric motor and controller



Extra compact electric unit for on board ship applications



Stationary unit with frequency converter for a jet cutting table or for pressurised coolant/lube feed



In plant trailer mounted electrically powered unit with control cabinet



Transportable unit with extra strength base and frame for deep mining applications



Stationary unit with electric motor



Stationary unit with diesel engine



Diesel unit with V-belt drive



Road going diesel unit



Built into 10' and 20' containers or special sizes

Built into a truck



Built into a BDF swap body container

Standard

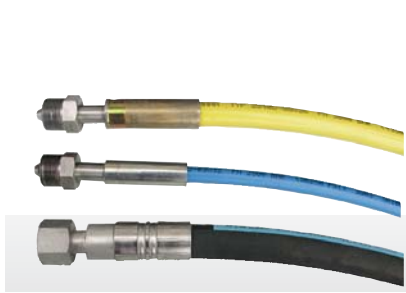

High pressure hoses are cut and assembled with end fittings in house and in accordance with certified procedures



High pressure water blasting guns with various activation and control mechanisms

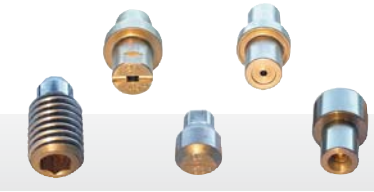

Round and flat jet nozzle inserts in a variety of sizes, shapes and materials



Bypass key switch



Bypass foot switch and mechanical, electro/mechanical foot valves in various designs



Protective clothing and safety accessories

Surface cleaning/preparation



Rotorjets for use with high pressure blasting guns and lances



Pneumatically powered Rotorjet with a selection of nozzle holders



Mechanically deployed Rotorjets for special cleaning systems



Hydraulically or electrically powered Rotorjets



Spray bars for various applications



Multiple Rotorjets, electrically powered

Surface cleaning/preparation

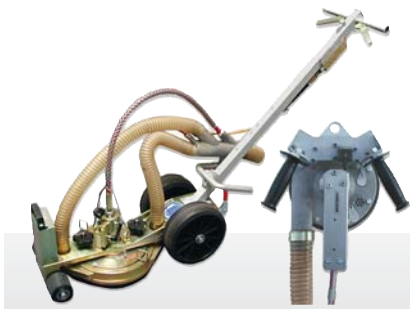

Aquablast® surface blasters with and without direct vacuuming

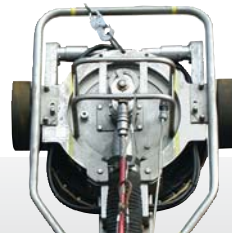

Spiderjet® attaches to the work surface by the same vacuum power that collects the waste and waste water



Dockmaster® semiautomatic blasting vehicle for surface preparation on ship hulls



Dockboy® semi-automatic tracked vehicle for surface preparation on hull bottoms and other metal surfaces



The water jet velocity entrains abrasive to form a water/abrasive jet to strip and roughen metals



Hand rail cleaner removes rust and old coatings down to bare metal prior to recoating

Tank cleaning



Aquamat® 3 D tank cleaning heads remove soft and hard deposits from the internal surfaces of tank walls



Nozzle arms for tank cleaning heads with a range of formats, leverage angles and lengths



Protective cages and fittings for tank cleaning heads



Hose reels



Aquarex® systems for deploying tank cleaning heads to internally clean a variety of tank and vessel designs

Heat exchanger cleaning

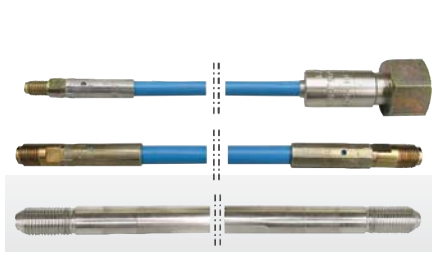

Rigid and flexible lances

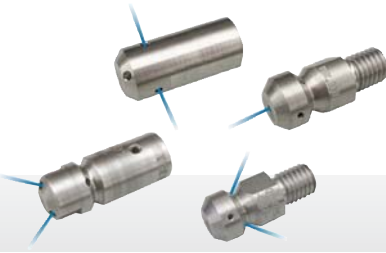

Nozzles with multiple bores for heat exchanger bundle tube internal cleaning

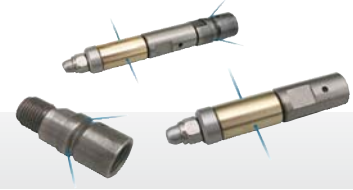

Turbojets with fast spinning bore sections

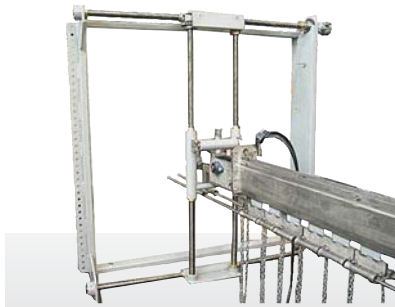

Pipemaster system with rotating lances for semiautomatic heat exchanger cleaning



Positioning and safety device for working with manually deployed lances

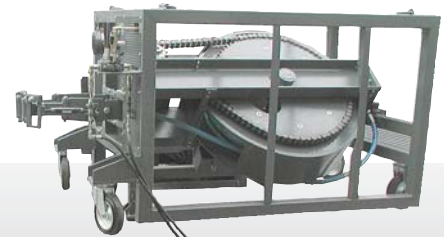

Rotating hose reel for cleaning vertical and horizontal heat exchangers

Pipe and sewer cleaning



Reversible nozzles can be switched from 'push' to 'pull' either manually or remotely



Rotorjets to remove hard deposits



Cleaning nozzles for large sewers



Nozzle holder designs for rotating hose reels

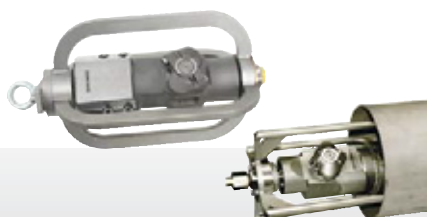

3 D pipe cleaners

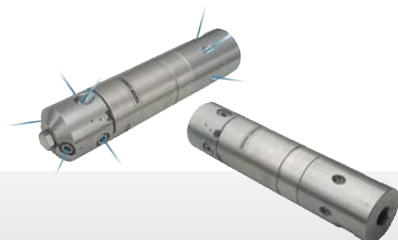

Oil industry down hole cleaners with radial and 'push' nozzles at the front and 'pull' nozzles at the rear

Water hydraulics



Pneumatically actuated pressure regulating valve for smooth adjustment of pump operating pressure

Changeover valves divide the total flow of the pump equally or unequally between a number of blasting tools

Pressure maintaining valves, non return valves and safety valves

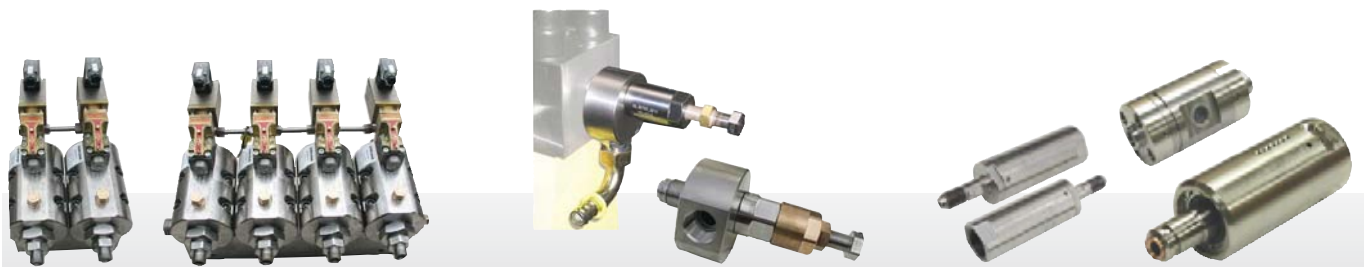

Solenoid valves open and close various blasting tools

Flow diverter (splitter) nozzles reduce excess operating pressure flow to ambient pressure

Rotary joints can be outfitted with various blasting tools

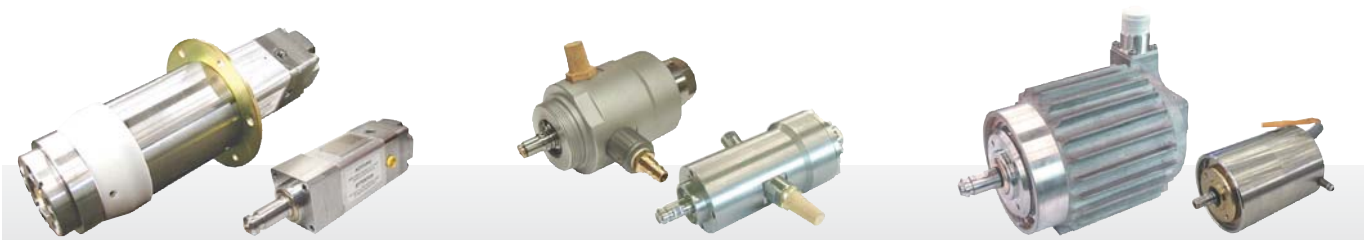

Oil hydraulically driven rotary joints

Pneumatically driven rotary joints

Electrically driven rotary joints

Abrasive cutting

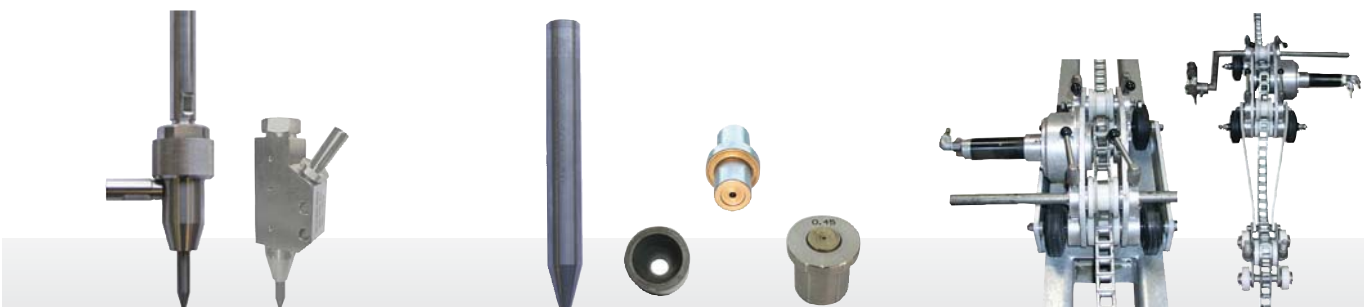

A water jet entrains the abrasive inside the cutting head housing

Focusing nozzle, guide piece and water nozzle inserts for cutting heads

Nozzle carrier with guide rail for flat surfaces and tensioning device for cutting pipes

Service

Service centre

A product is only as good as the service the manufacturer provides. Hammelmann is known internationally for reliable and fast customer service.



Flexible, competent and experienced staff are always ready to carry out servicing and repair works.

Logistic centre

With our logistic centre we can offer our customers a very fast spare parts service. Around 15000 different active parts can be accessed within a short time span.



Calder Ltd.

Prescott Drive
Warndon
Worcester
WR4 9NE
United Kingdom

Phone: 0044 (0) 1905 759090
Fax: 0044 (0) 1905 759091
sales@calder.co.uk
www.calderltd.com

Training

Professional instruction of operational personnel is extremely important. Learning by doing in realistic situations will enable personnel to retain the knowledge they gain.



Based on the participant's needs and their existing knowledge we provide practical and theoretical training covering the following subjects:

- Safety
- Proper operating procedures
- Maintenance and repair
- Basics of application technology
- High pressure pumps
- Accessories and systems

As a business operating in a global market and with subsidiary companies in the USA, Brazil, China, Australia and Spain plus around 40 international partners Hammelmann provide a worldwide service.



Oelde headquarters and plant

HAMMELMANN

Hammelmann
Maschinenfabrik GmbH



Member of INTERPUMP GROUP

Zum Sundern 13-21 · 59302 Oelde · Germany
Telephone +49 25 22 76-0, Telefax +49 25 22 76-444
eMail: mail@hammelmann.de · www.hammelmann.com

Technology centre

By simulating the production process and carrying out individual tests the necessary performance parameters are defined, recorded and evaluated to arrive at a practical proposal.



For your own testing we provide you with an applications engineer and a technician plus various water tools and a range of inspection instruments, rotary joints and special nozzles.

Hammelmann products are manufactured using the most modern machines available today. Strength in depth manufacturing capability enables maximum flexibility in producing high quality products.