

### CIRCUIT PROTECTION EQUIPMENT



### MOTOR CONTROL GEAR COMPONENTS



### POWER PROTECTION DEVICES





# Chint capabilities extend from the Power Station to the Home



Inverter ■ ACB ■ Solar Panel ■ Resin Core Transformer ■ Oil Filled Transformer

**For further information on each of these products  
contact Chint on 0161 762 9333**

## CIRCUIT PROTECTION EQUIPMENT

NXDB MK III 3 Phase 125A TP&N Boards	6
NXDB MK III Overview	7
NXDB MK III Product Features	8-9
NXDB MK III Metering	10
PAN Assemblies	11
NXDB MK III Power & Lighting Boards	12
NXDB MK III Wiring Diagrams	13
NXDB MK III Options	14
Wall Mounted Metal Enclosures	15-16
Single Phase Metal Consumer Units	17
Consumer Units	18-21
Enclosures & Pre-assembled Enclosures	19
26 & 36 Way Insulated Consumer Units	20
1P & 2P 6KA MCBs	22
3P & 4P 6KA MCBs	23
1P & 2P 10KA MCBs	24
3P & 4P 10KA MCBs	25
eBG Breakers	26
1P + N MCBs	26
High Current MCBs	27
Residual Current Devices	28
Time Delay RCDs	28
RCBOs	29
RCBO 1P + N	30
Isolators	31
Enclosed Rotary Isolators	31
MCB Accessories	32
Din Rail	32
2 Gang RCD Sockets	33
Modular AC Contactors	33
Bell Transformer	33
Surge Arrestor	34
Digital Programmable Timer	34
Electronic Timers	35
Staircase Timer	35
Impulse Relay	36
Earth Leakage Relay	37
Transformers	37-38
Limit Switches	38
Consumer Unit & Enclosure Dimensions	67-68

Minimum order value is £50.00.

Orders above £300 carriage paid.

Orders under £300 carriage is £12.50.

Saturday and Special timed deliveries are available at extra cost.

Please note: All measurements are shown in millimetres.

## MOTOR CONTROL GEAR COMPONENTS

AC Coil Contactors 3 & 4 Main Pole	40-41
DC Coil Contactors	42
Power Factor Correction Contactors	42
Thermal Overload Relays	43-44
Overload Relays	44
Overload Mounting Brackets	44
Pneumatic Timers	44
Mechanical Interlocks	44
AC Spare Coils	45
Head Mount Auxiliary Contact Blocks	45-46
Terminal Cover	46
Side Auxiliary Contact	46
DC Spare Coils	46
Direct On Line Starters	46
Manual Motor Starters	47
Manual Motor Starter Accessories	47
22.5mm Control Components	48-50
Control Components	51-52
Modular Indicators	52

## POWER PROTECTION DEVICES

Moulded Case Circuit Breakers Overview	54
NM8-125S Frame, Thermal Magnetic	55
NM8-250S Frame, Thermal Magnetic	55
NM8-400S Frames, Thermal Magnetic	56
NM8-800S Frame, Thermal Magnetic	56
NM8-1250S Frame, Thermal Magnetic	57
NM8S-400S Frame, Electronic	57
NM8S-630S Frame, Electronic	58
NM8S-800S Frame, Electronic	58
NM8S-1250S Frame, Electronic	58
125A Frame Accessories	59
250A Frame Accessories	59
400A & 600A Frame Accessories	60
800A & 1250A Frame Accessories	60
MCCB Specifications & Dimensions	61-62
ELCB MCCB	63
Automatic Transfer Switch	64
MCCB Type Isolator	65
Switch Disconnecter	65
Air Circuit Breaker	66

**AT CHINT WE ENDEAVOUR TO:**

To supply product equal to the best  
Be competitive in price, offering true value for money  
React in a timely manner  
Be easy to trade with

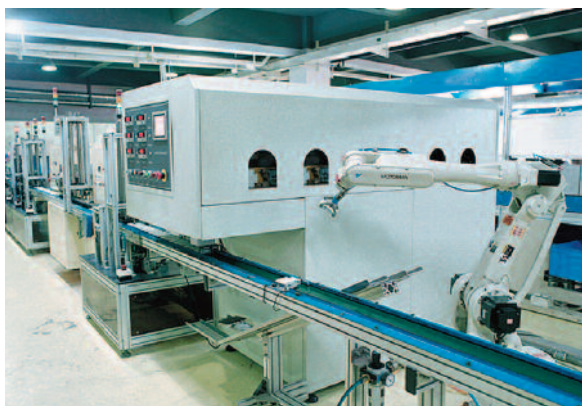

Product Approval Certificates and Technical Catalogues are available on request.



# CIRCUIT PROTECTION EQUIPMENT

# CHINT SHIELD

## Shield Range

## NXDB 125A TP&N Distribution Boards and Metering Solutions



- Individual boards are supplied with 125A Busbars and 4P, 125A Isolators
- Where 2 boards are combined using Splitter Kit MRJ4M-LS02, a 4P 250A Isolator is included
- Extension/Spreader Boxes part no. EX1803/SB are prefitted with a full width piece of 35mm Top Hat section Din Rail for housing a wide selection of Control Panel Components
- Various locking options are available
- Can be mounted together either Vertically OR Horizontally as Combined Power and Lighting Boards helping address Section L2 of the current Building Regulations



Metering Capability



## NXDB MK III Product Overview

### Robust ALL METAL TP&N Boards: 4, 6, 8, 12 and 18 Ways, *alternatively with Glazed Door.*

Boards can be mounted together, **vertically** or **horizontally** with or without **Meter kits**. Extension Boxes are available for use as Cable Spreader units, fitted with 35mm DIN rail to mount various components, alternatively with a 250A, 4 Pole Isolator to be used where 2 boards are combined.

Units are Powder Coated to RAL 7035 over pretreated Heavy Gauge Steel with welded corners.

A wide selection of laser pre cut cable entries which are easily removed without deforming the outer case.

A selection of PAN assemblies are available for mounting directly to Control Panels. 8, 12, and 18 ways.

The boards are available as individual units as shown on the following pages, alternatively Chint will assemble them to customer specification, fitting MCBs, RCBOs as detailed.



**PLEASE NOTE:**

Where Chint assemble boards to customer requirements be aware that weight may be an issue. Chint will take responsibility for shipping to a UK site address with the equipment mounted where appropriate to pallets and off loaded at the Kerbside. It is the client's responsibility to remove the equipment from the kerbside to a final installation point. We use 3rd party contractors for shipping, **it is crucial that firm arrangements are made to receive the goods.**

\*Various weights are shown. Carriage is charged extra on NXDB Boards.

Adequate Main and Earth connections are provided, it is the installer's responsibility to ensure these are adequately tightened when the system is being commissioned.

## Product Features

### Chint 125A “SERIES 3” B Boards

Chint “Series 3” B Boards are manufactured from Sheet Steel to meet the requirements of **BS-EN 60439** with an **IP rating of IP3X**.

The main boards designed and manufactured in the UK are of pleasing appearance, finished in smooth powder coated pale grey paint to RAL 7035 over pre treated steel.

Available sizes are 4, 6, 8, 12 and 18 Ways, a 4 Pole 125A Incomer is included as standard.

- 4, 6, 8, 12 and 18 Way, boards made in the UK
- Accepts Chint 6KA and 10KA MCBs, 10KA RCBOs
- 4 Pole, 125A Incomer fitted as standard
- Locking Capability – Separately Padlockable Main Boards and Extension Boxes
- Can be mounted in either portrait or landscape format as Power & Lighting Boards



250A Mains Incomer Unit



Isolator can be locked off with up to 3 padlocks



Accessory: NXDB-Link



Chint NXDB MK III Distribution Boards are pre fitted with ½ turn coin operated fasteners to both the main boards and the cable spreader boxes.



## Product Features

### Chint NXDB MK III Showing Glazed Doors



Glazed Door Main Panel and plain front Cable Spreader Box.

Glazed Door Main Panel with a bottom fitted Extension Box for use either as an Extension Box or Metering Unit.

### Easy Viewing, Neutral Colour

**Chint NXDB Mk III TP&N Distribution Boards** are readily available with all metal, or glazed doors, finished in a pleasing neutral colour so as not to look out of place in most Commercial, Industrial applications.

The Cable Spreader Boxes are supplied with a full length of 35mm DIN Rail to allow components such as contactors, MCBs and various other components to be easily mounted either side of the incoming cables, in effect build a mini Control Panel.

The Acrylic Glazing is held in place with high specification adhesive.



Wide range of Circular Conduit holes and square cut out for trunking, these are all laser pre cut so as to give easy access without damaging the Gland Plates.



## Metering

### With Double CT Connection, DIN Rail Mounting and LCD Display

- Split Load, Dual CT Input Meter
- 4 Module DIN Rail mounting
- Single phase or 3 phase (4 wire) network balanced or unbalanced load
- Built-in dual energy pulse output, one for each load and RS485 MODBUS communication
- Wide range of measured parameters (see table below)
- High quality backlit LCD display
- 330mV current Transformer input
- Active energy class 1 (EN62053-21)
- Reactive energy class 2 (EN62053-23)
- THD up to 31st harmonic for voltage and current
- 3 phase: 140...460Vac measured voltage
- Single phase: 80...265Vac measured voltage
- Self supplied auxiliary
- Programmable CT ratio 5...10,000A per load
- Programmable VT ratio
- Frequency 45/65Hz
- Selectable CT phase correction allows reversal of L1 and L3
- Weight 200g

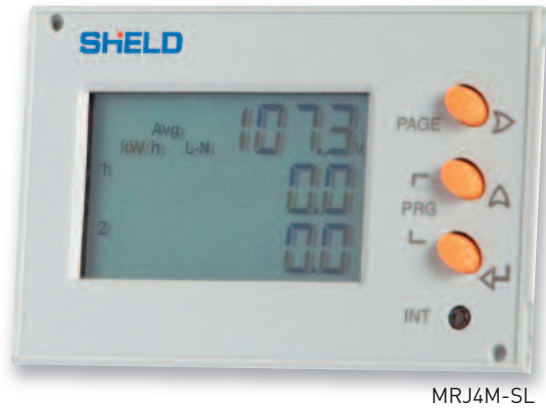

MRJ4M-SL

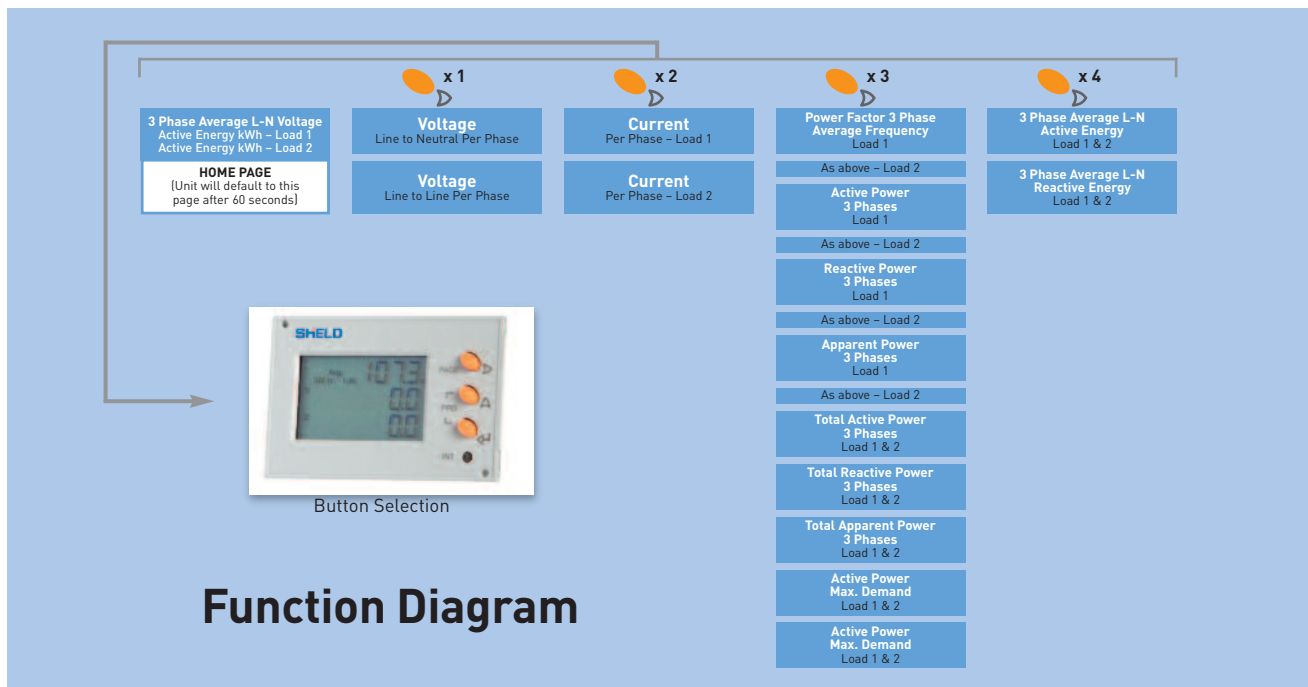

## Power Meter Dimensions

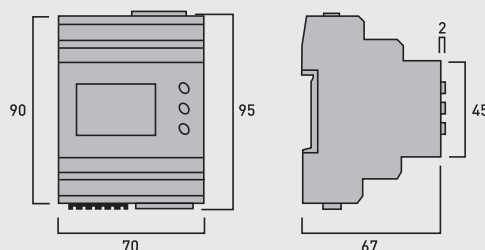

Please allow space above and below the meter for cable connections. Dimensions in mm.

## PAN Assemblies

A new range of **Panel Mounting PAN Assemblies** suitable for the following MCB ranges is introduced **8, 12 and 18 ways**.

The PAN assemblies accept the Chint **ASTA approved** B, C or D Curve 6 or 10KA MCBs, 6A - 40A B or C Curve RCBOs, they are supplied as standard with a 125A, 4 Pole Incomer.

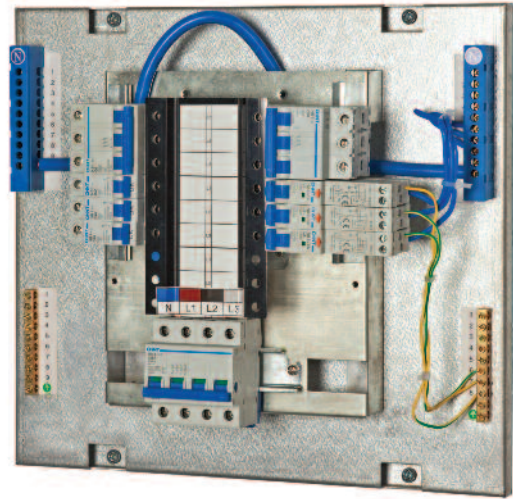

### Part Numbers and Dimensions for NXDB TP&N Boards, PAN Assemblies & Accessories

DESCRIPTION	PART NO.	HEIGHT	WIDTH	DEPTH
<b>3 PHASE TP&amp;N BOARDS – ALL METAL</b>				
4 Way	NXDB-4	600	500	155
6 Way	NXDB-6	700	500	155
8 Way	NXDB-8	735	500	155
12 Way	NXDB-12	850	500	155
18 Way	NXDB-18	1,000	500	155
<b>3 PHASE TP&amp;N BOARDS – GLAZED WINDOW</b>				
4 Way	NXDB-4G	600	500	155
6 Way	NXDB-6G	700	500	155
8 Way	NXDB-8G	735	500	155
12 Way	NXDB-12G	850	500	155
18 Way	NXDB-18G	1,000	500	155
<b>PANEL MOUNTING PAN ASSEMBLIES</b>				
8 Way PAN Assembly	PA-08	555	428	120
12 Way PAN Assembly	PA-12	715	428	120
18 Way PAN Assembly	PA-18	950	428	120
<b>ACCESSORIES</b>				
Spreader Box	EX-1803/SB	400	500	155
250A, 4P Incomer Unit with Cable Shrouds	EX-4250	400	500	155
Single Meter Kit	MRJ4M-LS01	-	-	-
Dual Meter Kit, Enclosure, Incomer & Cables	MRJ4M-LS02	400	500	155
18mm Blanking Plates (2 pieces)	NXDB-BP	-	-	-
3 Phase – Single Phasing Link	NXDB-LINK	-	-	-
Padlock and Fixing Kit	NXDB.LOCK	-	-	-

Pre assembled Metered Power and Lighting Boards and Meter Kits are available to order, see pages 12, 13 and 14.

## Power and Lighting Boards

The Chint solution to metering the output from individual 3 Phase Boards is both elegant and convenient and can be applied to all NXDB boards i.e. to Chint 4, 6, 8, 12 and 18 Way boards.

We can supply the following as kits for assembly on site, alternatively we are happy to assemble to suit specific applications based on our basic format as shown on the front cover.

Where we are asked to assemble boards to suit specific needs it is recommended that an initial telephone call is made to our office possibly followed by a site meeting. Please be aware that dependent on how the boards are to be configured site weight – handling will be a consideration.



### THE SINGLE BOARD KIT

Part No. MRJ4M-LS01 comprises:

- 1 x 3 Pole 1A MCB  
(Pt. no. NB1-63B3P01)
- 1 x Meter  
(Pt. no. MRJ4M-SL)
- 1 x Current Transformer  
(Pt. no. TAS242EW)
- 1 x Supply Cable  
(Pt. no. TASMVSC1.00)
- 1 x Communications Cable  
(Pt. no. L67 7010 RJ45)
- 2 x End Stops

### THE TWIN BOARD KIT

Part No. MRJ4M-LS02 comprises:

- 1 x 4 Pole Mains Splitter Box with  
125A, 4 Pole Incomer
- 2 x 3 Pole 1A MCBs  
(Pt. no. NB1-63B3P01)
- 2 x Meters  
(Pt. no. MRJ4M-SL)
- 2 x Current Transformers  
(Pt. no. TAS242EW)
- 2 x Supply Cables  
(Pt. no. TASMVSC1.00)
- 2 x Communications Cables  
(Pt. no. L67 7010 RJ45)
- 4 Pole Mains and Earth Interconnection  
Cables as appropriate

#### IMPORTANT NOTE:

When sizing the correct size of board be aware that the MCB feeding the meter etc., takes up 3 full Ways, thereby reducing the effective size of each board by 1, 3 way module, i.e. A 4 Way board becomes 3, 6 Way becomes 5 etc.

## Wiring Diagrams

There is a full range of **ASTA approved** B, C and D Curve MCBs and B and C Curve RCBs readily available to complement the **Chint NXDB TP&N Distribution Boards**.

Chint are happy to fully assemble the boards and metering systems and to fit the MCBs, RCBs etc., to customer specifications although handling of the equipment on site due to weight needs to be a consideration\*.

### SINGLE BOARD

Part No. MRJ4M-LS01

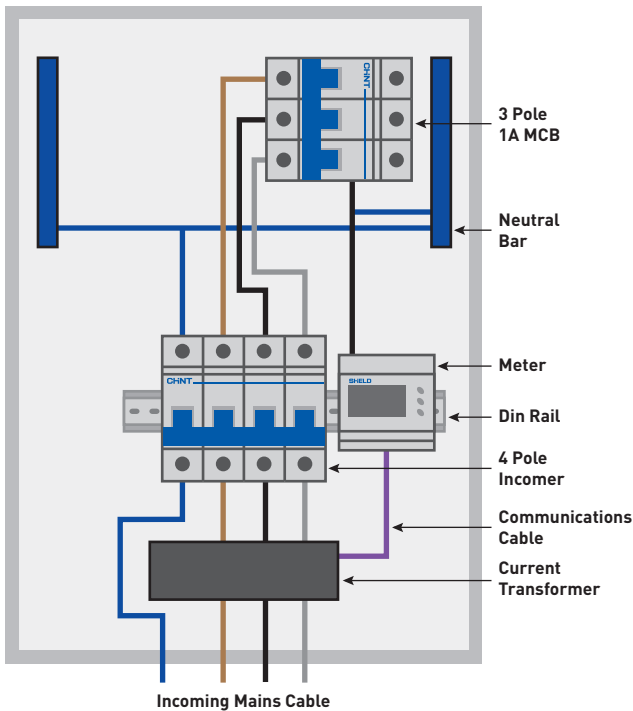

### TWIN BOARD

Part No. MRJ4M-LS02

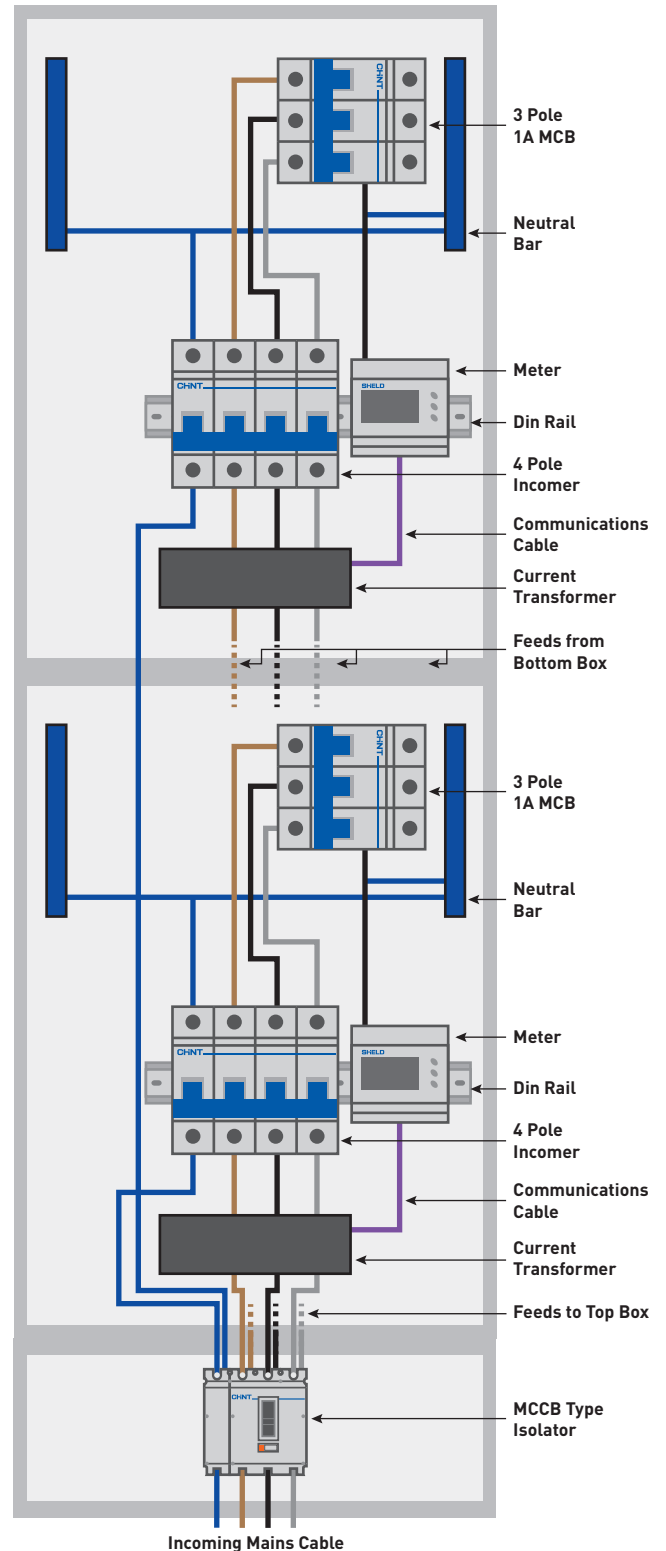

**\*PLEASE NOTE:**

Chint will take responsibility for shipping to an agreed UK location on appropriate pallets. Our carrier will offload to the roadside after which it will be Client's responsibility to transfer to the final location. **Carriage is charged extra.**

## NXDB MK III Options

Chint NXDB Distribution Boards can be supplied with all Metal covers or Plastic “see-through covers”, or a mixture of both to suit customers’ specifications.

The following part numbers are the most popular, although other variants can be supplied as required. Part numbers suffixed **MK**, i.e. **NXDB-4MK** are all metal construction and suffix **MKG**, i.e. **NXDB4MKG** are supplied with a plastic window.

Please speak with our sales office should you require a mixture.

All NXDB Boards are supplied prefitted with 4 Pole 125A Incomers with the main Neutral wired to appropriate Terminal Blocks.

### ALL METAL



PART NO.	APPROX. WEIGHT (KG)
NXDB-4MK	19
NXDB-6MK	21
NXDB-8MK	22
NXDB-12MK	24
NXDB-18MK	28
NXDB-44MK	48
NXDB-46MK	50
NXDB-48MK	51
NXDB-412MK	53
NXDB-418MK	57
NXDB-66MK	52
NXDB-68MK	53
NXDB-612MK	55
NXDB-618MK	59
NXDB-88MK	54
NXDB-812MK	56
NXDB-818MK	60
NXDB-1212MK	58
NXDB-1218MK	63
NXDB-1818MK	66

### GLAZED WINDOW



PART NO.	APPROX. WEIGHT (KG)
NXDB-4MKG	18
NXDB-6MKG	20
NXDB-8MKG	21
NXDB-12MKG	23
NXDB-18MKG	27
NXDB-44MKG	47
NXDB-46MKG	49
NXDB-48MKG	50
NXDB-412MKG	52
NXDB-418MKG	56
NXDB-66MKG	51
NXDB-68MKG	52
NXDB-612MKG	54
NXDB-618MKG	58
NXDB-88MKG	53
NXDB-812MKG	55
NXDB-818MKG	59
NXDB-1212MKG	57
NXDB-1218MKG	62
NXDB-1818MKG	65

## NM1T Enclosed MCCBs

MCCBs Independently Tested and Approved to IEC/EN 60947-2



- 3 Pole and 4 Pole with neutral
- Steel enclosure rated at IP66
- Ratings of MCCBs easily adjusted down by 20%
- MCCBs KEMA approved to 50KA
- Removable bottom gland plate
- Can be padlocked off

### 3P, NM1T ENCLOSED MCCBs (ALL WITH ISOLATING LINKS)

DESCRIPTION	PART NO.
32A, 3 Pole and Neutral	NM1T-32/3N
63A, 3 Pole and Neutral	NM1T-63/3N
125A, 3 Pole and Neutral	NM1T-125/3N
250A, 3 Pole and Neutral	NM1T-250/3N
400A, 3 Pole and Neutral	NM1T-400/3N
630A, 3 Pole and Neutral	NM1T-630/3N

### 4P, NM1T ENCLOSED MCCBs (ALL WITH ISOLATING LINKS)

DESCRIPTION	PART NO.
32A, 4 Pole and Neutral	NM1T-32/4N
63A, 4 Pole and Neutral	NM1T-63/4N
80A, 4 Pole and Neutral	NM1T-80/4N
100A, 4 Pole and Neutral	NM1T-100/4N
125A, 4 Pole and Neutral	NM1T-125/4N
200A, 4 Pole and Neutral	NM1T-200/4N
250A, 4 Pole and Neutral	NM1T-250/4N
400A, 4 Pole and Neutral	NM1T-400/4N
630A, 4 Pole and Neutral	NM1T-630/4N

## NM1TL Enclosed ELCB

MCCBs Independently Tested and Approved to IEC/EN 60947-2



- 3 Pole and 4 Pole with neutral
- Steel enclosure rated at IP66
- Ratings of MCCBs and RCDs can be easily adjusted
- MCCBs KEMA approved to 50KA
- Removable bottom gland plate
- Can be padlocked off
- Adjustable range for X1: (A) 0.05 - 0.1 - 0.2 - 0.5
- Adjustable range for T1: (s) 0.1 - 0.3 - 0.5 - 1

### 3P, NM1TL ENCLOSED ELCB

DESCRIPTION	PART NO.
63A, 3P Enclosed ELCB	NM1TL-063/3/X1/T1
100A, 3P Enclosed ELCB	NM1TL-100/3/X1/T1
160A, 3P Enclosed ELCB	NM1TL-160/3/X1/T1
200A, 3P Enclosed ELCB	NM1TL-200/3/X1/T1
250A, 3P Enclosed ELCB	NM1TL-250/3/X1/T1

### 4P, NM1TL ENCLOSED ELCB

DESCRIPTION	PART NO.
63A, 4P Enclosed ELCB	NM1TL-063/4/X1/T1
100A, 4P Enclosed ELCB	NM1TL-100/4/X1/T1
160A, 4P Enclosed ELCB	NM1TL-160/4/X1/T1
200A, 4P Enclosed ELCB	NM1TL-200/4/X1/T1
250A, 4P Enclosed ELCB	NM1TL-250/4/X1/T1

For dimensions please see pages 67 & 68

## Wall Mounted Metal Enclosures



- IP65 Suitable for indoor and outdoor use
- Removable bottom gland plate
- Removable door
- Earth studs on base, door and back plate
- Powder coated steel finish to RAL 7035
- Back plate manufactured from 2mm Zinc plated steel
- Sizes shown here are stock items.  
Many more sizes available to special order.

### 4P, METAL ENCLOSURES IP65

DESCRIPTION (in mm)	PART NO.
250h x 200w x 150d Empty Enc.	ENC-2520/15
300h x 250w x 150d Empty Enc.	ENC-3025/15
400h x 300w x 150d Empty Enc.	ENC-4030/15
500h x 400w x 150d Empty Enc.	ENC-5040/15
600h x 400w x 260d Empty Enc.	ENC-6040/26
700h x 500w x 260d Empty Enc.	ENC-7050/26
800h x 600w x 260d Empty Enc.	ENC-8060/26



## Single Phase Metal Consumer Units

- Total number of ways 8, 10, 12, 15, 18 and 20.  
(Deduct 2 ways for Incomer, RCD or DP Isolator)
- Surface **OR** Flush mount
- Drop-down see-through polycarbonate lids
- Knock outs are 30mm
- Supplied empty with loose Bus Bar, neutral connection and Isolator
- Metal units are ideal for use in Garages, Workshops and other industrial premises
- Ideal where Earth continuity for metal conduit. MICC cables are needed



NX2-10T



NX2-10T



NX2-10TF



NX2-10TF

### SINGLE PHASE METAL UNITS – SURFACE MOUNTED

DESCRIPTION	PART NO.
6 Way plus DP Isolator (i.e. 8 Way)	NX2-8T
8 Way plus DP Isolator (i.e. 10 Way)	NX2-10T
10 Way plus DP Isolator (i.e. 12 Way)	NX2-12T
13 Way plus DP Isolator (i.e. 15 Way)	NX2-15T
16 Way plus DP Isolator (i.e. 18 Way)	NX2-18T
18 Way plus DP Isolator (i.e. 20 Way)	NX2-20T

### SINGLE PHASE METAL UNITS – FLUSH MOUNTED

DESCRIPTION	PART NO.
6 Way plus DP Isolator (i.e. 8 Way)	NX2-8TF
8 Way plus DP Isolator (i.e. 10 Way)	NX2-10TF
10 Way plus DP Isolator (i.e. 12 Way)	NX2-12TF
13 Way plus DP Isolator (i.e. 15 Way)	NX2-15TF
16 Way plus DP Isolator (i.e. 18 Way)	NX2-18TF
18 Way plus DP Isolator (i.e. 20 Way)	NX2-20TF

For dimensions please see pages 67 & 68

## Chint Consumer Units

- CHINT Consumer Units and empty enclosures range from the 3 module enclosure A29800, through to the 18 module enclosures NX2-18A
- All units are manufactured in neutral coloured Flame Retardant Magnolia coloured ABS, with clear fully drop down Polycarbonate covers
- 1/4 turn quick release fasteners enable safe yet speedy access to the interiors and removable internal assemblies allow maximum wiring access
- \*\*Excellent cabling access points from the rear and all 4 sides allow for a neat installation using appropriate sized trunking\*\*

## Dual RCDs Consumer Units



NX2-18DSL-A

### DUAL RCDs CONSUMER UNITS

DESCRIPTION	PART NO.
8 Way 1 x 100A Main Switch & 2 x 63A 30mA RCD	NX2-14DSL-A
8 Way 1 x 100A Main Switch & 2 x 80A 30mA RCD	NX2-14DSL-H
12 Way 1 x 100A Main Switch & 2 x 63A 30mA RCD	NX2-18DSL-A
12 Way 1 x 100A Main Switch & 2 x 80A 30mA RCD	NX2-18DSL-H

- All the above can be easily modified to give High Integrity capability

## Split Load Consumer Units



NX2-18A

### SPLIT LOAD CONSUMER UNITS

DESCRIPTION	PART NO.
3*3 Consumer Unit with RCD & Isolator	NX2-10W
5*5 Consumer Unit with 63A RCD & Isolator	NX2-14A
5*5 Consumer Unit with 80A RCD & Isolator	NX2-14H
7*7 Consumer Unit with 63A RCD & Isolator	NX2-18A
7*7 Consumer Unit with 80A RCD & Isolator	NX2-18H

For dimensions please see pages 67 & 68

## Consumer Units



NX2-14M

### CONSUMER UNITS

DESCRIPTION	PART NO.
6 usable Ways with Isolator	NX2-8M
8 usable Ways with Isolator	NX2-10M
12 usable Ways with Isolator	NX2-14M
16 usable Ways with Isolator	NX2-18M

### RCD CONSUMER UNIT PRE-FITTED WITH 2P RCD 63A, 30Ma

DESCRIPTION	PART NO.
6 usable Ways	NX2-8RCD
8 usable Ways	NX2-10RCD
12 usable Ways	NX2-14RCD
16 usable Ways	NX2-18RCD

### ACCESSORIES FOR CONSUMER UNITS

DESCRIPTION	PART NO.
Blanking Plate (4 pcs)	NX2-BP
14 Way Bus Bar	BB14
18 Way Bus Bar	BB18

## Enclosures & Pre-Assembled Enclosures



NXW1-5



NXW1-3



A29800



A28600/2

### ENCLOSURES

DESCRIPTION	PART NO.
3 Module IP65 Enclosure with Clear Drop Down Lid	NXW1-3
5 Module IP65 Enclosure with Clear Drop Down Lid	NXW1-5
10 Way Consumer Unit (Empty Board)	NX2-10A

### PRE-ASSEMBLED ENCLOSURES

DESCRIPTION	PART NO.
SHOWER UNIT IP65 comes with 63A RCD & 40A MCB	A29800
GARAGE/OUTBUILDING UNIT IP65 comes with 63A RCD & 1*6A, 1*16A MCBs	A28600/2

For dimensions please see pages 67 & 68

## Pre-Assembled Consumer Units



NX2-18DSL-RH1

### PRE-ASSEMBLED CONSUMER UNITS

DESCRIPTION	PART NO.
5*5 Pre-Assembled Consumer Unit	NX2-14DSL-RH1
6*6 Pre-Assembled Consumer Unit	NX2-18DSL-RH1

## 28 & 36 Way Insulated Consumer Units

Double stacked Consumer Units offering maximum flexibility for large installations.

Both the top and bottom units are supplied with either 14 or 18 Way Bus Bars and 2 Interconnection cables with crimped ends allowing the boards to be

custom assembled to cater for a wide variety of protected and none protected ways.

Alternatively, the top unit can be used to house Bell Transformers, Contactors etc.



NX2-36A

### 28 & 36 WAY INSULATED CONSUMER UNITS

DESCRIPTION	PART NO.
Double Stacked 28 Way Consumer Unit	NX2-28A
Double Stacked 36 Way Consumer Unit	NX2-36A

- Rigid, flame proof UL94V0 ABS construction
- Neutral magnolia finish
- Complete with 1\* 100A DP Isolator, 2\* 80A RCD and 2\* Interconnection Cables
- Excellent cabling access
- 2 Drop-down see-through polycarbonate lids
- Circuit labels and Blanking Plates included

## Pre-Assembled Consumer Units

Manufactured from ULV0 Flame Retardant ABS

Easily removable front cover with fully drop down see-through lid

MCB mounting frame is easily removable to ease wiring

Rigid ABS base with ample cut outs and good wiring space

Smart installed appearance

## NB1 Series, 6KA Miniature Circuit Breakers

Independently Tested and Approved by:



NB1, 1P

1 POLE, 6KA				Boxed in 12s
In (A)	Pole	PART NUMBERS		
		B CURVE	C CURVE	D CURVE
1	1P	NB1-63B1P01	NB1-63C1P01	NB1-63D1P01
2	1P	NB1-63B1P02	NB1-63C1P02	NB1-63D1P02
3	1P	NB1-63B1P03	NB1-63C1P03	NB1-63D1P03
4	1P	NB1-63B1P04	NB1-63C1P04	NB1-63D1P04
6	1P	NB1-63B1P06	NB1-63C1P06	NB1-63D1P06
10	1P	NB1-63B1P10	NB1-63C1P10	NB1-63D1P10
16	1P	NB1-63B1P16	NB1-63C1P16	NB1-63D1P16
20	1P	NB1-63B1P20	NB1-63C1P20	NB1-63D1P20
25	1P	NB1-63B1P25	NB1-63C1P25	NB1-63D1P25
32	1P	NB1-63B1P32	NB1-63C1P32	NB1-63D1P32
40	1P	NB1-63B1P40	NB1-63C1P40	NB1-63D1P40
50	1P	NB1-63B1P50	NB1-63C1P50	NB1-63D1P50
63	1P	NB1-63B1P63	NB1-63C1P63	NB1-63D1P63



NB1, 2P

2 POLE, 6KA				Boxed in 6s
In (A)	Pole	PART NUMBERS		
		B CURVE	C CURVE	D CURVE
1	2P	NB1-63B2P01	NB1-63C2P01	NB1-63D2P01
2	2P	NB1-63B2P02	NB1-63C2P02	NB1-63D2P02
3	2P	NB1-63B2P03	NB1-63C2P03	NB1-63D2P03
4	2P	NB1-63B2P04	NB1-63C2P04	NB1-63D2P04
6	2P	NB1-63B2P06	NB1-63C2P06	NB1-63D2P06
10	2P	NB1-63B2P10	NB1-63C2P10	NB1-63D2P10
16	2P	NB1-63B2P16	NB1-63C2P16	NB1-63D2P16
20	2P	NB1-63B2P20	NB1-63C2P20	NB1-63D2P20
25	2P	NB1-63B2P25	NB1-63C2P25	NB1-63D2P25
32	2P	NB1-63B2P32	NB1-63C2P32	NB1-63D2P32
40	2P	NB1-63B2P40	NB1-63C2P40	NB1-63D2P40
50	2P	NB1-63B2P50	NB1-63C2P50	NB1-63D2P50
63	2P	NB1-63B2P63	NB1-63C2P63	NB1-63D2P63

## NB1 Series, 6KA Miniature Circuit Breakers

- 1 Pole: Boxed in 12s.
- 2 Pole: Boxed in 6s.
- 3 Pole: Boxed in 4s.
- 4 Pole: Boxed in 3s.



NB1, 3P

### 3 POLE, 6KA

Boxed in 4s

In (A)	Pole	PART NUMBERS		
		B CURVE	C CURVE	D CURVE
1	3P	NB1-63B3P01	NB1-63C3P01	NB1-63D3P01
2	3P	NB1-63B3P02	NB1-63C3P02	NB1-63D3P02
3	3P	NB1-63B3P03	NB1-63C3P03	NB1-63D3P03
4	3P	NB1-63B3P04	NB1-63C3P04	NB1-63D3P04
6	3P	NB1-63B3P06	NB1-63C3P06	NB1-63D3P06
10	3P	NB1-63B3P10	NB1-63C3P10	NB1-63D3P10
16	3P	NB1-63B3P16	NB1-63C3P16	NB1-63D3P16
20	3P	NB1-63B3P20	NB1-63C3P20	NB1-63D3P20
25	3P	NB1-63B3P25	NB1-63C3P25	NB1-63D3P25
32	3P	NB1-63B3P32	NB1-63C3P32	NB1-63D3P32
40	3P	NB1-63B3P40	NB1-63C3P40	NB1-63D3P40
50	3P	NB1-63B3P50	NB1-63C3P50	NB1-63D3P50
63	3P	NB1-63B3P63	NB1-63C3P63	NB1-63D3P63

### 4 POLE, 6KA

Boxed in 3s



NB1, 4P

In (A)	Pole	PART NUMBERS		
		B CURVE	C CURVE	D CURVE
1	4P	NB1-63B4P01	NB1-63C4P01	NB1-63D4P01
2	4P	NB1-63B4P02	NB1-63C4P02	NB1-63D4P02
3	4P	NB1-63B4P03	NB1-63C4P03	NB1-63D4P03
4	4P	NB1-63B4P04	NB1-63C4P04	NB1-63D4P04
6	4P	NB1-63B4P06	NB1-63C4P06	NB1-63D4P06
10	4P	NB1-63B4P10	NB1-63C4P10	NB1-63D4P10
16	4P	NB1-63B4P16	NB1-63C4P16	NB1-63D4P16
20	4P	NB1-63B4P20	NB1-63C4P20	NB1-63D4P20
25	4P	NB1-63B4P25	NB1-63C4P25	NB1-63D4P25
32	4P	NB1-63B4P32	NB1-63C4P32	NB1-63D4P32
40	4P	NB1-63B4P40	NB1-63C4P40	NB1-63D4P40
50	4P	NB1-63B4P50	NB1-63C4P50	NB1-63D4P50
63	4P	NB1-63B4P63	NB1-63C4P63	NB1-63D4P63

## NB1 Series, 10KA Miniature Circuit Breakers

Independently Tested and Approved by:



NB1, 1P

1 POLE, 10KA					Boxed in 12s
In (A)	Pole	PART NUMBERS			
		B CURVE	C CURVE	D CURVE	
1	1P	NB1-63BH1P01	NB1-63CH1P01	NB1-63DH1P01	
2	1P	NB1-63BH1P02	NB1-63CH1P02	NB1-63DH1P02	
3	1P	NB1-63BH1P03	NB1-63CH1P03	NB1-63DH1P03	
4	1P	NB1-63BH1P04	NB1-63CH1P04	NB1-63DH1P04	
6	1P	NB1-63BH1P06	NB1-63CH1P06	NB1-63DH1P06	
10	1P	NB1-63BH1P10	NB1-63CH1P10	NB1-63DH1P10	
16	1P	NB1-63BH1P16	NB1-63CH1P16	NB1-63DH1P16	
20	1P	NB1-63BH1P20	NB1-63CH1P20	NB1-63DH1P20	
25	1P	NB1-63BH1P25	NB1-63CH1P25	NB1-63DH1P25	
32	1P	NB1-63BH1P32	NB1-63CH1P32	NB1-63DH1P32	
40	1P	NB1-63BH1P40	NB1-63CH1P40	NB1-63DH1P40	
50	1P	NB1-63BH1P50	NB1-63CH1P50	NB1-63DH1P50	
63	1P	NB1-63BH1P63	NB1-63CH1P63	NB1-63DH1P63	



NB1, 2P

2 POLE, 10KA					Boxed in 6s
In (A)	Pole	PART NUMBERS			
		B CURVE	C CURVE	D CURVE	
1	2P	NB1-63BH2P01	NB1-63CH2P01	NB1-63DH2P01	
2	2P	NB1-63BH2P02	NB1-63CH2P02	NB1-63DH2P02	
3	2P	NB1-63BH2P03	NB1-63CH2P03	NB1-63DH2P03	
4	2P	NB1-63BH2P04	NB1-63CH2P04	NB1-63DH2P04	
6	2P	NB1-63BH2P06	NB1-63CH2P06	NB1-63DH2P06	
10	2P	NB1-63BH2P10	NB1-63CH2P10	NB1-63DH2P10	
16	2P	NB1-63BH2P16	NB1-63CH2P16	NB1-63DH2P16	
20	2P	NB1-63BH2P20	NB1-63CH2P20	NB1-63DH2P20	
25	2P	NB1-63BH2P25	NB1-63CH2P25	NB1-63DH2P25	
32	2P	NB1-63BH2P32	NB1-63CH2P32	NB1-63DH2P32	
40	2P	NB1-63BH2P40	NB1-63CH2P40	NB1-63DH2P40	
50	2P	NB1-63BH2P50	NB1-63CH2P50	NB1-63DH2P50	
63	2P	NB1-63BH2P63	NB1-63CH2P63	NB1-63DH2P63	



## NB1 Series, 10KA Miniature Circuit Breakers

- 1 Pole: Boxed in 12s.
- 2 Pole: Boxed in 6s.
- 3 Pole: Boxed in 4s.
- 4 Pole: Boxed in 3s.



NB1, 3P

### 3 POLE, 10KA

Boxed in 4s

In (A)	Pole	PART NUMBERS		
		B CURVE	C CURVE	D CURVE
1	3P	NB1-63BH3P01	NB1-63CH3P01	NB1-63DH3P01
2	3P	NB1-63BH3P02	NB1-63CH3P02	NB1-63DH3P02
3	3P	NB1-63BH3P03	NB1-63CH3P03	NB1-63DH3P03
4	3P	NB1-63BH3P04	NB1-63CH3P04	NB1-63DH3P04
6	3P	NB1-63BH3P06	NB1-63CH3P06	NB1-63DH3P06
10	3P	NB1-63BH3P10	NB1-63CH3P10	NB1-63DH3P10
16	3P	NB1-63BH3P16	NB1-63CH3P16	NB1-63DH3P16
20	3P	NB1-63BH3P20	NB1-63CH3P20	NB1-63DH3P20
25	3P	NB1-63BH3P25	NB1-63CH3P25	NB1-63DH3P25
32	3P	NB1-63BH3P32	NB1-63CH3P32	NB1-63DH3P32
40	3P	NB1-63BH3P40	NB1-63CH3P40	NB1-63DH3P40
50	3P	NB1-63BH3P50	NB1-63CH3P50	NB1-63DH3P50
63	3P	NB1-63BH3P63	NB1-63CH3P63	NB1-63DH3P63

### 4 POLE, 10KA

Boxed in 3s



NB1, 4P

In (A)	Pole	PART NUMBERS		
		B CURVE	C CURVE	D CURVE
1	4P	NB1-63BH4P01	NB1-63CH4P01	NB1-63DH4P01
2	4P	NB1-63BH4P02	NB1-63CH4P02	NB1-63DH4P02
3	4P	NB1-63BH4P03	NB1-63CH4P03	NB1-63DH4P03
4	4P	NB1-63BH4P04	NB1-63CH4P04	NB1-63DH4P04
6	4P	NB1-63BH4P06	NB1-63CH4P06	NB1-63DH4P06
10	4P	NB1-63BH4P10	NB1-63CH4P10	NB1-63DH4P10
16	4P	NB1-63BH4P16	NB1-63CH4P16	NB1-63DH4P16
20	4P	NB1-63BH4P20	NB1-63CH4P20	NB1-63DH4P20
25	4P	NB1-63BH4P25	NB1-63CH4P25	NB1-63DH4P25
32	4P	NB1-63BH4P32	NB1-63CH4P32	NB1-63DH4P32
40	4P	NB1-63BH4P40	NB1-63CH4P40	NB1-63DH4P40
50	4P	NB1-63BH4P50	NB1-63CH4P50	NB1-63DH4P50
63	4P	NB1-63BH4P63	NB1-63CH4P63	NB1-63DH4P63

## eBG Series, MCBs

Independently Tested and Approved by:



EBG, 1P

1 POLE, 6KA		Boxed in 12s
B CURVE	PART NO.	
6A, 1P	EBG-1P-B06	
10A, 1P	EBG-1P-B10	
16A, 1P	EBG-1P-B16	
20A, 1P	EBG-1P-B20	
32A, 1P	EBG-1P-B32	
40A, 1P	EBG-1P-B40	

## NBH8 Series, 1P+N MCBs

Independently Tested and Approved by:



1 Pole: Boxed in 12s.

- Live and Neutral in an 18mm wide device
- B and C curves
- 1A – 40A



NBH8-40, 1P

NBH8 1P+N MCBs	
B CURVE	PART NO.
1A	NBH8-40-B01
2A	NBH8-40-B02
3A	NBH8-40-B03
4A	NBH8-40-B04
6A	NBH8-40-B06
10A	NBH8-40-B10
16A	NBH8-40-B16
20A	NBH8-40-B20
25A	NBH8-40-B25
32A	NBH8-40-B32
40A	NBH8-40-B40

NBH8 1P+N MCBs	
C CURVE	PART NO.
1A	NBH8-40-C01
2A	NBH8-40-C02
3A	NBH8-40-C03
4A	NBH8-40-C04
6A	NBH8-40-C06
10A	NBH8-40-C10
16A	NBH8-40-C16
20A	NBH8-40-C20
25A	NBH8-40-C25
32A	NBH8-40-C32
40A	NBH8-40-C40

## DZ158 Series, High Current MCBs

Independently Tested and Approved by:



- 1 Pole 27mm wide
- 2 Pole 54mm wide
- 3 Pole 81mm wide
- 4 Pole 108mm wide



DZ158, 1P



DZ158, 2P

### 1 POLE, HIGH CURRENT MCBs Boxed in 12s

DESCRIPTION	PART NO.
63A, 1P	DZ158-1-63A
80A, 1P	DZ158-1-80A
100A, 1P	DZ158-1-100A
125A, 1P	DZ158-1-125A

### 2 POLE, HIGH CURRENT MCBs Boxed in 6s

DESCRIPTION	PART NO.
63A, 2P	DZ158-2-63A
80A, 2P	DZ158-2-80A
100A, 2P	DZ158-2-100A
125A, 2P	DZ158-2-125A



DZ158, 3P



DZ158, 4P

### 3 POLE, HIGH CURRENT MCBs Boxed in 4s

DESCRIPTION	PART NO.
63A, 3P	DZ158-3-63A
80A, 3P	DZ158-3-80A
100A, 3P	DZ158-3-100A
125A, 3P	DZ158-3-125A

### 4 POLE, HIGH CURRENT MCBs Boxed in 3s

DESCRIPTION	PART NO.
63A, 4P	DZ158-4-63A
80A, 4P	DZ158-4-80A
100A, 4P	DZ158-4-100A
125A, 4P	DZ158-4-125A

## NL1 Series, Residual Current Devices

Independently Tested and Approved by:



NL1-63-2P



NL1-63-4P

### RCD, 2 POLE, AC TYPE

DESCRIPTION	PART NO.
25A 30mA, 2P	NL1-63-225/30
25A 100mA, 2P	NL1-63-225/100
25A 300mA, 2P	NL1-63-225/300
40A 30mA, 2P	NL1-63-240/30
40A 100mA, 2P	NL1-63-240/100
40A 300mA, 2P	NL1-63-240/300
63A 30mA, 2P	NL1-63-263/30
63A 100mA, 2P	NL1-63-263/100
63A 300mA, 2P	NL1-63-263/300
80A 30mA, 2P	NL1-100-280/30
80A 100mA, 2P	NL1-100-280/100
80A 300mA, 2P	NL1-100-280/300
100A 30mA, 2P	NL1-100-2100/30
100A 100mA, 2P	NL1-100-2100/100
100A 300mA, 2P	NL1-100-2100/300

### RCD, 4 POLE, AC TYPE

DESCRIPTION	PART NO.
25A 30mA, 4P	NL1-63-425/30
25A 100mA, 4P	NL1-63-425/100
25A 300mA, 4P	NL1-63-425/300
40A 30mA, 4P	NL1-63-440/30
40A 100mA, 4P	NL1-63-440/100
40A 300mA, 4P	NL1-63-440/300
63A 30mA, 4P	NL1-63-463/30
63A 300mA, 4P	NL1-63-463/300
80A 30mA, 4P	NL1-63-480/30
80A 100mA, 4P	NL1-63-480/100
80A 300mA, 4P	NL1-63-480/300
100A 100mA, 4P	NL1-100-4100/100
100A 300mA, 4P	NL1-100-4100/300

### RCD, 2 POLE, A TYPE

DESCRIPTION	PART NO.
63A 30mA, 2P	NL1-63-263/30-A



NL1-100

- Chint 100mA Time Delayed RCDs are used where total RCD protection is required to supplement the system earthing and where local 30mA RCDs are used to provide additional protection against direct contact
- The 300mA Time Delayed RCD will discriminate against the standard 30mA RCD
- Independently tested and approved to EN61008-1

### TIME DELAY RCDs

DESCRIPTION	PART NO.
80A 100mA, 2P	NL1-100-280/100-S
80A 100mA, 4P	NL1-100-480/100-S
100A 100mA, 2P	NL1-100-2100/100-S

## RCBOs



NB3LEU



NB3LE

### NB3LEU, 10KA RCBO

DESCRIPTION	B CURVE	C CURVE
6A 30mA	NB3LEU-B06	NB3LEU-C06
10A 30mA	NB3LEU-B10	NB3LEU-C10
16A 30mA	NB3LEU-B16	NB3LEU-C16
20A 30mA	NB3LEU-B20	NB3LEU-C20
25A 30mA	NB3LEU-B25	NB3LEU-C25
32A 30mA	NB3LEU-B32	NB3LEU-C32
40A 30mA	NB3LEU-B40	NB3LEU-C40

### NB3LE, 6KA RCBO

DESCRIPTION	B CURVE	C CURVE
6A 30mA	NB3LE-B06	NB3LE-C06
10A 30mA	NB3LE-B10	NB3LE-C10
16A 30mA	NB3LE-B16	NB3LE-C16
20A 30mA	NB3LE-B20	NB3LE-C20
25A 30mA	NB3LE-B25	NB3LE-C25
32A 30mA	NB3LE-B32	NB3LE-C32



NB310L



NB2LE

### NB310L, 2P (36mm wide) RCBO

DESCRIPTION	B CURVE	C CURVE
6A 30mA	NB310L-B06	NB310L-C06
10A 30mA	NB310L-B10	NB310L-C10
16A 30mA	NB310L-B16	NB310L-C16
20A 30mA	NB310L-B20	NB310L-C20
25A 30mA	NB310L-B25	NB310L-C25
32A 30mA	NB310L-B32	NB310L-C32

### NB2LE, 1P+N (18mm wide) RCBO

DESCRIPTION	B CURVE	C CURVE
6A 30mA	NB2LE-B06	NB2LE-C06
10A 30mA	NB2LE-B10	NB2LE-C10
16A 30mA	NB2LE-B16	NB2LE-C16
20A 30mA	NB2LE-B20	NB2LE-C20
25A 30mA	NB2LE-B25	NB2LE-C25

## RCBOs

Independently Tested and Approved by:



NB1L 1P+N



NB1L-4P-C20

### NB1L, 1P+N (36mm wide) RCBO

DESCRIPTION	B CURVE	C CURVE
6A 30mA	NB1L-B06	NB1L-C06
10A 30mA	NB1L-B10	NB1L-C10
16A 30mA	NB1L-B16	NB1L-C16
20A 30mA	NB1L-B20	NB1L-C20
25A 30mA	NB1L-B25	NB1L-C25
32A 30mA	NB1L-B32	NB1L-C32
40A 30mA	NB1L-B40	NB1L-C40

### NB1L, 3P+N (72mm wide) RCBO

DESCRIPTION	B CURVE	C CURVE
6A 30mA	NB1L-4P-B06	NB1L-4P-C06
10A 30mA	NB1L-4P-B10	NB1L-4P-C10
16A 30mA	NB1L-4P-B16	NB1L-4P-C16
20A 30mA	NB1L-4P-B20	NB1L-4P-C20
25A 30mA	NB1L-4P-B25	NB1L-4P-C25
32A 30mA	NB1L-4P-B32	NB1L-4P-C32
40A 30mA	NB1L-4P-B40	NB1L-4P-C40

### NB1L, 2 POLE (54mm wide) RCBO

DESCRIPTION	B CURVE	C CURVE
32A 30mA	NB1L-2P-B32	NB1L-2P-C32
40A 30mA	NB1L-2P-B40	NB1L-2P-C40

## NH4 Isolators

Independently Tested and Approved by:



- 1 Pole: Boxed in 12s.
- 2 Pole: Boxed in 6s.
- 3 Pole: Boxed in 4s.
- 4 Pole: Boxed in 3s.



NH4-80208



NH4-80408

### NH4 ISOLATORS

DESCRIPTION	PART NO.
100A, 1P	NH4-80108
100A, 2P	NH4-80208
100A, 3P	NH4-80308
100A, 4P	NH4-80408
125A, 1P	NH4-90108
125A, 2P	NH4-90208
125A, 3P	NH4-90308
125A, 4P	NH4-90408

## Enclosed Rotary Isolators



SRS-432



SDS-63

- 3 or 4 switched Poles
- IP65
- 32A, 3 and 4 Pole
- 63A, 3 and 4 Pole
- 100A, 2 and 4 Pole
- Up to 3 "Lock Off Padlocks" can be fitted to any device

### ENCLOSED ROTARY ISOLATORS

DESCRIPTION	PART NO.
20A, 3 Pole	SRS-320
32A, 3 Pole	SRS-332
63A, 3 Pole	SRS-363
100A, 3 Pole	SRS-3100
20A, 4 Pole	SRS-420
32A, 4 Pole	SRS-432
63A, 4 Pole	SRS-463
100A, 4 Pole	SRS-4100

### DC ISOLATOR IP65

DESCRIPTION	PART NO.
16A, DC Isolator IP65	SDS-16
25A, DC Isolator IP65	SDS-25
63A, DC Isolator IP65	SDS-63

For dimensions please see pages 67 & 68

## MCB Accessories

CE



XF9



XF9J



S9



V9



AX1



BB01



BB01/F

### AUXILIARIES FOR NB1, NBH8, NB3LEU, NB3LE & NB1L

DESCRIPTION	PART NO.
Auxiliary Contacts	XF9
C/O Alarm Auxiliary Contact	XF9J
230V Shunt Trip	S9
230V Under Voltage Release	V9
MCB Lock	CB14

### AUXILIARIES FOR HIGH CURRENT MCBs

DESCRIPTION	PART NO.
1 NO + 1 NC Aux. Switch (for DZ158s)	AX-1

### BUS BAR (per 1 metre length)

DESCRIPTION	PART NO.
1 Pole MCB Pin Bus Bar	BB01
1 Pole MCB Fork Bus Bar	BB01/F
2 Pole MCB Pin Bus Bar	BB02
2 Pole MCB Fork Bus Bar	BB02/F
3 Pole MCB Pin Bus Bar	BB03
3 Pole MCB Fork Bus Bar	BB03/F
End Caps to suit BB01	BB01/FE
End Caps to suit BB02	BB02/FE
End Caps to suit BB03	BB03/FE
1 Pole Pin Bus Bar for NBH8	BB01-63



DR1

### 35mm TOP HAT SECTION DIN RAIL

DESCRIPTION	PART NO.
1m length Din Rail	DR1
2m length Din Rail	DR2

- Available in 1m and 2m stock lengths with 6mm wide centre slots



## 2 Gang RCD Sockets

CE



NE2RCD-13A



NE2RCD-13A(M)

### 2 GANG RCD SOCKET – PLASTIC

DESCRIPTION	PART NO.
2 Gang RCD Plastic Socket	NE2RCD-13A

### 2 GANG RCD SOCKET – METAL

DESCRIPTION	PART NO.
2 Gang RCD Metal Socket	NE2RCD-13A(M)

## NCH8 Modular AC Contactors

CE



NCH8-20



NCH8-4P-63

- 2 and 4 NO main poles
- 230V AC coils
- 20A and 63A
- Quiet operation

### 2 POLE, MODULAR AC CONTACTORS

DESCRIPTION	PART NO.
2 Pole 20A 2 NO, 230V AC Coil	NCH8-20
2 Pole 20A 2 NC, 230V AC Coil	NCH8-20-02

### 4 POLE, MODULAR AC CONTACTORS

DESCRIPTION	PART NO.
4 Pole 40A 4 NO, 230V AC Coil	NCH8-4P-40
4 Pole 63A 4 NC, 230V AC Coil	NCH8-4P-63

## Bell Transformer

CE



SBT-16

- 230V, 50Hz input
- 6V, 9V, 12V, 24V output

### BELL TRANSFORMER

DESCRIPTION	PART NO.
Din Rail Mounted Bell Transformer	SBT-16

## Surge Arrestor

CE



NU6-II-25KA-1P



NU6-II-25KA-2P



NU6-II-25KA-3P



NU6-II-25KA-4P

### SURGE ARRESTOR

#### DESCRIPTION

#### PART NO.

25KA, 1 Pole Surge Arrestor

NU6-II-25KA-1P

25KA, 2 Pole Surge Arrestor

NU6-II-25KA-2P

25KA, 3 Pole Surge Arrestor

NU6-II-25KA-3P

25KA, 4 Pole Surge Arrestor

NU6-II-25KA-4P

## SDTS Digital Programmable Timer

CE



SDTS-15



- 7 day, 24 hr Digital Timer
- 16A lth (8)A 220 – 240V
- 2000W lamp load
- SPDT switch
- DIN Rail mounted
- Lithium back up battery
- Maximum width 36mm

### PROGRAMMABLE TIMER

#### DESCRIPTION

#### PART NO.

SPDT Timer

SDTS-15

## NTE8 Electronic Timer

CE



NTE8

### NTE8 ELECTRONIC TIMER

DESCRIPTION	PART NO.
1 NO Contact, 0.1-10 Secs. OFF DELAY	NTE8-10A
1 NO Contact, 10-120 Secs. OFF DELAY	NTE8-120A
1 NO Contact, 30-480 Secs. OFF DELAY	NTE8-480A
1 NO Contact, 0.1-10 Secs. ON DELAY	NTE8-10B
1 NO Contact, 10-120 Secs. ON DELAY	NTE8-120B
1 NO Contact, 30-480 Secs. ON DELAY	NTE8-480B

## NJS3 Staircase Timer

CE



NJS3

### NJS3 STAIRCASE TIMER

DESCRIPTION	PART NO.
AC 230V 30 Secs - 20 Mins, INTERVAL DELAY	NJS3-AC230V

## NJMC1 Series, Impulse Relay

CE



NJMC1-16/1P

- 16A
- 32A
- AC 230V
- DC 24V
- Ideal for halogen lighting

### NJMC1 SERIES IMPULSE RELAY

DESCRIPTION	PART NO.
16A, 1 Pole, AC 230V	NJMC1-16/1P-AC230V
16A, 2 Pole, AC 230V	NJMC1-16/2P-AC230V
16A, 3 Pole, AC 230V	NJMC1-16/3P-AC230V
16A, 4 Pole, AC 230V	NJMC1-16/4P-AC230V
32A, 1 Pole, AC 230V	NJMC1-32/1P-AC230V
32A, 2 Pole, AC 230V	NJMC1-32/2P-AC230V
32A, 3 Pole, AC 230V	NJMC1-32/3P-AC230V
32A, 4 Pole, AC 230V	NJMC1-32/4P-AC230V
16A, 1 Pole, DC 24V	NJMC1-16/1P-DC24V
16A, 2 Pole, DC 24V	NJMC1-16/2P-DC24V
16A, 3 Pole, DC 24V	NJMC1-16/3P-DC24V
16A, 4 Pole, DC 24V	NJMC1-16/4P-DC24V
32A, 1 Pole, DC 24V	NJMC1-32/1P-DC24V
32A, 2 Pole, DC 24V	NJMC1-32/2P-DC24V
32A, 3 Pole, DC 24V	NJMC1-32/3P-DC24V
32A, 4 Pole, DC 24V	NJMC1-32/4P-DC24V

# RDC Earth Leakage Relay

CE



RDC-02



RDC-11

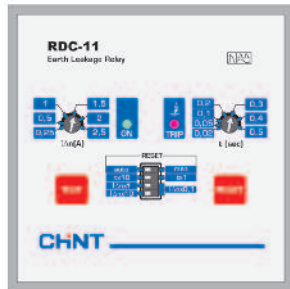

RDC-11 Front panel

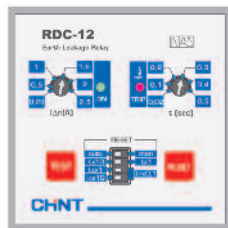

RDC-12 Front panel

RCD-02 features:

- Sensibility: from 0.025A to 25A, adjustable
- Trip delay: 0.02 sec., to 5 sec., adjustable
- Rated voltage 50/60Hz: 110VAC/VDC, 230/400VAC
- LED indications: ON and tripped
- Output relay: Normally open (NO)
- Output contacts: 1 NO/NC

## EARTH LEAKAGE RELAY

### DESCRIPTION

### PART NO.

DIN Rail mounted 3 modules,

RDC-02

Power supply:

110-230-400 VAC or

24...48 VAC/DC

Flush mounted 96 x 96mm,

RDC-11

Power supply:

110-230-400 VAC or

24...48 VAC/DC

Flush mounted 72 x 72 mm,

RDC-12

Power supply:

110-230-400 VAC or

24...48 VAC/DC

# TTC Transformers

CE

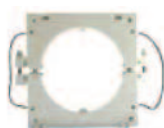

TTC

## TTC TRANSFORMERS

### DESCRIPTION

### PART NO.

Transformer – 3 modules,

TTC-028D

28mm diameter

Transformer (35mm)

TTC-035

Transformer (60mm)

TTC-060

Transformer (80mm)

TTC-080

## NDK Control Circuit Transformers

Independently Tested and Approved to IEC/ EN61558

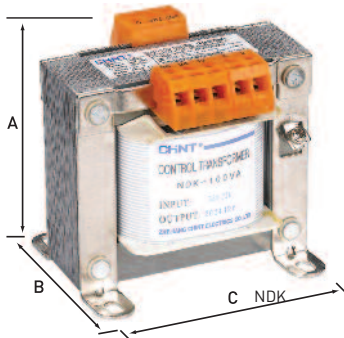

- Designed to offer maximum voltage ratings from minimum frame sizes, the NDK range is ideally suited to stockists allowing them to hold minimum stocks whilst still covering the majority of popular applications.
- Particularly aimed at Control Panel manufacturers, the NDK series is stocked in the UK in VA sizes from 50VA – 1000VA, other sizes up to a maximum of 5000VA are available to special order.

NDK CONTROL CIRCUIT TRANSFORMERS		
CAP.	DESCRIPTION	PART NO.
50VA	INPUT: 240V/415V	NDK-50
100VA		NDK-100
150VA		NDK-150
200VA	OUTPUT: 12V/24V 48V/110V 240V	NDK-200
250VA		NDK-250
300VA		NDK-300
400VA	FREQUENCY: 50Hz/60Hz	NDK-400
500VA		NDK-500
1000VA		NDK-1000

For dimensions please see pages 67 & 68

## YBLX Limit Switches

Designed to the requirements of IEC 60947-5-1



- SPDT switch contacts
- Head can be rotated
- 1 NO + 1 NC, 5A Ith Contacts
- Rugged die cast construction
- Various operators

YBLX LIMIT SWITCHES	
DESCRIPTION	PART NO.
Limit Switch	YBLX-ME/8104
Limit Switch	YBLX-CK/J10541
Limit Switch	YBLX-CK/J10559
Limit Switch	YBLX-CK/M115
Limit Switch	YBLX-CK/J10511
Limit Switch	YBLX-CK/J167
Limit Switch	YBLX-CK/J161
Limit Switch	YBLX-JW2-11Z/3
Limit Switch	YBLX-K1/41
Limit Switch	YBLX-P1/120/ID

Please contact Chint for more variations.

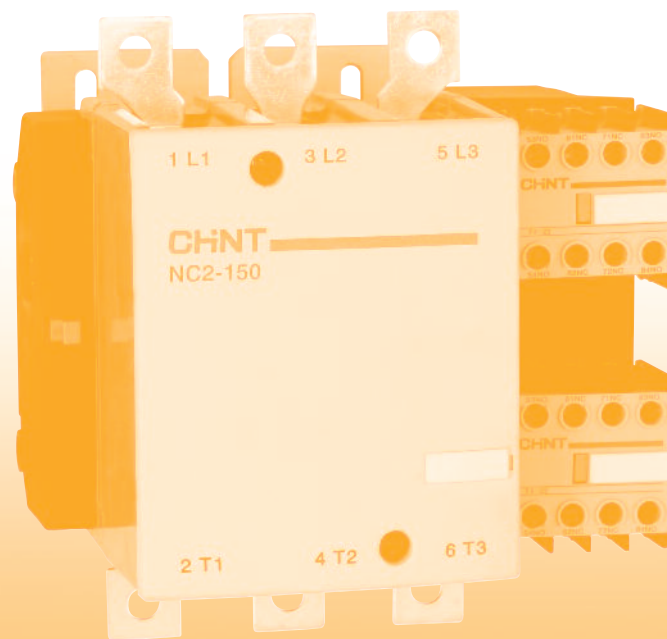

# MOTOR CONTROL GEAR COMPONENTS

## AC Coil Contactors, 3 & 4 Main Poles

Independently Tested and Approved by:



NC6



NC1

### To Order Contactors:

Please specify Part Number plus Coil Voltage:  
24VAC, 48VAC, 110VAC, 230VAC, 415VAC

### NC6 Series, 3P & 4P

DESCRIPTION	AC1	AC3	KW	PART NO.
3 NO Main + 1NO Aux	20A	9A	4.00	NC6-0910
3 NO Main + 1NC Aux	20A	9A	4.00	NC6-0901
4 NO Main Poles	20A	9A	4.00	NC6-0904
2 NO + 2 NC Main Poles	20A	9A	4.00	NC6-0908

### NC1 Series, 3P

DESCRIPTION	AC1	AC3	KW	PART NO.
<b>3 MAIN &amp; 1 NO AUXILIARY CONTACT</b>				
3 Main + 1 NO Aux	20A	9A	4.00	NC1-0910
3 Main + 1 NO Aux	20A	12A	5.50	NC1-1210
3 Main + 1 NO Aux	32A	18A	7.50	NC1-1810
3 Main + 1 NO Aux	40A	25A	11.00	NC1-2510
3 Main + 1 NO Aux	50A	32A	15.00	NC1-3210
<b>3 MAIN &amp; 1 NC AUXILIARY CONTACT</b>				
3 Main + 1 NC Aux	20A	9A	4.00	NC1-0901
3 Main + 1 NC Aux	20A	12A	5.50	NC1-1201
3 Main + 1 NC Aux	32A	18A	7.50	NC1-1801
3 Main + 1 NC Aux	40A	25A	11.00	NC1-2501
3 Main + 1 NC Aux	50A	32A	15.00	NC1-3201
<b>3 MAIN &amp; 1 NO + 1 NC AUXILIARY CONTACT</b>				
3 Main + 1 NO + 1 NC Aux	60A	40A	18.50	NC1-4011
3 Main + 1 NO + 1 NC Aux	80A	50A	22.00	NC1-5011
3 Main + 1 NO + 1 NC Aux	110A	65A	30.00	NC1-6511
3 Main + 1 NO + 1 NC Aux	110A	85A	37.00	NC1-8011
3 Main + 1 NO + 1 NC Aux	110A	95A	45.00	NC1-9511



## AC Coil Contactors, 3 & 4 Main Poles



NC1

### NC1 Series, 4P

DESCRIPTION	AC1	AC3	KW	PART NO.
<b>4 NO MAIN POLES</b>				
4 NO Main Poles	20A	9A	4.00	NC1-0904
4 NO Main Poles	20A	12A	5.50	NC1-1204
4 NO Main Poles	40A	25A	11.00	NC1-2504
4 NO Main Poles	60A	40A	18.50	NC1-4004
4 NO Main Poles	80A	50A	22.00	NC1-5004
4 NO Main Poles	80A	65A	30.00	NC1-6504
4 NO Main Poles	110A	80A	37.00	NC1-8004
4 NO Main Poles	110A	95A	45.00	NC1-9504
<b>4 MAIN POLES (2 NO &amp; 2 NC)</b>				
2 NO + 2 NC Main Poles	20A	9A	4.00	NC1-0908
2 NO + 2 NC Main Poles	20A	12A	5.50	NC1-1208
2 NO + 2 NC Main Poles	40A	25A	11.00	NC1-2508
2 NO + 2 NC Main Poles	60A	40A	18.50	NC1-4008
2 NO + 2 NC Main Poles	80A	50A	22.00	NC1-5008
2 NO + 2 NC Main Poles	80A	65A	30.00	NC1-6508
2 NO + 2 NC Main Poles	110A	80A	37.00	NC1-8008
2 NO + 2 NC Main Poles	110A	95A	45.00	NC1-9508

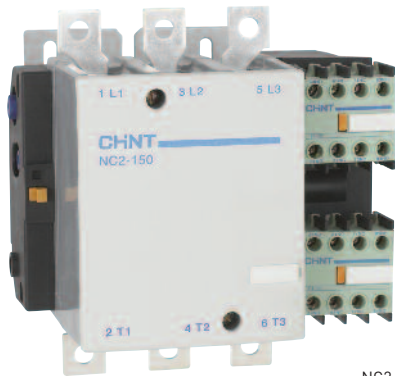

NC2

### NC2 Series, 3P & 4P

DESCRIPTION	AC1	AC3	KW	PART NO.
<b>3 NO MAIN POLES</b>				
3 NO Main Poles	200A	115A	55KW	NC2-115
3 NO Main Poles	200A	150A	75KW	NC2-150
3 NO Main Poles	275A	185A	90KW	NC2-185
3 NO Main Poles	275A	225A	110KW	NC2-225
3 NO Main Poles	315A	265A	132KW	NC2-265
3 NO Main Poles	380A	330A	160KW	NC2-330
3 NO Main Poles	450A	400A	200KW	NC2-400
3 NO Main Poles	630A	500A	250KW	NC2-500
3 NO Main Poles	800A	630A	335KW	NC2-630
<b>4 NO MAIN POLES</b>				
4 NO Main Poles	200A	115A	55KW	NC2-11504
4 NO Main Poles	200A	150A	75KW	NC2-15004
4 NO Main Poles	275A	185A	90KW	NC2-18504
4 NO Main Poles	275A	225A	110KW	NC2-22504
4 NO Main Poles	315A	265A	132KW	NC2-26504
4 NO Main Poles	380A	330A	160KW	NC2-33004
4 NO Main Poles	450A	400A	200KW	NC2-40004
4 NO Main Poles	800A	630A	335KW	NC2-63004

## DC Coil Contactors

CE



NC1-0910Z

### DC COIL CONTACTORS

DESCRIPTION	ELECT. RATING	PART NO.
3 Main + 1 NO Aux	20A AC1, 9A AC3	NC1-0910Z
3 Main + 1 NC Aux	20A AC1, 9A AC3	NC1-0901Z
3 Main + 1 NO Aux	20A AC1, 12A AC3	NC1-1210Z
3 Main + 1 NC Aux	20A AC1, 12A AC3	NC1-1201Z
3 Main + 1 NO Aux	32A AC1, 18A AC3	NC1-1810Z
3 Main + 1 NC Aux	32A AC1, 18A AC3	NC1-1801Z
3 Main + 1 NO Aux	40A AC1, 25A AC3	NC1-2510Z
3 Main + 1 NC Aux	40A AC1, 25A AC3	NC1-2501Z
3 Main + 1 NO Aux	50A AC1, 32A AC3	NC1-3210Z
3 Main + 1 NC Aux	50A AC1, 32A AC3	NC1-3201Z
3 Main + 1 NO + 1 NC Auxs	60A AC1, 40A AC3	NC1-4011Z
3 Main + 1 NO + 1 NC Auxs	80A AC1, 50A AC3	NC1-5011Z
3 Main + 1 NO + 1 NC Auxs	80A AC1, 65A AC3	NC1-6511Z
3 Main + 1 NO + 1 NC Auxs	95A AC1, 80A AC3	NC1-8011Z
3 Main + 1 NO + 1 NC Auxs	95A AC1, 95A AC3	NC1-9511Z

## Power Factor Correction Contactors

CE



CJ19

### POWER FACTOR CORRECTION CONTACTORS

DESCRIPTION	A	KVAR @ 230V @415V		PART NO.
3 Main + 1 NO + 1 NC Aux	17A	6	12	CJ19-2511
3 Main + 1 NO + 1 NC Aux	23A	9	18	CJ19-3211
3 Main + 1 NO + 1 NC Aux	29A	10	20	CJ19-4311
3 Main + 1 NO + 1 NC Aux	43A	15	30	CJ19-6311
3 Main + 1 NO + 1 NC Aux	63A	22	40	CJ19-9511

# Thermal Overload Relays

CE



NR2-11.5



NR2-25



NR2-36



NR2-93

## THERMAL OVERLOAD RELAYS FOR NC6 SERIES

DESCRIPTION	PART NO.
0.10A - 0.16A	NR2-11.5/0.16
0.16A - 0.25A	NR2-11.5/0.25
0.25A - 0.40A	NR2-11.5/0.40
0.40A - 0.63A	NR2-11.5/0.63
0.63A - 1.00A	NR2-11.5/1.00
1.00A - 1.60A	NR2-11.5/1.60
1.25A - 2.00A	NR2-11.5/2.00
1.60A - 2.50A	NR2-11.5/2.50
2.50A - 4.00A	NR2-11.5/4.00
4.00A - 6.00A	NR2-11.5/6.00
5.50A - 8.00A	NR2-11.5/8.00
9.00A - 13.00A	NR2-11.5/13.00

## THERMAL OVERLOAD RELAYS FOR NC1 SERIES

DESCRIPTION	FRAME SIZE	PART NO.
0.10A - 0.16A	NR2-25	NR2-0.16
0.16A - 0.25A	NR2-25	NR2-0.25
0.25A - 0.40A	NR2-25	NR2-0.40
0.50A - 0.63A	NR2-25	NR2-0.63
0.63A - 1.00A	NR2-25	NR2-1.00
1.00A - 1.60A	NR2-25	NR2-1.60
1.25A - 2.00A	NR2-25	NR2-2.00
1.60A - 2.50A	NR2-25	NR2-2.50
2.50A - 4.00A	NR2-25	NR2-4.00
4.00A - 6.00A	NR2-25	NR2-6.00
5.50A - 8.00A	NR2-25	NR2-8.00
7.00A - 10.00A	NR2-25	NR2-10.00
9.00A - 13.00A	NR2-25	NR2-13.00
12.00A - 18.00A	NR2-25	NR2-18.00
17.00A - 25.00A	NR2-25	NR2-25.00
25.00A - 32.00A	NR2-36	NR2-32.00
28.00A - 36.00A	NR2-36	NR2-36.00
30.00A - 40.00A	NR2-93	NR2-40.00
37.00A - 50.00A	NR2-93	NR2-50.00
48.00A - 65.00A	NR2-93	NR2-65.00
55.00A - 70.00A	NR2-93	NR2-70.00
63.00A - 80.00A	NR2-93	NR2-80.00
80.00A - 93.00A	NR2-93	NR2-93.00

## Contactor Accessories

CE



NR2-630



NR2-D



NC1-F5

### THERMAL OVERLOAD RELAYS FOR NC2 SERIES

DESCRIPTION	PART NO.
80A - 125A	NR2-200G-125
100A - 160A	NR2-200G-160
125A - 200A	NR2-200G-200
160A - 250A	NR2-630G-250
200A - 315A	NR2-630G-315
250A - 400A	NR2-630G-400
315A - 500A	NR2-630G-500
400A - 630A	NR2-630G-630

### OVERLOAD MOUNTING BRACKETS

DESCRIPTION	PART NO.
To Fit NR2-11.5	NR2-D03
To Fit NR2-25, 0.10A - 25.00A	NR2-D13
To Fit NR2-36, 32.00A - 36.00A	NR2-D23
To Fit NR2-93, 40.00A - 93.00A	NR2-D33

### PNEUMATIC TIMERS

DESCRIPTION	PART NO.
0.1s - 30s ON Delay	NC1-F5-T2
10s - 180s ON Delay	NC1-F5-T4
0.1s - 30s OFF Delay	NC1-F5-D2
10s - 180s OFF Delay	NC1-F5-D4

### MECHANICAL INTERLOCKS

DESCRIPTION	PART NO.
To Fit NC1-09 to NC1-32, 3P/4P	NC1M09-32
To Fit NC1-40 to NC1-65, 3P/4P	NC1M40-65
To Fit NC1-80 to NC1-95, 3P	NC1M80-95
To Fit NC1-80 to NC1-95, 4P	NC1M80-95-4P
To Fit NC2-115 to NC2-150	NC2IL-01
To Fit NC2-185 to NC2-225	NC2IL-02
To Fit NC2-265 to NC2-500	NC2IL-03
To Fit NC2-630	NC2IL-04

## Contactor Accessories

CE



NC1-32SC



NC2-FL



NCF6-22



NC1-F402



NC1-F440

### AC SPARE COILS FOR NC1 & NC2 \*SPECIFY VOLTAGE\*

DESCRIPTION	PART NO.
Coils for NC1-09 - NC1-18	NC1-12SC*
Coils for NC1-25 - NC1-32	NC1-32SC*
Coils for NC1-40 - NC1-65	NC1-40SC*
Coils for NC1-80 - NC1-95	NC1-80SC*
Coils for NC2-115 - NC2-150	NC2-FF*
Coils for NC2-185 - NC2-225	NC2-FG*
Coils for NC2-265	NC2-FH*
Coils for NC2-330	NC2-FI*
Coils for NC2-400	NC2-FJ*
Coils for NC2-500	NC2-FK*
Coils for NC2-600	NC2-FL*

### NC6 HEAD MOUNT AUXILIARY CONTACT BLOCKS

DESCRIPTION	PART NO.
2 NC Aux Block	NCF6-02
2 NO Aux Block	NCF6-20
1 NO + 1 NC Aux Block	NCF6-11
4 NC Aux Block	NCF6-04
4 NO Aux Block	NCF6-40
1 NO + 3 NC Aux Block	NCF6-13
3 NO + 1 NC Aux Block	NCF6-31
2 NO + 2 NC Aux Blocks	NCF6-22

### NC1 & NC2 HEAD MOUNT AUXILIARY CONTACT BLOCKS

DESCRIPTION	PART NO.
2 NC Aux Block	NC1-F402
2 NO Aux Blocks	NC1-F420
1 NO + 1 NC Aux Blocks	NC1-F411
2 NO + 2 NC Aux Blocks	NC1-F422
4 NC Aux Blocks	NC1-F404
4 NO Aux Blocks	NC1-F440
1 NO + 3 NC Aux Blocks	NC1-F413
2 NO + 2 NC Aux Blocks	NC1-F431

## Contactor Accessories

CE



NC2-TC



NCF1-11C

### TERMINAL COVER FOR NC2

DESCRIPTION	PART NO.
Terminal Cover to fit NC2-115	NC2-115-TC
Terminal Cover to fit NC2-150 to NC2-185	NC2-185-TC
Terminal Cover to fit NC2-225 to NC2-500	NC2-500-TC
Terminal Cover to fit NC2-630	NC2-630-TC

### NC1 AUXILIARY CONTACT BLOCK

DESCRIPTION	PART NO.
1 NO + 1 NC Side Mount Aux	NCF1-11C

### DC SPARE COILS FOR NC1 \*SPECIFY VOLTAGE\*

DESCRIPTION	PART NO.
DC Coil for NC1-09Z - 18Z	NC1-12SC-Z
DC Coil for NC1-25Z - 32Z	NC1-32SC-Z
DC Coil for NC1-40Z - 95Z	NC1-40SC-Z

## Direct On Line Starters

CE



NQ3

- Metal base
- Plastic cover
- IP55

### IP55 DIRECT ON LINE STARTERS

DESCRIPTION	PART NO.
5.5KW Starter – 110V Coil	NQ3-5.5/110
5.5KW Starter – 230V Coil	NQ3-5.5/230
5.5KW Starter – 415V Coil	NQ3-5.5/415
11KW Starter – 110V Coil	NQ3-11P/110
11KW Starter – 230V Coil	NQ3-11P/230
11KW Starter – 415V Coil	NQ3-11P/415

# Manual Motor Starters

CE



NS2-25



NS2 IP65 Enclosure



NS2 -25-MC01

## MANUAL MOTOR STARTERS

DESCRIPTION	PART NO.
0.10 - 0.16A	NS2-25-0.16
0.16A - 0.25A	NS2-25-0.25
0.25A - 0.40A	NS2-25-0.40
0.50A - 0.63A	NS2-25-0.63
0.63A - 1.00A	NS2-25-1.00
1.00A - 1.60A	NS2-25-1.60
1.60A - 2.50A	NS2-25-2.50
2.50A - 4.00A	NS2-25-4.00
4.00A - 6.30A	NS2-25-6.30
6.30A - 10.00A	NS2-25-10
9.00A - 14.00A	NS2-25-14
12.00A - 18.00A	NS2-25-18
17.00A - 23.00A	NS2-25-23
20.00A - 25.00A	NS2-25-25
25.00A - 40.00A	NS2-80B-40
40.00A - 63.00A	NS2-80B-63
56.00A - 80.00A	NS2-80B-80
IP65 Enclosure for NS2-25	NS2-25-MC
IP65 Enclosure with Emergency	NS2-25-MC01
Push Button for NS2-25	

## MANUAL MOTOR STARTER ACCESSORIES

DESCRIPTION	PART NO.
1 NO + 1 NC Head Mount Aux	NS2-25-AE11
2 NO Head Mount Aux	NS2-25-AE20
1 NO + 1 NC Side Mount Aux	NS2-25-AU11
2 NO Side Mount Auxs	NS2-25-AE20
1 NC + 1 NC Fault/Signal	NS2-25-FA0101
1 NC + 1 NO Fault/Signal	NS2-25-FA0110
1 NO + 1 NC Fault/Signal	NS2-25-FA1001
1 NO + 1 NO Fault/Signal	NS2-25-FA1010
110V Shunt Trip	NS2-25-SH110
230V Shunt Trip	NS2-25-SH220
110V Under Voltage Release	NS2-25-UV110
230V Under Voltage Release	NS2-25-UV220
400V Under Voltage Release	NS2-25-UV400
1 NO + 1 NC Head Mount Aux	NS2-80B-AU11
2 NO Head Mount Aux	NS2-80B-AU20

## 22.5mm Control Components



NP2-BA/G



NP2-BP/R



NP2-BW334



NP2-BV/R



ND16



ND16-22D



NP2LED

DESCRIPTION	PART NO.
<b>PUSH BUTTON OPERATOR WITH GUARD RING</b>	
○ White	NP2-BA/W
● Green	NP2-BA/G
● Red	NP2-BA/R
● Yellow	NP2-BA/Y
● Blue	NP2-BA/BL
● Black	NP2-BA/B
<b>PUSH BUTTON OPERATOR WITH BOOT</b>	
● Green	NP2-BP/G
● Red	NP2-BP/R
● Yellow	NP2-BP/Y
● Blue	NP2-BP/BL
● Black	NP2-BP/B
<b>ILLUMINATED PUSH BUTTON OPERATOR</b>	
○ White	NP2-BW314
● Green	NP2-BW334
● Red	NP2-BW344
● Yellow	NP2-BW354
● Blue	NP2-BW364
○ Clear	NP2-BW374
<b>INDICATOR LAMP HEADS</b>	
● Green	NP2-BV/G
● Red	NP2-BV/R
● Yellow	NP2-BV/Y
● Blue	NP2-BV/B
○ Clear	NP2-BV/C
<b>22.5mm MULTI CHIP LED INDICATORS (30K Hours Life) *SPECIFY VOLTAGE &amp; COLOUR*</b>	
● Red ● Yellow ● Green ● Amber	ND16*
24V AC/DC, 110V/230V AC only	
○ White ● Blue	ND16*
24V AC/DC	
○ White ● Blue	ND16*
110V/230V AC only	
● Red ● Yellow ● Green	ND16-22D*
110V AC/DC, 230V AC/DC	
○ White ● Blue	ND16-22D*
110V AC/DC, 230V AC/DC	
<b>BA9 FITTING LEDs *SPECIFY VOLTAGE &amp; COLOUR*</b>	
○ White ● Blue, 6V, 24V, 110V	NP2LED*
● Red ● Yellow ● Green, 6V, 24V, 110V, 230V	NP2LED*



## 22.5mm Control Components



NFM1-22



NP2-BS



NP2-BJ



NP2-ED



NP2-BG



NP2-BL832



NP2-EA

DESCRIPTION	PART NO.
<b>BUZZER *SPECIFY VOLTAGE &amp; COLOUR*</b>	
● Red ● Black, AC/DC 24~110V, AC 230, 400V. Interrupted Type	NFM1-22/F
● Red ● Black, AC/DC 24~110V, AC 230, 400V. Flush Mount Flash	NFM1-22/FS
● Red ● Black, AC/DC 24~110V, AC 230, 400V.	NFM1-22/L
<b>Continuous Flash Type</b>	
● Red ● Black, AC/DC 24~110V, AC 230, 400V.	NFM1-22/LC
<b>Continuous Lit Type</b>	
<b>SWITCH OPERATORS</b>	
40mm Twist Release Emergency Stop Operator	NP2-BS
40mm Twist Release Plastic Emergency Stop Operator	NP2-ES
40mm Spring Return Emergency Stop Operator	NP2-BC/R
2 Position (Maintained) Selector Switch Operator	NP2-BD2
3 Position (Maintained) Selector Switch Operator	NP2-BD3
2 Position (Spring Return) Selector Switch Operator	NP2-BD4
3 Position (Spring Return) Selector Switch Operator	NP2-BD5
2 Position (Maintained Wing Lever) Selector Switch Operator	NP2-BJ2
3 Position (Maintained Wing Lever) Selector Switch Operator	NP2-BJ3
2 Position (Spring Return Wing Lever) Selector Switch Operator	NP2-BJ4
3 Position (Wing Lever) Selector Switch Operator (Spring Ret. to Centre)	NP2-BJ5
2 Position (Maintained) Plastic Selector Switch Operator	NP2-ED2
<b>KEY SWITCHES</b>	
2 Position (Maintained) Key Switch, Key out in 1 position only	NP2-BG2
3 Position (Maintained) Key Switch, Key out in CENTRE position only	NP2-BG3
2 Position (Spring Return) Key Switch	NP2-BG4
3 Position (Spring Return) Key Switch, Key out CENTRE position only	NP2-BG5
2 Position (Maintained) Key Switch, Key out in BOTH positions	NP2-BG2B
3 Position (Maintained) Key Switch, Key out in LEFT position only	NP2-BG3B
3 Position (Maintained) Key Switch, Key out in RIGHT position only	NP2-BG3C
3 Position (Maintained) Key Switch, Key out in ALL positions	NP2-BG3D
3 Position (Maintained) Key Switch, Key out in LEFT & RIGHT positions	NP2-BG3E
<b>PUSH BUTTONS OPERATORS</b>	
●/● Red/Green Twin Push Button Operator	NP2-BL832
●/● Red/Green Illuminated Twin Push Button Operator	NP2-BW844
● Black Push Button Operator	NP2-EA/B
● Blue Push Button Operator	NP2-EA/BL
○ White Push Button Operator	NP2-EA/W
● Yellow Push Button Operator	NP2-EA/Y
● Black Push Button Operator with White Arrow	NP2-EA/B/A
○ White Push Button Operator with Black Arrow	NP2-EA/W/A
● Green Push Button Operator with White I	NP2-EA/G/I
● Red Push Button Operator with White 0	NP2-EA/R/O

## 22.5mm Control Components



NP2-B



NP2-BE101

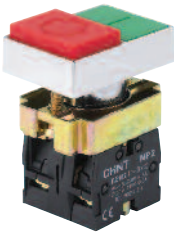

NP2-BL832, NP2-B & NP2-BE102



NP2-B324

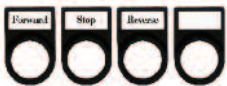

NP2-BZ31

DESCRIPTION	PART NO.
<b>MOUNTING BLOCKS &amp; CONTACT UNITS</b>	
Contacts Mounting Block	NP2-B
NO Contact Unit	NP2-BE101
NC Contact Unit	NP2-BE102
NO Contact Unit and Mounting Block	NP2-BZ101
NC Contact Unit and Mounting Block	NP2-BZ102
2 NO Contact Unit and Mounting Block	NP2-BZ103
NO Contact Block for Chint Enclosures	NP2-L1111
NC Contact Block for Chint Enclosures	NP2-L1121
<b>BUTTON BASES</b>	
Direct Feed Push Button Base	NP2-BW06
110/230V Resistor Type Push Button Base	NP2-BW07
230/6V Transformer Type Push Button Base	NP2-BW04
110/6V Transformer Type Push Button Base	NP2-BW02
<b>ENCLOSED SWITCHES &amp; UNITS</b>	
1 NC Enclosed Emergency Stop Unit	NP2-J174
Enclosed 2 Position Selector Switch with 1 NO Contact	NP2-B132
<b>PUSH BUTTON STATIONS &amp; PUSH BUTTON ENCLOSURES</b>	
2 Position Push Button Station: ●/● Red/Green	NP2-B213
3 Position Push Button Station: Up, Down & Stop	NP2-B324
2 NO + 1 NC Contacts	
1 Position Empty Push Button Enclosure	NP2-B1
2 Position Empty Push Button Enclosure	NP2-B2
3 Position Empty Push Button Enclosure	NP2-B3
<b>ACCESSORIES</b>	
Legend Plates	NP2-BZ31

## NP8 Series, Control Components



NP8-BN/3



NP8-BND/4



NP8-CB10



NP8-LED-G-110V-230V



NP8-ZS/14



NP8-S



NP8-XD/213

DESCRIPTION	PART NO.
<b>MOMENTARY FLUSH HEAD - NON ILLUMINATED</b>	
○ White	NP8-BN/1
● Green	NP8-BN/3
● Red	NP8-BN/4
● Yellow	NP8-BN/5
● Blue	NP8-BN/6
<b>MOMENTARY FLUSH HEAD - ILLUMINATED</b>	
○ White	NP8-BND/1
● Green	NP8-BND/3
● Red	NP8-BND/4
● Yellow	NP8-BND/5
● Blue	NP8-BND/6
<b>CONTACT BLOCK</b>	
N/C Contact Block	NP8-CB01
N/O Contact Block	NP8-CB10
<b>LEDs</b>	
● Green LED, AC 110V-230V	NP8-LED-G-110V-230V
● Green LED, AC/DC 24V	NP8-LED-G-24VACDC
● Red LED, AC 110V-230V	NP8-LED-R-110V-230V
● Red LED, AC/DC 24V	NP8-LED-R-24VACDC
● Yellow LED, AC 110V-230V	NP8-LED-Y-110V-230V
● Yellow LED, AC/DC 24V	NP8-LED-Y-24VACDC
● Blue LED, AC 110V-230V	NP8-LED-BL-110V-230V
● Blue LED, AC/DC 24V	NP8-LED-BL-24VACDC
<b>MUSHROOM HEAD BUTTONS &amp; SELECTOR SWITCHES</b>	
● Red 40mm Mushroom Head – Non Illuminated	NP8-M/14
● Red 40mm Mushroom Head Maintained – Non Illuminated	NP8-ZS/14
<b>DOUBLE-HEADED FLUSH MOMENTARY BUTTONS</b>	
Double-headed Flush Momentary Button – Non Illuminated	NP8-S
Double-headed Flush Momentary Button – Illuminated	NP8-SD
<b>SELECTOR SWITCHES – NON ILLUMINATED</b>	
● Black Selector Switches 2 Positions Head – Non Illuminated	NP8-X/212
● Black Selector Switches 3 Positions Head – Non Illuminated	NP8-X/312
<b>SELECTOR SWITCHES 2 POSITIONS HEAD – ILLUMINATED</b>	
○ White	NP8-XD/211
● Green	NP8-XD/213
● Red	NP8-XD/214
● Yellow	NP8-XD/215
● Blue	NP8-XD/216

## NP8 Series, Control Components



NP8-XD/313



NP8-Y/21

DESCRIPTION	PART NO.
<b>SELECTOR SWITCHES 3 POSITIONS HEAD – ILLUMINATED</b>	
○ White	NP8-XD/311
● Green	NP8-XD/313
● Red	NP8-XD/314
● Yellow	NP8-XD/315
● Blue	NP8-XD/316
<b>SELECTOR SWITCHES WITH KEY 2 POSITIONS HEAD – NON ILLUMINATED</b>	
2 Position (Maintained) Selector Switch Head	NP8-Y/21
2 Position (Spring Return) Selector Switch Head	NP8-Y/22
<b>SELECTOR SWITCHES WITH KEY 3 POSITIONS HEAD – NON ILLUMINATED</b>	
3 Position (Maintained) Selector Switch Head	NP8-Y/31

## ND9 Series, Modular Indicators



ND9

DESCRIPTION	PART NO.
<b>NP9 SERIES PUSH BUTTONS</b>	
○ White, 230V	ND9-W230
● Green, 230V	ND9-G230
● Red, 230V	ND9-R230
● Yellow, 230V	ND9-Y230
● Blue, 230V	ND9-B230
● Green + Green, 230V	ND9-GG230

## NP9 Series, Push Buttons



NP9

DESCRIPTION	PART NO.
<b>NP9 SERIES PUSH BUTTONS</b>	
● Red 230V, 2 NO and 1 NC Illuminated Push Button	NP9-153021
● Green 230V, 2 NO and 1 NC Illuminated Push Button	NP9-153024



# POWER PROTECTION DEVICES

## NM8 Moulded Case Circuit Breaker Overview

- KEMA approved
- Standard IEC/EN 60947-2
- 50KA minimum breaking capacity (Icu)
- Modular frame sizes: 250A, 630A and 1250A
- Economic 125A frame 50KA (Icu)
- Common accessories
- DC ratings for thermal magnetic protection relays
- Zero arcing
- Rotating double break contacts
- Current limiting
- Cascading and discrimination data tables
- Isolation function
- Intelligent electronic and thermal magnetic protection relays

### Product Overview

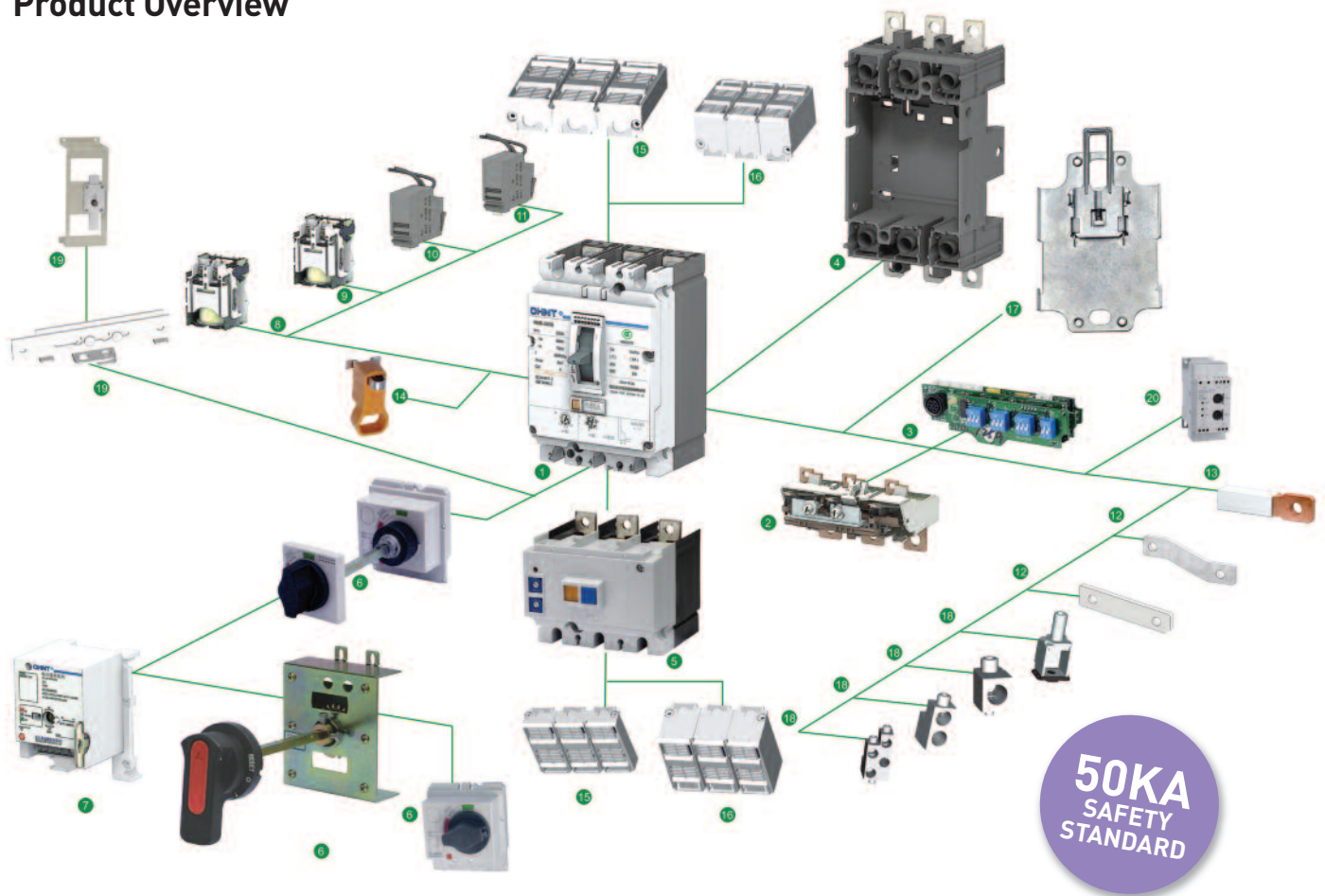

- |                                      |                             |
|--------------------------------------|-----------------------------|
| 1 Body                               | 11 Auxiliary Contact        |
| 2 Thermal-magnetic Release           | 12 Front Connection Bar     |
| 3 Electronic Release                 | 13 Rear Connection Bar      |
| 4 Plug-in Base                       | 14 Locking System (padlock) |
| 5 Residual Current Protection Module | 15 Short Terminal Cover     |
| 6 Rotary Manual Operating Handle     | 16 Extended Terminal Cover  |
| 7 Motor Driven Operating Mechanism   | 17 DIN Rail Adaptor         |
| 8 Under-voltage Release              | 18 Cage Clamp Terminal      |
| 9 Shunt Release                      | 19 Mechanical Interlock     |
| 10 Alarm Contact                     | 20 Communication Module     |

## NM8-125S Frame, Thermal Magnetic



NM8-125S-3P

NM8-125S FRAME 3 POLE ADJUSTABLE MCCB. ICU=ICS 50KA 415V			NM8-125S FRAME 4 POLE ADJUSTABLE MCCB. ICU=ICS 50KA 415V		
In (A)	li (A)	PART NO.	In (A)	li (A)	PART NO.
32	320	NM8-125S-3P-32A	32	320	NM8-125S-4P-32A
40	400	NM8-125S-3P-40A	40	400	NM8-125S-4P-40A
50	500	NM8-125S-3P-50A	50	500	NM8-125S-4P-50A
63	630	NM8-125S-3P-63A	63	630	NM8-125S-4P-63A
80	800	NM8-125S-3P-80A	80	800	NM8-125S-4P-80A
100	1000	NM8-125S-3P-100A	100	1000	NM8-125S-4P-100A
125	1250	NM8-125S-3P-125A	125	1250	NM8-125S-4P-125A

## NM8-250S Frame, Thermal Magnetic



NM8-250S-3P

NM8-250S FRAME 3 POLE ADJUSTABLE MCCB. ICU=ICS 50KA 415V			NM8-250S FRAME 4 POLE ADJUSTABLE MCCB. ICU=ICS 50KA 415V		
In (A)	li (A)	PART NO.	In (A)	li (A)	PART NO.
100	1000	NM8-250S-3P-100A	100	1000	NM8-250S-4P-100A
125	1250	NM8-250S-3P-125A	125	1250	NM8-250S-4P-125A
160	1600	NM8-250S-3P-160A	160	1600	NM8-250S-4P-160A
200	2000	NM8-250S-3P-200A	200	2000	NM8-250S-4P-200A
250	2500	NM8-250S-3P-250A	250	2500	NM8-250S-4P-250A

## NM8-400S Frame, Thermal Magnetic



NM8-400S-3P

NM8-400S FRAME 3 POLE ADJUSTABLE MCCB. ICU=ICS 50KA 415V			NM8-400S FRAME 4 POLE ADJUSTABLE MCCB. ICU=ICS 50KA 415V		
In (A)	Ii (A)	PART NO.	In (A)	Ii (A)	PART NO.
400	4000	NM8-400S-3P-400A	400	4000	NM8-400S-4P-400A

## NM8-800S Frame, Thermal Magnetic



NM8-800S-3P

NM8-800S FRAME 3 POLE ADJUSTABLE MCCB.			NM8-800S FRAME 4 POLE ADJUSTABLE MCCB.		
In (A)	Ii (A)	PART NO.	In (A)	Ii (A)	PART NO.
800	8000	NM8-800S-3P-800A	800	8000	NM8-800S-4P-800A



## NM8-1250S Frame, Thermal Magnetic



NM8-1250S-3P

NM8-1250S FRAME 3 POLE ADJUSTABLE MCCB.		
In (A)	li (A)	PART NO.
1000	10000	NM8-1250S-3P-1000A
1250	12500	NM8-1250S-3P-1250A

NM8-1250S FRAME 4 POLE ADJUSTABLE MCCB.		
In (A)	li (A)	PART NO.
1000	10000	NM8-1250S-4P-1000A
1250	12500	NM8-1250S-4P-1250A

## NM8S-400S Frame, Electronic



NM8S-400S-3P

NM8S-400S FRAME 3 POLE ADJUSTABLE MCCB. ICU=ICS 50KA 415V		
In (A)	li (A)	PART NO.
400	4000	NM8S-400S-3P-400A

NM8S-400S FRAME 4 POLE ADJUSTABLE MCCB. ICU=ICS 50KA 415V		
In (A)	li (A)	PART NO.
400	4000	NM8S-400S-4P-400A

## NM8S-630S Frame, Electronic



NM8S-630S-3P

NM8S-630S FRAME 3 POLE ADJUSTABLE MCCB. ICU=ICS 50KA 415V		
In (A)	Ii (A)	PART NO.
630	7560	NM8S-630S-3P-630A

NM8S-630S FRAME 4 POLE ADJUSTABLE MCCB. ICU=ICS 50KA 415V		
In (A)	Ii (A)	PART NO.
630	7560	NM8S-630S-4P-630A

## NM8S-800S Frame, Electronic

NM8S-800S FRAME 3 POLE ADJUSTABLE MCCB. ICU=ICS 50KA 415V		
In (A)	Ii (A)	PART NO.
800	9600	NM8S-800S-3P-800A

NM8S-800S FRAME 4 POLE ADJUSTABLE MCCB. ICU=ICS 50KA 415V		
In (A)	Ii (A)	PART NO.
800	9600	NM8S-800S-4P-800A

## NM8S-1250S Frame, Electronic

NM8S-1250S FRAME 3 POLE ADJUSTABLE MCCB.		
In (A)	Ii (A)	PART NO.
1000	12000	NM8S-1250S-3P-1000A
1250	15000	NM8S-1250S-3P-1250A

NM8S-1250S FRAME 4 POLE ADJUSTABLE MCCB.		
In (A)	Ii (A)	PART NO.
1000	12000	NM8S-1250S-4P-1000A
1250	15000	NM8S-1250S-4P-1250A

## 125A Frame Accessories

DESCRIPTION	PART NO.
<b>3P, 125A FRAME ACCESSORIES</b>	
3P Short Terminal Shield	NM8-ST-3P-125
3P Long Terminal Shield	NM8-LT-3P-125
3P/4P Rotary Handle, Metal	NM8-MR-125
3P IP55 Rotary Handle, Plastic	NM8-MR55-125
3P Boxing Contact (pack of 3)	NM8-BT-3P-125
3P Interlock Plate	NM8-IL-3P-125
3P Front Connection Bar	NM8-FCP-3P-125
3P Din Rail Adaptor	NM8-ADPT-3P-125
<b>4P, 125A FRAME ACCESSORIES</b>	
4P Short Terminal Shield	NM8-ST-4P-125
4P Long Terminal Shield	NM8-LT-4P-125
3P/4P Rotary Handle, Metal	NM8-MR-125
4P IP55 Rotary Handle, Plastic	NM8-MR55-125
4P Boxing Contact (pack of 4)	NM8-BT-4P-125
4P Interlock Plate	NM8-IL-4P-125
4P Front Connection Bar	NM8-FCP-4P-125
<b>125A FRAME ACCESSORIES</b>	
Auxiliary Contact (Inc. 1 NO + 1 NC)	NM8-AX-630
Alarm Contact (Inc. 1 NO + 1 NC)	NM8-AL-630
230V Shunt Trip	NM8-SH230-125
230V Undervoltage Release	NM8-UV230-125
Toggle Padlock Device	NM8-PL-125
Motor Operator 230V	NM8-MM230-125

## 250A Frame Accessories

DESCRIPTION	PART NO.
<b>3P, 250A FRAME ACCESSORIES</b>	
3P Short Terminal Shield	NM8-ST-3P-250
3P Long Terminal Shield	NM8-LT-3P-250
3P/4P Rotary Handle, Metal	NM8-MR-250
3P IP55 Rotary Handle, Plastic	NM8-MR55-250
3P Boxing Contact (pack of 3)	NM8-BT-3P-250
3P Interlock Plate	NM8-IL-3P-250
3P Front Connection Bar	NM8-FCP-3P-250
<b>4P, 250A FRAME ACCESSORIES</b>	
4P Short Terminal Shield	NM8-ST-4P-250
4P Long Terminal Shield	NM8-LT-4P-250
3P/4P Rotary Handle, Metal	NM8-MR-250
4P IP55 Rotary Handle, Plastic	NM8-MR55-250
4P Boxing Contact (pack of 4)	NM8-BT-4P-250
4P Interlock Plate	NM8-IL-4P-250
4P Front Connection Bar	NM8-FCP-4P-250
<b>250A FRAME ACCESSORIES</b>	
Auxiliary Contact (Inc. 1 NO + 1 NC)	NM8-AX-630
Alarm Contact (Inc. 1 NO + 1 NC)	NM8-AL-630
230V Shunt Trip	NM8-SH230-250
230V Undervoltage Release	NM8-UV230-250
Toggle Padlock Device	NM8-PL-250
Motor Operator 230V	NM8-MM230-250

## 400A & 600A Frame Accessories

DESCRIPTION	PART NO.
<b>3P, 400A &amp; 600A FRAME ACCESSORIES</b>	
3P Short Terminal Shield	NM8-ST-3P-630
3P Long Terminal Shield	NM8-LT-3P-630
3P/4P Rotary Handle, Metal	NM8-MR-630
3P IP55 Rotary Handle, Plastic	NM8-MR55-630
3P Boxing Contact (pack of 3)	NM8-BT-3P-630
3P Interlock Plate	NM8-IL-3P-630
3P Front Connection Bar	NM8-FCP-3P-630
<b>4P, 400A &amp; 600A FRAME ACCESSORIES</b>	
4P Short Terminal Shield	NM8-ST-4P-630
4P Long Terminal Shield	NM8-LT-4P-630
3P/4P Rotary Handle, Metal	NM8-MR-630
4P IP55 Rotary Handle, Plastic	NM8-MR55-630
4P Boxing Contact (pack of 4)	NM8-BT-4P-630
4P Interlock Plate	NM8-IL-4P-630
4P Front Connection Bar	NM8-FCP-4P-630
<b>400A &amp; 600A FRAME ACCESSORIES</b>	
Auxiliary Contact (Inc. 1 NO + 1 NC)	NM8-AX-630
Alarm Contact (Inc. 1 NO + 1 NC)	NM8-AL-630
230V Shunt Trip	NM8-SH230-630
230V Undervoltage Release	NM8-UV230-630
Toggle Padlock Device	NM8-PL-630
Motor Operator 230V	NM8-MM230-630

## 800A & 1250A Frame Accessories

DESCRIPTION	PART NO.
<b>3P, 800A &amp; 1250A FRAME ACCESSORIES</b>	
3P Short Terminal Shield	NM8-ST-3P-1250
3P Long Terminal Shield	NM8-LT-3P-1250
3P/4P Rotary Handle, Metal	NM8-MR-1250
3P IP55 Rotary Handle, Plastic	NM8-MR55-1250
3P Boxing Contact (pack of 3)	NM8-BT-3P-1250
3P Interlock Plate	NM8-IL-3P-1250
3P Front Connection Bar	NM8-FCP-3P-1250
<b>4P, 800A &amp; 1250A FRAME ACCESSORIES</b>	
4P Short Terminal Shield	NM8-ST-4P-1250
4P Long Terminal Shield	NM8-LT-4P-1250
3P/4P Rotary Handle, Metal	NM8-MR-1250
4P IP55 Rotary Handle, Plastic	NM8-MR55-1250
4P Boxing Contact (pack of 4)	NM8-BT-4P-1250
4P Interlock Plate	NM8-IL-4P-1250
4P Front Connection Bar	NM8-FCP-4P-1250
<b>800A &amp; 1250A FRAME ACCESSORIES</b>	
Auxiliary Contact (Inc. 1 NO + 1 NC)	NM8-AX-1250
Alarm Contact (Inc. 1 NO + 1 NC)	NM8-AL-1250
230V Shunt Trip	NM8-SH230-1250
230V Undervoltage Release	NM8-UV230-1250
Toggle Padlock Device	NM8-PL-1250
Motor Operator 230V	NM8-MM230-1250

# NM8 Thermal & Electronic Protection Relays

## Thermal-magnetic Release

- Thermal-magnetic release of NM8-250, 630 & 1250 breakers can be set to meet protection requirements
- $I_r = 1 - 0.8 \times I_n$ ,  $I_i = 10 - 5 \times I_n$

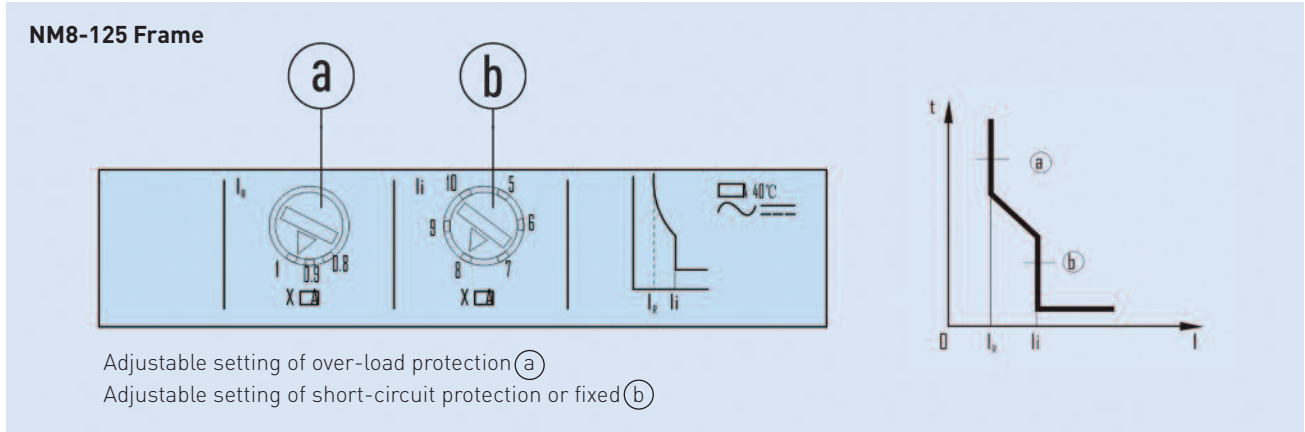

- Electronic protection relays offer very selective characteristic settings, allowing close protection of loads

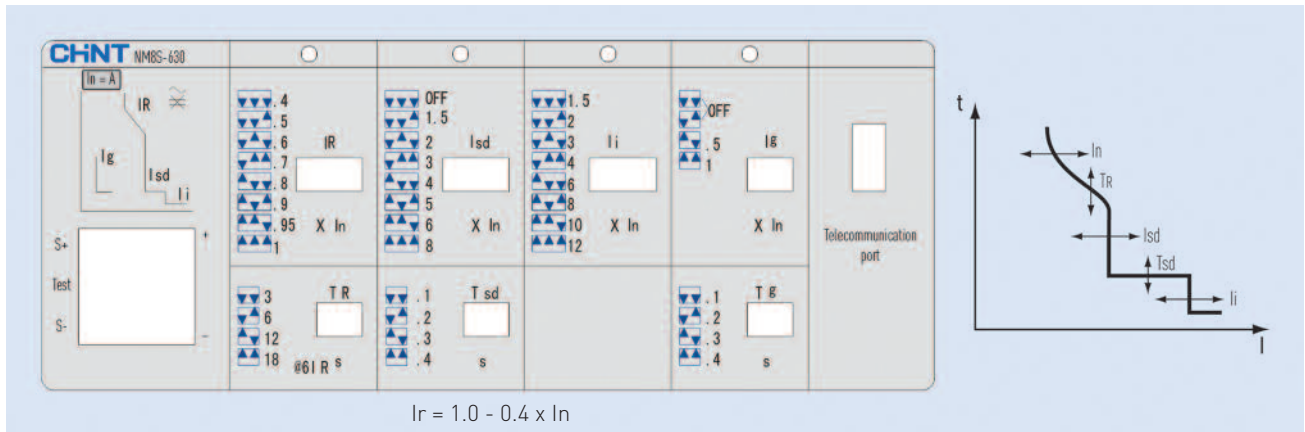

- Characteristic curve. NM8S-400, 630 (250A~630A)

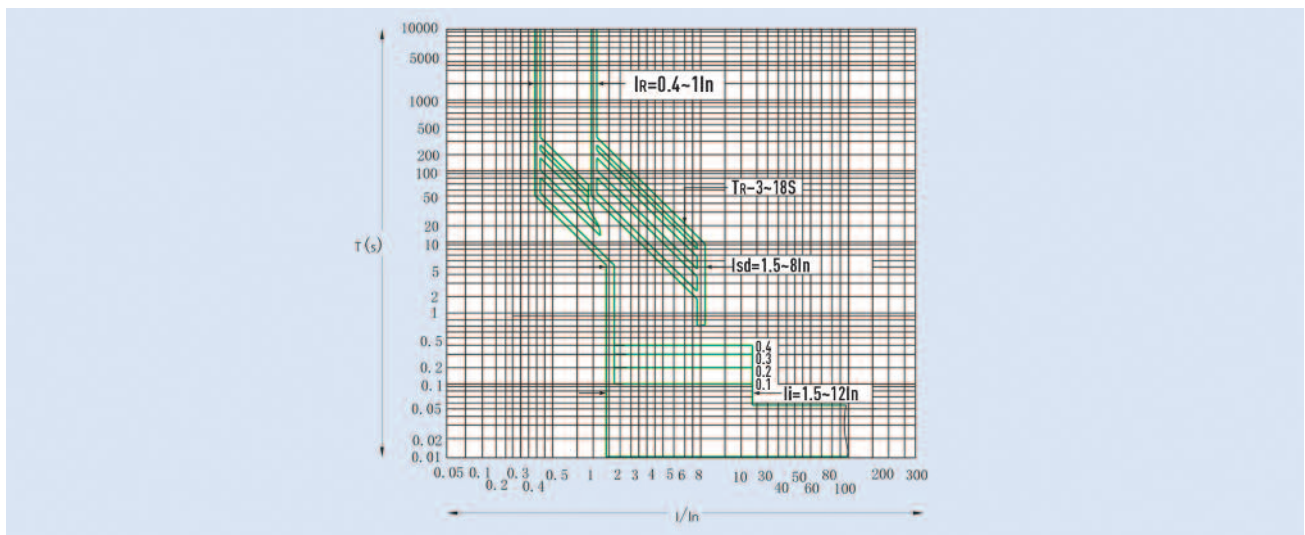

## NM8 Dimensions

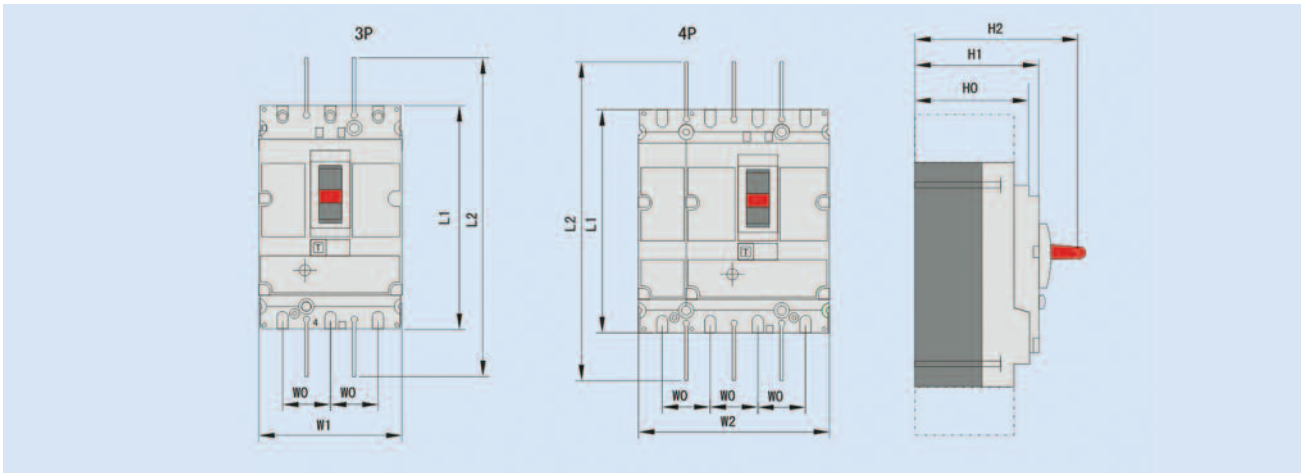

### NM8 DIMENSIONS

PART NUMBER	W0	W1	W2	L1	L2	H0	H1	H2
NM8-125S	30	90	120	140	240	72	79	103
NM8-250S	35	105	140	157	357	82	88	126
NM8-400/630	45	140	185	255	474	95	113	168
NM8-800/1250	70	210	280	370	570	132	144	206

NM8	NM8-125	NM8S-125 NM8-250 NM8S-250	NM8-400, 630 NM8S-400,600	NM8-800, 1250 NM8S-800, 1250
Distance between different poles (W0)	30	35	45	70
L	≤15	≤25	≤32	≤45
D	≤7	≤10	≤16	≤16
φ	>6	>8	>10	>11

All dimensions in millimetres.

## NM8L SERIES, ELCB MCCB



NM8L-125

- Combined ELCB
- MCCB and RCD unit are both adjustable
- Power indication
- Easily judge the reason of the fault
- High breaking capacity to 50KA
- Arcing free

NM8L-125S ELCB MCCB, 3 Pole	
DESCRIPTION	PART NO.
20A 3P MCCB inc. RCD Adjustable	NM8L-125S-3P-20A-X1-T1
32A 3P MCCB inc. RCD Adjustable	NM8L-125S-3P-32A-X1-T1
50A 3P MCCB inc. RCD Adjustable	NM8L-125S-3P-50A-X1-T1
63A 3P MCCB inc. RCD Adjustable	NM8L-125S-3P-63A-X1-T1
100A 3P MCCB inc. RCD Adjustable	NM8L-125S-3P-100A-X1-T1
125A 3P MCCB inc. RCD Adjustable	NM8L-125S-3P-125A-X1-T1

NM8L-125S ELCB MCCB, 4 Pole	
DESCRIPTION	PART NO.
20A 4P MCCB inc. RCD Adjustable	NM8L-125S-4P-20A-X1-T1
32A 4P MCCB inc. RCD Adjustable	NM8L-125S-4P-32A-X1-T1
50A 4P MCCB inc. RCD Adjustable	NM8L-125S-4P-50A-X1-T1
63A 4P MCCB inc. RCD Adjustable	NM8L-125S-4P-63A-X1-T1
100A 4P MCCB inc. RCD Adjustable	NM8L-125S-4P-100A-X1-T1
125A 4P MCCB inc. RCD Adjustable	NM8L-125S-4P-125A-X1-T1
63A 4P MCCB inc. RCD Adjustable	NM8L-125S-4P-63A-X2-T1
100A 4P MCCB inc. RCD Adjustable	NM8L-125S-4P-100A-X2-T1

NM8L-250S ELCB MCCB, 3 Pole	
DESCRIPTION	PART NO.
20A 3P MCCB inc. RCD Adjustable	NM8L-250S-3P-20A-X1-T1
32A 3P MCCB inc. RCD Adjustable	NM8L-250S-3P-32A-X1-T1
50A 3P MCCB inc. RCD Adjustable	NM8L-250S-3P-50A-X1-T1
63A 3P MCCB inc. RCD Adjustable	NM8L-250S-3P-63A-X1-T1
100A 3P MCCB inc. RCD Adjustable	NM8L-250S-3P-100A-X1-T1
125A 3P MCCB inc. RCD Adjustable	NM8L-250S-3P-125A-X1-T1

NM8L-250S ELCB MCCB, 4 Pole	
DESCRIPTION	PART NO.
20A 4P MCCB inc. RCD Adjustable	NM8L-250S-4P-20A-X1-T1
32A 4P MCCB inc. RCD Adjustable	NM8L-250S-4P-32A-X1-T1
50A 4P MCCB inc. RCD Adjustable	NM8L-250S-4P-50A-X1-T1
63A 4P MCCB inc. RCD Adjustable	NM8L-250S-4P-63A-X1-T1
100A 4P MCCB inc. RCD Adjustable	NM8L-250S-4P-100A-X1-T1
125A 4P MCCB inc. RCD Adjustable	NM8L-250S-4P-125A-X1-T1
63A 4P MCCB inc. RCD Adjustable	NM8L-250S-4P-63A-X2-T1
100A 4P MCCB inc. RCD Adjustable	NM8L-250S-4P-100A-X2-T1

TYPE	RATED RESIDUAL OPERATING CURRENT I <sub>Δn</sub> (A)	BREAKING TIME OF RESIDUAL CURRENT t(s)
NM8L-125S	X1: 0.05-0.1-0.2-0.5	t1: 0.1-0.3-0.5-1
NM8L-250S	X2: 0.1-0.3-0.5-1	t2: 0.2-0.5-1-2
NM8L-400S	X3: 0.3-0.5-1-2	t3: 0.2-1-2-3
NM8L-630S	X3: 0.2-0.5-1-2	

Note: I<sub>Δn0</sub>=50% I<sub>Δn</sub>. X1, X2, X3, X4 can be combined with t1, t2 and t3 at will.

## NZ7 Series, Automatic Transfer Switch



NZ7

- Circuit protection combined MCCB type automatic transfer switch
- Dual-power Supply automatic transfer
- Dual-interlock protection
- Digital Controller with multi display
- Multipurpose functions
- Energy saving

### NZ7 AUTOMATIC TRANSFER SWITCH

DESCRIPTION	PART NO.
63A, 3 Pole	NZ7-63H/3/63
63A, 4 Pole	NZ7-63H/4/63
80A, 3 Pole	NZ7-125H/3/80
100A, 3 Pole	NZ7-125H/3/100
80A, 4 Pole	NZ7-125H/4/80
100A, 4 Pole	NZ7-125H/4/100
160A, 3 Pole	NZ7-250H/3/160
200A, 3 Pole	NZ7-250H/3/200
225A, 3 Pole	NZ7-250H/3/225
160A, 4 Pole	NZ7-250H/4/160
200A, 4 Pole	NZ7-250H/4/200
225A, 4 Pole	NZ7-250H/4/225
250A, 3 Pole	NZ7-400H/3/250
315A, 3 Pole	NZ7-400H/3/315
350A, 3 Pole	NZ7-400H/3/350
400A, 3 Pole	NZ7-400H/3/400
250A, 4 Pole	NZ7-400H/4/250
315A, 4 Pole	NZ7-400H/4/315
350A, 4 Pole	NZ7-400H/4/350
400A, 4 Pole	NZ7-400H/4/400
500A, 3 Pole	NZ7-630H/3/500
630A, 3 Pole	NZ7-630H/3/630
500A, 4 Pole	NZ7-630H/4/500
630A, 4 Pole	NZ7-630H/4/630



## MCCB Type Isolator



NH18

### MCCB TYPE ISOLATOR

DESCRIPTION	PART NO.
250A, 3 Pole Isolator	NH18-250/250/3
250A, 4 Pole Isolator	NH18-250/250/4
400A, 3 Pole Isolator	NH18-400/400/3
400A, 4 Pole Isolator	NH18-400/400/4

## Switch Disconnecter

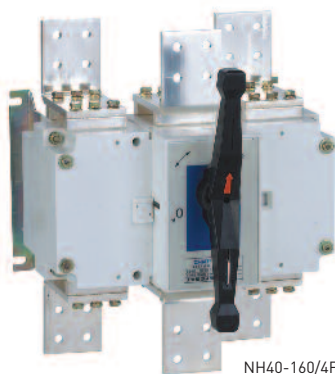

NH40-160/4F

### SWITCH DISCONNECTOR

DESCRIPTION	PART NO.
160A Switch Disconnecter	NH40-160/4F

## NA8G Air Circuit Breaker



Please contact Chint for further details.

## Consumer Unit & Enclosure Dimensions

PART NO.	H (mm)	W (mm)	D (mm)
<b>NXDB MARK III 3 PHASE TP&amp;N BOARD (PAGES 6-14)</b>			
NXDB-4	600	500	155
NXDB-6	700	500	155
NXDB-8	735	500	155
NXDB-12	850	500	155
NXDB-18	1000	500	155
NXDB-4G	600	500	155
NXDB-6G	700	500	155
NXDB-8G	735	500	155
NXDB-12G	850	500	155
NXDB-18G	1000	500	155
8 Way PAN Assembly	555	428	120
12 Way PAN Assembly	715	428	120
18 Way PAN Assembly	950	428	120
EX-1803/SB	400	500	155
250A 4P Incomer Unit with Cable Shrouds	400	500	155
Dual Meter Kit, Enclosure, Incomer and Cables	400	500	155
<b>NM1T ENCLOSED MCCBS, 3P (PAGE 15) * Depth includes handle</b>			
NM1T-32/3	400	300	215*
NM1T-63/3	400	300	215*
NM1T-125/3	400	300	215*
NM1T-250/3	600	400	315*
NM1T-400/3	800	600	315*
NM1T-630/3	1000	600	315*
<b>NM1T ENCLOSED MCCBS, 4P (PAGE 15) * Depth includes handle</b>			
NM1T-32/4	400	300	215*
NM1T-63/4	400	300	215*
NM1T-80/4	400	300	215*
NM1T-100/4	400	300	215*
NM1T-125/4	400	300	215*
NM1T-200/4	600	400	315*
NM1T-250/4	600	400	315*
NM1T-400/4	800	600	315*
NM1T-630/4	1000	600	315*

PART NO.	H (mm)	W (mm)	D (mm)
<b>3P &amp; 4P NM1TL ENCLOSED ELCB (PAGE 15) * Depth includes handle</b>			
NM1TL-063	500	400	215*
NM1TL-100	500	400	215*
NM1TL-160	600	400	315*
NM1TL-200	600	400	315*
NM1TL-250	600	400	315*
<b>WALL MOUNTED METAL ENCLOSURES (PAGE 16)</b>			
ENC-2520/15	250	200	150
ENC-3025/15	300	250	150
ENC-4030/15	400	300	150
ENC-5040/15	500	400	150
ENC-6040/26	600	400	260
ENC-7050/26	700	500	260
ENC-8060/26	800	600	260
<b>SINGLE PHASE METAL UNITS – SURFACE (PAGE 17)</b>			
NX2-8T	260	254	110
NX2-10T	260	290	110
NX2-12T	260	325	110
NX2-15T	260	380	110
NX2-18T	260	435	110
NX2-20T	260	470	110
<b>SINGLE PHASE METAL UNITS – FLUSH (PAGE 17)</b>			
NX2-8TF	290	284	110
NX2-10TF	290	320	110
NX2-12TF	290	355	110
NX2-15TF	290	410	110
NX2-18TF	290	465	110
NX2-20TF	290	500	110

**\*\* Please note: Cabling access points are meant as "Cut outs, NOT Knock Outs" using a drill and saw, alternatively a sharp knife such as a Stanley knife, otherwise damage to the enclosure may occur. \*\***

These products conform to IEC – EN 60439-3 and are manufactured from flame retardant materials.

## Consumer Unit & NDK Dimensions

PART NO.	H (mm)	W (mm)	D (mm)
<b>DUAL RCDS CONSUMER UNITS</b> (PAGE 18)			
NX2-14DSL-A	250	325	144
NX2-14DSL-H	250	325	144
NX2-18DSL-A	250	395	144
NX2-18DSL-H	250	395	144
<b>SPLIT LOAD CONSUMER UNITS</b> (PAGE 18)			
NX2-10W	250	255	144
NX2-14A	250	325	144
NX2-14H	250	325	144
NX2-18A	250	395	144
NX2-18H	250	395	144
<b>CONSUMER UNITS</b> (PAGE 19)			
NX2-8M	250	215	144
NX2-10M	250	255	144
NX2-14M	250	325	144
NX2-18M	250	395	144
<b>ENCLOSURES</b> (PAGE 19)			
NXW1-3	120	100	109
NXW1-5	120	135	109
NX2-10A	250	255	144
<b>PRE-ASSEMBLED ENCLOSURES</b> (PAGE 19)			
A29800	120	100	109
A28600/2	120	135	109
<b>PRE-ASSEMBLED CONSUMER UNITS</b> (PAGE 20)			
NX2-14DSL RH1	250	325	144
NX2-18DSL RH1	250	395	144

PART NO.	H (mm)	W (mm)	D (mm)
<b>28 &amp; 36 WAY INSULATED CONSUMER UNITS</b> (PAGE 20)			
NX2-28A	510	325	120
NX2-36A	510	395	120
<b>ENCLOSED ROTARY ISOLATOR</b> (PAGE 31)			
SRS-332	160	83	85
SRS-432	160	83	85
SRS-363	190	95	160
SRS-463	190	95	160
SRS-3100	250	160	190
SRS-4100	250	160	190

PART NO.	A (mm)	B (mm)	C (mm)
<b>NDK CIRCUIT TRANSFORMER</b> (PAGE 38)			
NDK-50	84	83	85
NDK-100	99	87	103
NDK-150	99	93	103
NDK-200	99	105	103
NDK-250	150	120	130
NDK-300	150	125	130
NDK-400	153	155	148
NDK-500	153	155	148
NDK-1000	174	186	173

## Helpful Information

### Definition of Degrees of Protection to IEC I44

#### IP

#### PROTECTION AGAINST SOLID OBJECTS

<b>0</b>	No Protection
<b>1</b>	Protection against solid objects up to 50mm e.g. accidental touch by hands
<b>2</b>	Protection against solid objects up to 12mm e.g. fingers
<b>3</b>	Protection against solid objects up to 2.5mm e.g. tools and wires
<b>4</b>	Protection against solid objects over 1mm e.g. tools and small wires
<b>5</b>	Protection against dust (no harmful deposit)
<b>6</b>	Totally protected against dust

#### PROTECTION AGAINST LIQUIDS

<b>0</b>	No Protection
<b>1</b>	Protected against vertically falling drops of water e.g. condensation
<b>2</b>	Protected against direct sprays of water up to 15° from the vertical
<b>3</b>	Protected against sprays to 60° from the vertical
<b>4</b>	Protected against water sprayed from all directions
<b>5</b>	Protected against low pressure jets of water from all directions
<b>6</b>	Protected against conditions on ship decks
<b>7</b>	Protected against immersion in water
<b>8</b>	Protected against long periods of immersion under pressure

### Useful Formulae

$$KVA = \frac{h.p. \times 746}{1000 \times p.f. \times \text{Efficiency}}$$

$$IL = \frac{h.p. \times 746}{VL \times 1.73 \times \text{Efficiency} \times p.f.}$$

$$KW = \frac{IL \times VL \times 1.73 \times p.f.}{1000}$$

$$h.p. = \frac{KW \times 1000 \times \text{Efficiency}}{746}$$

$$h.p. = \frac{KVA \times 1000 \times \text{Efficiency} \times p.f.}{746}$$

$$h.p. = \frac{VL \times IL \times 1.73 \times \text{Efficiency} \times p.f.}{746}$$

$$KVA = \frac{KW}{p.f.}$$

$$KVA = \frac{IL \times VL \times 1.73}{1000}$$

$$KW = KVA \times p.f.$$

Where:

VL = Line Voltage IL = Line Current and p f = Power Factor

$$\text{Power Factor} = \frac{KW \times 1000}{1.73 \times \text{Volts} \times \text{Amps}}$$

### KVA TO AMPERES (415V 3PH)

KVA	A	KVA	A
45	63	453	630
58	80	575	800
72	100	719	1000
90	125	899	1250
115	160	1150	1600
144	200	1438	2000
180	250	1797	2500
226	315	2264	3150
288	400	2875	4000
359	500		

# STANDARD TERMS AND CONDITIONS OF SALE

Unless otherwise stated in writing, the following conditions shall apply:

## 1. DEFINITIONS

“The seller” means Chint Europe (UK) Ltd.  
“The Purchaser” means the Company, firm or person to be supplied with the Goods by the Seller.  
“Goods” means the products or services to be supplied as per the Contract.  
“The Contract” means the Contract for sale/purchase of the Goods made between the Seller and the Purchaser to which these Conditions apply.

## 2. QUOTATIONS & ACCEPTANCE

- a) Quotations issued shall remain valid for a period of thirty (30) days from the date of issue unless otherwise stated and represent no obligation on the part of the Seller until the Seller accepts the Purchaser's order.
- b) The Purchaser's order or acceptance must be identified with an order number and must contain sufficient information to enable the Seller to proceed.
- c) The Seller's conditions shall prevail in the event of inconsistency between conditions of the Seller and the Purchaser. Any variation of the Seller's conditions shall only become binding on the Seller when accepted in writing by a duly authorised person on behalf of the Seller.

## 3. PRICE & DELIVERY

- a) Prices quoted do not include VAT.
- b) Carriage and delivery will be arranged at the request and at the expense of the Purchaser. Where applicable C.O.D. charges will be added to the price of the Goods.
- c) Price variation - The Seller reserves the right to increase the process of the Goods agreed to be sold in proportion to any increase of costs to the Seller between the date of acceptance of the order and the date of delivery (including but not by way of limitation those relating to exchange rates, labour, materials, transport and taxes) of where the increase is due to any act of default of the Purchaser including the cancellation by the Purchaser of part of any order.
- d) Any delivery period quoted is an estimate only and does not form part of the Contract, and the Seller shall not be held liable for failure to deliver within any quoted period.
- e) Claims for damage or shortage must be made within 5 working days from date of receipt of Goods at the Purchaser's specified delivery address. Claims for non-delivery must be made in writing within 10 working days of the invoice date.

## 4. PAYMENT

Where account facilities are not approved, payment will be made by cheque or credit card with order. Where account facilities have been approved, payment will be due 30 days after the date the Goods are invoiced, unless otherwise agreed in writing. Payment shall not be withheld on account of any unrelated claim by the Purchase against the Seller. The Seller reserves the right to suspend deliveries where payment of any invoice has not been made on the due date. The Seller reserves the right to charge interest of 2% per month on any amounts outstanding after the due date. The Seller reserves the right to cancel any Contract due to later or non-payment of account if, in the reasonable opinion of the Seller, the Purchaser is unlikely to be able or willing to pay accounts as they fall due. The value of Goods specifically ordered and held in stock against any Contract will be claimed in the event of late or non-payment of account.

## 5. DESCRIPTION

- a) The Goods will be those supplied to the manufacturer's current standard specification and finish.
- b) The Seller accepts no liability for any damage or injury arising directly or indirectly from any error or omission in the accuracy of technical data or literature relating to the Goods not being caused by the gross neglect of the Seller.

## 6. TITLE

Payment in full is due in respect of any Goods delivered. Until payment is made in full the Goods shall remain in the Property of the Seller but the risk therein and all liability to third parties in respect thereof shall pass to the Purchaser on delivery. Until full payment has been made, the Purchaser shall store the Goods in such a way as to enable them to be identified as the property of the Seller. Notwithstanding such retention of Title the Purchaser may re-sell the Goods to its own customers in the ordinary course of its business. The privilege may be withdrawn by the Seller at any time at his discretion. Title of Goods cannot pass to a third party until all invoices or outstanding amounts are paid for in full. The Purchaser shall accordingly set aside funds from any re-sale of Goods in whatever form to cover full payment of the Seller's Goods. Upon any breach of Contract, the Purchaser shall return any Goods as requested and allow the Seller immediate access to any premises where Goods are held to enable identification and re-possession as required by the Seller. No liability will be accepted by the Seller for loss or damage howsoever incurred during the exercising of the above rights of re-possession. The Purchaser shall insure the Goods from time of delivery and at all times while the Goods remain in their possession for the full invoice value of the Goods.

## 7. LIMITATION OF LIABILITY

- a) Except to the extent described in Condition 6, the Seller shall not be liable in Contract tort or otherwise for any loss, damage, injury, expense or cost suffered or incurred by the Purchaser or any third party (including but not limited to consequential or indirect loss or loss of profit) whatsoever or howsoever arising out of/in connection with the supply of Goods or Services by the Seller other than to supply Goods conforming to the original agreed specification or at the Seller's option to refund to the Purchaser any monies already paid in respect of the Goods or Services.
- b) The Seller's obligation under Condition 6 is the sole liability of the Seller in respect of the quality, fitness for purpose, compliance with description and/or their compliance with sample. All other representations, warranties, conditions, terms and statements in respect of the Goods or Services express or implied Statutory or otherwise are excluded save where not capable of exclusion by Law.

## 8. FORCE MAJEURE

The Seller shall have no liability in respect of failure to deliver or perform or delay in the delivering or performing any obligations under the Contract due to causes outside the reasonable control of the Seller such as acts of God, fire, floods, war and civil disturbances or not, acts of Government, currency restriction, labour disputes, strikes, unavailability of materials or failure of supplier or subcontractor to deliver on time.

## 9. STORAGE

When delivery is delayed for reasons attributable to the Purchaser or its Agents, storage and other additional costs will be charged to the Purchaser and the Goods will be at the Purchaser's risk from the date of commencement as such. The Seller reserves the right to invoice the Goods at the original delivery date.

## 10. PATENT RIGHTS

- a) The sale of Goods and the publication of any information or technical data relating thereto does not imply freedom from patent registered design or other industrial property rights in respect of any particular application of the Goods.
- b) The Purchaser warrants that the designs and specifications supplied by it to the Seller will not involve the infringement of any patent registered design or other industrial property right in the manufacture and sale of the Goods by the Seller.
- c) The Purchaser undertakes to indemnify and keep indemnified the Seller against all royalties, claims, actions, demands, proceedings, losses and costs in connection with any infringement or alleged infringement of any patent, registered design or other industrial property right in the manufacture sale or application of the Goods, arising out of or in connection with the matters described in paragraphs a) and b) above provided that nothing in the Clause shall operate to the prejudice of the Statutory undertakings as to title, etc. contained in Section 12 Sale of Goods Act 1893 as amended.

## 11. PURCHASER'S SAMPLES & DRAWINGS

Drawings and samples supplied by the Purchaser for the Contract shall be suitable quality and shall be provided free of charge in sufficient quantities and at the times required by the Seller. Any delay in such drawings and samples provided by the Purchaser shall not entitle the Purchaser to rescind the Contract, reject the Goods, make deductions from the Contract price or claim damages in respect of such defect and the Purchaser shall indemnify and keep indemnified the Seller from and against all actions, demands, claims, proceedings, losses of costs arising from the supply of defective drawings and samplers by the Purchaser.

## 12. ORIGIN OF GOODS

The Seller makes no representation and gives no warranty in respect of the sources of origin of manufacture or production of the Goods or any part thereof.

## 13. DOCUMENTS

The Seller will supply one invoice and one Advice Note for each consignment of Goods, notwithstanding that the consignment may compose more than one package.

## 14. CANCELLATION AND RETURN OF GOODS

- a) Cancellation will not be accepted for non-stock items. If the Seller agrees to accept cancellation of an order for stock items, a minimum charge of 20% of the total order price may be made.
- b) No returns are permitted without the Seller's previous consent.
- c) If the Seller agrees to accept returns they may be returned at the Purchasers expense in the condition in which they were supplied to a minimum charge of 20% of the total order price.

## 15. LAW

Any question of law relating to these Conditions or agreed amendments thereof or the terms of any Contract between the Purchaser and the Seller shall be determined in all respects by the Laws of England.

UK Registered Company No. 5058286

Adequate Main and Earth connections are provided, it is the installer's responsibility to ensure these are adequately tightened when the system is being commissioned.

PLEASE NOTE: Carriage is charged extra on NXDB Boards.

# CHINT

**Chint Europe (UK) Ltd**  
Bracken Trade Park,  
Dumers Lane,  
Bury BL9 9QP

**Tel: +44 (0) 161 762 9333**  
**Fax: +44 (0) 161 762 9898**  
**E-mail: [sales@chint.co.uk](mailto:sales@chint.co.uk)**  
**[www.chint.co.uk](http://www.chint.co.uk)**

© CHINT Group All Rights Reserved

Chint possess many 3rd party product approvals.  
Detailed information is complex. Full information on  
approvals and applicable specifications can be obtained  
from [www.chint.com](http://www.chint.com)

Specifications and technical data are subject to change  
without notice. Please contact us to confirm relevant  
information on ordering.

PLBR03.14/001

**SHIELD SOLUTIONS**