



Kraus & Naimer

BLUE LINE switchgear

since 1907

Catalog 302

12/2015

Push Buttons and Pilot Lights, Ø 22,5 mm



Kraus & Naimer

The development of the Blue Line rotary switch, contactor and motor starter product ranges is based on more than seventy-five years experience by Kraus & Naimer in the design and manufacture of electrical switchgear. Kraus & Naimer pioneered the introduction of the cam operated rotary switch and continues to be recognized as the world leader in that product field.

BLUE LINE

Blue Line products are protected by numerous patents throughout the industrial world. They are built to national and international standards and designed to withstand adverse temperatures and climates.

Blue Line products are accepted and universally recognized for their quality and workmanship. They are supported by a worldwide sales and service organization.

The Kraus & Naimer Registered Trademark



WORLDWIDE SYMBOL
FOR QUALITY SWITCHGEAR

Contents	Page
Programs and Description	4, 5
Complete Standard Units	6, 7
Pre-assembled Front Elements	8, 9
Front Element Components	9, 10
Legend Plates	10, 11
Coupling Plate and Pilot Light Assemblies	11
Series Elements, Contact Blocks and Enclosures	12
Accessories	12-14
Front Plates for Push Buttons	15, 16
Front Plates for Mushroom Push Buttons	17
Color Caps for Pilot Lights	18
Design	19
Dimensions	20-23
Technical Data	24, 25
Blue Line Switchgear: Summary	26

Programs

Push Buttons and Pilot Lights, 22,5 mm Ø

Push buttons and pilot lights by Kraus & Naimer represent an ideal combination of functional security and economical efficiency in a modular design.

Push Buttons

- non-illuminated or illuminated
- flush, extended or with extended front ring
- momentary or latched (for converting into spring return function)

Pilot Lights

- Standard units flush or conical
- Solid pilot lights (direct wire)

Double-Push Buttons

- non-illuminated or illuminated

Emergency Stop Push Buttons

- fool-proof
- non-illuminated or illuminated
- without and with key
- optional mounting in enclosure

Potentiometer

- incl. resistor

Reset Push Buttons

- incl. reset rod

Rotary Switches

- non-illuminated or illuminated
- without and with key
- momentary (for converting into spring return function)

Cam Switches

- ON/OFF switches and double-throw switches
- protection IP 65
- for further cam switches, refer to Catalog 120

Enclosures

- plastic yellow or gray
- with 1, 2, 3, 4 or 6 positions

Legend Options

- front plates and color caps
- legend inserts

Accessories

- a wide range of accessories are available, e.g. protection shrouds and protection caps

Environmentally compatible Materials

- cadmium and asbestos-free
- recyclable

Selection

- complete units
- pre-assembled front elements
- individual components

Front Element

Legend Plate

Fixation Ring

Coupling Plate

Contact Blocks LED Pilot Light Assemblies

Front Elements

- ergonomical design, front rings metallic colored or black
- illuminated elements offer excellent brightest and contrast in all light conditions
- pilot lights with perfect light due to special lenses
- any inscription, abrasion-resistant by laser
- latched push buttons and rotary switches are convertible into spring return function
- mushroom push buttons with large points
- high protection and food resistance: push buttons and pilot lights IP 67/IP 69K, double-push buttons and rotary switches IP 66
- for special operating available with protection caps

Legend Plates

- for front elements and double-push buttons
- with legend inserts
- available with lasered or engraved inscription

Fixation Nut

- is part of the front element
- nut key for fixation nut as accessories

Coupling Plate

- for contact blocks and LED pilot light assemblies
- for max. 3 elements per contact level
- up to 6 contacts on 2 contact levels are possible

Contact Blocks and LED Pilot Light Assemblies

- finger-proof and open terminals (IP 20)
- captive mounting screws
- low overall depth, for mounting in commercial plaster depth box

Contact Blocks

- available as N/C and N/O
- high switching capacity, both in AC-15- and DC-13-operation (technical data see page 22)

LED Pilot Light Assemblies

- in green, red and white color
- long life (100 000 running hours) by especially low power consumption and vibration resistance
- with only 2 voltage ranges the worldwide common applications are covered
- for decoupled function control LED series elements are available

Program Completion

For extensive and complicated switching programs we recommend the use of cam switches size S00 described in Catalog 120. The design and appearance closely match the described push buttons and pilot lights.

Order Information

By changing the order text from P SN to P SB the unit will be specified with black front ring.

Description

Push Buttons and Pilot Lights, 22,5 mm Ø

The modular design of the series push buttons and pilot lights meets your personal requirements in every respect.

Front Elements

Push buttons non-illuminated

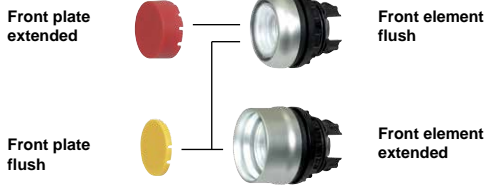

Push buttons illuminated

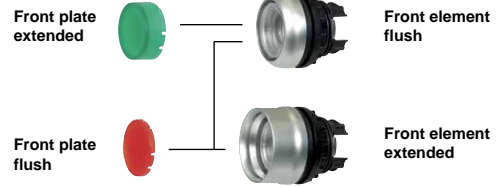

Mushroom push buttons

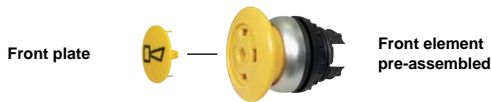

Rotary switches



Double-push buttons



Emergency stop push buttons



Pilot lights

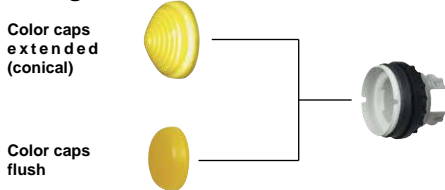

Solid pilot lights



Contact Blocks and LED Pilot Light Assemblies

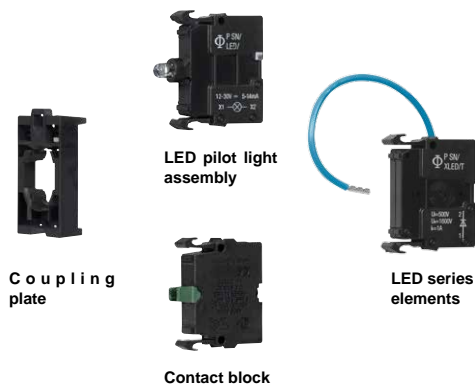

Potentiometer











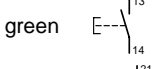
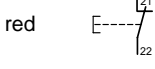
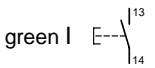
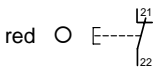

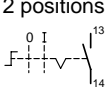
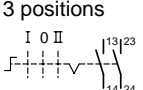
Cam switches





















[< back to table of contents >](#)

Complete Standard Units

Push Buttons Pilot Lights	Code	Rotary Switches Double-Push Buttons, Potentiometer	Code
<p>Push buttons flush, IP 67/IP 69K non-illuminated</p>  <p>green </p> <p>red </p> <p>green I </p> <p>red O </p>	<p>P SN-WD0001</p> <p>P SN-WD0002</p> <p>P SN/D/G/X1-K10</p> <p>P SN/D/R/X0-K01</p>	<p>Rotary switches, IP 66 non-illuminated, latched (changeable by coding pieces to spring return function)</p>  <p>2 positions </p> <p>3 positions </p> 	<p>P SN/WRK-K10</p> <p>P SN/WRK3-K20</p>
<p>Pilot lights flush, IP 67/IP 69K with LED element</p>  <p>green 12 V-30 V AC/DC</p> <p>red 12 V-30 V AC/DC</p> <p>green 85 V-264 V AC</p> <p>red 85 V-264 V AC</p>	<p>P SN-WD0003</p> <p>P SN-WD0004</p> <p>P SN-WD0005</p> <p>P SN-WD0006</p>	<p>Double-push buttons, IP 67/IP 69K with LED element, color cap opaque</p>  <p>85 V-264 V AC</p> <p>green I </p> <p>red O </p>	<p>P SN/DDJ/GR/X1-X0-K11</p>
<p>Solid pilot lights, IP 67/IP 69K for direct wire (without bulb), bulb holder BA 9s</p> <p>flush</p>  <p>green</p> <p>red</p> <p>yellow</p> <p>blue</p> <p>opaque</p>	<p>P SN/LC/G</p> <p>P SN/LC/R</p> <p>P SN/LC/Y</p> <p>P SN/LC/B</p> <p>P SN/LC/W</p>	<p>Potentiometer, IP 66 3 separate screw terminals, $P_{max.} = 0,5 W$</p>  <p>1 kΩ</p> <p>4,7 kΩ</p> <p>10 kΩ</p>	<p>P SN/R1K</p> <p>P SN/R4K7</p> <p>P SN/R10K</p>
<p>extended (conical)</p>  <p>green</p> <p>red</p> <p>yellow</p> <p>blue</p> <p>opaque</p>	<p>P SN/LCH/G</p> <p>P SN/LCH/R</p> <p>P SN/LCH/Y</p> <p>P SN/LCH/B</p> <p>P SN/LCH/W</p>	<p>Other resistance values on request.</p>	







[< back to table of contents >](#)

Complete Standard Units

Emergency Stop Push Buttons	Code	Cam Switches	Code
<p>Emergency stop push buttons, IP 66/IP 69K fool-proof acc. to ISO 13850/EN 418 reset by pulling complement max: 4 contact blocks</p>  <p>red </p> <p>red </p>	<p>P SN/PV-K01</p> <p>P SN/PV-K11</p>	<p>Cam switches, IP 65 ON/OFF switches</p> <p>1 pole</p>   	<p>CG4 A200-600 FS1</p> <p>CG4 A290-600 FS1</p>
<p>reset by key operation 1 key, locking MS1</p>  <p>red </p>	<p>P SN/PVS-K01</p>	<p>Double-throw switches</p>   <p>1 pole</p> <p>2 pole</p>	<p>CG4 A210-600 FS1</p> <p>CG4 A211-600 FS1</p>
<p>top yellow, bottom black reset by pulling complement max: 3 contact blocks</p>  <p>red </p> <p>red </p>	<p>P SN/PV-KC11-IY</p> <p>P SN/PV-KC02-IY</p>	<p>Double-throw switches with spring return to center</p> <p>1 pole</p>  	<p>CG4 A214-600 FS1</p>
<p>foot and palm switch, IP 67/IP 69K top yellow, bottom black reset by pulling</p>  <p>red </p>	<p>P FT/R-V-KC01-IY</p>	<p>Double-throw switches with electrically isolated contacts</p> <p>1 pole</p>  	<p>CG4 A710-600 FS1</p>
		<p>For further cam switches, refer to Catalog 120.</p>	

[< back to table of contents >](#)

Pre-assembled Front Elements







Push Buttons Pilot Lights	Code	Rotary Switches Double-Push Buttons	Code					
Push buttons, IP 67/IP 69K 	flush, non-illuminated	Rotary switches, IP 66 switching angle 60°, latched ¹ 2 positions, non-illuminated  3 positions, non-illuminated 2 positions, illuminated  3 positions, illuminated Rotary switches, key operated, IP 66 switching angle 60°, latched ¹ 1 key, locking MS1 2 positions key can be removed in O I key can be only removed in O  3 positions key can be removed in I O II key can be only removed in O Double-push buttons, IP 67/IP 69K color cap opaque 	green red green I red O flush, illuminated green red green I red O	P SN/D/G P SN/D/R P SN/D/G/X1 P SN/D/R/X0 P SN/DL/G P SN/DL/R P SN/DL/G/X1 P SN/DL/R/X0	P SN/WRK P SN/WKV P SN/WRK3 P SN/WRLK/G P SN/WRLK/R P SN/WRLK/Y P SN/WRLK/B P SN/WRLK/W P SN/WRLK3/G P SN/WRLK3/R P SN/WRLK3/Y P SN/WRLK3/B P SN/WRLK3/W			
	green red extended, illuminated green red		P SN/DH/G P SN/DH/R P SN/DLH/G P SN/DLH/R	green red yellow blue opaque green red yellow blue opaque	P SN/DH/G P SN/DH/R P SN/DLH/G P SN/DLH/R	P SN/WRLK3/G P SN/WRLK3/R P SN/WRLK3/Y P SN/WRLK3/B P SN/WRLK3/W		
	Pilot lights, IP 67/IP 69K flush 		green red yellow blue opaque	P SN/L/G P SN/L/R P SN/L/Y P SN/L/B P SN/L/W	P SN/WRS P SN/WRS/A1			
			extended (conical) 	green red yellow blue opaque	P SN/LH/G P SN/LH/R P SN/LH/Y P SN/LH/B P SN/LH/W	P SN/WRS3 P SN/WRS3/A1 P SN/DDL/GR P SN/DDL/GR/X1-X0 P SN/DDL/GR/GB1-GB0 P SN/DDL/S/X7-X7		
				green red green I red O green red black black	P SN/DL/G P SN/DL/R P SN/DL/G/X1 P SN/DL/R/X0	green red yellow blue opaque green red yellow blue opaque green red yellow blue opaque	P SN/DL/G P SN/DL/R P SN/DL/G/X1 P SN/DL/R/X0	P SN/WRLK/G P SN/WRLK/R P SN/WRLK/Y P SN/WRLK/B P SN/WRLK/W P SN/WRLK3/G P SN/WRLK3/R P SN/WRLK3/Y P SN/WRLK3/B P SN/WRLK3/W
				green red yellow blue opaque	P SN/DH/G P SN/DH/R P SN/DLH/G P SN/DLH/R	green red yellow blue opaque green red yellow blue opaque	P SN/DH/G P SN/DH/R P SN/DLH/G P SN/DLH/R	P SN/WRLK3/G P SN/WRLK3/R P SN/WRLK3/Y P SN/WRLK3/B P SN/WRLK3/W
				green red yellow blue opaque	P SN/L/G P SN/L/R P SN/L/Y P SN/L/B P SN/L/W	P SN/WRS P SN/WRS/A1	P SN/WRS P SN/WRS/A1	
	green red yellow blue opaque			P SN/LH/G P SN/LH/R P SN/LH/Y P SN/LH/B P SN/LH/W	P SN/WRS3 P SN/WRS3/A1 P SN/DDL/GR P SN/DDL/GR/X1-X0 P SN/DDL/GR/GB1-GB0 P SN/DDL/S/X7-X7	P SN/WRS3 P SN/WRS3/A1 P SN/DDL/GR P SN/DDL/GR/X1-X0 P SN/DDL/GR/GB1-GB0 P SN/DDL/S/X7-X7		

[< back to table of contents >](#)

¹changeable by coding pieces to spring return function (40° switching angle)









Pre-assembled Front Elements

Front Element Components

Emergency Stop Push Buttons Reset Units	Code	Push Buttons Front Plates	Code
<p>Emergency stop push buttons IP 67/IP 69K (turning) IP 66/IP 69K (pulling) fool-proof acc. to ISO 13 850/EN 418 complement max.: 4 contact blocks</p> <p>non-illuminated</p> <p>reset by pulling red</p> <p>reset by turning red</p>	<p>P SN/PV</p> <p>P SN/PVT</p>	<p>Push buttons, IP 67/IP 69K without front plate with flush front ring, non-illuminated</p>  <p>momentary</p> <p>latched</p>	<p>P SN/D/X</p> <p>P SN/DR/X</p>
 <p>illuminated</p> <p>reset by pulling red</p> <p>reset by turning red</p>	<p>P SN/PVL</p> <p>P SN/PVLT</p>	<p>Push buttons, IP 67/IP 69K without front plate with extended front ring, non-illuminated</p>  <p>momentary</p>	<p>P SN/DG/X</p>
<p>reset by key operation 1 key, locking MS1</p> <p>red</p> 	<p>P SN/PVS</p>	<p>Front plates, flush</p> <p>green</p> <p>red</p> <p>yellow</p> <p>blue</p> <p>white</p> <p>black</p> <p>legends see page 13</p> 	<p>P SN/XD/G</p> <p>P SN/XD/R</p> <p>P SN/XD/Y</p> <p>P SN/XD/B</p> <p>P SN/XD/W</p> <p>P SN/XD/S</p>
<p>Reset units, IP 67/IP 69K non-illuminated</p> <p>blue RESET</p> <p>blue R</p> 	<p>P SN/DZ/B/GB14</p> <p>P SN/DZ/B/X6</p>	<p>Front plates, extended</p> <p>green</p> <p>red</p> <p>yellow</p> <p>blue</p> <p>white</p> <p>black</p> <p>legends see page 13</p> 	<p>P SN/XDH/G</p> <p>P SN/XDH/R</p> <p>P SN/XDH/Y</p> <p>P SN/XDH/B</p> <p>P SN/XDH/W</p> <p>P SN/XDH/S</p>









[< back to table of contents >](#)

Front Element Components and Legend Plates

Mushroom Push Buttons Front Plates, Push Buttons	Code	Front Plates, Pilot Lights Color Caps, Emergency Stop Plates	Code
<p>Mushroom push buttons, IP 67/IP 69K without front plate</p>  <p>momentary</p> <p>green</p> <p>red</p> <p>yellow</p> <p>black</p> <p>latched</p> <p>green</p> <p>red</p> <p>yellow</p> <p>black</p>	<p>P SN/DP/G/X</p> <p>P SN/DP/R/X</p> <p>P SN/DP/Y/X</p> <p>P SN/DP/S/X</p> <p>P SN/DRP/G/X</p> <p>P SN/DRP/R/X</p> <p>P SN/DRP/Y/X</p> <p>P SN/DRP/S/X</p>	<p>Front plates, flush</p> <p>green</p> <p>red</p> <p>yellow</p> <p>blue</p> <p>opaque</p> <p>legends see page 14</p>  <p>Front plates, extended</p> <p>green</p> <p>red</p> <p>yellow</p> <p>blue</p> <p>opaque</p> <p>legends see page 14</p>  <p>Pilot light, IP 67, IP 69K flush, without color cap</p> 	<p>P SN/XDL/G</p> <p>P SN/XDL/R</p> <p>P SN/XDL/Y</p> <p>P SN/XDL/B</p> <p>P SN/XDL/W</p> <p>P SN/XDLH/G</p> <p>P SN/XDLH/R</p> <p>P SN/XDLH/Y</p> <p>P SN/XDLH/B</p> <p>P SN/XDLH/W</p> <p>P SN/L/X</p>
<p>Front plates</p>  <p>green</p> <p>red</p> <p>yellow</p> <p>white</p> <p>black</p> <p>legends see page 15</p>	<p>P SN/XDP/G</p> <p>P SN/XDP/R</p> <p>P SN/XDP/Y</p> <p>P SN/XDP/W</p> <p>P SN/XDP/S</p>		
<p>Push buttons, IP 67/IP 69K without front plate with flush front ring, illuminated</p>  <p>momentary</p> <p>latched</p>	<p>P SN/DL/X</p> <p>P SN/DRL/X</p>	<p>Color caps</p> <p>green</p> <p>red</p> <p>yellow</p> <p>blue</p> <p>opaque</p> <p>legends see page 16</p> 	<p>P SN/XL/G</p> <p>P SN/XL/R</p> <p>P SN/XL/Y</p> <p>P SN/XL/B</p> <p>P SN/XL/W</p>
<p>Push buttons, IP 67/IP 69K without front plate with extended front ring, illuminated</p>  <p>momentary</p>	<p>P SN/DGL/X</p>	<p>Emergency stop plates, IP 66 rectangular</p> <p>33 mm x 50 mm</p> <p>German</p> <p>English</p>  <p>square, in four languages</p> <p>50 mm x 50 mm</p> 	<p>P SN/XZK/D99</p> <p>P SN/XZK/GB99</p> <p>P SN/XYK1</p>

[< back to table of contents >](#)









Legend Plates, Coupling Plate and Pilot Light Assemblies

Emergency Stop Plates Legend Carrier, Legend Insert	Code	Legend Plates, Coupling Plate LED Pilot Light Assemblies	Code
Emergency stop plates, IP 66 round, in four languages  Ø 90 mm Ø 60 mm	P SN/XAK1 P SN/XBK1	Legend plates, IP 66 complete standard unit 	0 I 0 I I 0 II STOP START Aus OFF Ein ON Störung FAULT Betrieb RUN HAND AUTO MAN. AUTO Aus Ein OFF ON HAND 0 AUTO MAN. 0 AUTO
Legend carrier, IP 66 without plate  for push buttons	P SB/ST/X	Coupling plate 	P SN/A
 for double-push buttons	P SB/STDD/X	LED pilot light assemblies front mounting 	12 V-30 V AC/DC green red white ¹ 85 V-264 V AC green red white ¹
Legend insert 	P SN/XST	base mounting 	12 V-30 V AC/DC green red white ¹ 85 V-264 V AC green red white ¹

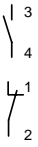

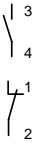





[< back to table of contents >](#)

¹can be combined with blue, yellow or white pilot lights

Series Elements, Contact Blocks, Enclosures and Accessories







LED Series Elements Contact Blocks, Enclosures	Code	Enclosures Blanking Plug, Lamps	Code																								
<p>LED series elements for front mounting and base mounting</p>  <p>resistor element for 42 V-60 V AC/DC for pilot light assemblies 12 V-30 V AC/DC</p> <p>LED test elements for decoupled operational test for connecting to: 12 V-30 V AC/DC</p> <p>85 V-264 V AC</p>	<p>P SN/XLED60</p> <p>P SN/XLED/T</p> <p>P SN/XLED230/T</p>	<p>Plastic enclosure, IP 67/IP 69K totally insulated, lid screws made of stainless steel</p> <p>top gray, bottom black</p>  <p>control positions Ø 22,5 mm</p> <p>1</p>	<p>P SN/I1</p>																								
<p>Contact blocks front mounting</p>  	<p>P SN/K10</p> <p>P SN/K01</p>	<p>top gray, bottom black</p>  <p>control positions Ø 22,5 mm</p> <p>2</p> <p>3</p> <p>4</p> <p>6</p>	<p>P SN/I2</p> <p>P SN/I3</p> <p>P SN/I4</p> <p>P SN/I6</p>																								
<p>for plastic enclosures</p>  	<p>P SN/KC10</p> <p>P SN/KC01</p>	<p>Blanking plug, IP 67/IP 69K gray, for surplus control positions</p> 	<p>P SN/B</p>																								
<p>Plastic enclosure, IP 67/IP 69K totally insulated, lid screws made of stainless steel</p> <p>top yellow, bottom black</p>  <p>control positions Ø 22,5 mm</p> <p>1</p>	<p>P SN/IY1</p>	<p>Lamps, BA 9s for solid pilot lights</p> <p>filament bulbs</p> <table border="0"> <tr> <td>6 V</td> <td>2 W</td> <td>P SN/GL6</td> </tr> <tr> <td>12 V</td> <td>2 W</td> <td>P SN/GL12</td> </tr> <tr> <td>24 V</td> <td>2 W</td> <td>P SN/GL24</td> </tr> <tr> <td>48 V</td> <td>2 W</td> <td>P SN/GL48</td> </tr> <tr> <td>60 V</td> <td>2 W</td> <td>P SN/GL60</td> </tr> <tr> <td>110 V-130 V</td> <td>2,4 W</td> <td>P SN/GL130</td> </tr> </table> <p>neon bulbs</p> <table border="0"> <tr> <td>110 V-130 V AC</td> <td>0,1 W</td> <td>P SN/GIL110K</td> </tr> <tr> <td>220 V-240 V AC</td> <td>0,33 W</td> <td>P SN/GIL220K</td> </tr> </table> 	6 V	2 W	P SN/GL6	12 V	2 W	P SN/GL12	24 V	2 W	P SN/GL24	48 V	2 W	P SN/GL48	60 V	2 W	P SN/GL60	110 V-130 V	2,4 W	P SN/GL130	110 V-130 V AC	0,1 W	P SN/GIL110K	220 V-240 V AC	0,33 W	P SN/GIL220K	
6 V	2 W	P SN/GL6																									
12 V	2 W	P SN/GL12																									
24 V	2 W	P SN/GL24																									
48 V	2 W	P SN/GL48																									
60 V	2 W	P SN/GL60																									
110 V-130 V	2,4 W	P SN/GL130																									
110 V-130 V AC	0,1 W	P SN/GIL110K																									
220 V-240 V AC	0,33 W	P SN/GIL220K																									

Accessories

Bulb Extractor Protection Caps	Code	Protective Shrouds Rod Link, Coding Pieces	Code
<p>Bulb extractor</p> 	<p>P SN/LG</p>	<p>Protective shroud, IP 66 protection against accidental operation for push buttons and rotary switches (cannot be combined with legend plates)</p> 	<p>P SN/XGWK</p>
<p>Protection caps, IP 67 transparent, for aggravating environments (not in food areas) (cannot be combined with legend plates)</p>  <p>push buttons, flush pilot lights, flush</p>	<p>P SN/T/D</p>	<p>Protective shroud, IP 65 yellow, for emergency stop buttons (cannot be combined with legend plates)</p> 	<p>P SN/XGPV</p>
<p></p> <p>double-push buttons</p>	<p>P SN/T/DD</p>	<p>Rod link for operating the middle contact block of non- illuminated rotary switches with 3 positions</p> 	<p>P SN/XW</p>
<p>Protection cap prevents dirt and dust from getting into the key- hole (not food resistant)</p>  <p>rotary switches, key operated</p>	<p>P SN/XWS</p>	<p>Coding pieces for rotary switches to convert the latched function into spring return function (1 kit = 2 pieces)</p> 	<p>P SN/XC/Y</p>

[< back to table of contents >](#)

Accessories

Track Adapter Nut Key	Code	Fixation Nut Spare Key	Code
<p>Track adapter for tracks acc. to EN 60715 for front mounted units</p> 	<p>P SN/IVS</p>	<p>Fixation nut for push buttons, pilot lights and rotary switches</p> 	<p>P SN/GR</p>
<p>Nut key for push buttons, pilot lights and rotary switches</p> 	<p>P SN/MS</p>	<p>for cam switches</p> 	<p>S00 T170 10</p>
<p>for cam switches</p> 	<p>S00 T170 09</p>	<p>Spare key locking MS1</p> 	<p>P SN/ES/MS1</p>

[< back to table of contents >](#)

Front Plates for Push Buttons

Front Plates for Push Buttons non-illuminated				Code	Code
Color	Legend	Symbol	Meaning	Front Plates flush	Front Plates extended
black	Zu			P SN/XD/S/D2	P SN/XDH/S/D2
	Auf			P SN/XD/S/D3	P SN/XDH/S/D3
	Ab			P SN/XD/S/D4	P SN/XDH/S/D4
red	Aus			P SN/XD/R/D5	P SN/XDH/R/D5
black	Ein			P SN/XD/S/D6	P SN/XDH/S/D6
blue	Entsperren			P SN/XD/B/D14	P SN/XDH/B/D14
black	Vorwärts			P SN/XD/S/D15	P SN/XDH/S/D15
	Rückwärts			P SN/XD/S/D16	P SN/XDH/S/D16
	Heben			P SN/XD/S/D17	P SN/XDH/S/D17
	Senken			P SN/XD/S/D18	P SN/XDH/S/D18
red	STOP			P SN/XD/R/GB0	P SN/XDH/R/GB0
black	STOP			P SN/XD/S/GB0	P SN/XDH/S/GB0
green	START			P SN/XD/G/GB1	P SN/XDH/G/GB1
white	START			P SN/XD/W/GB1	P SN/XDH/W/GB1
black	CLOSE			P SN/XD/S/GB2	P SN/XDH/S/GB2
	UP			P SN/XD/S/GB3	P SN/XDH/S/GB3
	DOWN			P SN/XD/S/GB4	P SN/XDH/S/GB4
red	OFF			P SN/XD/R/GB5	P SN/XDH/R/GB5
black	ON	P SN/XD/S/GB6	P SN/XDH/S/GB6		
	TEST	P SN/XD/S/GB9	P SN/XDH/S/GB9		
blue	RESET	P SN/XD/B/GB14	P SN/XDH/B/GB14		
black	FORWARD	P SN/XD/S/GB15	P SN/XDH/S/GB15		
	REVERSE	P SN/XD/S/GB16	P SN/XDH/S/GB16		
	RAISE	P SN/XD/S/GB17	P SN/XDH/S/GB17		
	LOWER	P SN/XD/S/GB18	P SN/XDH/S/GB18		
red		○	stop	P SN/XD/R/X0	P SN/XDH/R/X0
black		○		P SN/XD/S/X0	P SN/XDH/S/X0
green		I	start	P SN/XD/G/X1	P SN/XDH/G/X1
black		I		P SN/XD/S/X1	P SN/XDH/S/X1
white		I		P SN/XD/W/X1	P SN/XDH/W/X1
green		II		P SN/XD/G/X2	P SN/XDH/G/X2
black		II		P SN/XD/S/X2	P SN/XDH/S/X2
		+	increase	P SN/XD/S/X4	P SN/XDH/S/X4
		-	decrease	P SN/XD/S/X5	P SN/XDH/S/X5
blue		R	reset	P SN/XD/B/X6	P SN/XDH/B/X6
black		↑	guide motion	P SN/XD/S/X7	P SN/XDH/S/X7
		↙		P SN/XD/S/X8	P SN/XDH/S/X8
		✋	hand-control	P SN/XD/S/X9	P SN/XDH/S/X9
		⌚	automatic cycle	P SN/XD/S/X10	P SN/XDH/S/X10
		⊕	inching	P SN/XD/S/X11	P SN/XDH/S/X11
		⏏	disengaging	P SN/XD/S/X12	P SN/XDH/S/X12
		🔓	unlock	P SN/XD/S/X13	P SN/XDH/S/X13
	⚙️	tighten	P SN/XD/S/X14	P SN/XDH/S/X14	
	👉	release	P SN/XD/S/X15	P SN/XDH/S/X15	
	👉	liquid	P SN/XD/S/X16	P SN/XDH/S/X16	
	📣	horn	P SN/XD/S/X17	P SN/XDH/S/X17	

[< back to table of contents >](#)

Front Plates for Push Buttons

Front Plates for Push Buttons illuminated				Code	Code
Color	Legend	Symbol	Meaning	Front Plates flush	Front Plates extended
opaque	Zu			P SN/XDL/W/D2	P SN/XDLH/W/D2
	Auf			P SN/XDL/W/D3	P SN/XDLH/W/D3
	Ab			P SN/XDL/W/D4	P SN/XDLH/W/D4
red	Aus			P SN/XDL/R/D5	P SN/XDLH/R/D5
opaque	Ein			P SN/XDL/W/D6	P SN/XDLH/W/D6
blue	Entsperren			P SN/XDL/B/D14	P SN/XDLH/B/D14
opaque	Vorwärts			P SN/XDL/W/D15	P SN/XDLH/W/D15
	Rückwärts			P SN/XDL/W/D16	P SN/XDLH/W/D16
	Heben			P SN/XDL/W/D17	P SN/XDLH/W/D17
	Senken			P SN/XDL/W/D18	P SN/XDLH/W/D18
red	STOP			P SN/XDL/R/GB0	P SN/XDLH/R/GB0
opaque	STOP			P SN/XDL/W/GB0	P SN/XDLH/W/GB0
green	START			P SN/XDL/G/GB1	P SN/XDLH/G/GB1
opaque	START			P SN/XDL/W/GB1	P SN/XDLH/W/GB1
	CLOSE			P SN/XDL/W/GB2	P SN/XDLH/W/GB2
	UP			P SN/XDL/W/GB3	P SN/XDLH/W/GB3
	DOWN			P SN/XDL/W/GB4	P SN/XDLH/W/GB4
red	OFF	P SN/XDL/R/GB5	P SN/XDLH/R/GB5		
opaque	ON	P SN/XDL/W/GB6	P SN/XDLH/W/GB6		
	TEST	P SN/XDL/W/GB9	P SN/XDLH/W/GB9		
blue	RESET	P SN/XDL/B/GB14	P SN/XDLH/B/GB14		
	FORWARD	P SN/XDL/W/GB15	P SN/XDLH/W/GB15		
opaque	REVERSE	P SN/XDL/W/GB16	P SN/XDLH/W/GB16		
	RAISE	P SN/XDL/W/GB17	P SN/XDLH/W/GB17		
	LOWER	P SN/XDL/W/GB18	P SN/XDLH/W/GB18		
	red		○	stop	P SN/XDL/R/X0
opaque		○		P SN/XDL/W/X0	P SN/XDLH/W/X0
green		I	start	P SN/XDL/G/X1	P SN/XDLH/G/X1
opaque		I		P SN/XDL/W/X1	P SN/XDLH/W/X1
green		II		P SN/XDL/G/X2	P SN/XDLH/G/X2
opaque		II		P SN/XDL/W/X2	P SN/XDLH/W/X2
		+	increase	P SN/XDL/W/X4	P SN/XDLH/W/X4
		-	decrease	P SN/XDL/W/X5	P SN/XDLH/W/X5
blue		R	reset	P SN/XDL/B/X6	P SN/XDLH/B/X6
opaque		↑	guide motion	P SN/XDL/W/X7	P SN/XDLH/W/X7
		↖		P SN/XDL/W/X8	P SN/XDLH/W/X8
		✋	hand-control	P SN/XDL/W/X9	P SN/XDLH/W/X9
		⌚	automatic cycle	P SN/XDL/W/X10	P SN/XDLH/W/X10
		⊕	inching	P SN/XDL/W/X11	P SN/XDLH/W/X11
		⬆️	disengaging	P SN/XDL/W/X12	P SN/XDLH/W/X12
		↔️	unlock	P SN/XDL/W/X13	P SN/XDLH/W/X13
		⚙️	tighten	P SN/XDL/W/X14	P SN/XDLH/W/X14
		🔊	release	P SN/XDL/W/X15	P SN/XDLH/W/X15
		🚰	liquid	P SN/XDL/W/X16	P SN/XDLH/W/X16
		📣	horn	P SN/XDL/W/X17	P SN/XDLH/W/X17

Front Plates for Mushroom Push Buttons

Front Plates for Mushroom Push Buttons				Code
Color	Legend	Symbol	Meaning	
black	Zu			P SN/XDP/S/D2
	Auf			P SN/XDP/S/D3
	Ab			P SN/XDP/S/D4
red	Aus			P SN/XDP/R/D5
black	Ein			P SN/XDP/S/D6
	Vorwärts			P SN/XDP/S/D15
	Rückwärts			P SN/XDP/S/D16
	Heben			P SN/XDP/S/D17
	Senken			P SN/XDP/S/D18
red	STOP			P SN/XDP/R/GB0
black	STOP			P SN/XDP/S/GB0
green	START			P SN/XDP/G/GB1
white	START			P SN/XDP/W/GB1
black	CLOSE			P SN/XDP/S/GB2
	UP			P SN/XDP/S/GB3
	DOWN			P SN/XDP/S/GB4
red	OFF			P SN/XDP/R/GB5
black	ON			P SN/XDP/S/GB6
	TEST	P SN/XDP/S/GB9		
	FORWARD	P SN/XDP/S/GB15		
	REVERSE	P SN/XDP/S/GB16		
	RAISE	P SN/XDP/S/GB17		
	LOWER	P SN/XDP/S/GB18		
red		○	stop	P SN/XDP/R/X0
black		○		P SN/XDP/S/X0
green		I	start	P SN/XDP/G/X1
black		I		P SN/XDP/S/X1
white		I		P SN/XDP/W/X1
green		II		P SN/XDP/G/X2
black		II		P SN/XDP/S/X2
		+	increase	P SN/XDP/S/X4
		-	decrease	P SN/XDP/S/X5
		↑	guide motion	P SN/XDP/S/X7
		↖		P SN/XDP/S/X8
		✋	hand-control	P SN/XDP/S/X9
		@	automatic cycle	P SN/XDP/S/X10
		⊕	inching	P SN/XDP/S/X11
		↕	disengaging	P SN/XDP/S/X12
		⚙	unlock	P SN/XDP/S/X13
		⚙	tighten	P SN/XDP/S/X14
		👉	release	P SN/XDP/S/X15
		👉	liquid	P SN/XDP/S/X16
		📣	horn	P SN/XDP/S/X17

[< back to table of contents >](#)

Color Caps for Pilot Lights

Color Caps for Pilot Lights flush				Code
Color	Legend	Symbol	Meaning	Front Plates flush
opaque	Zu			P SN/XL/W/D2
	Auf			P SN/XL/W/D3
	Ab			P SN/XL/W/D4
red	Aus			P SN/XL/R/D5
opaque	Ein			P SN/XL/W/D6
	Vorwärts			P SN/XL/W/D15
	Rückwärts			P SN/XL/W/D16
	Heben			P SN/XL/W/D17
	Senken			P SN/XL/W/D18
red	STOP			P SN/XL/R/GB0
opaque	STOP			P SN/XL/W/GB0
green	START			P SN/XL/G/GB1
opaque	START			P SN/XL/W/GB1
	CLOSE			P SN/XL/W/GB2
	UP			P SN/XL/W/GB3
	DOWN			P SN/XL/W/GB4
red	OFF			P SN/XL/R/GB5
opaque	ON			P SN/XL/W/GB6
	TEST			P SN/XL/W/GB9
	FORWARD			P SN/XL/W/GB15
	REVERSE	P SN/XL/W/GB16		
	RAISE	P SN/XL/W/GB17		
	LOWER	P SN/XL/W/GB18		
red		○	stop	P SN/XL/R/X0
opaque		○		P SN/XL/W/X0
green		I	start	P SN/XL/G/X1
opaque		I		P SN/XL/W/X1
green		II		P SN/XL/G/X2
opaque		II		P SN/XL/W/X2
		+	increase	P SN/XL/W/X4
		-	decrease	P SN/XL/W/X5
		↑	guide motion	P SN/XL/W/X7
		↖		P SN/XL/W/X8
		✋	hand-control	P SN/XL/W/X9
		⊙	automatic cycle	P SN/XL/W/X10
		⊕	inching	P SN/XL/W/X11
		↕	disengaging	P SN/XL/W/X12
		⚙	unlock	P SN/XL/W/X13
		⚙	tighten	P SN/XL/W/X14
		🔓	release	P SN/XL/W/X15
	🔓	liquid	P SN/XL/W/X16	
🔓	horn	P SN/XL/W/X17		

[< back to table of contents >](#)

Design

Programming and Circuit Design

Programming for converting the latched function into spring return function

Push buttons

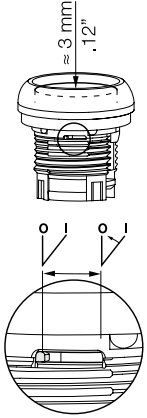

Rotary switches

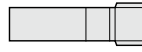
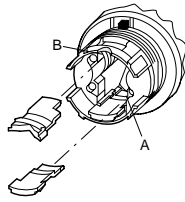

P SN/XC/Y

Rod link for operating the middle contact block of non-illuminated rotary switches with 2 and 3 positions

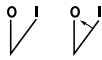
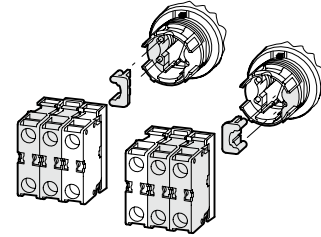

P SN/XC/Y in B

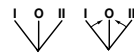

P SN/XC/Y in A and B

Key cannot be removed in spring return position

LED resistor element

P SN/XLED60

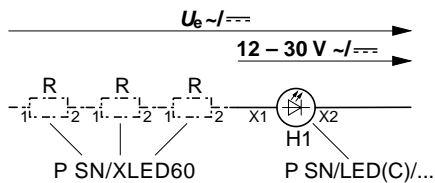

P SN/XLED60	1x	2x	3x	4x	5x	6x	7x
$U_e \leq$	60 V	90 V	120 V	150 V	180 V	210 V	240 V

LED test element

P SN/XLED/T

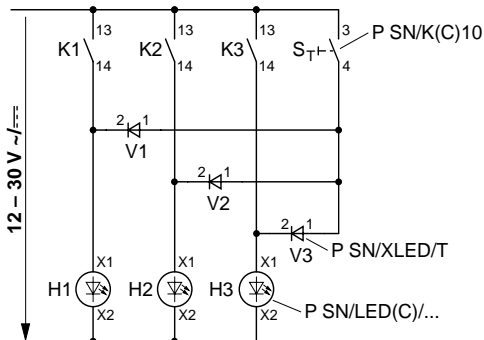

P SN/XLED230/T

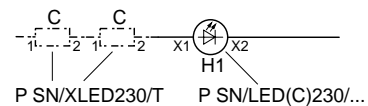
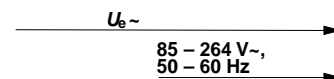
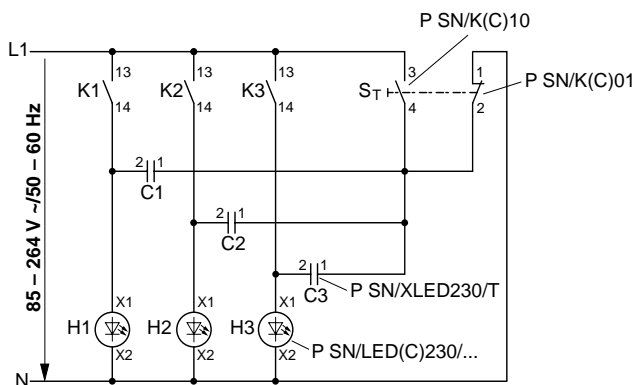

P SN/XLED230/T	1x	2x
$U_e \leq$	400 V AC	500 V AC



Dimensions mm
inch

Operating and Indicator Devices, Push Buttons, Rotary Switches, Rotary Switches key operated, Pilot Lights, Push Buttons illuminated, Mushroom Push Buttons, Solid Pilot Lights, Emergency Stop Push Button, Potentiometer

Operating and indicator devices

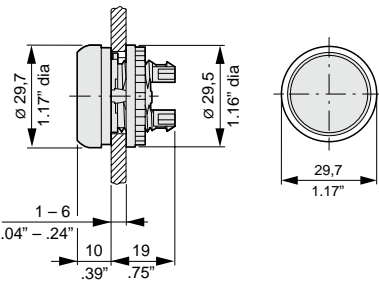

Push buttons

P SN/D

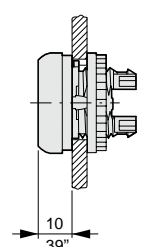

P SN/DH

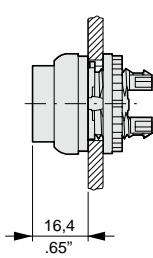

P SN/DG(L)

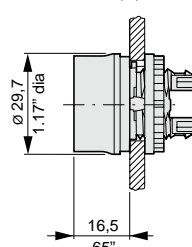

P SN/DD

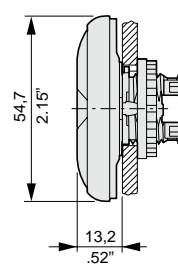

Push buttons P SN/D base mounting

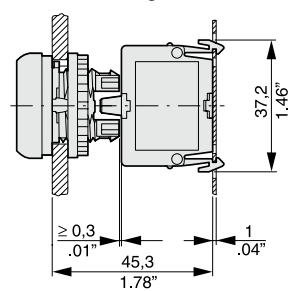

Rotary switches

P SN/W(R)K...
P SN/W(R)LK...

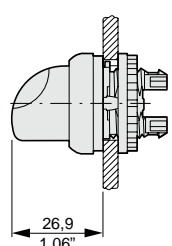

Rotary switches key operated

P SN/WRS

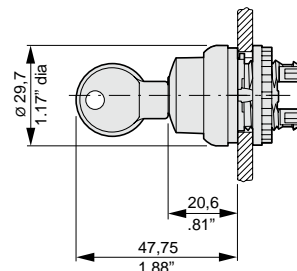

Pilot lights

P SN/LH

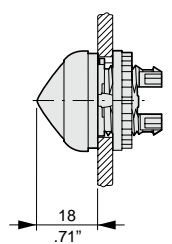

P SN/L

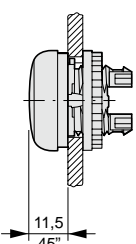

Push buttons illuminated

P SN/DL

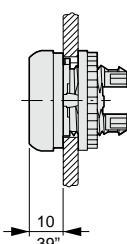

P SN/DLH

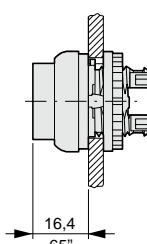

Mushroom push buttons

P SN/DP

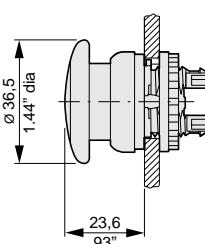

Solid pilot lights

P SN/LC...

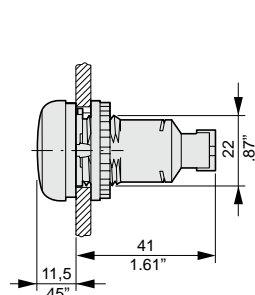

P SN/LCH...

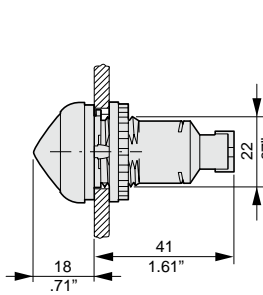

Emergency stop push button

P SN/PV.
P SN/PVT.
P SN/PVL.
P SN/PVS

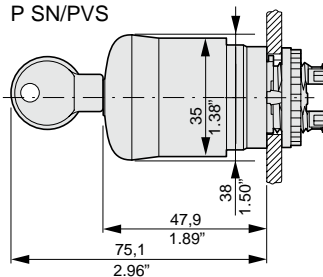

Potentiometer

P SN/R...K

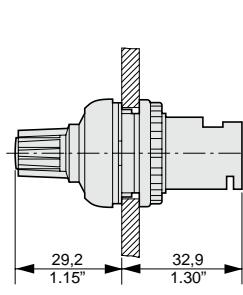

< back to table of contents >

Dimensions mm inch

Front Mounting

Fixing adapter P SN/A

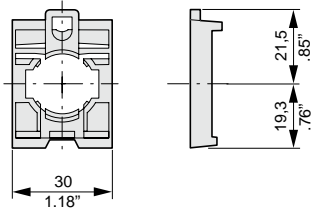

Pilot lights and illuminated push buttons

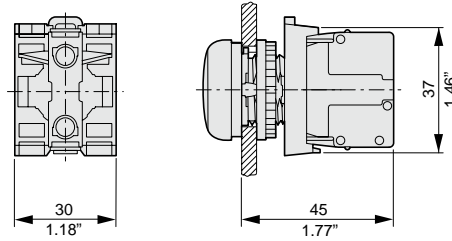

Push buttons with P SN/K... Push buttons with P SN/LED... + P SN/XLED...

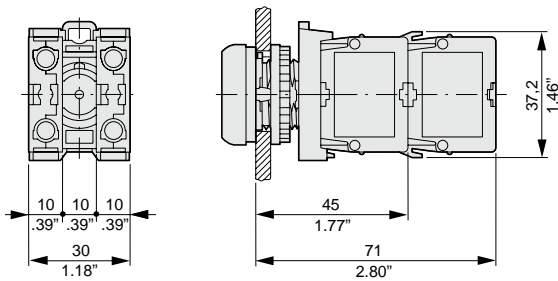

Track adapter

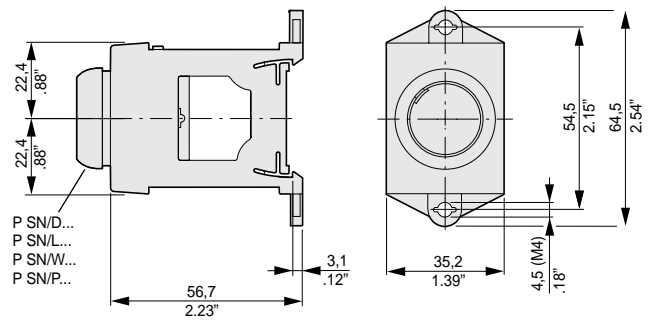

Foot and palm switches P FT/R-V-KC01-IY

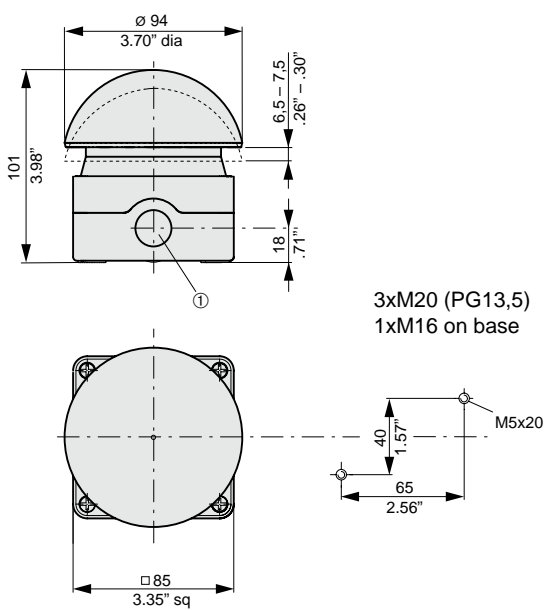

Plastic enclosure

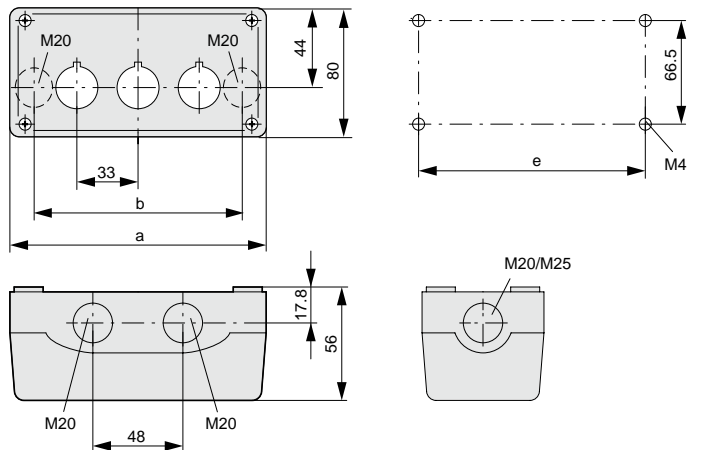

Type	Control positions	a	b	e	Cable entries
P SN/I (Y)1	1	72	42,6	58,5	2xM16 3xM20 2xM25
P SN/I2	2	120	85,6	106,5	2xM20 3xM20 2xM25
P SN/I3	3	153	118,6	139,5	2xM20 2xM25 4xM20
P SN/I4	4	186	151,6	172,5	2xM20 2xM25 4xM20
P SN/I6	6	252	217,6	238,5	2xM20 2xM25 4xM20

[< back to table of contents >](#)

Legend Carrier

Legend carrier
P SB/ST

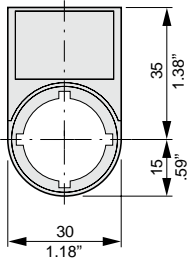

P SB/STDD

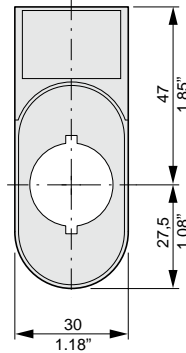

Mounting drilling with slot

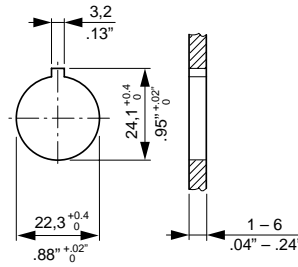

Grid dimension acc. to IEC/EN 60947

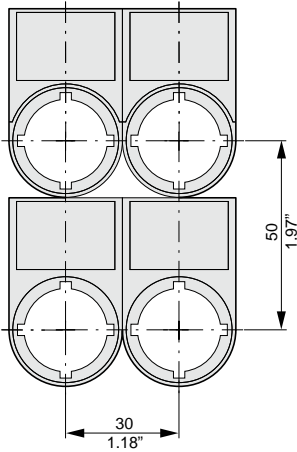

Grid dimension for different combinations

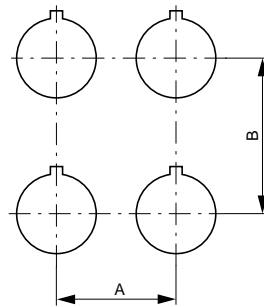

Protection cap with legend carrier cannot be combined

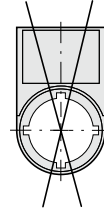

Type	A ≥		B ≥	
	mm	inch	mm	inch
P SN/...(IEC/EN 60947)	30	1.18	50	1.97
P SN/...	30	1.18	40	1.57
P SN/D... + P SN/T/D	33	1.30	40	1.57
P SN/D(R)P...	38	1.50	40	1.57
P SN/PV...	38	1.50	40	1.57
P SN/PV(L...)(S...) + P SN/D...	33	1.30	40	1.57
P SN/DDL...	30	1.18	55	2.17
P SN/DDL... + P SN/T/DD	33	1.30	58	2.28
P SB/ST	30	1.18	50	1.97
P SB/STDD	30	1.18	75	2.95
P SN/XAK...	90	3.54	90	3.54
P SN/XZK...	33	1.30	52	2.05
P SN/XBK...	60	2.36	60	2.36
P SN/XYK...	50	1.97	50	1.97

Grid dimension for P SN/DD...

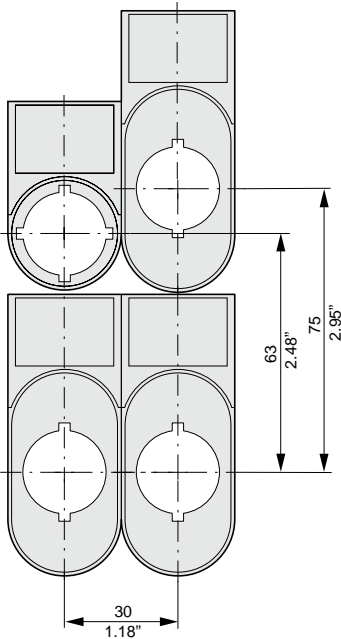

Grid dimension for P SN/DD... with protection cap P SN/T/DD

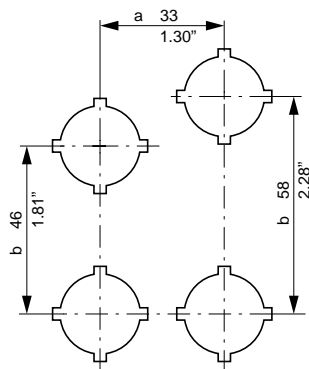

Protection cap and protection shroud with legend carrier cannot be combined

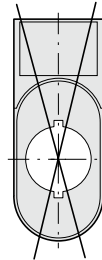

Blanking Plug, Protection Caps, Protective Shroud, Emergency Stop Plates, Cam Switches

Blanking plug
P SN/B

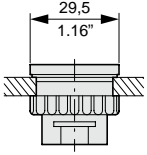

Protection cap
P SN/T/D

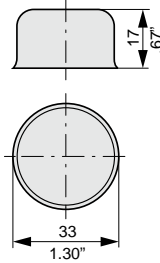

Protection cap
P SN/T/DD

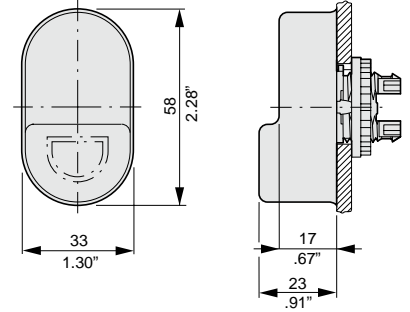

Protective shroud
P SN/XGWK

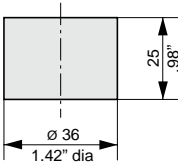

P SN/XGPV

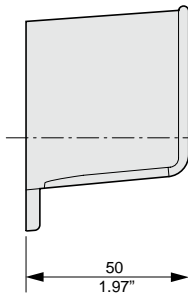
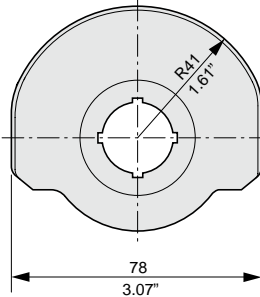

Protection cap
P SN/XWS

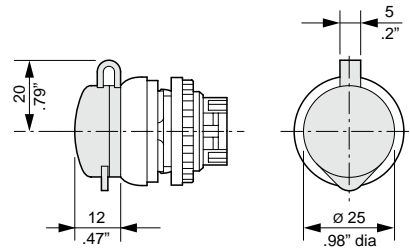

< back to table of contents >

Emergency stop plates
P SN/XAK

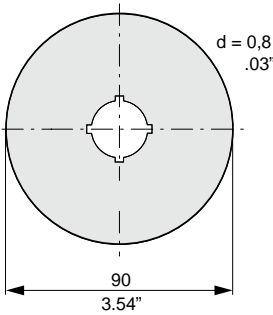

P SN/XZK...

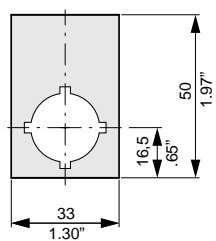

P SN/XBK...

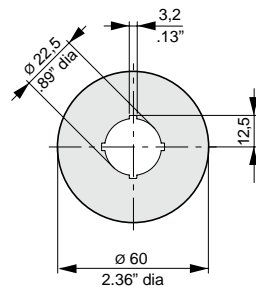

P SN/XYK1

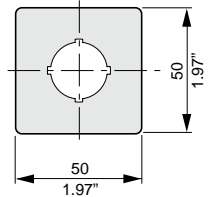

Cam switches

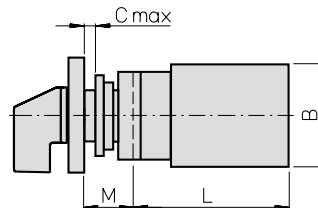
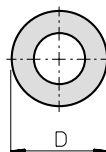
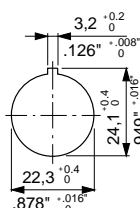
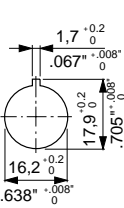

B	C	D	M
28	5	29,5	12,5
1.1	.2	1.16	.49
L 1 stage		L 2 stages	
38,5		50,5	
1.52		1.99	

Technical Data

			Contact Blocks	LED Elements	Push Buttons Mushroom P/B momentary	Double-Push Buttons	Rotary Switches Rotary Switches illuminated	
General								
Standards and requirements			IEC/EN 60947, VDE 0660					
Mechanical life	operations	x 10 ⁶	5	–	5	0,2	0,1	
Max. operating frequency		S/h	3600	–	3600	3600	2000	
Operating force		N	≤ 5	–	≤ 5	≤ 5	–	
Operating torque		Nm	≤ 0,8 (screw terminals)	≤ 0,8 (screw terminals)	–	–	≤ 0,3	
Protection IEC/EN 60529			IP 20	IP 20	IP 67/IP 69K	IP 67/IP 69K	IP 66	
Environmental resistance			humidity, constant, acc. to IEC 60068-2-78					
Ambient temperature			humidity, cyclic, acc. to IEC 60068-2-30					
	open	min./max.	°C	-25/+70	-25/+70 ¹	-25/+70	-25/+70	-25/+70
Mounting position			any					
Shock withstand acc. to IEC 60068-2-27			g					
Shock period 11 ms, 1/2 sinus wave			> 30					
Max. permissible wire gage								
	single core	min.-max.	mm ²	0,75-2,5	0,75-2,5	–	–	–
	stranded wire	min.-max.	mm ²	0,5-2,5	0,5-2,5	–	–	–
Current Paths								
Rated impulse withstand voltage U _{imp}			V	6000	6000	–	–	–
Rated insulation voltage U _i			V	500	500	–	–	–
Overvoltage category/			III/3	III/3	–	–	–	
Pollution degree								
Control circuit reliability at								
	24 V DC/5 mA	fault frequency H _F	< 10 ⁻⁷ , < 1 failure per 10 ⁷ operations					
	5 V DC/1 mA	fault frequency H _F	< 5 x 10 ⁻⁶ , < 1 failure per 5 x 10 ⁶ operations					
Max. fuse size			characteristic	A	gG	10	–	–
Switching Capacity								
Rated operational current I _e								
AC-15								
	115 V	A	6	–	–	–	–	
	230 V	A	6	–	–	–	–	
	400 V	A	4	–	–	–	–	
	500 V	A	2	–	–	–	–	
DC-13								
	24 V	A	3	–	–	–	–	
	42 V	A	1,7	–	–	–	–	
	60 V	A	1,2	–	–	–	–	
	110 V	A	0,8	–	–	–	–	
	220 V	A	0,3	–	–	–	–	
Electrical life								
AC-15								
	230 V/0,5 A	operations	x 10 ⁶	1,6	–	–	–	
	230 V/1,0 A	operations	x 10 ⁶	1,0	–	–	–	
	230 V/3,0 A	operations	x 10 ⁶	0,7	–	–	–	
DC-13								
	12 V/2,8 A	operations	x 10 ⁶	1,2	–	–	–	
Approvals								
Technical data on request.			UL/CSA/GOST	UL/CSA/GOST	UL/CSA/GOST	UL/CSA/GOST	UL/CSA/GOST	

[< back to table of contents >](#)

¹> 200 V AC/60 Hz: -25/+55 °C

Technical Data

			Rotary Switches key operated	Potentiometer Solid Pilot Lights	Pilot Lights	Push Buttons Push Buttons, illuminated Mushroom P/B, latched	Emergency Stop Push Buttons
General							
Standards and requirements			IEC/EN 60947, VDE 0660				
Mechanical life	operations	$\times 10^6$	> 0,1			> 0,1	> 0,1
Max. operating frequency		S/h	100			1800	600
Operating force		N				≤ 5	≤ 50
Operating torque		Nm	$\leq 0,5$				
Protection acc. to IEC/EN 60529			IP 66	IP 66 (Potentiometer) IP 67/IP 69K (pilot light)	IP 67/IP 69K	IP 67/IP 69K	reset by turning IP 67/IP 69K reset by pulling IP 66/IP 69K
Environmental resistance			humidity, constant, acc. to IEC 60068-2-78 humidity, cyclic, acc. to IEC 60068-2-30				
Ambient temperature	open	min./max.	°C	-25/+70	-25/+70	-25/+70	-25/+70
Mounting position				any	any	any	any
Shock withstand acc. to IEC 60068-2-27			g	> 30	> 30	> 30	> 30
Shock period 11 ms, 1/2 sinus wave							
Max. permissible wire gage							
single core	min.-max.	mm ²		0,5-1,5			
stranded wire	min.-max.	mm ²		0,5-1,5			
Current Paths							
Rated impulse withstand voltage U_{imp}		V		4000			
Rated insulation voltage U_i		V		250			
Overvoltage category/ Pollution degree				III/3			
Approvals							
Technical data on request.				UL/CSA/GOST	UL/CSA/GOST	UL/CSA/GOST	UL/CSA/GOST

Foot and Palm Switches latched

General							
Standards and requirements			IEC/EN 60947, VDE 0660				
Mechanical life	operations	$\times 10^6$	> 0,1				
Max. operating frequency		S/h	≤ 600				
Operating force		N	≤ 60				
Protection acc. to IEC/EN 60529			IP 67, IP 69K				
Environmental resistance			humidity, constant, acc. to IEC 60068-2-78 humidity, cyclic, acc. to IEC 60068-2-30				
Ambient temperature	min./max.	°C	-25/+40				
Mounting position			any				
Shock withstand acc. to IEC 60068-2-27		g	> 15				
Shock period 11 ms, 1/2 sinus wave							

Cam Switches CG4¹

General							
Standards and requirements			IEC/EN 60947, VDE 0660				
Rated impulse withstand voltage U_e ²		V	440				
Rated insulation voltage U_{imp} ²		V	4000				
Rated thermal current I_U/I_{th}		A	10				
Rated operational current I_e	AC-21A	A	10				
220 V-240 V	AC-15	A	2,5				
380 V-440 V	AC-15	A	1,5				
Max. fuse size	gG-characteristic	A	10				
Max. permissible wire gage							
single core or stranded wire		mm ²	2 x 1,5				
flexible wire		mm ²	2 x 1,5				
Approvals							
Technical data on request.			UL/CSA/GOST/CCC ³				

¹For further cam switches, refer to Catalog 120. ²Valid for lines with grounded common neutral termination, overvoltage category III, pollution degree 3.

³If this approval is required, please request when ordering.

The Range of “Blue Line” Switchgear

Technical literature covering the following products is available on request.

	Catalog Number
Main Switches and Main Switches with Emergency Function 16 A-315 A Maintenance Switches 20 A-315 A Switch Disconnectors 20 A-315 A According to IEC 60947-3, EN 60947-3, VDE 0660 part 107, IEC 60204, EN 60204 and VDE 0113	500
CL Switches 10 A-20 A C, CA and CAD Switches 10 A-315 A and L Switches 350 A-2400 A C, CA and CAD switches are designed for universal application. They are recommended for instrument, isolator, double-throw and motor control. L switches are designed for load and off-load applications. They are used to switch resistive or low inductive loads.	100
Optional Extras and Enclosures The complete product line, a large number of optional extras is available, including door interlocks, push-pull devices, cylinder and padlock attachments, control and indicator devices, AC motor drives, as well as enclosures, both insulated and metal.	101
A and AD Switches 6 A-25 A A and AD switches have 4 contacts in each switching stage. These switches provide an extensive range of switch functions and require a minimum mounting depth. Up to 36 switching positions are possible, with availability of 48 contacts per 12 stage switch column.	110
CG, CH and CHR Switches 10 A-25 A Ultra compact CG, CH and CHR switches are ideally suited for control and instrumentation applications. Switch terminals are “finger-proof” and conveniently accessible for wiring and are delivered open. All CG4 switches offer specially designed gold plated contacts or H-bridges with “cross-wire” contact systems, which facilitates their use in electronic circuitry and chemically aggressive environments.	120
DH, DHR, DK and DKR Switches 6 A-16 A DH, DHR, DK and DKR switches incorporate unique corrosion resistant contacts that permit operation on system voltage as low as 1 V. They have fully enclosed and protected contacts which can be operated either by rotary and/or lateral handle movement. D switches are used in calibration and semiconductor circuits. They are also used for relay and contactor control.	130
X Switches 80 A-630 A X switches can be applied for load, tap and gang switching duties. They incorporate 6 contacts in each switching stage. Their compact design provides a minimum length dimension for mounting purposes.	140
KG Switches 20 A-315 A and KH and KHR Switches 16 A-80 A KG, KH and KHR switches are excellent circuit interruptors. They have high through fault and fault making capacities and are especially designed for use as isolators and safety switches for machine tools, distribution panels and switchboards. KG ON/OFF switches offer unusually high dimensioned air and creepage distances between terminals which are designed for time saving “straight-line” wiring. ON/OFF switches are available with up to 8 poles and double-throw switches are available with up to 4 poles.	150
Push Buttons and Pilot Lights, 22,5 mm Ø A complete range of state-of-the-art push buttons and pilot lights represent an ideal combination of functional security and economical efficiency in a modular design.	302

SALES AND SERVICE ORGANIZATION

Australia

Kraus & Naimer Pty. Ltd.
379 Liverpool Road, ASHFIELD, N.S.W. 2131
Tel: +61 2 9797-7333, Fax: 0092
salesaus@krausnaimer.com

Austria

Kraus & Naimer GmbH
Schumanngasse 35
1180 WIEN
Tel: +43 1 404 06-0, Fax: 404 06-190
aso@krausnaimer.com

Belgium, Luxembourg

Kraus & Naimer B.V.
Ikaros Business Park
Ikaroslaan 2
B-1930 ZAVENTHEM
Tel: +32 2 757-0141, Fax: 1640
sales.be@krausnaimer.com

Brazil

Central and South America
Kraus & Naimer Ind. Com. Ltda.
Rua Santa Monica, 1061
Parque Industrial San Jose
06715-865 Cotia - SP
Tel: +55 11 2198-1288, Fax: 1251
knbrasil@krausnaimer.com.br

Canada

Kraus & Naimer Ltd.
219 Connie Crescent, Unit: 13A
CONCORD, Ontario, L4K 1L4
Tel: +1 905 738-1666, Fax: 9327
salescan@krausnaimer.com

Cyprus

ELECTROMATIC CONSTRUCTIONS LTD.
72, Evagoras Pellikarides Str., CY-2235 LATSIA-Nicosia
P. O. Box 12630, CY-2251 LATSIA-Nicosia
Tel: +357 2 48 41 41, Fax: 48 57 47

Czech Republic

OBZOR, výrobní družstvo Zlín
Na Slanici 378
CZ-76413 ZLÍN
Tel: +420 57 7195-111/-153 (Techn. Supp.)
Fax: +420 57 7195-152/-138
ots@obzor.cz

Denmark

THIIM A/S
Transformervej 31
DK-2730 HERLEV
Tel: +45 4485 8000, Fax: 8005
thiim@thiim.com

Finland

Kraus & Naimer Oy
Kiitoradankuja 8
FIN-01530 VANTAA
Tel: +358 9 825-424-0, Fax: 424-10
myynti@krausnaimer.com

France

Kraus & Naimer s.a.s.
33, rue Bobillot
F-75013 PARIS
Tel: +33 1 58 40 80 80, Fax: 45 80 91 19
ventes@krausnaimer.com

Germany

Kraus & Naimer GmbH
Wikingerstraße 20-28, D-76189 KARLSRUHE
Postfach 10 01 24, D-76231 KARLSRUHE
Tel: +49 721 59 88-0, Fax: 59 28 28
sales.ger@krausnaimer.com

Great Britain

Kraus & Naimer Ltd.
115 London Road
NEWBURY/BERKSHIRE RG14 2AH
Tel: +44 1635 262626, Fax: 37807
sales-uk@krausnaimer.com

Greece

KALAMARAKIS-SAPOUNAS S. A.
Ionias & Neromilou Str., P. O. Box 46566
GR-13671 ACHARNES/ATHENS
Tel: +30 2 10 240-6000-6, Fax: 240-6007
kalamarakis.sapounas@ksa.gr

Hungary

GANZ, Schalter- u. Gerätefabrik
X. Kőbányal út 41/c, Postfach 87
H-1475 BUDAPEST
Tel: +36 1 261-5479, Fax: 4685
ganzkk@ganzkk.hu

Iceland

BRAEDURNIR ORMSSON EHF
Lágmúli 6-8, P. O. Box 8670
REYKJAVIK
Tel: +354 530-28 00, Fax: 28 10
skuli@ormsson.is

India

BLISS ELECTRICALS Pvt. Ltd.
SA42 A&B, 2nd Flr, Lake City Mall,
Kapurbavdi Junction,
THANE (W) - 400 607
Tel: +91-22-25368609
kane.shriram@blisselectricals.com

Republic of Ireland

Kraus & Naimer Ltd.
4235 Atlantic Avenue
Westpark Business Campus
Shannon, Co. Clare
Tel: +353 61 704700, Fax: 471084
sales-ie@krausnaimer.com

Italy

Kraus & Naimer s.r.l.
Via Terracini, 9
I-24047 TREVIGLIO (BG)
Tel: +39 0363-30 11 12, Fax: 30 21 13
SalesItaly@krausnaimer.com

Japan

Kraus & Naimer Ltd.
Yoshiwada Building 2F
1-11-6 Hamamatsucho
Minato-Ku, TOKYO 105-0013
Tel: +81 3 3436-6151, Fax: 6325
sales-jpn@krausnaimer.com

Mexico

JC Ingeniería y Control, SA de CV.
Ángel Gaviño 30.
C. Satélite, C. Medicos,
Naucalpan Edo. de Mexico, C.P. 53100
Tel. (+52 55) 55 62 75 77, Fax. 55 62 04 34
ventas@jcingenieraycontrol.com

Middle East - UAE

Branch Office, Kraus & Naimer Pte. Ltd.
SAIF Zone, P. O. Box 121607,
Sharjah, UAE
Tel: +971 6 557 8886
Fax: +971 6 557 8088
uae@krausnaimer.com

Netherlands

Kraus & Naimer B.V.
Wegtersweg 38-40, Postbus 199
NL-7556 BR HENGEL0 (Ov.)
Tel: +31 74 291-9441, Fax: 8380
sales.nl@krausnaimer.com

New Zealand

Kraus & Naimer Ltd.
42 Miramar Avenue, WELLINGTON 6022
P. O. Box 15-009, WELLINGTON 6243
Tel: +64 4 380-9888, Fax: 9877
sales-nz@krausnaimer.com

Norway

Kraus & Naimer AS
Hjalmar Brantings vei 8, P. O. Box 21, Økern
N-0508 OSLO
Tel: +47 22 64 44 20, Fax: 65 39 49
ordre.no@krausnaimer.com

Poland

ASTAT sp. z o.o.
ul. Dąbrowskiego 461
PL-60451 POZNAN
Tel: +48 61 848-8871/72, Fax: 8276
info@astat.com.pl

Portugal

ELECTRICOL-DAMAS, FERREIRA & DAMASCENO, LDA.
Apartado 1063, S. Ant. Cavaleiros
P-2670 LOURES
Tel: +351 21 989-8939, Fax: 988-6464
electrical@electricol.pt

Singapore

Kraus & Naimer Pte. Ltd.
Blk 115A, Commonwealth Drive
#03-17/23
SINGAPORE 149 596
Tel: +65 6473-8166, Fax: 8643
sgp@krausnaimer.com

Slovenia

SCHRACK Technik d.o.o.
Pameče 175
SI-2380 Slovenj Gradec
Tel: +386 2 883 92 00, Fax: +386 2 884 34 71
m.abeln@schrack.si

Republic of South Africa

Kraus & Naimer Pty. Ltd.
7 Village Crescent, Linbro Village
Linbro Business Park, SANDTON 2065
P. O. Box 511, KELVIN 2054
Tel: +27 11 608-6060, Fax: 608-2874
salesZAF@krausnaimer.com

Spain

Kraus & Naimer B.V.
Tel: +34 662 696 014
sales.es@krausnaimer.com

Sweden

Kraus & Naimer AB
Dr. Widerströms Gata 11, FRUÅNGEN
Box 42097, S-126 14 STOCKHOLM
Tel: +46 8 97 00 80, Fax: 97 87 33
order.se@krausnaimer.com

Switzerland

AWAG Elektrotechnik AG
Sandbühlstraße 2, Postfach
CH-8604 VOLKETSCHWIL
Tel: +41 44 908 19 19, Fax: 19 99
info@awag.ch, www.awag.ch

Turkey

KARDEŞ ELEKTRİK SANAYİ VE TİCARET ANONİM ŞİRKETİ
Beşyol, Eski Londra Asfaltı-6
TR-34295 İSTANBUL-Sefaköy
Tel: +90 212 624-9204, Fax: 592-4810
info@unalkardes.com.tr

USA

Kraus & Naimer Inc.
760 New Brunswick Road
SOMERSET, NJ 08873
Tel: +1 732 560-1240, Fax: 8823
salesusa@krausnaimer.com



Kraus & Naimer

BLUE LINE switchgear



Contact us:

www.krausnaimer.com