

EVERY JOINT IS DIFFERENT.

EVOTORQUE®2'S INTELLIGENT SENSING TECHNOLOGY ALWAYS DETECTS WHICH TYPE OF JOINT YOU ARE WORKING WITH.

Traditional electronic torque tools give vastly different results depending on the joint type. Norbar's intelligent joint sensing technology eliminates these issues so that you can be confident in your bolting work.

Hard joints
(High Torque Rate*)

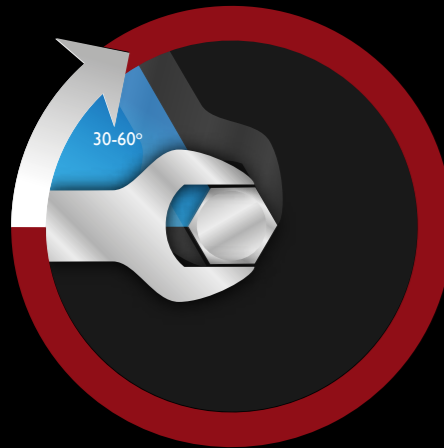

Joints completed within the range 30-60 degrees

Soft joints
(Low Torque Rate*)

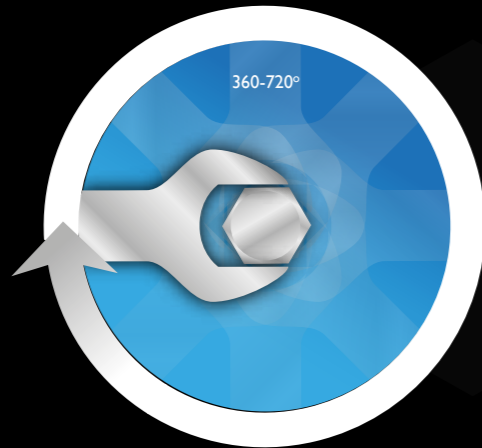

Joints completed within the range 360-720 degrees

*High torque rate and low torque rate as defined by ISO5393 "Rotary tools for threaded fasteners - Performance test method"

ACCURACY OF ELECTRONIC TORQUE TOOLS

First generation

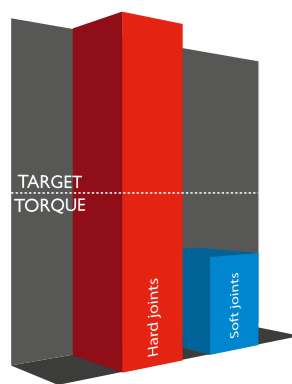

Best of present generation

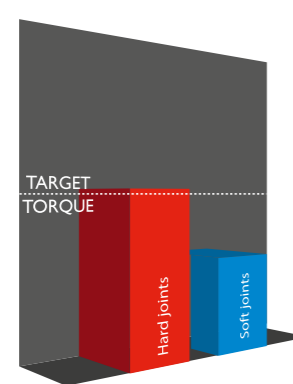

New generation EvoTorque®2

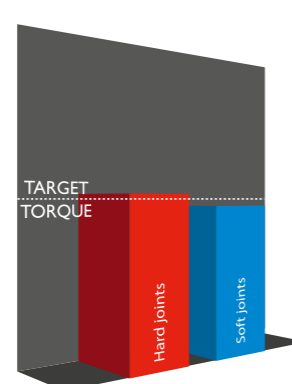

GLOBAL SERVICE

Norbar is the only torque equipment manufacturer capable of offering tool and instrument calibration services to the original factory standard on four continents.

Accredited laboratories in Australia, USA, Singapore, China and India operate the same equipment and procedures as the UKAS accredited laboratory within our headquarters in the UK.



NORBAR TORQUE TOOLS LTD
Wildmere Road, Banbury, Oxfordshire, OX16 3JU
UNITED KINGDOM
Tel + 44 (0)1295 753600
Email sales@norbar.com



NORBAR TORQUE TOOLS
45-47 Raglan Avenue, Edwardstown
SA 5039
AUSTRALIA
Tel + 61 (0)8 8292 9777
Email enquiry@norbar.com.au



NORBAR TORQUE TOOLS INC
36400 Biltmore Place, Willoughby
Ohio 44094
USA
Tel + 1 866 667 2272
Email inquiry@norbar.us



NORBAR TORQUE TOOLS PTE LTD
194 Pandan Loop, #07-20 Pantech Business Hub
SINGAPORE 128383
Tel + 65 6841 1371
Email enquires@norbar.sg



NORBAR TORQUE TOOLS (SHANGHAI) LTD
E Building - 5F, No. 1618 Yishan Road
Minhang District, Shanghai
CHINA 201103
Tel + 86 21 6145 0368
Email sales@norbar.com.cn



NORBAR TORQUE TOOLS INDIA PVT. LTD
Plot No A - 168 Khairne Industrial Area
Thane Belapur Road
Mahape Navi Mumbai - 400 709
INDIA
Tel + 91 22 2778 8480
Email enquiry@norbar.in

www.norbar.com



NORBAR PRODUCT PORTFOLIO

- Torque Screwdrivers
- Torque Wrenches
- Electronic Torque Wrenches
- Manual Torque Multipliers
- Pneumatic Torque Multipliers
- Electronic Torque Multipliers
- Torque Measurement Instruments
- Torque Transducers
- Ultrasonic Bolt Measurement
- Calibration Services

NEW



EVOTORQUE®2 AN EVOLUTION IN TORQUE CONTROL



Distributed by

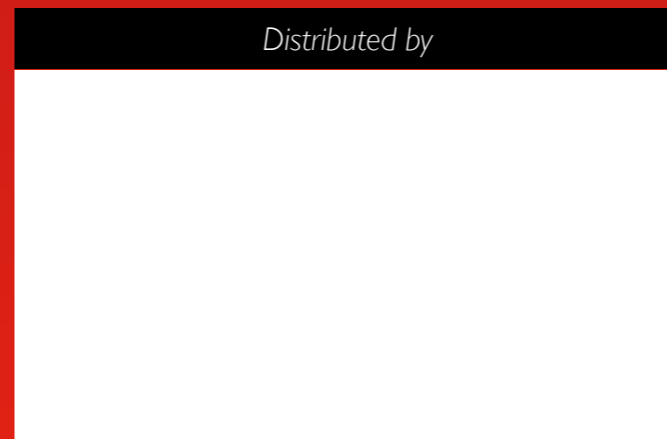

NORBAR HAVE COMBINED PROVEN JOINT SENSING TECHNOLOGY, DATA MEMORY AND TRANSFER CAPABILITIES WITH TORQUE, TORQUE & ANGLE AND AUDIT MODES TO PRODUCE A HIGHLY ACCURATE, USER FRIENDLY, ROBUST AND VERSATILE ELECTRONIC TORQUE TOOL

The EvoTorque®2 is an electronic torque tool designed for accurately applying torque to threaded fasteners. The unique 'intelligent joint sensing' technology continually measures the joint during tightening and, when necessary, employs dynamic braking to avoid torque over-shoot due to motor inertia.

Durable Peli case
- for safer storage
- available at an additional cost

Tool supplied in cardboard case as standard

Brushless motor
for low maintenance

OLED display
ensures visibility in all conditions

Key Lock feature
prevents unauthorised usage

Easily removable secondary handle
for balanced handling of the tool

made in england

Tried and tested gearbox
reliable and proven over more than a decade on the Pneumatic Torque Multiplier platform

Steel reactions
supplied as standard. Bespoke reactions available, please see opposite page

Clear indication
of successful joint application

IP44 protection
against dust and water ingress

On-board control box
making the tool more portable and convenient

KEY FEATURES

- Multiple units of torque measurement, including N-m, lbf-ft, ft-lb and kgf-m
- Factory calibrated to $\pm 3\%$
- Calibrated from 20% to 100% of tool range
- Torque, Torque & Angle and Audit Modes available
- In Torque, Torque & Angle and Audit Modes, torque can be set from 10% of tool maximum
- Display and on-board storage of final torque or torque and angle values
- 3000 reading memory, time and date stamped
- USB and Bluetooth® 4.0 data transfer (also called Bluetooth® Smart)
- Ability to download a lock to the EvoTorque®2 to prevent unauthorised user adjustment
- 12 user IDs can be downloaded to the tool and results can be stored against individual users
- 20 unique standalone targets plus 20 unique work group targets for each work group
- 12 standalone work IDs plus 12 work IDs in each work group

TECHNICAL SPECIFICATION

MODEL	ET-72-1000-110	ET-72-1000-230	ET-72-1350-110	ET-72-1350-230	ET-72-2000-110	ET-72-2000-230	ET-92-2700-110	ET-92-2700-230	ET-92-4000-110	ET-92-4000-230	ET-119-6000-110	ET-119-6000-230
Voltage	110	230	110	230	110	230	110	230	110	230	110	230
Part Number	180230.B06	180220.B06	180231.B06	180221.B06	180232.B08	180222.B08	180233.B08	180223.B08	180234.B08	180224.B08	180235.B12	180225.B12
Square Drive	3/4"	3/4"	3/4"	3/4"	1"	1"	1"	1"	1"	1"	1 1/2"	1 1/2"
Range	N-m	200 - 1000	200 - 1000	270 - 1350	270 - 1350	400 - 2000	400 - 2000	540 - 2700	540 - 2700	800 - 4000	800 - 4000	1200 - 6000
	lbf-ft	148 - 738	148 - 738	199 - 996	199 - 996	295 - 1475	295 - 1475	398 - 1991	398 - 1991	590 - 2950	590 - 2950	885 - 4425
Speed (rpm)	21	21	17	17	11	11	8.5	8.5	6	6	3.3	3.3
Tool Weight	kg	10.4	10.4	10.4	10.4	10.8	12.85	12.85	12.85	12.85	16.8	16.8
	lb	22.9	22.9	22.9	22.9	23.8	28.3	28.3	28.4	28.4	37	37
Reaction Weight	kg	1.5	1.5	1.5	1.5	1.5	2.6	2.6	2.6	2.6	3.9	3.9
	lb	3.3	3.3	3.3	3.3	3.3	5.7	5.7	2.9	2.9	8.6	8.6
B (mm)	390	390	390	390	425	425	450	450	450	450	480	480
C (mm)	435	435	435	435	435	435	435	435	435	435	435	435
D (mm)	77	77	77	77	77	77	75	75	75	75	95	95
E (ø mm)	72	72	72	72	72	72	92	92	92	92	119	119
F (mm)	100	100	100	100	100	100	100	100	100	100	115	115
G (mm)	135.5	135.5	135.5	135.5	135.5	135.5	135.5	135.5	135.5	135.5	135.5	135.5

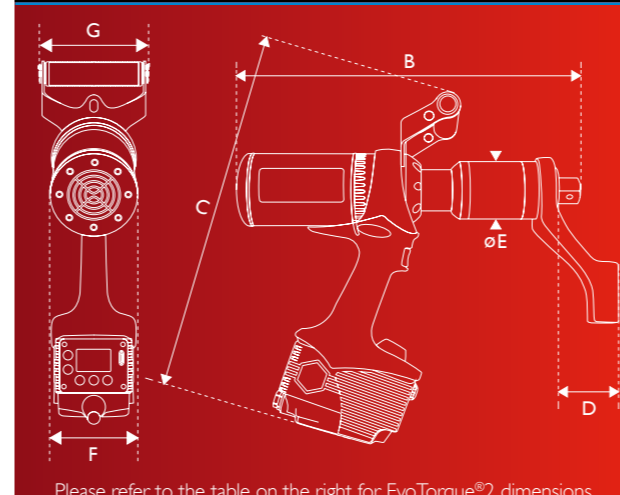

- Supplied with complimentary PC software "EvoLog" for data management and tool configuration
- Send "Log Results" in real time
- Output results in CSV format
- Report generation for archived results
- Compatible with Windows® 10, 8.1, 7, XP (32 bit & 64 bit)
- Connect up to 8 EvoTorque®2 tools simultaneously
- Several reaction plate styles available, including versions for restricted space applications
- Steel and aluminium versions available plus specific reactions for the Wind Industry