



The Theatre Equipment Specialists

SURGICAL INSTRUMENTS

CATALOGUE

GENERAL SURGERY

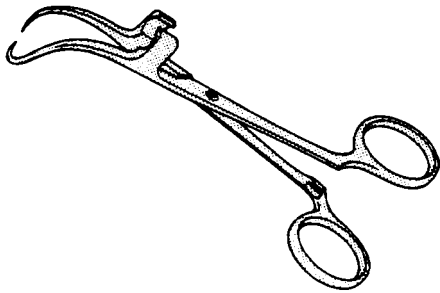

Anchoring Forceps

**Robin**

screw joint

L1005-05 5mm diameter holder for diathermy leads, 140mm**L1005-13** 13mm diameter holder for suction tubing, 140mm**L1005-25** 25mm diameter holder for suction tubing, 140mm

Artery Forceps

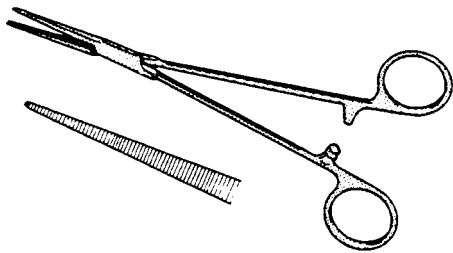
**Adson (Fraser)**

straight

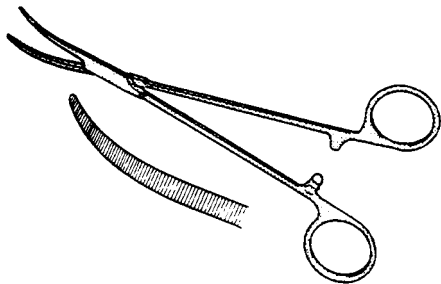
L1017-18 180mm**Adson (Fraser)**

curved

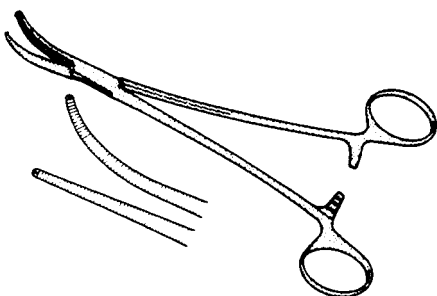
L1018-18 180mm**Adson (Fraser)**

straight, 1/2 teeth

L1019-18 180mm

curved, 1/2

teeth

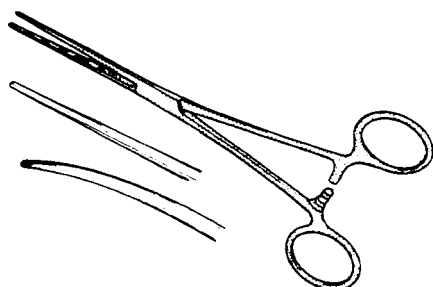
L1020-18 180mm**Bainbridge**

straight

L1023-15 150mm**L1023-18** 180mm

curved

L1024-15 150mm**L1024-18** 180mm

Artery Forceps

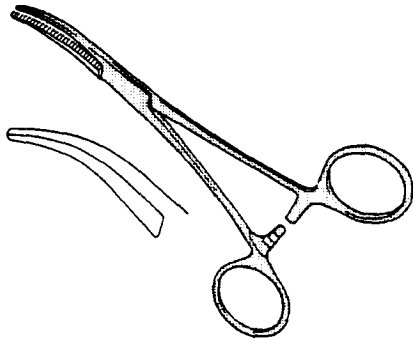
**Dandy**

curved
L1027-14 140mm

**Dieffenbach**

straight
L1030-35 35mm
L1030-50 50mm

**Dieffenbach**

curved
L1031-35 35mm
L1031-50 50mm

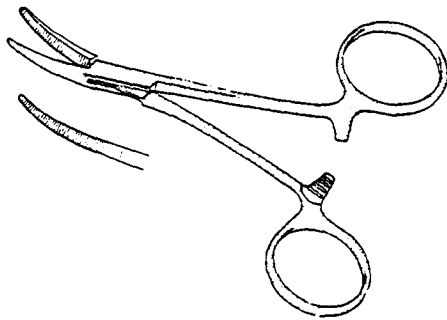
**Dunhill**

curved, box joint
L1034-18 180mm
L1035-12 125mm
straight, box joint
L1035-12 125mm

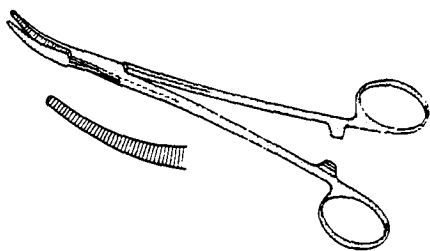
**Fraser Kelly**

curved
L1038-18 180mm

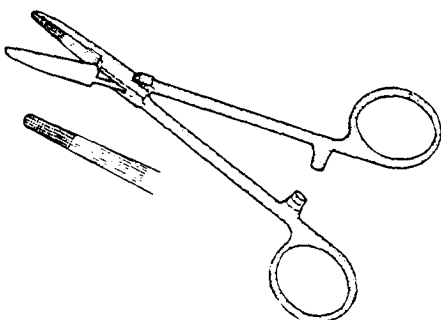
**Grey Turner**

straight
L1040-14 145mm
L1040-18 180mm

Artery Forceps

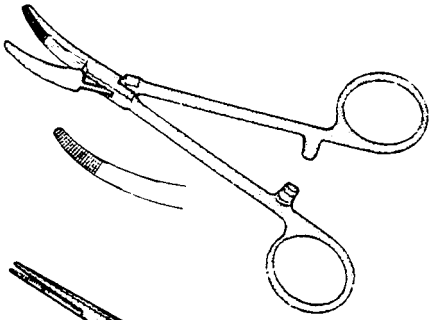
**Grey Turner**

curved
L1041-14 145mm
L1041-18 180mm

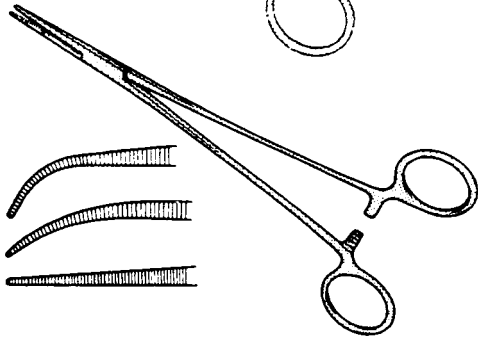
**Heiss**

straight
L1043-20 200mm
 slightly curved
L1043-21 200mm
 curved
L1043-22 200mm

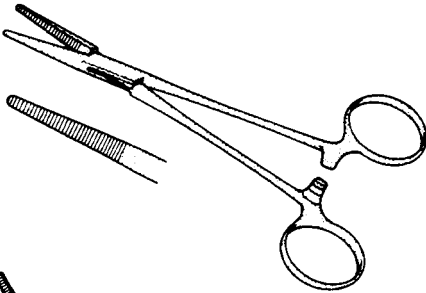
**Kelly-Crile**

straight, half serrated jaws
L1046-14 145mm
L1046-16 160mm

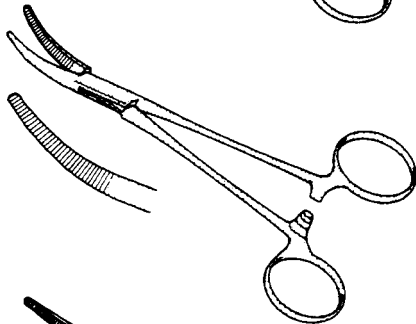
**Kelly-Crile**

curved, half serrated jaw
L1047-14 145mm
L1047-16 160mm

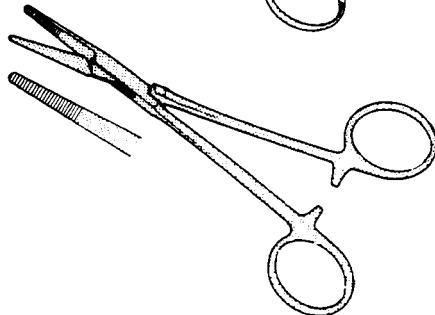
**Kilner**

straight, serrated jaws
L1050-14 140mm

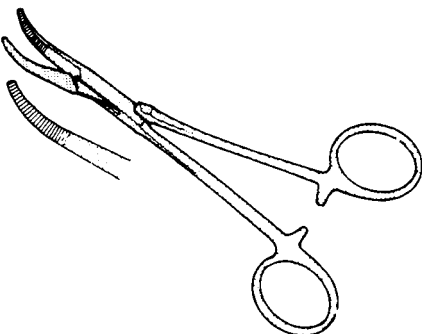
**Kilner**

curved, serrated jaws
L1051-14 140mm

Artery Forceps

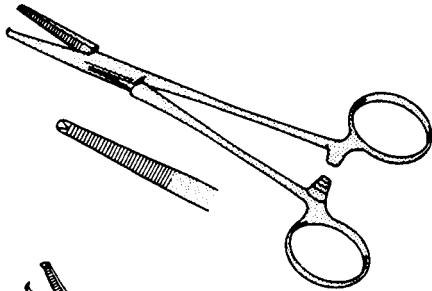
**Kilner**

straight, 1/2 teeth
L1052-14 140mm

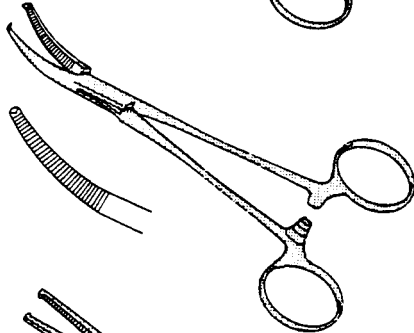
**Kilner**

curved, 1/2 teeth
L1053-14 140mm

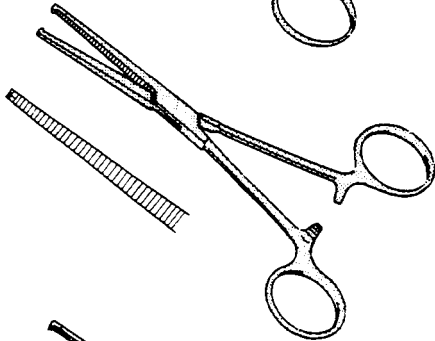
**Kocher**

straight, 1/2 teeth
L1056-12 125mm
L1056-14 140mm
L1056-15 150mm
L1056-18 180mm
L1056-20 200mm
L1056-23 230mm

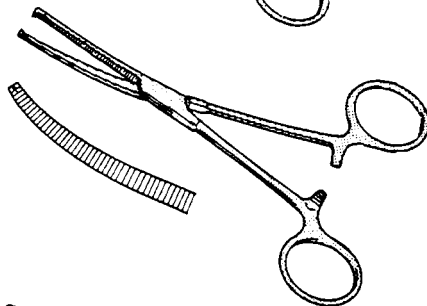
**Kocher**

curved, 1/2 teeth
L1057-12 125mm
L1057-14 140mm
L1057-15 150mm
L1057-18 180mm
L1057-20 200mm
L1057-23 230mm

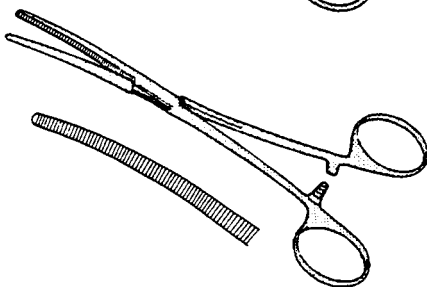
**Mayo**

curved
L1060-15 150mm

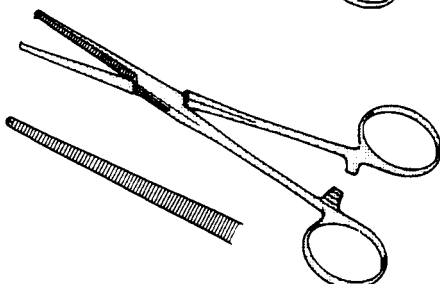
**Mayo Oschner**

straight
L1063-18 185mm

Artery Forceps

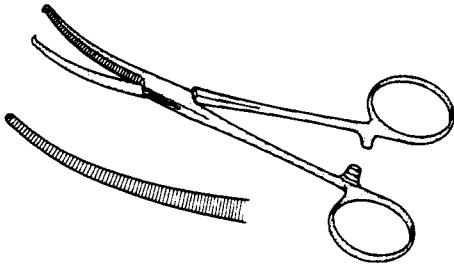
**Mayo Oschner**

curved
L1064-18 185mm

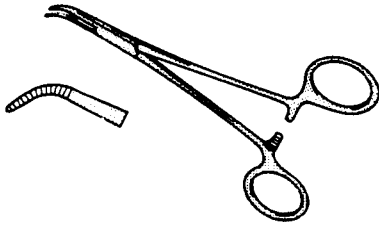
**Mixer Baby**

curved, half serrated jaws
L1069-14 140mm
L1069-18 180mm

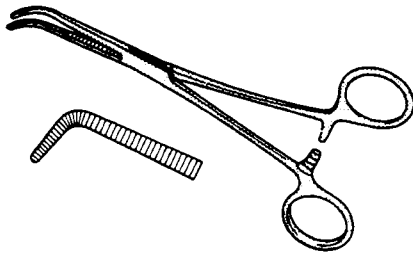
**Mixer**

curved, serrated jaws
L1070-15 150mm
L1070-19 190mm

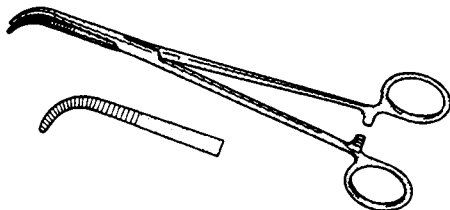
**Mixer**

curved, half serrated jaws
L1070-22 220mm

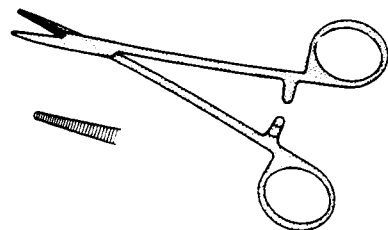
**Mosquito, Halstead**

straight, serrated jaws
L1073-09 90mm, featherweight
L1073-10 95mm
L1073-12 125mm

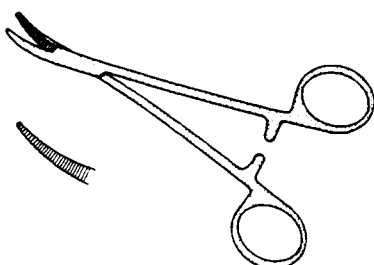
**Mosquito, Halstead**

curved, serrated jaws
L1074-09 90mm, featherweight
L1074-10 95mm
L1074-12 125mm

Artery Forceps

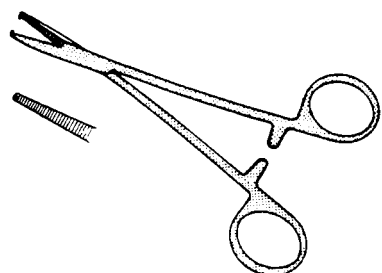
**Mosquito, Halstead**

straight, 1/2 teeth
L1075-12 125mm

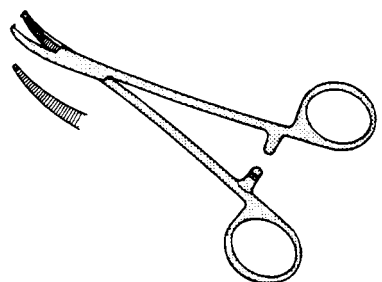
**Mosquito, Halstead**

curved, 1/2 teeth
L1076-12 125mm

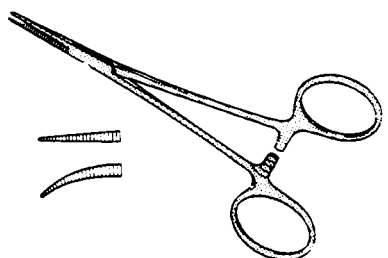
**Mosquito, Micro**

straight
L1078-12 120mm
curved
L1079-12 120mm

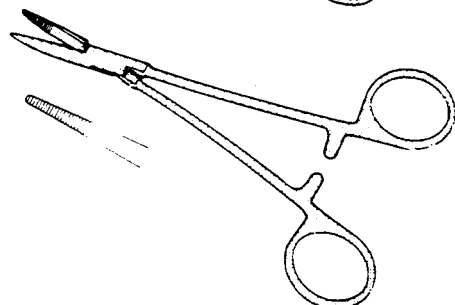
**Moynihan**

straight, half serrated jaws
L1082-14 145mm
L1082-18 180mm

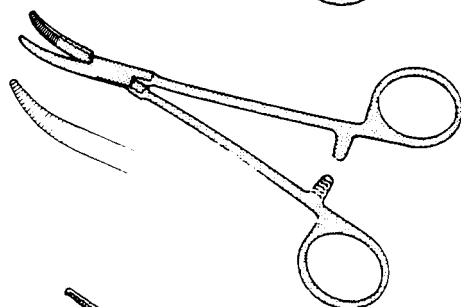
**Moynihan**

curved, half serrated jaws
L1083-14 145mm
L1083-18 180mm

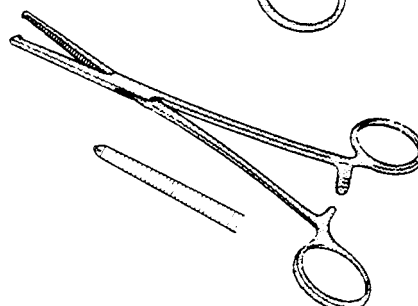
**Oschner**

straight, 1/2 teeth
L1086-14 140mm
L1086-16 165mm
L1086-18 180mm
L1086-20 200mm
L1086-22 220mm
L1086-24 240mm
L1086-26 260mm

Artery Forceps

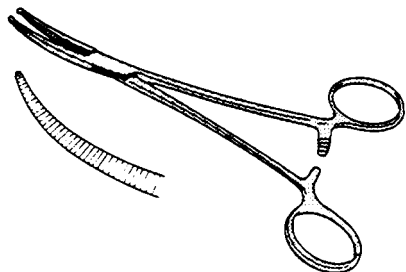
**Oschner**

curved, 1/2 teeth
L1087-14 140mm
L1087-16 165mm
L1087-18 180mm
L1087-20 200mm
L1087-22 220mm
L1087-24 240mm
L1087-26 260mm

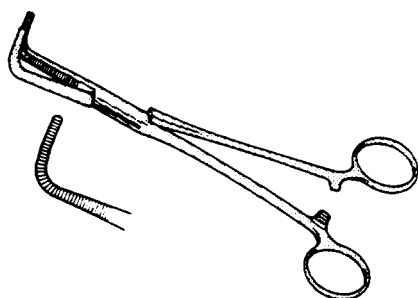
**O'Shaughnessy**

curved
L1090-15 150mm
L1090-18 180mm
L1090-20 200mm

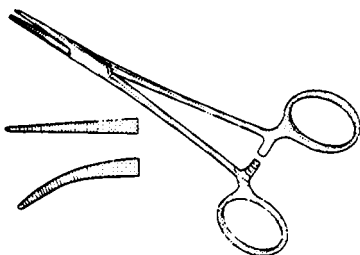
**Providence**

straight
L1093-14 140mm
 curved
L1094-14 140mm

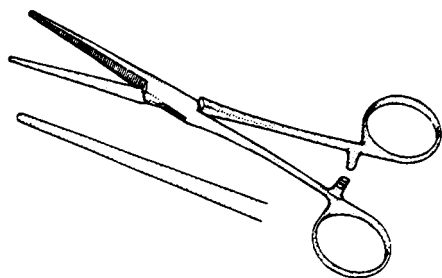
**Rochester-Pean**

straight
L1097-14 140mm
L1097-16 160mm
L1097-18 160mm
L1097-20 200mm
L1097-22 220mm
L1097-24 240mm
L1097-26 260mm
L1097-30 300mm

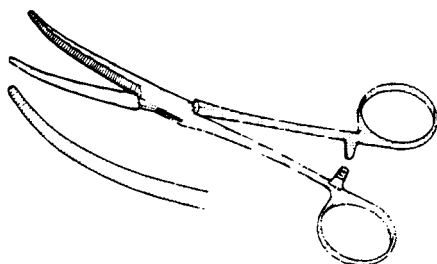
**Rochester-Pean**

curved
L1098-14 140mm
L1098-16 160mm
L1098-18 180mm
L1098-20 200mm
L1098-22 220mm
L1098-24 240mm
L1098-26 260mm
L1098-30 300mm

Artery Forceps

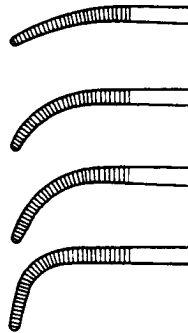
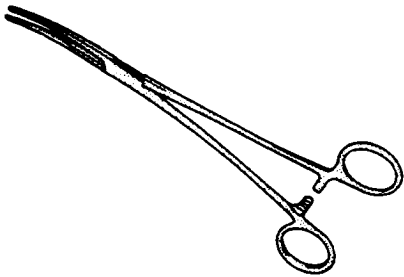
**Rumel**

shallow curve
L1100-23 230mm
 medium curve
L1101-23 230mm
 full curve
L1102-23 230mm
 deep curve
L1103-23 230mm

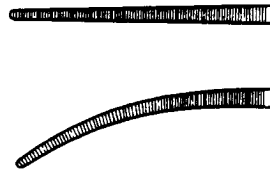
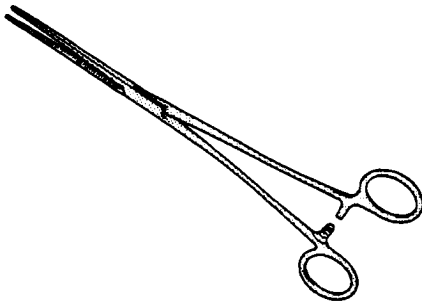
**Sarot**

straight
L1105-24 240mm
 curved
L1106-24 240mm

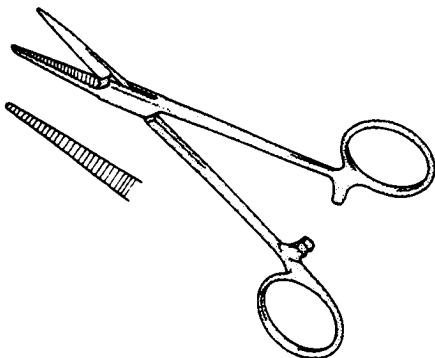
**Spencer-Wells**

straight, serrated jaws
L1108-12 125mm
L1108-15 150mm
L1108-18 180mm
L1108-20 200mm
L1108-23 230mm

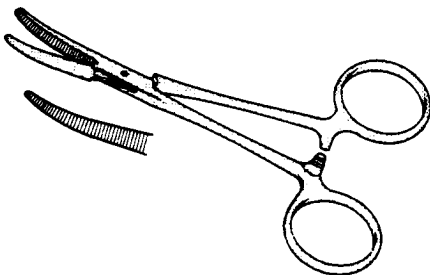
**Spencer-Wells**

curved, serrated jaws
L1109-12 125mm
L1109-15 150mm
L1109-18 180mm
L1109-20 200mm
L1109-23 230mm

Aspirator Set

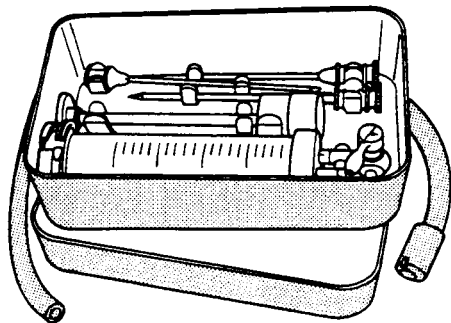
**Martin**

20ml syringe

L1111-20 complete in sterilising case

Bandage

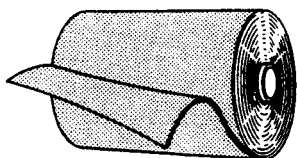
**Esmarch**

red rubber

L1112-27 2.7 metres 75mm

L1112-55 5.5 metres 75mm

Biopsy Needle

Menghini Liver

with stilette, spare blocking pin and trocar for preliminary skin

puncture

child

L1115-02 1.0mm 40mm

L1115-04 1.2mm 40mm

L1115-06 1.4mm 40mm



adult, with adjustable stop

L1115-16 1.9mm 70mm

L1115-18 1.9mm 90mm

L1115-20 1.9mm 100mm

L1115-22 1.9mm 110mm

L1115-24 1.9mm 120mm

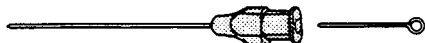

adult

L1115-08 1.0mm 70mm

L1115-10 1.2mm 70mm

L1115-12 1.4mm 70mm

L1115-14 1.6mm 70mm

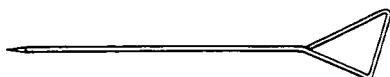
**White (Silverman) Liver and Renal**

with adjusting screw to regulate distance of cutting points beyond

end of needle, range 15mm to 25mm beyond needle effective

length 85mm with adjustable stop

L1118-15 complete

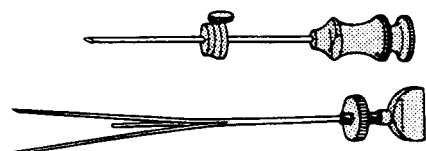

Brush

**Wire**

for cleaning instruments
L1120-28 280mm

Cholecystectomy Forceps

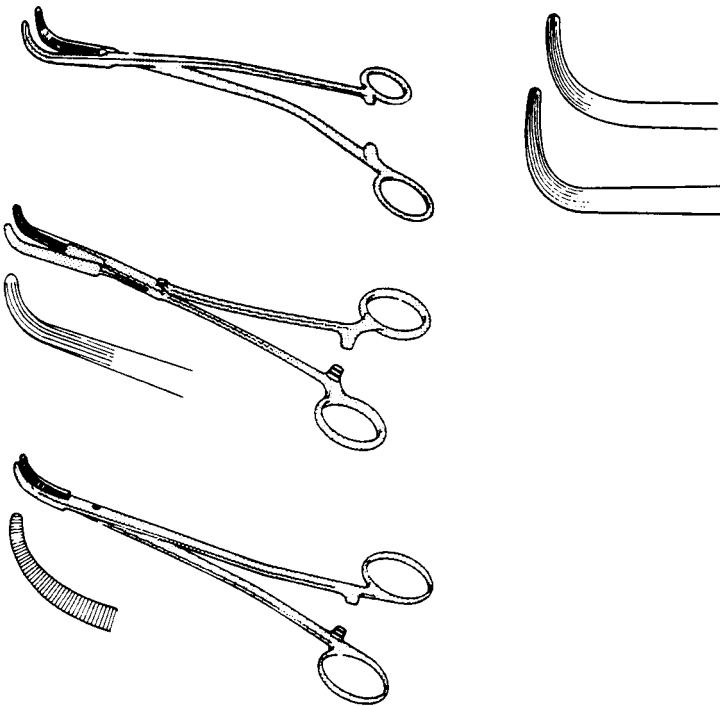
**Geary-Grant**

small, non-toothed jaws,
longitudinal serrations 230mm
L1121-23

large, non-toothed jaws,
longitudinal serrations 230mm
L1121-24

Lahey

curved,
longitudinal serrations
L1124-19 195mm
L1124-23 230mm

Moynihan

curved on flat, box joint
L1127-21 215mm
curved on flat, screw joint
L1128-21 215mm

Clamps

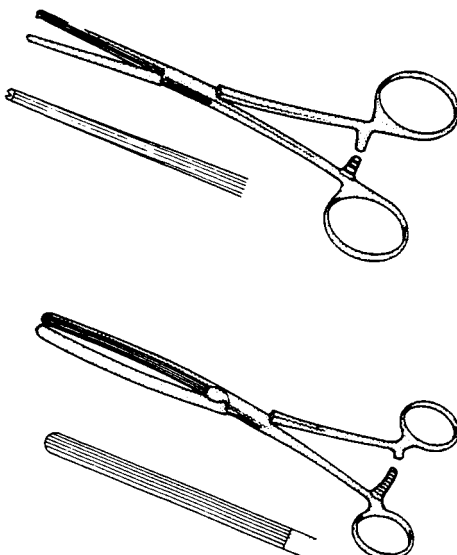
**Allen Intestinal**

L1131-15 155mm

Doyen Intestinal

straight
L1134-18 180mm
L1134-23 230mm

Clamps

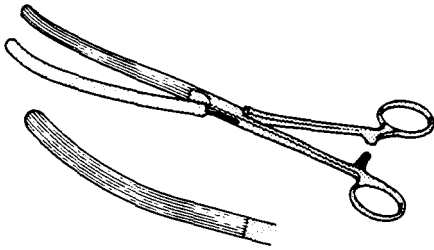
**Doyen Intestinal**

curved
L1135-18 180mm
L1135-23 230mm

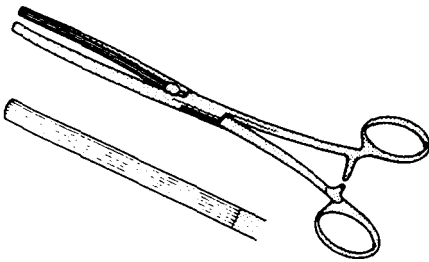
**Kocher Intestinal**

straight, longitudinal serrations, light spring blades
L1141-22 225mm, 100mm blades
L1141-25 250mm, 125mm blades
L1141-27 275mm, 150mm blades
 curved, longitudinal serrations, light spring blades
L1142-22 225mm, 100mm blades
L1142-25 250mm, 125mm blades
L1142-27 275mm, 150mm blades

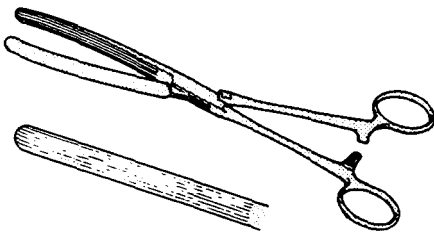
**Lanes Intestinal**

straight, longitudinal serrations
L1145-21 215mm, 75mm blades

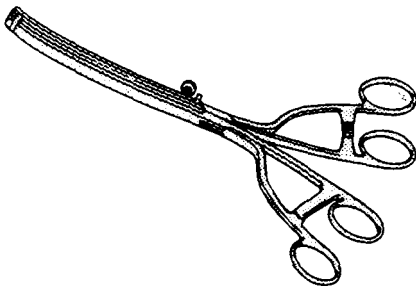
**Lanes Twin**

straight, longitudinal serrations, large
L1148-30 305mm
 curved, longitudinal serrations, large
L1149-30 305mm

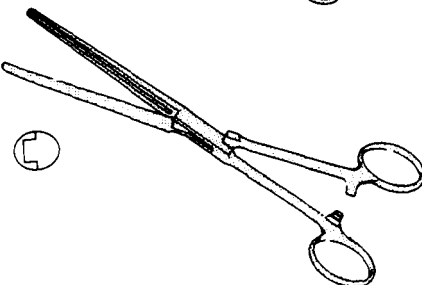
**Lang Stevenson**

keyed blades
L1152-20 200mm, 80mm blades

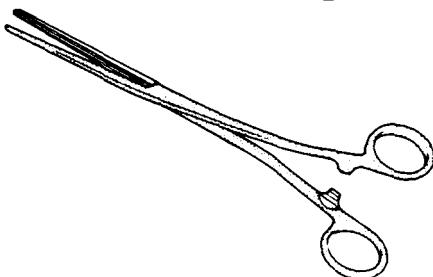
**Parker Kerr**

straight, screw joint
L1155-23 230mm
L1155-25 255mm

Clamps

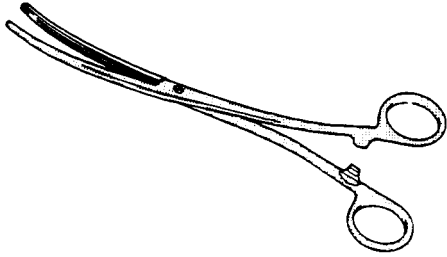
**Parker Kerr**

curved, screw joint

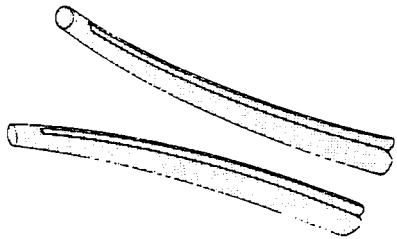
L1156-23 230mm**L1156-25** 255mm**Guard**

for use with Parker Kerr intestinal forceps, 90mm

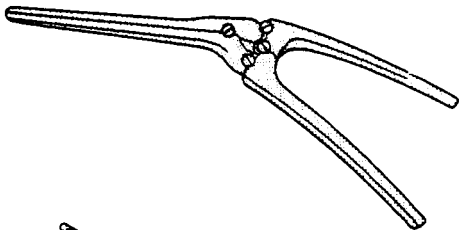
L1157-30 fenestrated on inner curve**L1157-40** fenestrated on outer curve**Payr**

crushing, lever action, longitudinal serrations

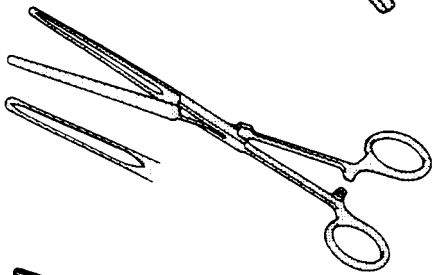
L1159-15 150mm, 50mm blades**L1159-21** 210mm, 65mm blades**L1159-24** 240mm, 100mm blades**L1159-36** 360mm, 150mm blades**Schoemaker-Ogilvie**

straight for hemisphincterectomy, hollow blades

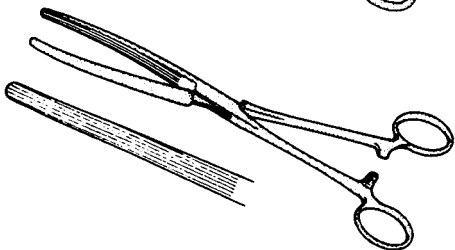
L1162-17 170mm**L1162-21** 215mm**Seton Pringle**

straight, longitudinal serrations, fine blades

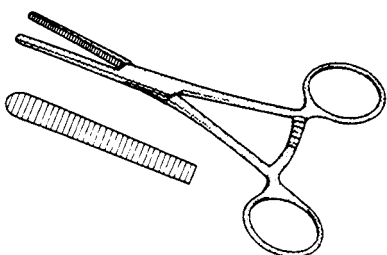
L1165-17 170mm, 2.5mm blade width**Tubing****L1168-14** 145mm

Clamps, Atraumatic

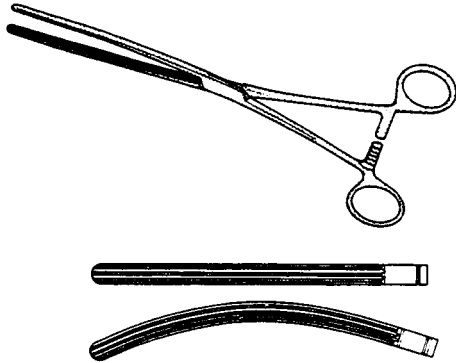
**Doyen**

straight

L1174-13 130mm

L1174-16 160mm

L1174-18 180mm

L1174-21 210mm

L1174-23 230mm

Curved

L1175-13 130mm

L1175-16 160mm

L1175-18 180mm

L1175-21 210mm

L1175-23 230mm

Clip Forceps

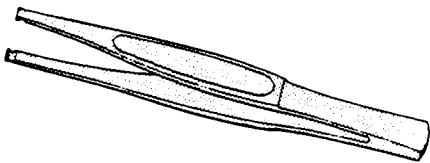
**Comyns Berkeley**

applying, serrated jaws 140mm

L1178-14

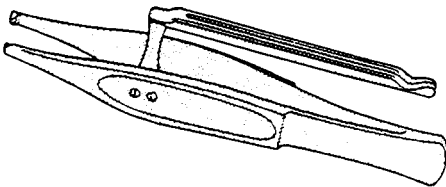
**Comyns Berkeley**

applying, fixed magazine 140mm

L1180-14

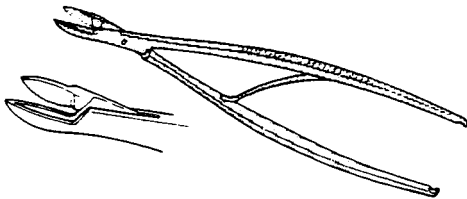
**Michel**

applying and extracting combined 125mm

L1183-12

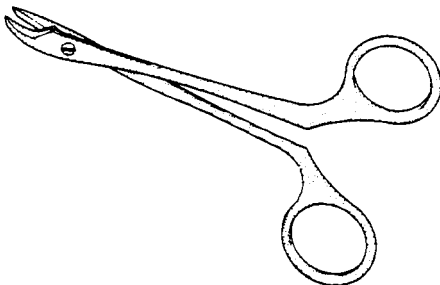
**Michel**

clip extracting 120mm

L1185-12

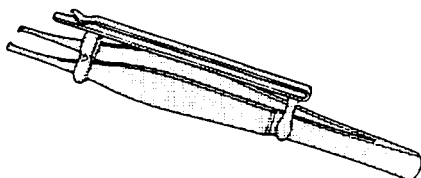
**Michel**

applying, with magazine 125mm

L1187-12

applying 125mm

L1188-12

Decompressor

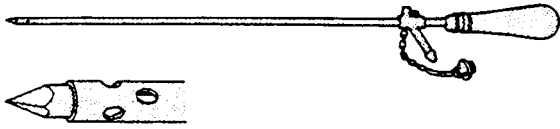
**Savage Intestinal**

trocár and chromium plated cannula
L1190-08 8mm external diameter, 480mm

Depressor

**Sargent Intestinal**

L1192-24 240mm, 40mm wide to 28mm at narrow end
L1192-25 250mm, 65mm wide to 40mm at narrow end

Diagnostic Set

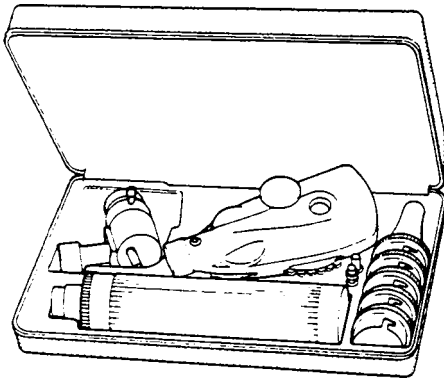
**Combination**

consisting of battery handle, 1 otoscope with 5 ear specula, 1 ophthalmoscope, 2 bulbs complete in case
L1195-30

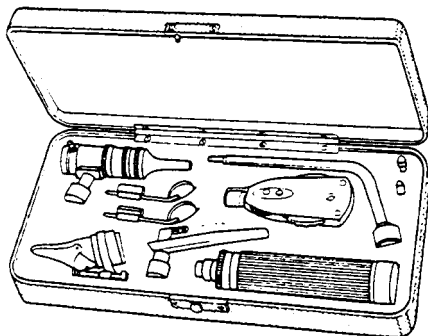
**Universal**

consisting of battery handle, 1 otoscope with 3 ear specula, 1 ophthalmoscope, 1 nasal speculum, 2 laryngeal mirrors with holder, 1 tongue depressor holder, 2 bulbs complete in case
L1195-35

Diathermy

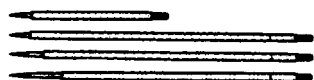
**Bristol Handle**

L1198-12 to hold Bristol points

Bristol Points

L1201-24 25mm long, 4mm tip

L1201-54 55mm long, 4mm tip

L1201-57 55mm long, 7mm tip

L1201-59 55mm long, 11 mm tip

**Cable**

red rubber covered

L1204-25 2.5 metres

L1204-45 4.5metres

**Carrier**

for ball and plate electrodes

L1207-10 straight

**Carrier**

for ball and plate electrodes

L1208-15 curved

**Electrode**

cervical biopsy, screw fitting, to fit handles 1198/05 and 1216/05

L1211-16 small

L1211-18 medium

L1211-20 large

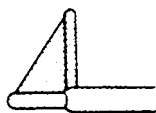
**Electrode**

cervical biopsy, screw fitting, to fit handles 1198/05 and 1216/05

L1212-16 small

L1212-18 medium

L1211-20 large

**Electrode**

ball, silver

L1213-05 5mm

L1213-08 8mm

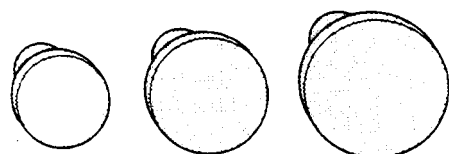
**Electrode**

plate, silver

L1213-09 8mm

L1213-10 10mm

L1213-12 12mm

Diathermy

**Handle**

for knife electrode and electrode carrier
L1215-10

**Handle**

for loops and needles
L1216-10

**Knife**

Monel metal blade 50mm
L1219-50

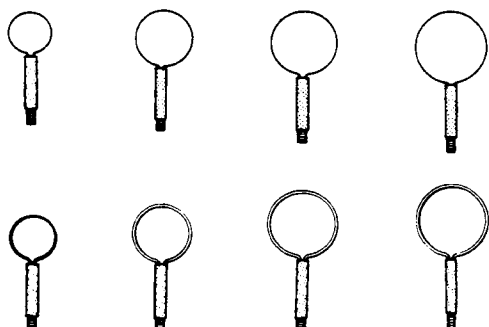
**Loops**

fine (30swg)
L1222-08 8mm
L1222-10 10mm
L1222-12 12mm
L1222-14 14mm
stout (25swg)
L1223-08 8mm
L1223-10 10mm
L1223-12 12mm
L1223-14 14mm

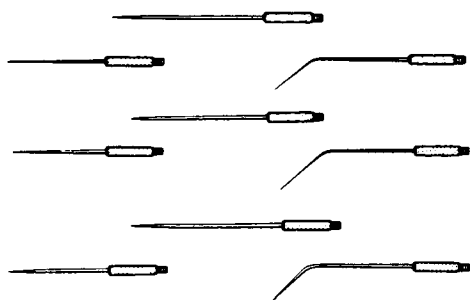
**Needles**

fine (25swg)
L1226-20 short 20mm
L1226-32 long 32mm
L1226-35 angled 30mm
medium (22swg)
L1227-20 short 20mm
L1227-32 long 32mm
L1227-35 angled 30mm
stout (19swg)
L1228-20 short 20mm
L1228-32 long 32mm
L1228-35 angled 30mm

Diathermy

**Quiver**

plastic with ring 200mm 65mm
L1231-20

**Turner-Warwick Scalpel**

No. 3
L1234-30
No. 4
L1234-40

Diathermy Forceps

**Adson**

Serrated
L1237-12 125mm
L1237-18 180mm

**Adson**

1/2 teeth
L1238-12 125mm
L1238-18 180mm

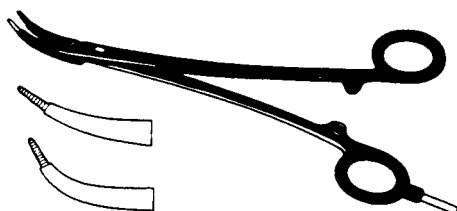
**Crosbie Ross**

shallow curve, screw joint
L1241-23 230mm
deep curve, screw joint
L1241-25 230mm

**Dissecting**

Serrated
L1244-10 100mm
L1244-15 150mm
L1244-18 180mm
L1244-20 200mm
L1244-24 240mm

**Dissecting**

1/2 teeth
L1247-10 100mm
L1247-15 150mm
L1247-18 180mm
L1247-20 200mm
L1247-24 240mm

Diathermy Forceps

**Gillies**

1/2 teeth
L1250-15 150mm

**McIndoe**

serrated
L1253-15 150mm

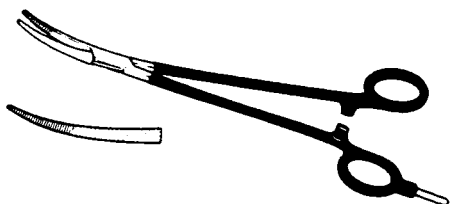
**Riches**

curved on flat, box joint
L1256-14 145mm
L1256-20 200mm

**Riches**

curved on flat, screw joint
L1257-12 125mm
L1257-15 150mm
L1257-18 180mm
L1257-20 200mm
L1257-23 230mm

**Waugh**

serrated
L1260-18 180mm
L1260-20 200mm

**Waugh**

1/2 teeth
L1261-18 180mm
L1261-20 200mm

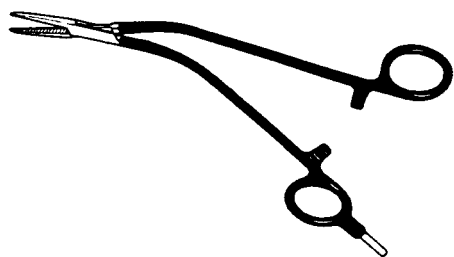
**Wilfred Adams**

serrated
L1264-20 200mm

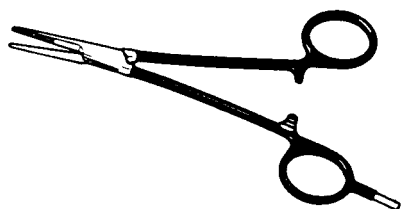
**Wilson Hay**

straight
L1267-14 145mm
L1267-18 180mm
L1267-23 230mm

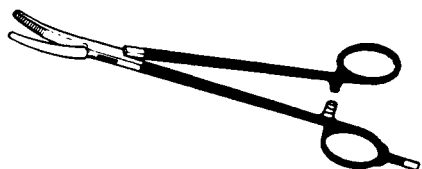
**Wilson Hay**

curved
L1268-14 145mm
L1268-18 180mm
L1268-23 230mm

Diathermy Scissors

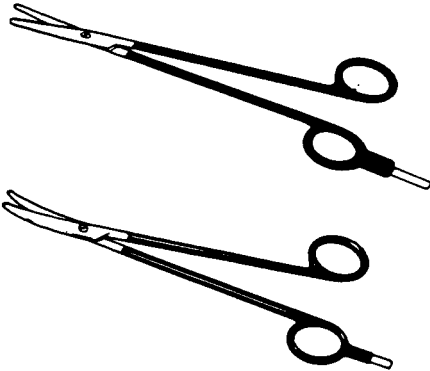
**Turner-Warwick**

straight

L1271-18 180mm

L1271-21 215mm

L1271-24 240mm

Turner-Warwick

curved

L1272-18 180mm

L1272-21 215mm

L1272-24 240mm

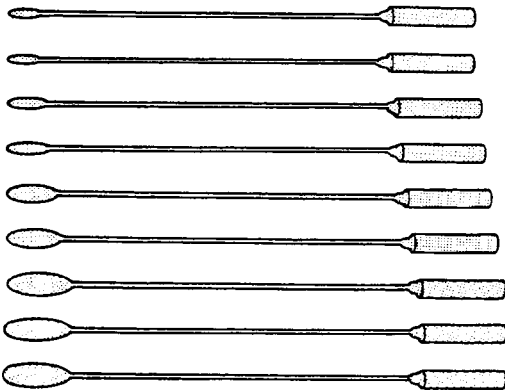
**Bake Bile Duct**

malleable stems 200mm

L1275-03 3mm diameter head

L1275-04 4mm diameter head

L1275-05 5mm diameter head

L1275-06 6mm diameter head

L1275-07 7mm diameter head

L1275-08 8mm diameter head

L1275-09 9mm diameter head

L1275-10 10mm diameter head

L1275-11 11 mm diameter head

L1275-90 set of 9

Directors

**Brodie**

probe-ended, malleable

L1278-14 140mm

L1278-16 165mm

L1278-20 200mm

Dissecting Forceps

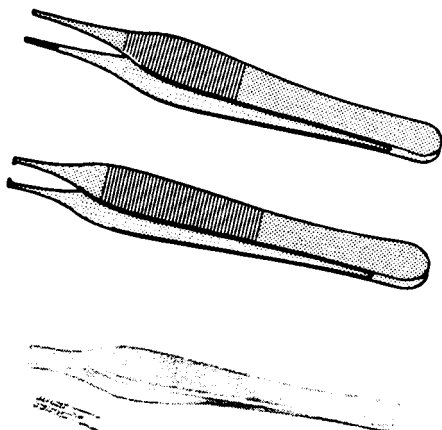
**Adson**

serrated

L1281-12 125mm

serrated, fine

L1281-13 125mm

Adson

112teeth

L1282-12 125mm

112 teeth, fine

L1282-13 125mm

Adson-Brown

L4137-12 12cm

L4137-15 15cm

Dissecting Forceps

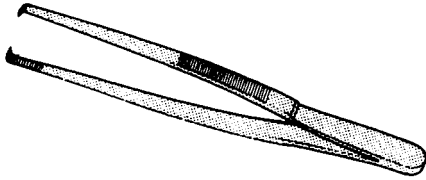
**Block End**

1/2 teeth, narrow flutes
L1285-15 150mm
L1285-18 180mm

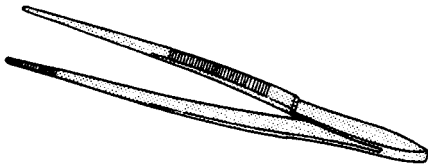
**Block End**

round serrated jaws, narrow flutes
L1292-15 150mm
L1292-18 180mm
L1292-20 200mm
L1292-25 250mm

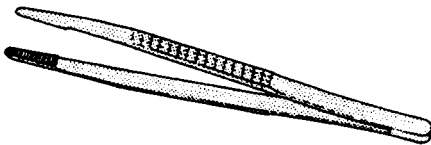
**Bonney**

serrated
L1301-18 180mm

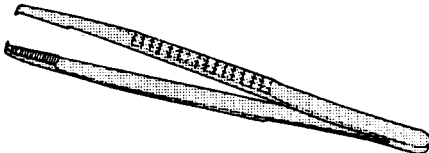
**Bonney**

1/2 teeth
L1301-18 180mm

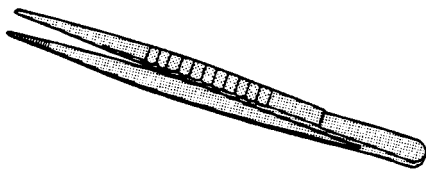
**Canadian**

serrated jaws
L1304-14 140mm
L1304-15 150mm

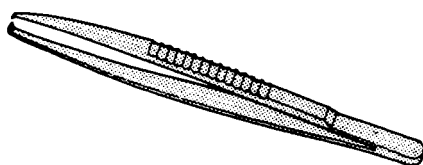
**Canadian**

2/3 teeth
L1305-14 140mm
L1305-15 150mm

Dissecting Forceps

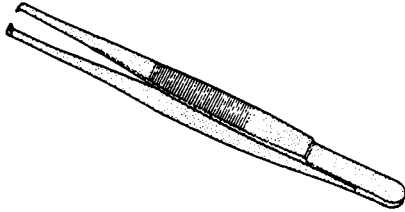

Continental Pattern

1/2 teeth	
L1308-10	105mm
L1308-11	115mm
L7308-12	125mm
L1308-14	145mm
L1308-15	150mm
L1308-16	160mm
L1308-17	175mm
L1308-20	200mm
L1308-25	250mm
L1308-30	300mm



Continental Pattern

2/3 teeth	
L1310-12	125mm
L1310-14	145mm
L1310-16	160mm
L1310-17	175mm
L1310-20	200mm
L1310-25	250mm
L1310-30	300mm



Continental Pattern

1/2 teeth, narrow	
L1309-12	125mm
L1309-14	145mm
L1309-16	160mm
L1309-17	175mm



Continental Pattern

3/4 teeth	
L1311-12	125mm
L1311-14	145mm
L1311-16	160mm



Continental Pattern

4/5 teeth	
L1312-12	125mm
L1312-14	145mm
L1312-20	200mm

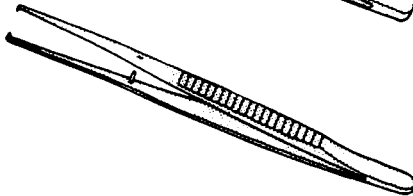
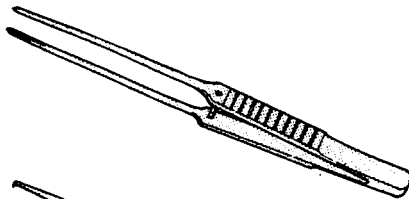

Emmett

serrated jaws	
L1315-20	200mm

Gillies

1/2 teeth	
L1318-15	150mm

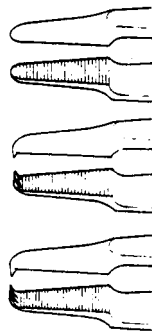
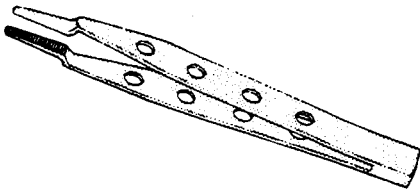

Jeans

serrated jaws	
L1321-14	140mm
1/2 teeth	
L1322-14	140mm
L1322-18	180mm
2/3 teeth	
L1323-18	180mm

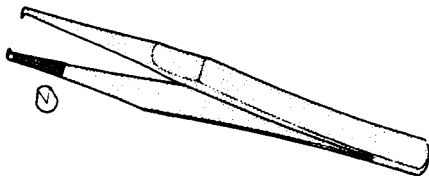

Lanes

1/2 teeth	
L1326-12	125mm
L1326-14	140mm
L1326-18	180mm
L1326-20	200mm

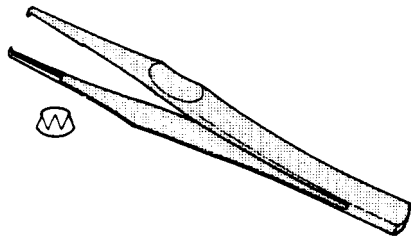

Dissecting Forceps

**Lanes**

2/3 teeth

L1327-12 125mm

L1327-14 140mm

L1327-18 180mm

L1327-20 200mm

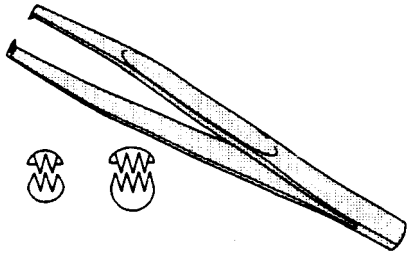
**Leedham Green**

L1329-14 2/3 teeth, 145mm

L1329-15 3/4 teeth, 145mm

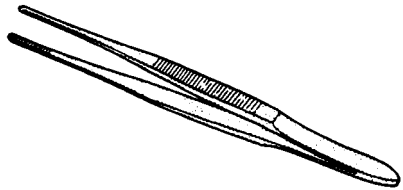
**Leeds**

serrated

L1330-15 150mm

L1330-17 170mm

L1330-20 200mm

L1330-25 250mm

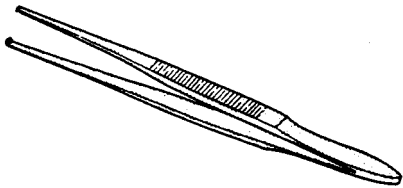
**Leeds**

112 teeth

L1331-15 150mm

L1331-17 170mm

L1331-20 200mm

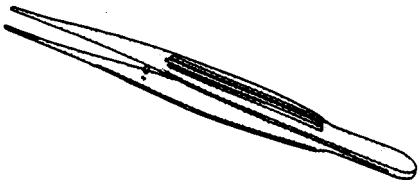
**McIndoe**

serrated

L1334-15 150mm

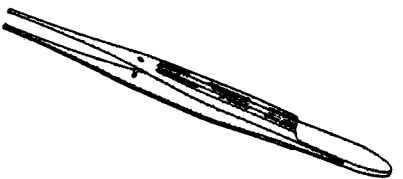
**McIndoe**

1/2 teeth

L1334-16 150mm

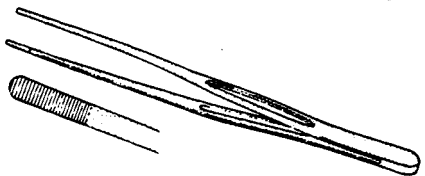
**Maingot**

straight, serrated tips, fenestrated grip

L1337-28 280mm

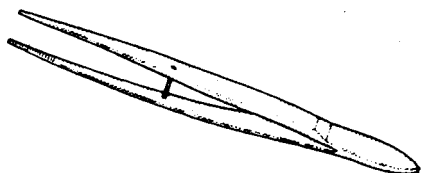
**Pake**

straight, fine serrated jaws

L1340-11 115mm

Dissecting Forceps

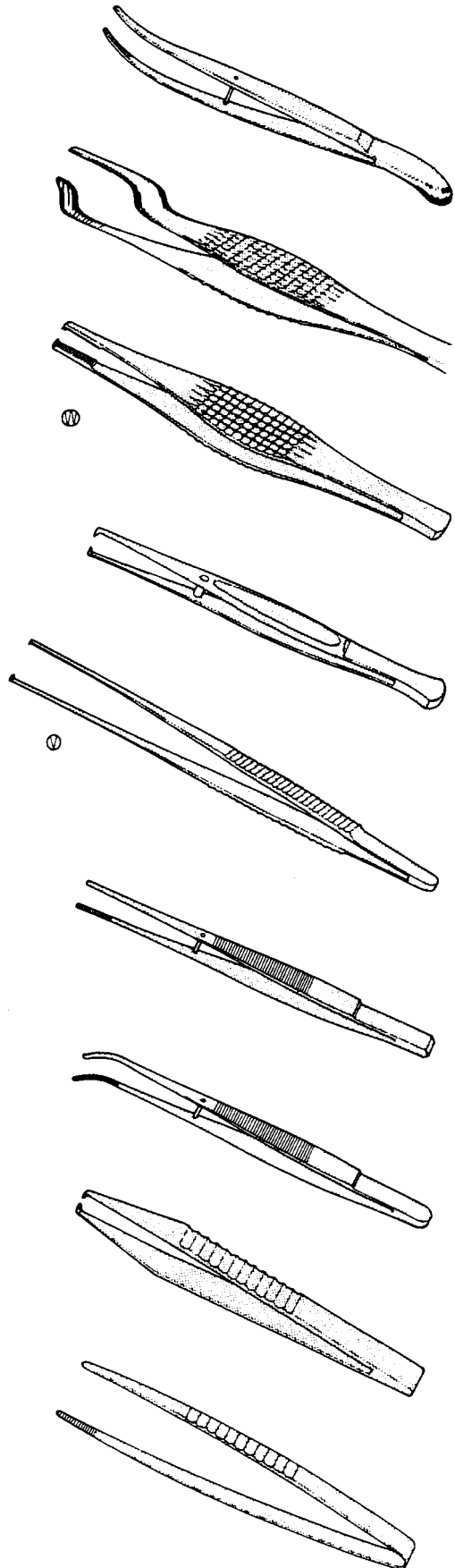
**Pake**

curved, fine serrated jaws
L1341-11 115mm

Ramsey

serrated
L1344-18 180mm

Ramsey

1/2 teeth
L1345-18 180mm
 2/3 teeth
L1346-18 180mm

Rat Tooth

1/2 teeth
L1349-12 125mm

St Marks Hospital

serrated
L1352-29 290mm
 1/2 teeth
L1353-29 290mm

Taylor

straight
L1356-18 180mm

Taylor

curved
L1357-18 180mm

Treves

1/2 teeth
L1360-12 125mm
L1360-15 150mm
L1360-18 180mm
L1360-20 200mm
L1360-25 250mm

Turn-Over-End

serrated jaws, broad flutes
L1363-12 125mm
L1363-15 150mm
L1363-18 180mm

Dissecting Forceps

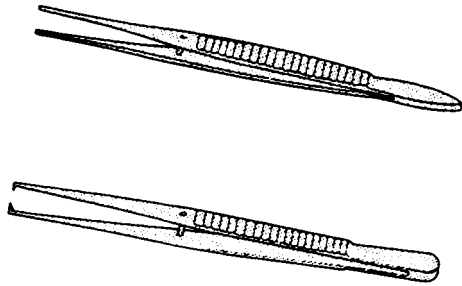

Waugh
serrated jaws
L1366-15 150mm
L1366-20 200mm

Waugh
1/2 teeth
L1367-15 150mm
L1367-20 200mm

Dissecting Forceps, Tungsten Carbide

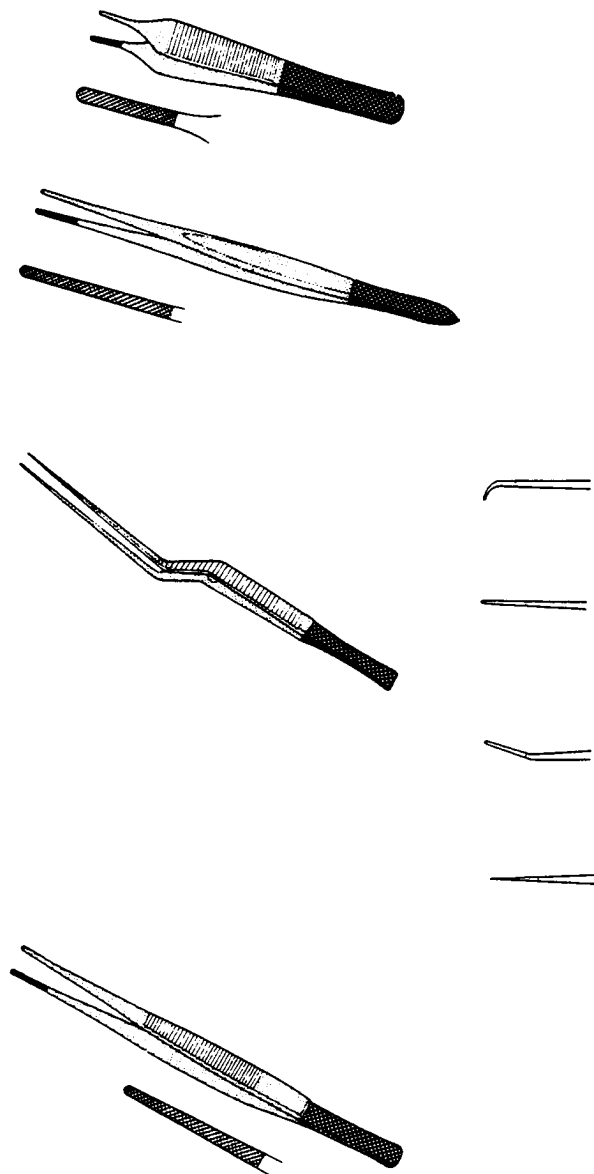

Adson
L1370-12 120mm
Cushing
L1373-1\$ 180mm

Micro
angled
L1375-18 185mm
L1375-21 210mm

straight, blunt
L1377-18 185mm
L1377-21 210mm

curved
L1378-18 185mm
L1378-21 210mm

straight, fine
L1376-18 185mm
L1376-21 210mm

Potts-Smith
L1381-15 150mm
L1381-18 180mm
L1381-20 200mm
L1381-23 230mm
L1381-25 250mm



Dissectors

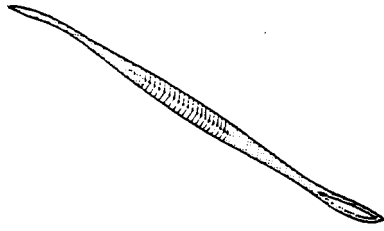

Durham
double ended
L1382-19 190mm

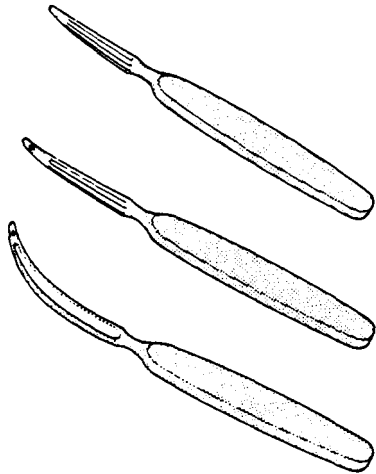

Kocher Thyroid
curved
L1385-16 160mm
L1385-17 165mm
L1385-18 180mm

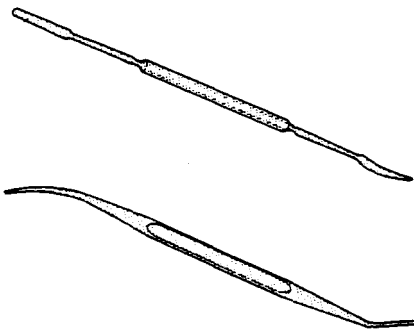

MacDonald
double ended
L1388-19 190mm

Watson Cheyne
fine with probe
L1391-12 125mm
L1391-18 180mm

Dressing Forceps

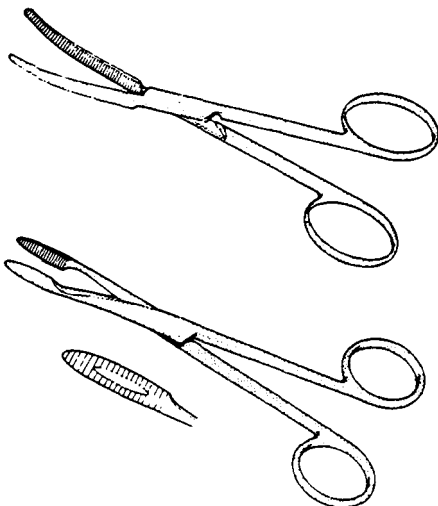

Bryant
Serrated jaws, screw joint
L1394-12 125mm
serrated jaws, box joint
L1395-12 125mm

French Bow
screw joint
L1398-12 125mm

Dressing Forceps

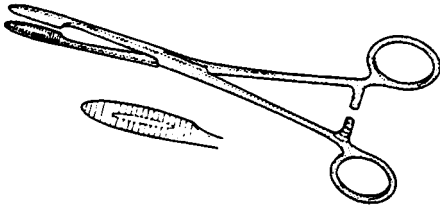
**Gross-Maier**

straight

L1401-20 200mm

L1401-25 250mm

curved

L1402-20 200mm

L1402-25 250mm

Duodenal Forceps

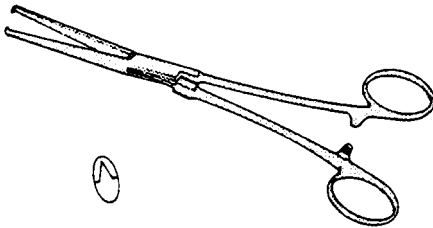
**Pannett**

straight, blades 64mm with longitudinal serrations and 1/2 teeth

L1405-20 200mm

Dynamometer

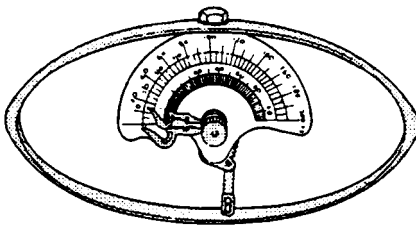
**Collin**

L1408-15 for adult

L1408-20 for children

Epidural Needle

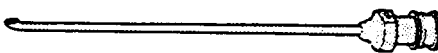
**Tuohy**

curved trocar, pointed end, luer fitting

L1411-90 90mm

Gallstone Forceps

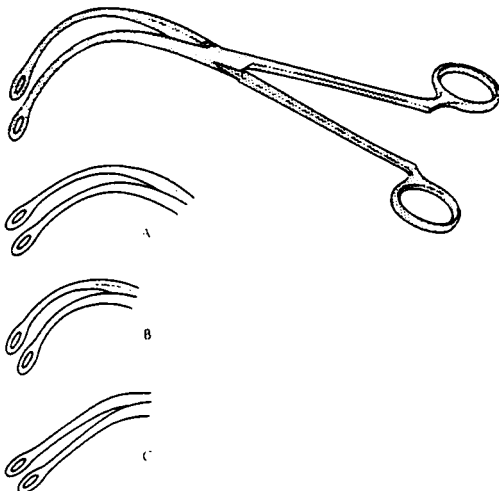
**Blackburn**

shape A

L1414-18 185mm

shape B

L1414-20 200mm

shape C

L1414-21 210mm

Gallstone Forceps

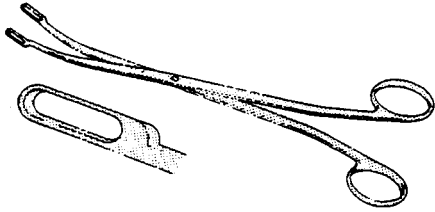
**Desjardins**

screw joint

L1417-22 small, 220mm**L1417-24** large, 240mm

box joint

L1418-22 small, 220mm**L1418-24** large, 240mm

Goniometer

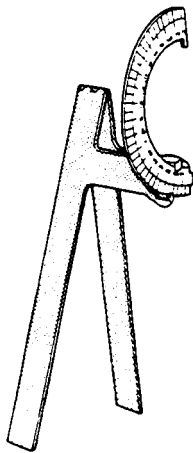
**Moltgen****L1421-10** for measuring joint movement

Head Lamps

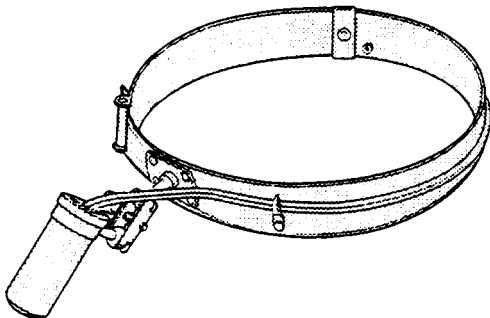
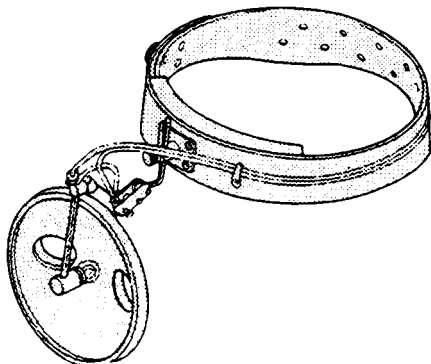
**Adjustable Focus****L1424-10** with plastic headband**Clar****L1426-10** with plastic headband

Head Mirror

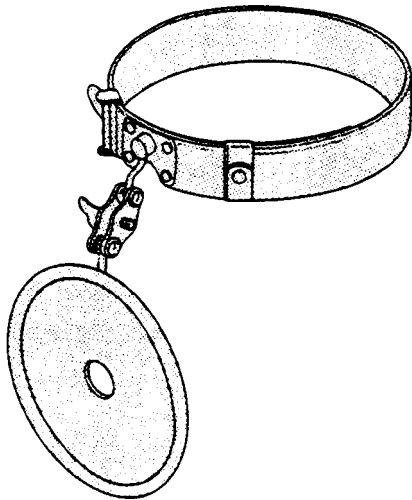

Ziegler
with plastic head band
L1430-90 90mm
L1430-10 100mm

Hernia Forceps

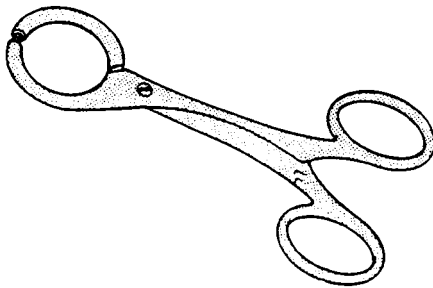

Collingwood Stewart
ring bladed, screw joint
L1433-14 140mm

Instrument Pins

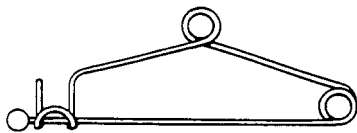

Mayo
with ball end
L1437-10 100mm
L1437-15 150mm

Intestinal Forceps



Denis Brown
L1439-19 190mm

Introducing Forceps

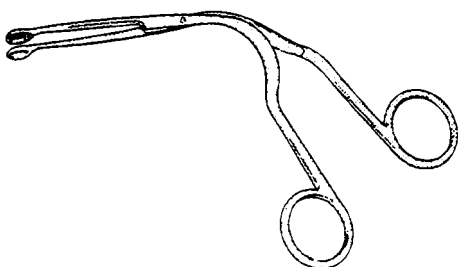

Magill
screw joint
L1440-23 adult, 230mm
L1440-19 child, 190mm
L1440-17 infant, 17mm

Knives

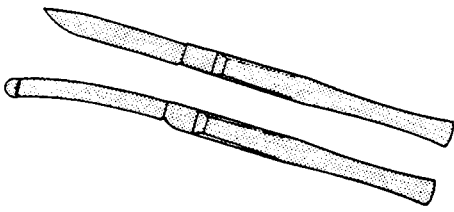
**Bistouries**

L7443-12 straight, sharp
 L1443-14 curved, sharp
 L1443-16 straight, probe
 L1443-18 curved, probe
 L1443-20 hernia

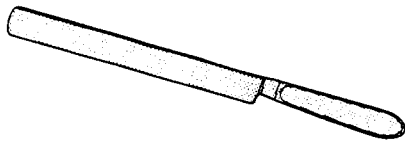
**Brain**

solid forged
 L1445-20 200mm blade
 L1445-22 225mm blade
 L1445-25 250mm blade
 L1445-30 300mm blade

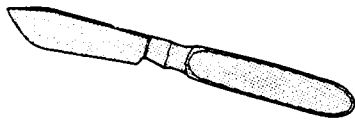
**Cartilage**

solid forged
 L1448-70 200mm, 70mm blade
 L1448-90 215mm, 90mm blade

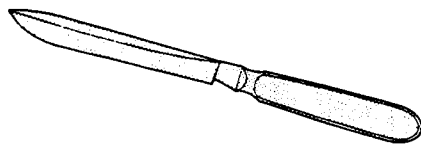
**Catlin**

solid forged
 L1451-12 245mm, 120mm blade

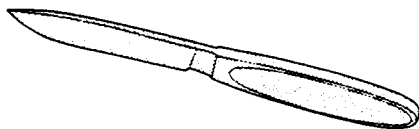
**Liston Amputation**

solid forged
 L1454-10 100mm blade
 L1454-12 125mm blade
 L1454-15 150mm blade
 L1454-18 180mm blade

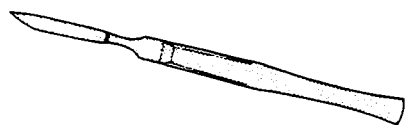
**Paget**

L145-14 140mm

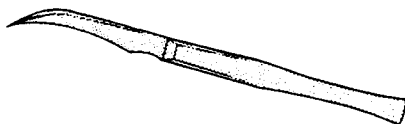
**Symes Abscess**

L1456-14 140mm
 Laryngoscopes

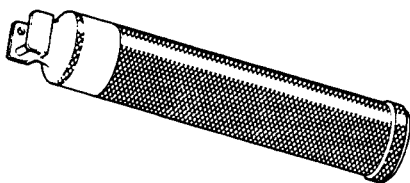
**Handle**

L1457-15 150mm

Laryngoscopes

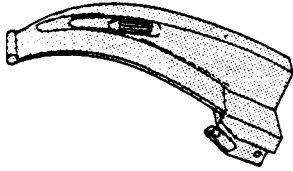
**Macintosh**

blade, curved, hook end

L1460-09 infant, 90mm

L1460-11 child, 112mm

L1460-13 adult, 130mm

L1460-15 adult, large, 150mm

L1460-40 complete with 4 blades and har

Ligature Conductors

**Brunner**

300mm

L1461-30 straight

L1461-35 left

L1461-40 right

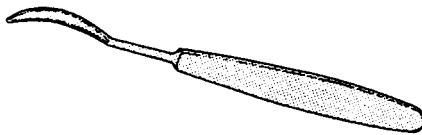
**Schmieden**

L1462-19 190mm

Light Sources

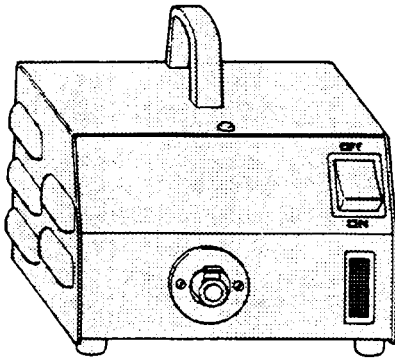
**Single Port**

240 volts 50-60hz

L1466-12 12 volt, 55 watt lamp

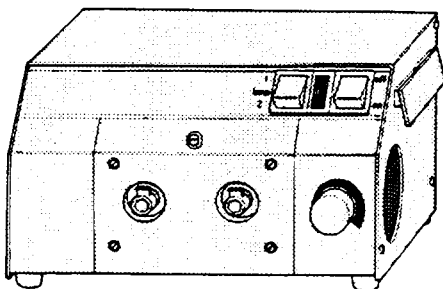
**Double Port**

240 volts 50-60hz

L1467-15 15 volt, 150 watt lamp

Light Sources

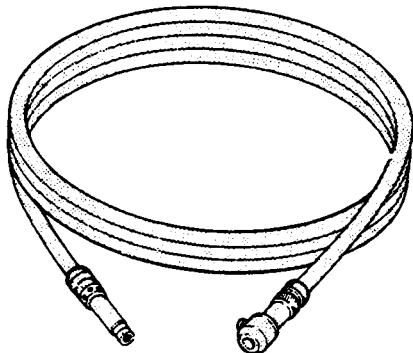
**Fibre Light Cable**

Fully autoclavable, all fittings available

L1470-20 2mm diameter 1.8 metres length**L1470-35** 3.5mm diameter 1.8 metres length

Measures

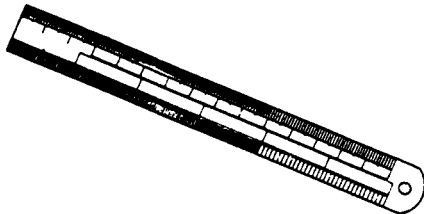
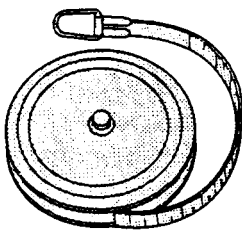
**Steel Rule****L1473-15** 150mm**L1473-30** 300mm**Tape**

oil cloth

L1475-20 2 metres

steel

L1477-20 2 metres

Mouth Gags

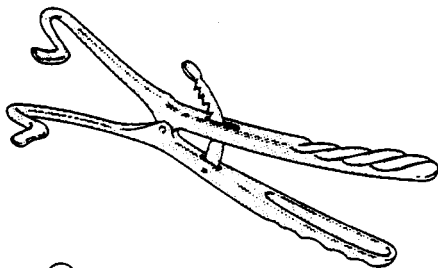
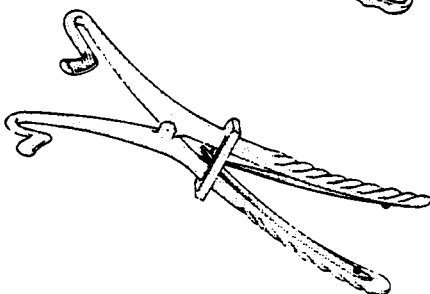
**Ackland****L1480-20** adult, 200mm**L1480-17** child, 170mm**Ferguson**

Ackland law

L1482-20 adult, 200mm**L1482-17** child, 170mm

ordinary jaw

L1483-20 adult, 200mm**L1483-17** child, 170mm

Mouth Gags

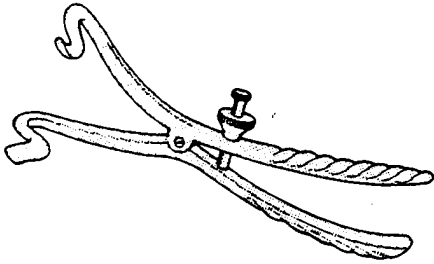
**Mason**

Ackland jaw

L1485-20 adult, 200mm

L1485-17 child, 170mm

Needleholders

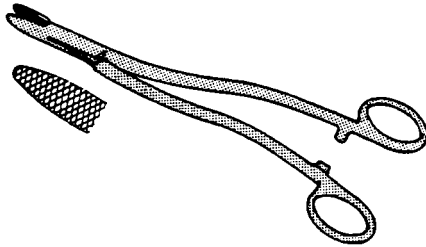
**Bozemann**

double curve, serrated jaws

L1490-20 200mm

L1490-23 230mm

L1490-25 255mm

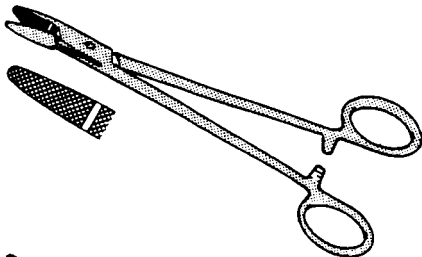
**Crile-Murray**

serrated jaws

L1493-14 145mm

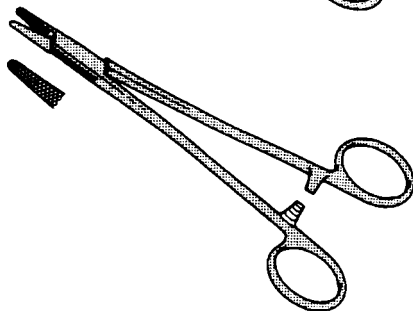
**Crile Wood**

serrated jaws

L1496-15 150mm

L1496-18 180mm

L1496-20 200mm

L1496-23 230mm

L1496-25 255mm

L1496-31 305mm

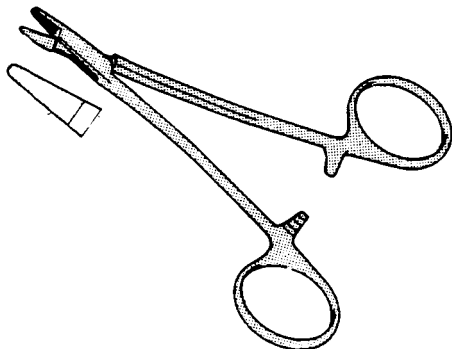
**Derf**

serrated jaws

L1497-12 120mm

Needleholders

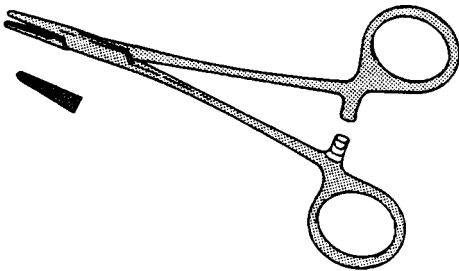

Halsey
serrated jaws
L1499-12 125mm

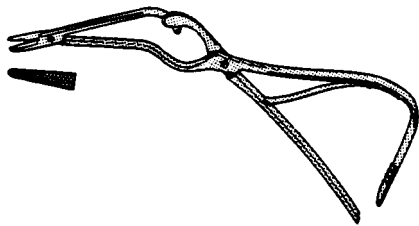

Halstead
screw joint, serrated jaws
L1502-21 215mm

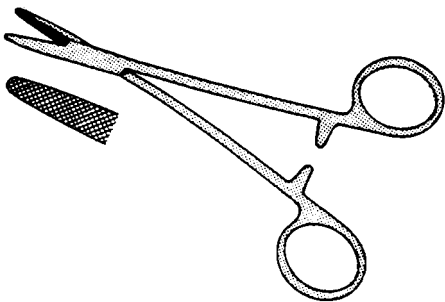

Hegar
serrated jaws
L1505-20 200mm

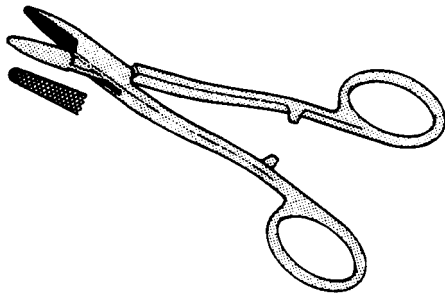

Kilner
serrated jaws
L1508-13 135mm
L1508-16 165mm

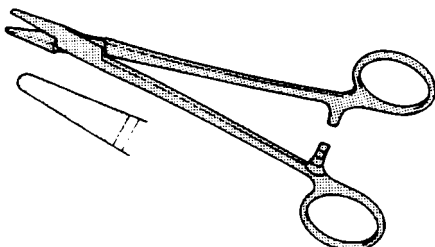

Lawrance
lightweight, serrated jaws
L1511-15 150mm

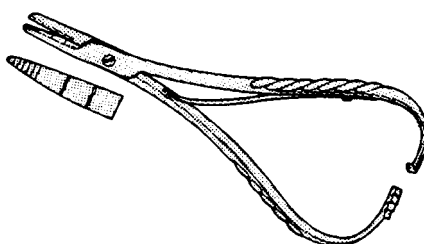

Macphail
screw joint with copper jaws
L1514-15 150mm
L1514-18 180mm
L1514-20 200mm

Needleholders

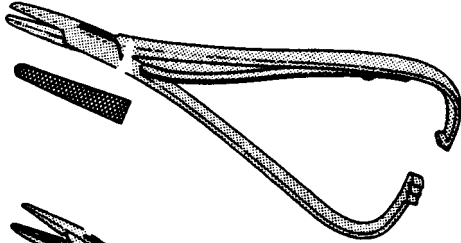
**Mathieu**

serrated jaws
L1517-17 170mm
L1517-20 200mm

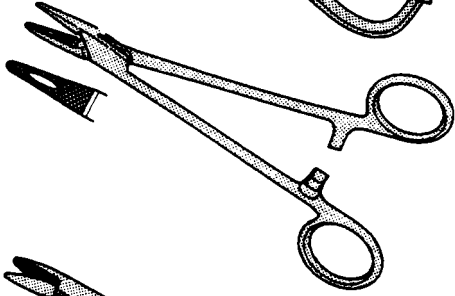
**Mayo**

light pattern, serrated jaws
L1520-15 150mm

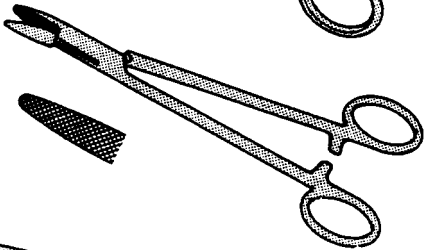
**Mayo**

wide serrated jaws
L1521-12 125mm **L1521-19** 190mm
L1521-14 140mm **L1521-20** 200mm
L1521-15 150mm **L1521-23** 230mm
L1521-16 165mm **L1521-25** 255mm
L1521-18 180mm **L1521-30** 305mm

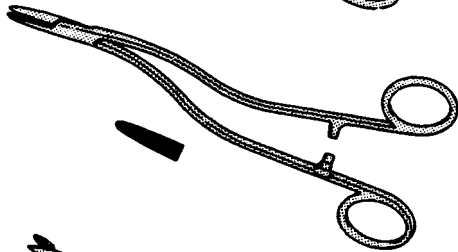
**Mogg**

Serrated jaws
L1524-20 200mm

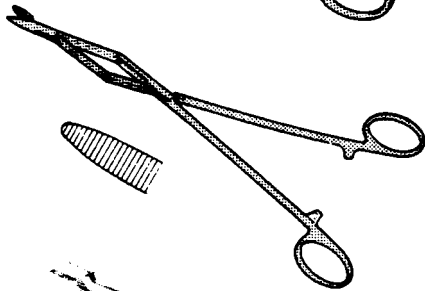
**Naunton Morgan**

compound action, serrated jaws
L1527-18 185mm
L1527-25 250mm

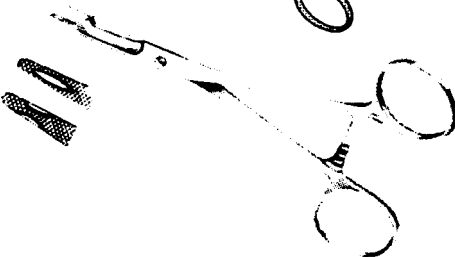
**Olsen-Hegar**

L6030-14 14cm
L6030-18 18cm

**Olsen-Hegar**

L6030-17 17cm

Needleholders



Olsen-Hegar
L6031-14 14cm

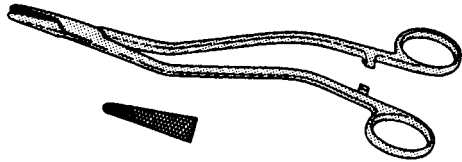

Thompson-Walker
serrated jaws
L1530-20 200mm

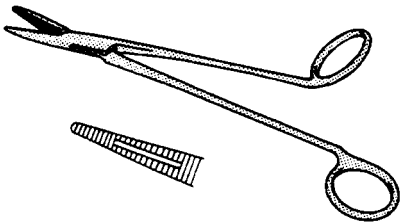

Ward
serrated, fenestrated jaws
L1535-18 180mm

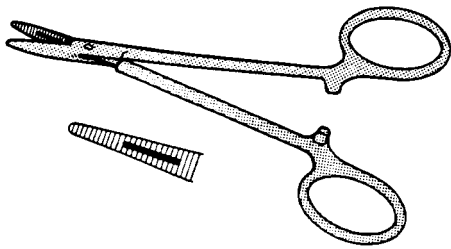

Wright
grooved serrated jaws
L1538-14 140mm

Needleholders, Tungsten Carbide

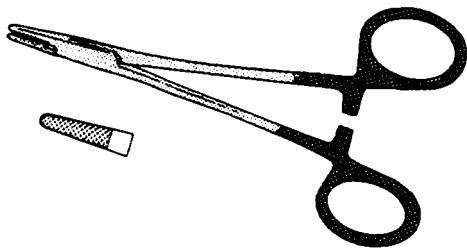

Baumgartner
L1545-12 125mm
L1545-14 140mm

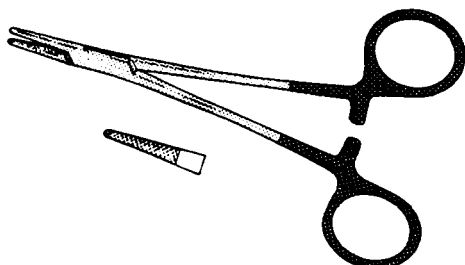

Converse
L1548-12 125mm

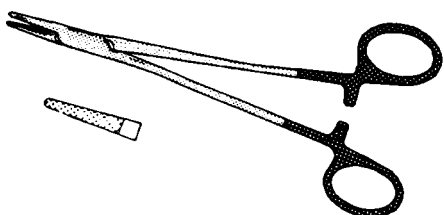

Crile Wood
L1551-15 150mm
L1551-18 180mm
L1551-20 200mm
L1551-23 230mm
L1551-25 255mm
L1551-30 305mm

Needleholders, Tungsten Carbide

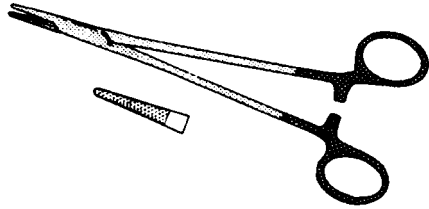
**DeBakey**

L1554-18	180mm
L1554-20	200mm
L1554-23	230mm
L1554-25	250mm
L1554-30	305mm

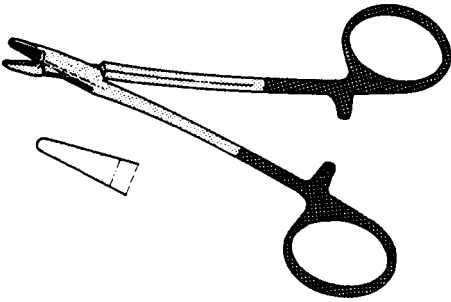
**Derf**

L1556-12	120mm
----------	-------

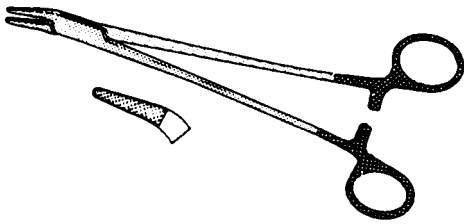
**Finochietto**

L1557-20	200mm
L1557-26	265mm

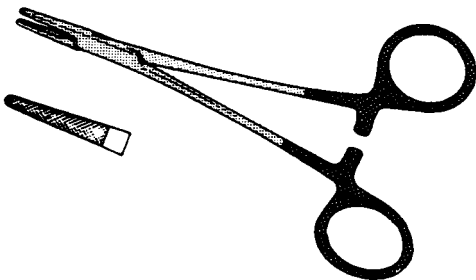
**Halsey**

L1559-12	125mm
----------	-------

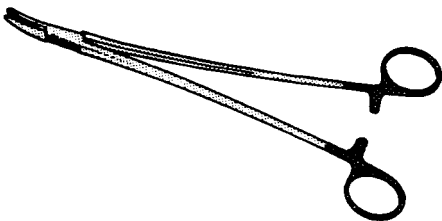
**Heaney**

curved	
L1560-20	200mm
L1560-25	250mm

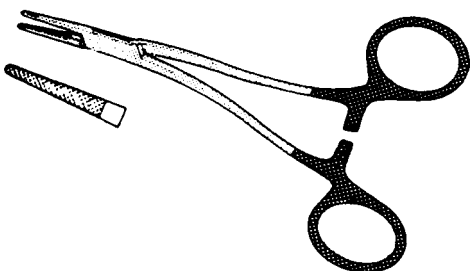
**Kilner**

L1561-13	135mm
L1561-16	165mm

Needleholders, Tungsten Carbide

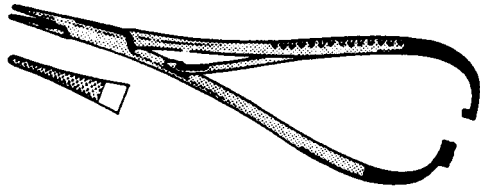

Kocher
 L1564-14 140mm
 L1564-17 170mm
 L1564-20 200mm

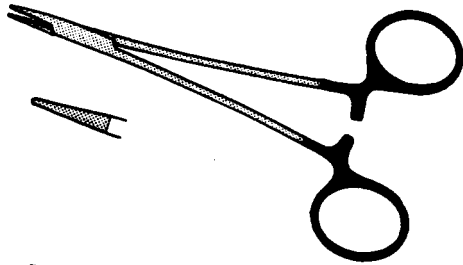

Lawrence
 L1567-15 150mm

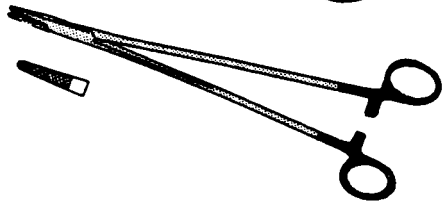

Masson
 L1570-27 270mm

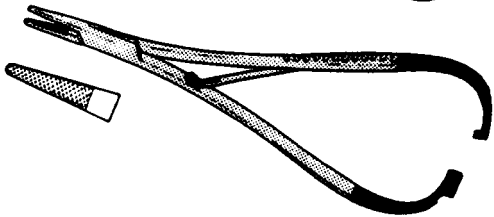

Mathieu
 L1573-14 140mm
 L1573-17 170mm
 L1573-20 200mm

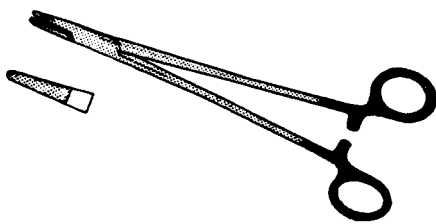

Mayo
 L1576-12 125mm
 L1576-14 140mm
 L1576-15 150mm
 L1576-16 165mm
 L1576-18 180mm
 L1576-19 185mm
 L1576-20 190mm
 L1576-21 200mm
 L1576-23 230mm
 L1576-25 255mm
 L1576-30 305mm

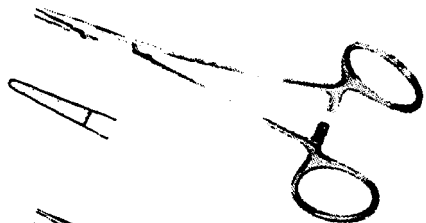

Neivert
 L6044-13 13cm

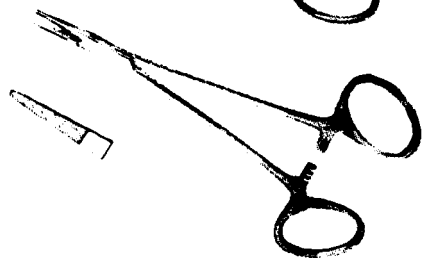

Neivert
 two rings angled
 L6045-13 13cm



Needleholders, Tungsten Carbide

Olsen-Hegar
L6080-14 14cm

Olsen-Hegar
L6080-17 17cm

Ryder
French eye
L1579-12 125mm
L1579-15 150mm
L1579-18 180mm
L1579-21 200mm
L1579-23 230mm
L1579-25 255mm

Sarot
L1581-17 175mm
L1581-26 260mm

Stratte
L1583-23 230mm

Thomson Walker
L1585-20 200mm

Tonnis
L1587-17 175mm

Wangensteen
L1589-27 270mm

Needles



Cooper
L1593-19 190mm



Aneurism
small curve
L1591-14 145mm



Deschamps
curved to left
L1595-27 270mm



curved to right
L1595-28 270mm



Dupuytren
curved to left
L1597-27 170mm



curved to right
L1597-28 170mm



Jolls
200mm
L1599-01 fig 1
L1599-02 fig 2
L1599-03 fig 3



Symes
L1601-16 165mm

Percussors



National Hospital
nylon handle, large rubber ring, 70mm diameter
L1605-35 355mm

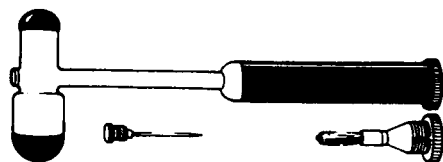

Neurological
rubber heads, brush and pin ends, black plastic handle
L1610-22 220mm

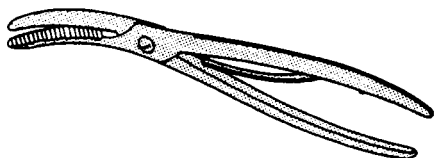

Bohler Bender
L1612-25 255mm

Plaster Instruments

Plaster Instruments

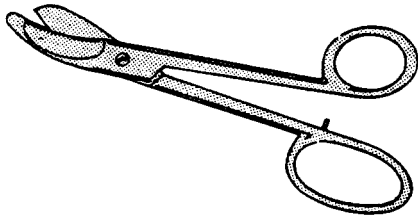
**Bruns/Bohler Shears**

saw edge
L1614-24 240mm

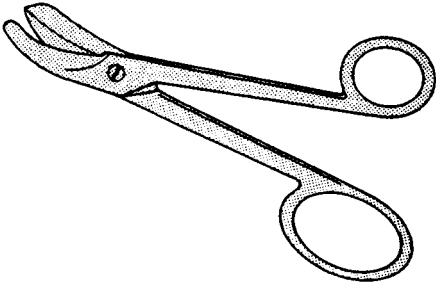
**Guy's Shears**

flattened end
L1615-29 290mm

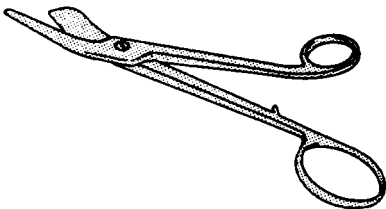
**Guy's Shears**

probe end
L1616-25

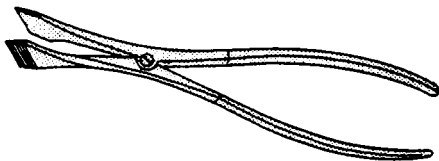
**Hennig Spreader**

L1619-8 280mm

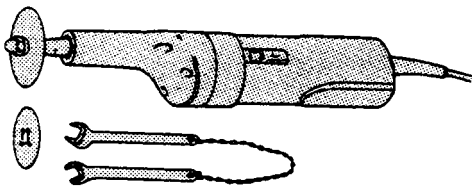
**Oscillatin Saw**

voltages available 110 -115V, 220 - 240V 50/60Hz single phase
L1620-20 complete with 2 blades
L1620-50 extractor unit
L1620-63 spare blade 63.5mm

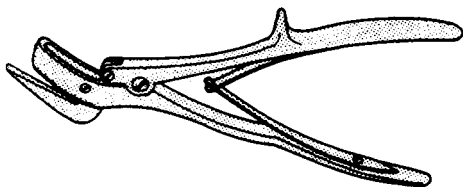
**Stille Shears**

L1622-24 240mm

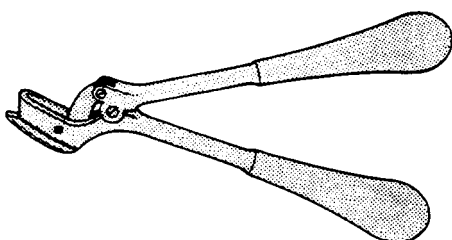
**Stille-Lorenz Shears**

L1625-23 230mm
L1625-26 260mm
L1625-37 370mm

Post Mortem Instruments

**Blowpipe**

L1630-15 150mm

L1630-20 200mm

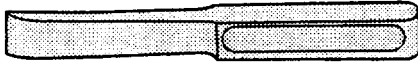
**Chisel**

L1635-19 19mm 175mm

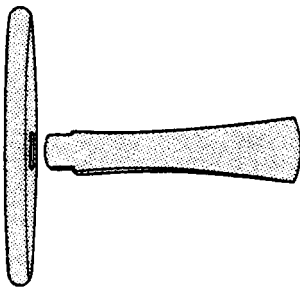
**Cross Handle Chisel**

L1636-25 25mm blade

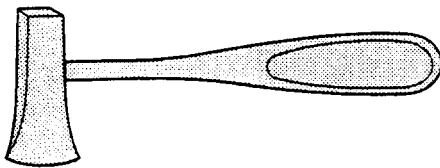
**Hammer**

wrench end

L1638-32 32mm blade

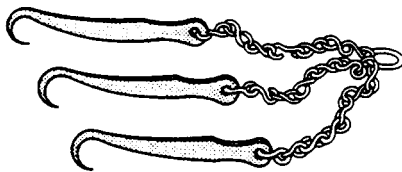
**Hook and Chain**

sharp, set of 3

L1641-85 85mm

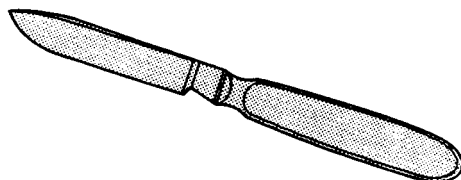
**Knife**

solid forged single edge

L1644-21 210mm, 85mm blade

L1644-22 220mm, 95mm blade

L1644-23 235mm, 108mm blade

L1644-24 245mm, 120mm blade

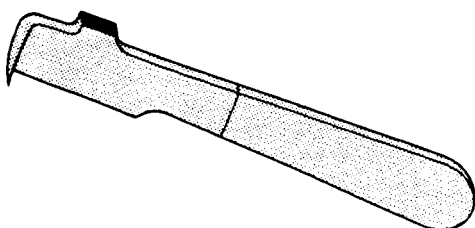
**Spine Wrench**

L1647-21 215mm

Probes

**Grooved**

straight

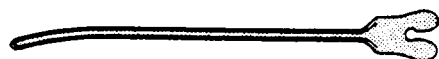
L1648-11 115mm**L1648-13** 130mm**L1648-14** 145mm**L1648-16** 160mm**L1648-18** 180mm**L1648-20** 200mm**L1648-25** 250mm**Grooved**

curved

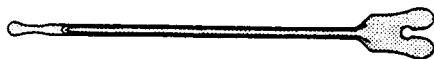
L1649-14 145**Grooved**

probe end

L1650-13 130mm**L1650-14** 145mm**L1650-16** 160mm**L1650-18** 180mm**Moynihan**

malleable, gallstone probe and scoop

L1651-35 350mm**Nickel Silver**

with eye

L1653-12 125mm**L1653-15** 150mm**L1653-18** 180mm**L1653-20** 200mm**L1653-25** 250mm**L1653-30** 300mm**Sinus**

silver

L1656-15 150mm**Stacke****L1657-10** 105mm

Retractors

**Canny Ryall**

fenestrated blade

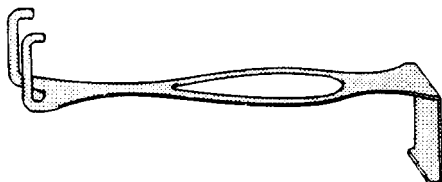
L1659-16 190mm, 16mm 25mm blade**L1659-19** 190mm, 19mm 28mm blade**L1659-25** 200mm, 25mm 32mm blade**Czerny**

double ended

L1662-18 180mm

Retractors

Deaver Abdominal

flat handles

- L1665-25** No. 1, 305mm, 25mm blade
L1665-26 No. 2, 330mm, 25mm blade
L1665-38 No. 3, 305mm, 38mm blade
L1665-50 No. 4, 305mm, 50mm blade
L1665-75 No. 5, 305mm, 75mm blade
L1665-80 set of 5

**Deaver Abdominal**

hollow handles

- L1666-25** No. 1, 305mm, 25mm blade
L1666-26 No. 2, 330mm, 25mm blade
L1666-38 No. 3, 305mm, 38mm blade
L1666-50 No. 4, 305mm, 50mm blade
L1666-75 No. 5, 305mm, 75mm blade
L1666-80 set of 5

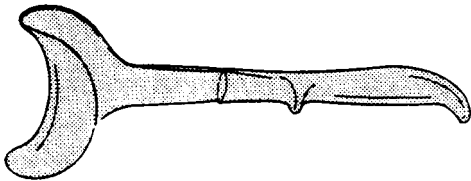
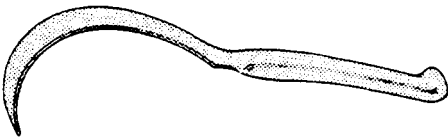
**Doyen**

250mm overall length

- L1669-50** 50mm 85mm blade

**Durham**

- L1672-10** 10mm blade
L1672-16 16mm blade
L1672-22 22mm blade

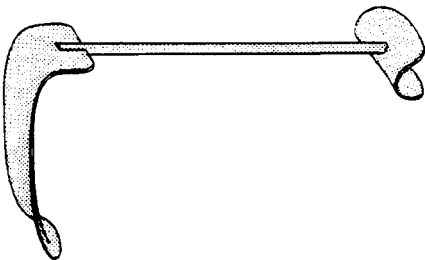
**Dyball and Lock**

single ended 240mm, 63mm 112mm blade

- L1675-24**

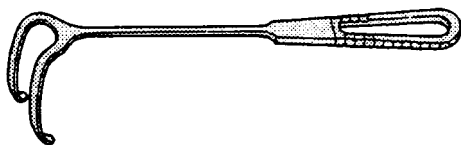
**Farabeuf**

- L1678-30** 30mm 13mm blade
L1678-40 40mm 25mm blade
L1678-60 60mm 37mm blade

**Hook**

continental pattern, blunt, 160mm

- L1681-01** 1 prong
L1681-02 2 prong
L1681-03 3 prong
L1681-04 4 prong



continental pattern, sharp, 160mm

- L1682-01** 1 prong
L1682-02 2 prong
L1682-03 3 prong
L1682-04 4 prong

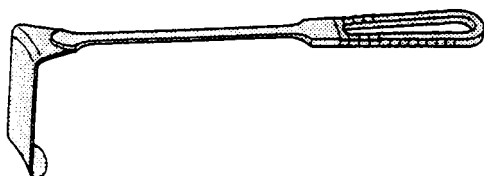
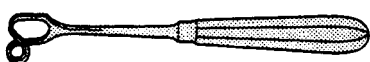
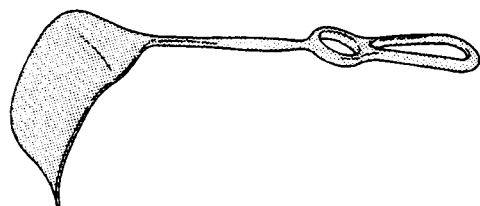
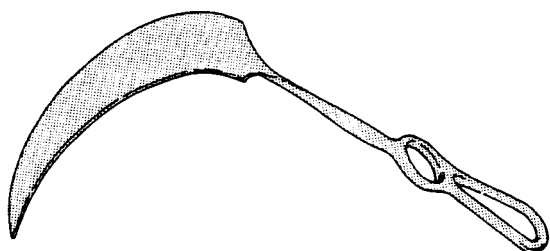

Retractors

**Hook**

continental pattern, flexible shaft, blunt, 160mm

L1683-01 1 prong

L1683-02 2 prong

L1683-03 3 prong

L1683-04 4 prong

continental pattern, flexible shaft, sharp, 160mm

L1684-01 1 prong

L1684-02 2 prong

L1684-03 3 prong

L1684-04 4 prong

Kelly

270mm overall length

L1686-38 185mm 38mm blade

L1686-57 185mm 57mm blade

Kocher

250mm overall length

L1688-42 80mm 42mm blade

L1688-50 80mm 50mm blade

L1688-60 80mm 60mm blade

Lane

double ended

L1690-13 230mm, 13mm 19mm blade

L1690-25 230mm, 25mm 32mm blade

Langenbeck

single ended

L1692-22 22mm 6mm blade

L1692-45 45mm 13mm blade

L1692-65 65mm 25mm blade

L1692-90 90mm 20mm blade

Middeldorph

215mm overall length

L1694-16 16mm 17mm blade

L1694-26 26mm 22mm blade

L1694-30 30mm 30mm blade

Morris

single ended

L1696-40 215mm, 70mm 40mm blade

L1696-50 215mm, 70mm 50mm blade

L1696-65 215mm, 70mm 65mm blade

Retractors

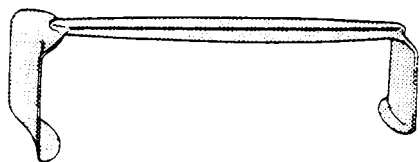
**Morris**

double ended

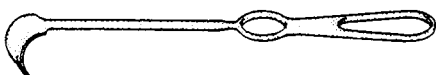
L1697-32 215mm, 32mm 50mm and 38mm 50mm blades**L1697-45** 215mm, 45mm 50mm and 50mm 50mm blades**L1697-65** 215mm, 65mm 50mm and 38mm 50mm blades**Moynihan nihan**

single ended

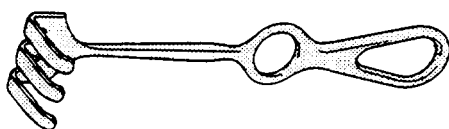
L1699-13 215mm, 13mm 22mm blade**Ollier**

single ended 3 prong

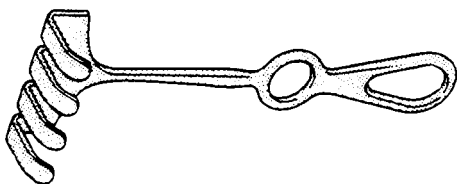
L1702-36 225mm, 36mm 30mm blade**Ollier**

single ended 4 prong

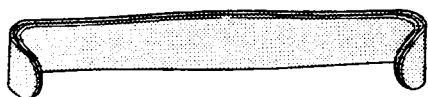
L1702-36 225mm, 36mm 55mm blade**Parker**

set of 2

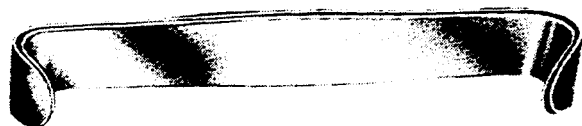
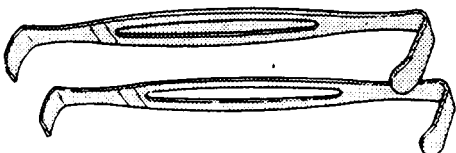
L1706-13 135mm**L1706-17** 175mm**Parker****L4495-13** 13cm**Parker****L4495-18** 18cm**Parker-Langenbeck (U S Army)**

set of 2

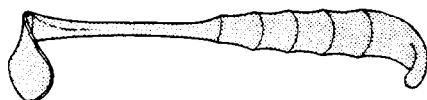
L1707-21 210mm**Richardson**

single ended

L1710-25 240mm, 25mm 20mm blade**L1710-30** 240mm, 30mm 28mm blade**L1710-38** 240mm, 38mm 37mm blade

Retractors

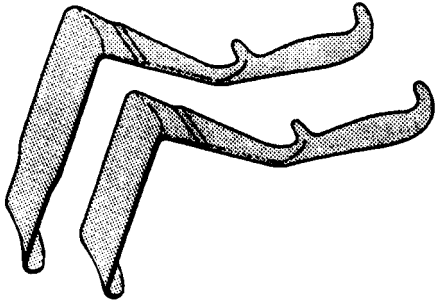
**St Marks Hospital**

with lip

L1713-12 125mm 60mm blade

L1713-17 175mm 60mm blade

**Tracheal Hook**

single

L1716-15 blunt, 150mm

**Tracheal Hook**

single

L1716-16 sharp, 150mm

**Tracheal Hook**

double

L1717-18 blunt, 180mm

L1717-19 sharp, 180mm

**Senn-Miller**

sharp

L4486-01 16cm

Senn-Miller

blunt

L4486-02 16cm

Baby-Senn-Miller

sharp

L4487-01 16cm

Baby-Senn-Miller

blunt

L4487-02 16cm

Retractors

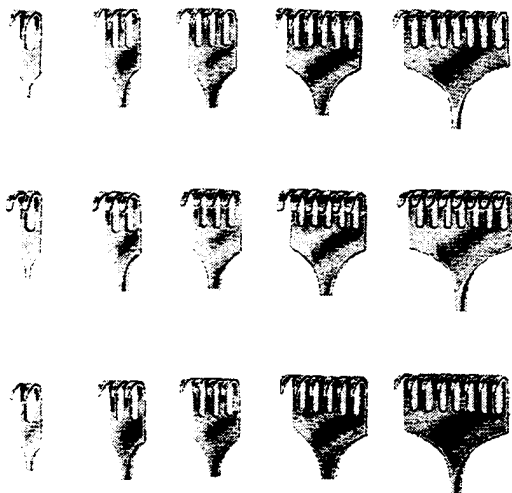
**Volkmann**

blunt, 220mm

L1719-01 1 prong

L1719-02 2 prong

L1719-03 3 prong

L1719-04 4 prong

L1719-06 6 prong

semi-sharp, 220mm

L1720-01 1 prong

L1720-02 2 prong

L1720-03 3 prong

L1720-04 4 prong

L1720-06 6 prong

sharp, 220mm

L1721-01 1 prong

L1721-02 2 prong

L1721-03 3 prong

L1721-04 4 prong

L1721-06 6 prong

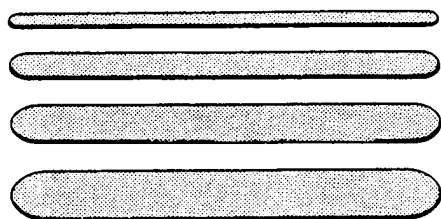
**Walton**

copper, malleable

L1724-13 305mm 13mm

L1724-19 305mm 19mm

L1724-25 305mm 25mm

L1724-32 305mm 32mm

L1724-38 305mm 38mm

L1724-50 305mm 50mm

Retractors, Amputation

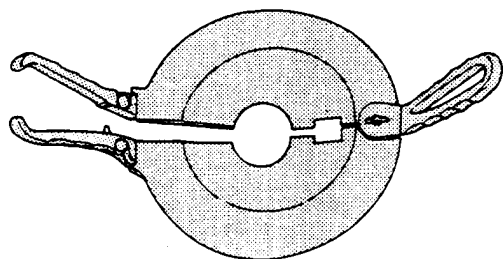
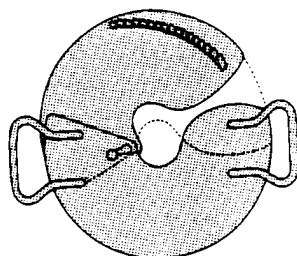
**Blake Flap**

L1727-24 240mm diameter

Percy

L1730-10 with detachable handles

Retractors, Self-Retaining

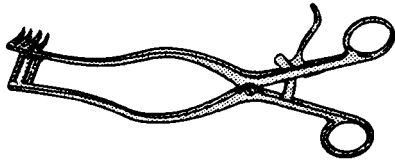
**Adson**

3/4 prong, 270mm
L1733-27 blunt
L1733-28 sharp

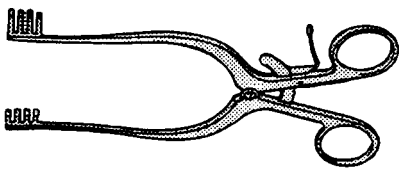
**Adson**

4/4 prong, 200 mm
L1734-20 blunt
L1734-21 sharp

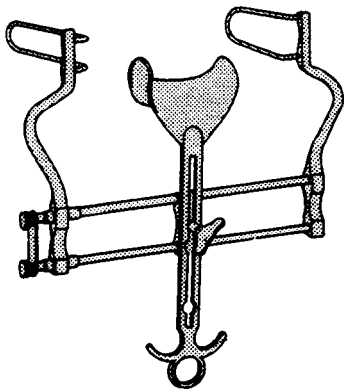
**Balfour**

fenestrated end blades 180mm, 63mm 35mm blades
L1737-63

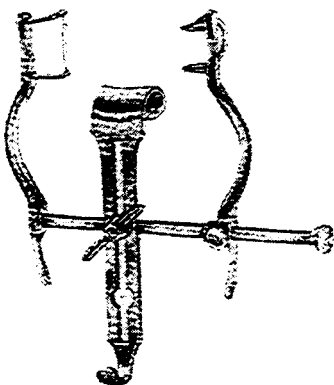
**Baby-Balfour**

L4798-00

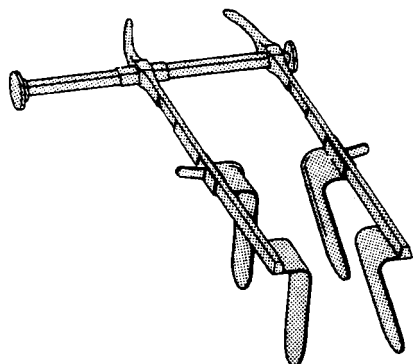
Retractors Self-Retaining**Berkeley Abdominal**

parallel action 35mm 60mm blades
L1740-35

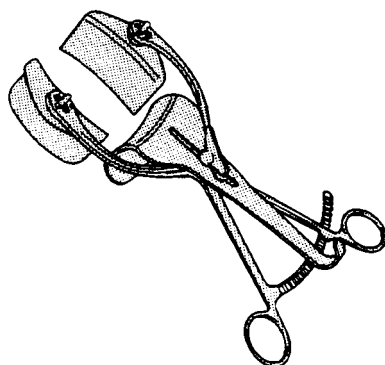
**Collin**

complete with centre blade 38mm 60mm blades
L1743-38

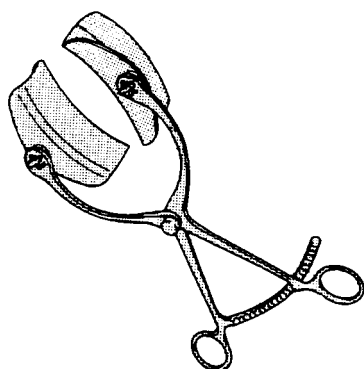
**Collin**

without centre blade 38mm 60mm blades
L1743-39

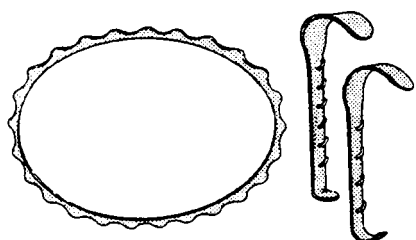
**Denis Browne**

frame and 4 blades 2 blades each 38mm 38mm and 38mm 25mm
L1746-38

Retractors, Self-Retaining

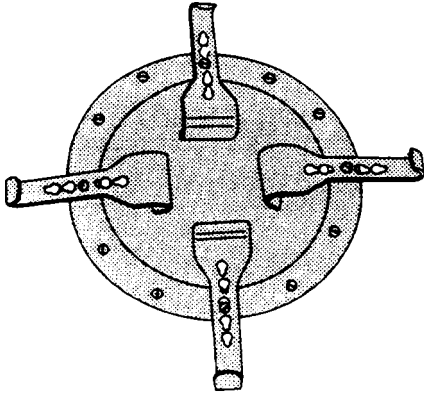
**Foerster**

transparent to x-ray, complete with 4 blades 2 blades each
75mm 65mm and 50mm 65mm
L1749-75

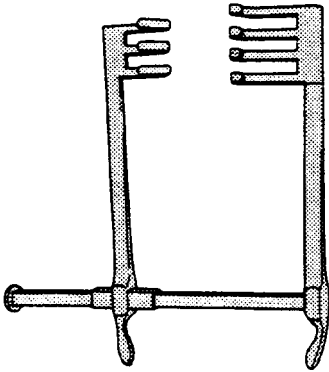
**Frazier**

blunt 165mm
L1751-16

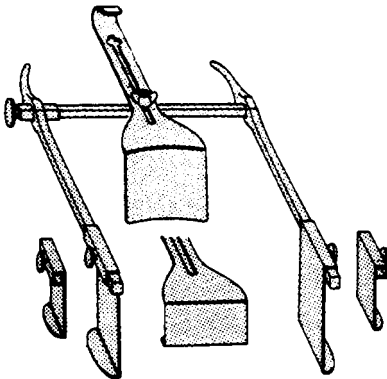
**Goligher**

complete 165mm 2 centre blades, 2 lateral blades 51mm deep
and 2 lateral blades 100mm deep
L1753-16

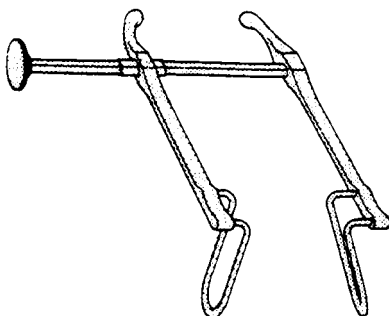
**Gossett**

2 blades
L1755-15 large
L1755-16 small

Retractors, Self-Retaining

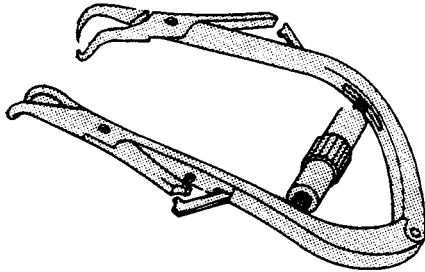

Jolls Thyroid
L1758-15 150mm

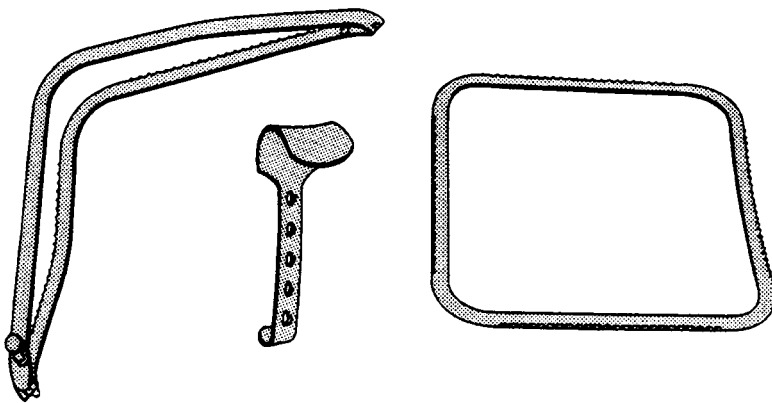

Kirschner
with rigid frame and 4 blades 2 blades
each 40mm 55mm and
65mm 80mm
L1761-40

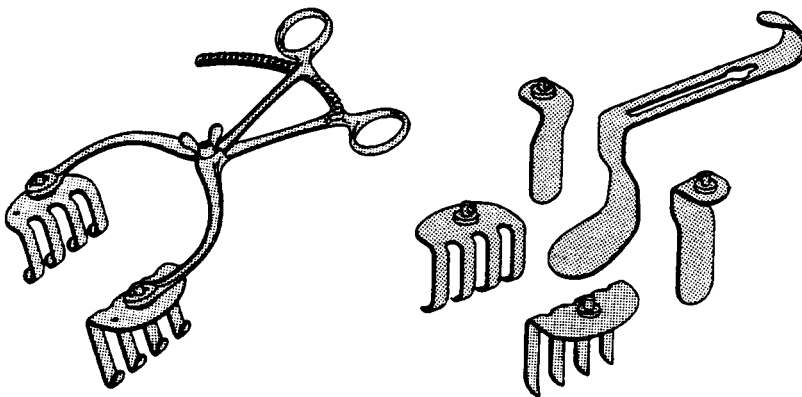

Lace
2 blades each 70mm 45mm,
70mm 50mm and 28mm 75mm,
Center
blade 110 48mm
L1764-70

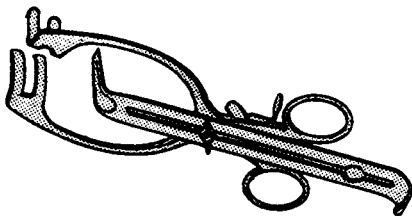

Mayo Adams
complete with centre blade
L1787-17 170mm

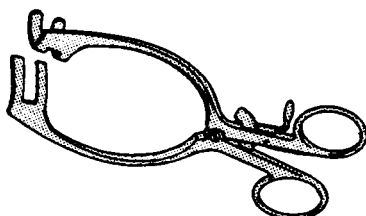

Mayo Adams
without centre blade
L1767-18 170mm

Retractors, Self-Retaining

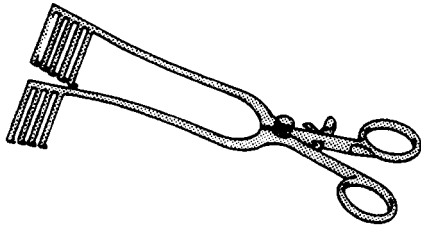
**Norfolk and Norwich**

cam rack, 4/5 teeth
L1770-21 215mm, 50mm blades

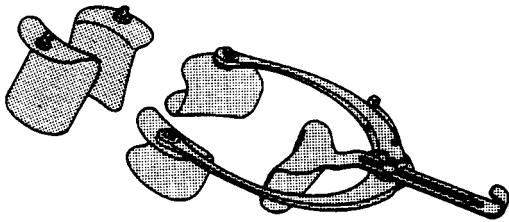
**Ricard Begouin**

L1773-20 200mm, 30mm 65mm and
65mm 65mm blades

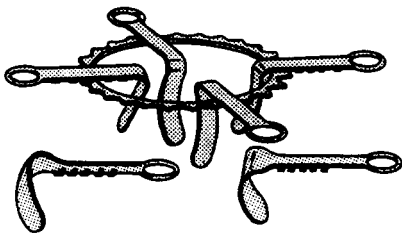
**Swift Joly Abdominal**

L1776-06 circular frame with 6 blades

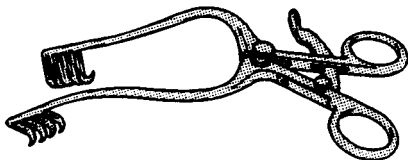
**Travers**

4/5 teeth
L1778-20 200mm

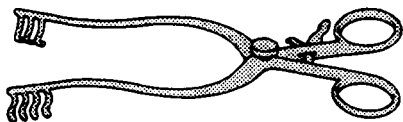
**Weitlaner**

blunt
L1782-14 140mm
L1782-17 170mm
sharp
L1783-14 140mm
L1783-17 170mm

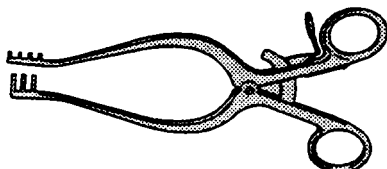
**Weitlaner**

blunt
L1782-20 200mm
L1782-24 240mm
sharp
L1783-20 200mm
L1783-24 240mm

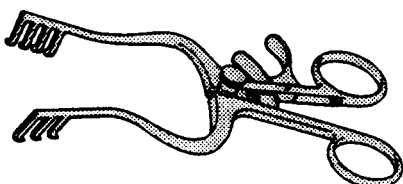
**West**

sharp
L1785-14 140mm

Ring Cutter

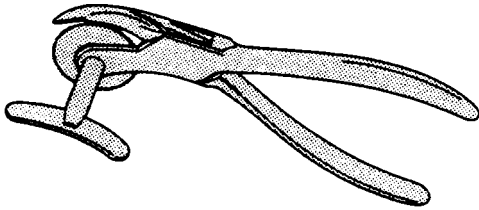

Complete
 L1788-16 165mm
 spare blade
 L1788-18 carbon steel

Saws

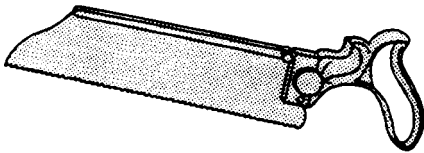

Amputation
 L1791-20 200mm
 L1791-22 225mm

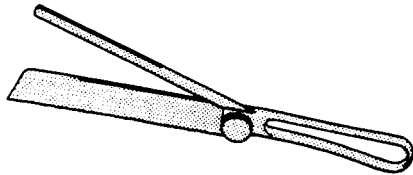

Army
 L1793-17 175mm

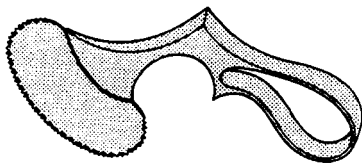

Engels
 L1795-18 plaster saw

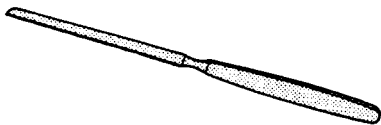

Langenbeck
 L1797-23 230mm

Scalpels

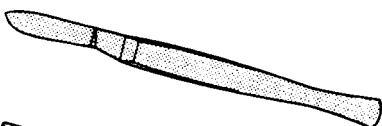

Solid Forged
 stainless steel
 L1800-01 size No. 1
 L1800-02 size No. 2
 L1800-03 size No. 3



Swann Morton
 handle
 L1802-30 No. 3

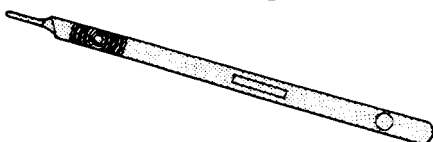

Swann Morton
 handle
 L1802-32 No. 3L

Scalpels

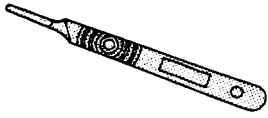

Swann Morton
handle
L1802-34 No. 4

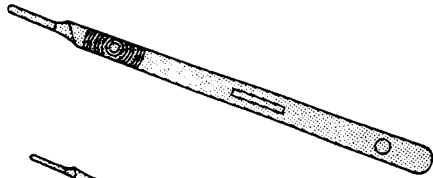

Swann Morton
handle
L1802-36 No. 4L

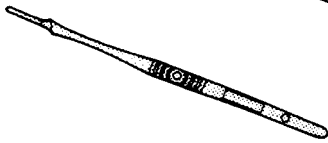

Swann Morton
handle
L1802-38 No.5

Scissors

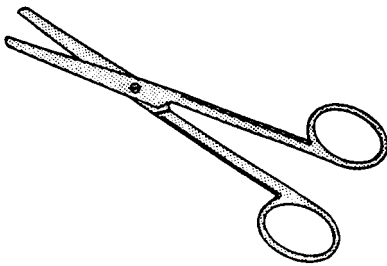

Alandolt
straight
L1815-12 125mm

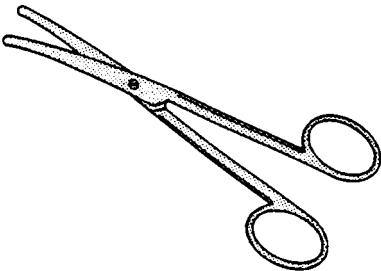

Alandolt
curved
L1816-12 125mm

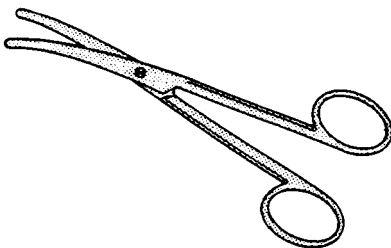

Alandolt
medium Curve
L1817-12 125mm

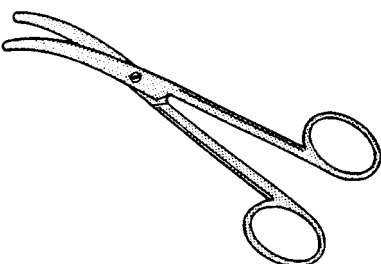

Alandolt
acute curve
L1818-12 125mm

Scissors

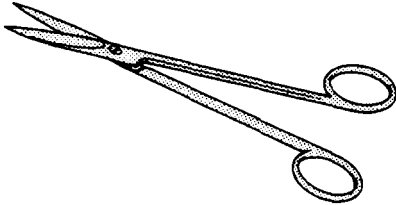

Aufricht Dissecting
straight, light pattern
L1820-15 150mm

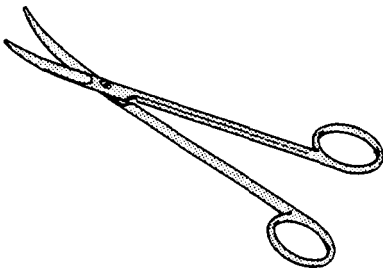

Aufricht Dissecting
curved, light pattern
L1821-15 150mm

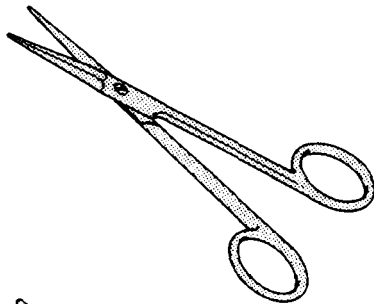

Aufricht Dissecting
straight, triangular blade
L1822-14 140mm
curved, triangular blade
L1823-14 140mm

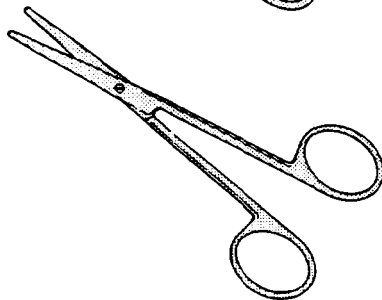

Baby-Lexer
straight
L1825-10 100mm

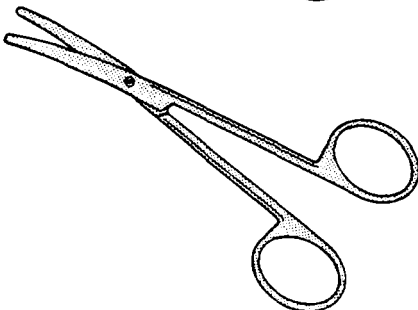

Baby-Lexer
curved
L1826-10 100mm

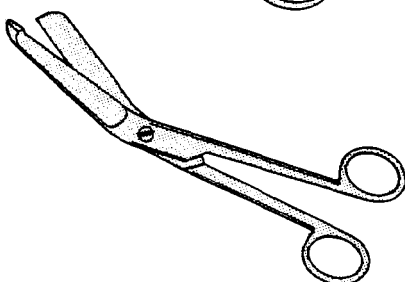

Bergmann
L1829-23 230mm

Scissors

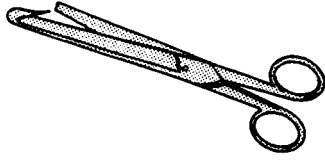

Bowel
hook end
L1832-17 175mm

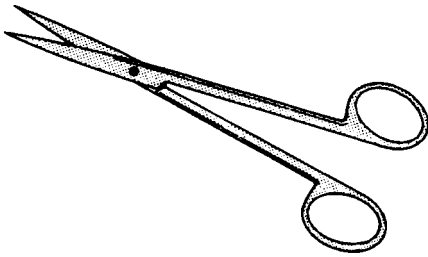

Brophy
straight
L1835-14 145mm

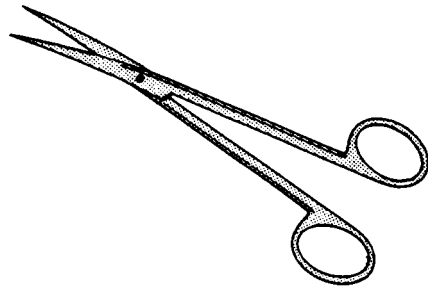

Brophy
curved
L1836-14 145mm

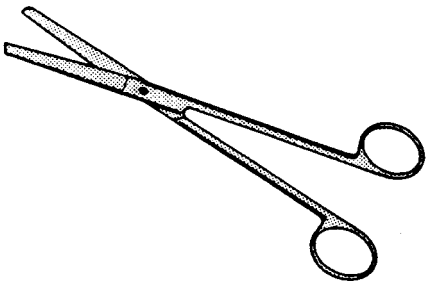

Carless
straight, lightweight, blunt point
L1838-18 185mm
L1838-20 200mm

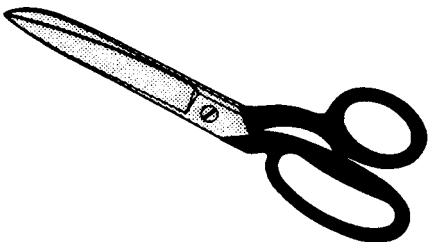

Counter
carbon steel shaped black bows
L1839-17 175mm
L1839-20 205mm
L1839-22 225mm

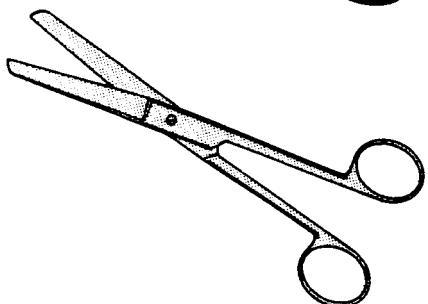

Doyen
straight, blunt point
L1840-18 180mm

Scissors

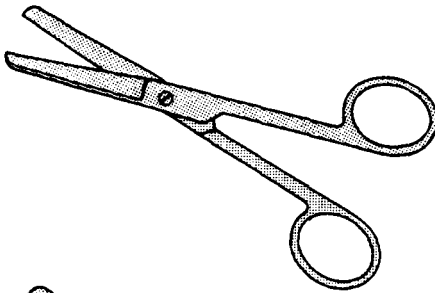
**Dressing**

straight, blunt/blunt
L1842-10 100mm
L1842-12 125mm
L1842-14 140mm
L1842-15 150mm
L1842-18 180mm
L1842-20 200mm

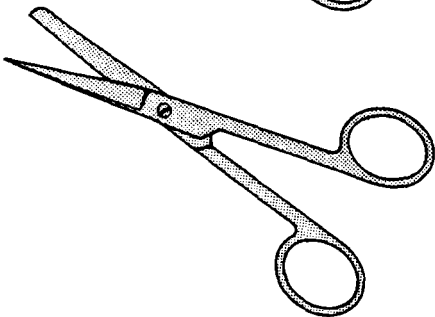
**Dressing**

straight, blunt/sharp
L1843-10 100mm
L1843-12 125mm
L1843-14 140mm
L1843-15 150mm
L1843-18 180mm
L1843-20 200mm

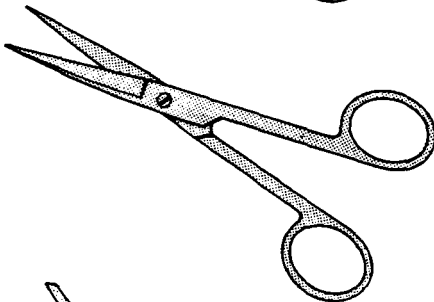
**Dressing**

straight, sharp/sharp
L1844-10 100mm
L1844-12 125mm
L1844-14 140mm
L1844-15 150mm
L1844-18 180mm
L1844-20 200mm

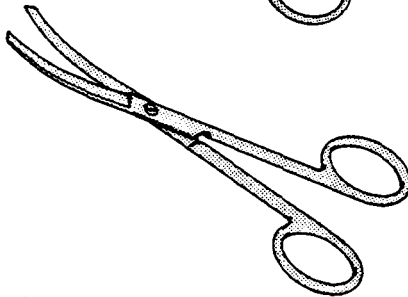
**Dressing**

curved, blunt/blunt
L1845-10 100mm
L1845-12 125mm
L1845-14 140mm
L1845-15 150mm
L1845-18 180mm
L1845-20 200mm

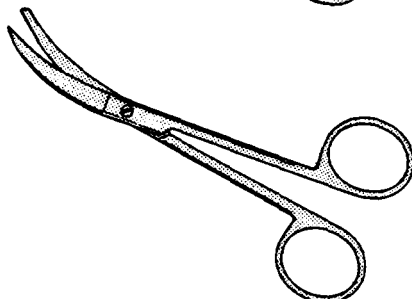
**Dressing**

curved, blunt/sharp
L1846-10 100mm
L1846-12 125mm
L1846-14 140mm
L1846-15 150mm
L1846-18 180mm
L1846-20 200mm

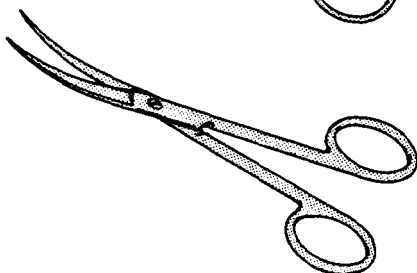
**Dressing**

curved, sharp/sharp
L1847-10 100mm
L1847-12 125mm
L1847-14 140mm
L1847-15 150mm
L1847-18 180mm
L1874-20 200mm

Scissors

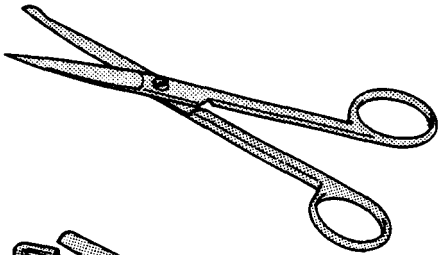
**Dressing**

straight, probe/sharp
L1848-12 125mm
L1848-14 145mm
L1848-16 165mm

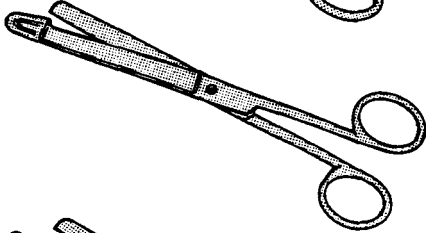
**Enterotomy**

hook end
L1851-21 210mm

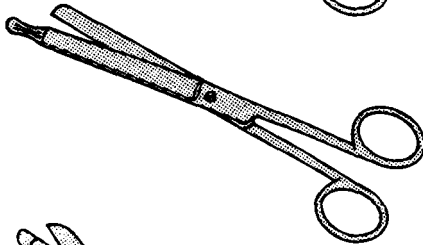
**Enterotomy**

probe end
L1852-21 210mm

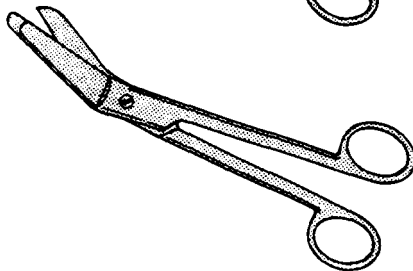
**Esmarch**

L1855-20 200mm
L1855-22 220mm

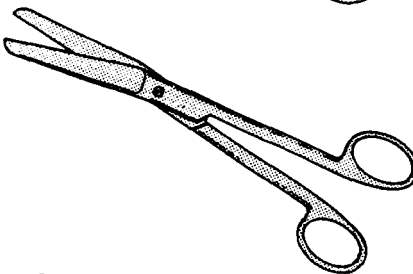
**Fergusson**

L1858-14 145mm
L1858-15 150mm
L1858-18 180mm

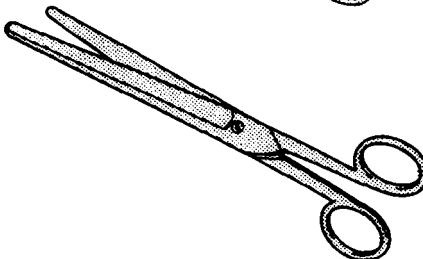
**Guy's**

L1861-19 190mm

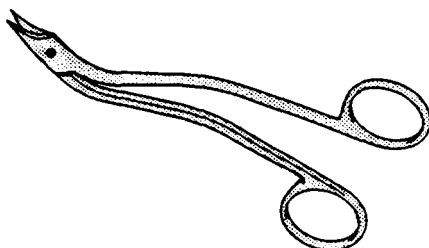

Heaths Stitch
L1864-15 150mm

Scissors

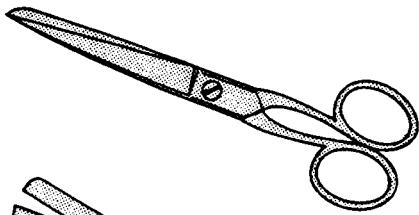
**Household**

nickel plated
L1865-12 125mm
L1865-15 150mm
L1865-17 175mm

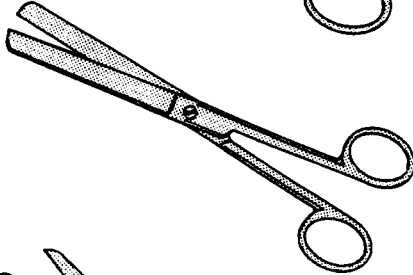
**Lange**

L1867-17 175mm

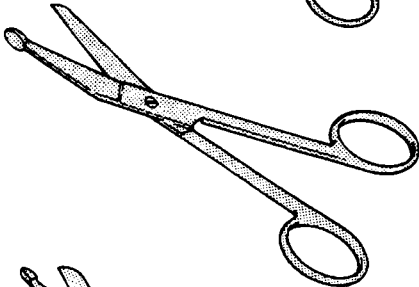
**Listers Bandage**

L1869-14 140mm
L1869-18 180mm
L1869-20 200mm
L1869-23 235mm

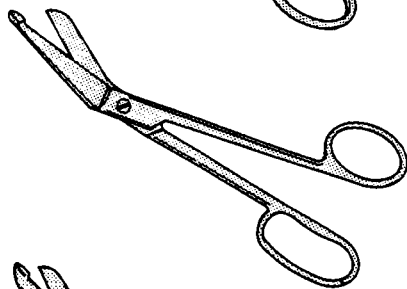
**Listers Bandage**

with double finger bow
L1870-18 185mm
L1870-21 210mm

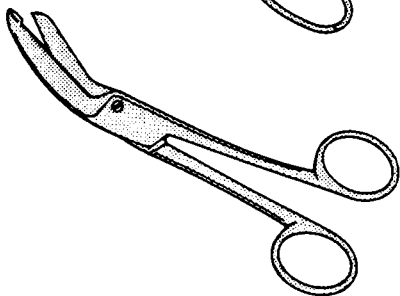
**Listers, Eccentric**

L1871-16 160mm
L1871-19 190mm

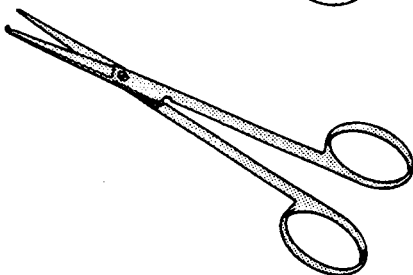
**Littauer**

miniature, straight with hook end
L1874-12 120mm

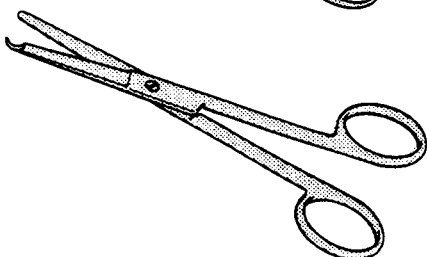
**Littauer**

straight with hook end
L1875-12 125mm
L1875-14 140mm
L1875-18 180mm

Scissors

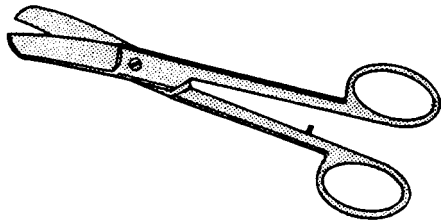

Lorenz
L1878-23 230mm

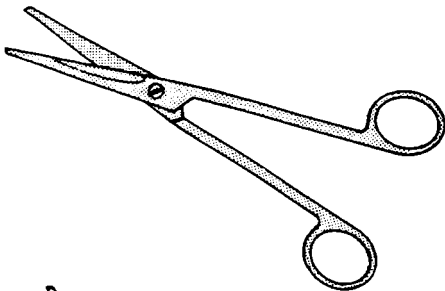

Mayo
straight, bevelled blades
L1881-14 140mm
L1881-16 165mm
L1881-19 190mm
L1881-21 215mm

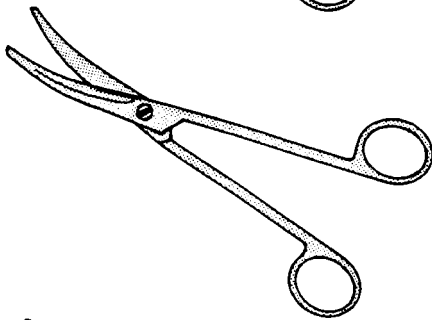

Mayo
curved, bevelled blades
L1882-14 140mm
L1882-16 165mm
L1882-19 190mm
L1882-21 215mm

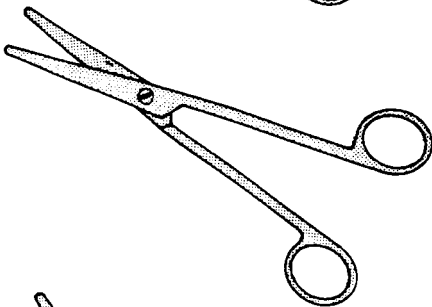

Mayo
straight, round blades
L1883-14 140mm
L1883-17 170mm

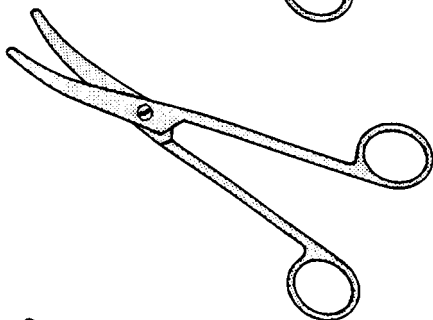

Mayo
curved, round blades
L1884-14 140mm
L1884-17 170mm

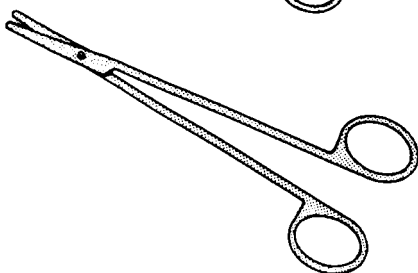

Metzenbaum
straight, blunt/blunt
L1887-17 175mm
L1887-20 200mm
L1887-23 230mm
L1887-25 250mm
L1887-28 280mm
L1887-30 300mm

Scissors

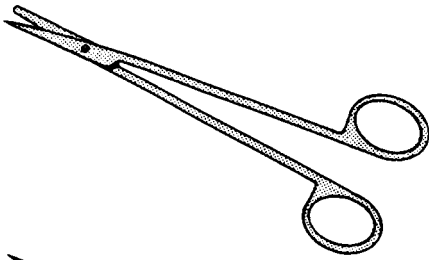
**Metzenbaum**

straight, blunt/sharp

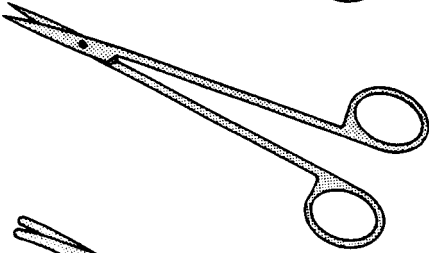
L1888-17 175mm**L1888-20** 200mm**L1888-23** 230mm**L1888-25** 250mm**L1888-28** 280mm**L1888-30** 300mm**Metzenbaum**

straight, sharp/sharp

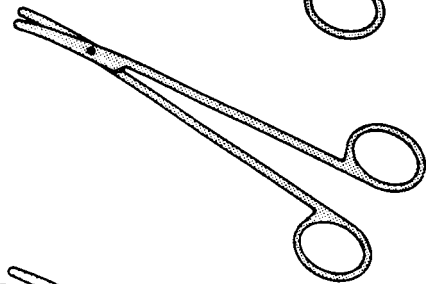
L1889-17 175mm**L1889-20** 200mm**L1889-23** 230mm**L1889-25** 250mm**L1889-28** 280mm**L1889-30** 300mm**Metzenbaum**

curved, blunt/blunt

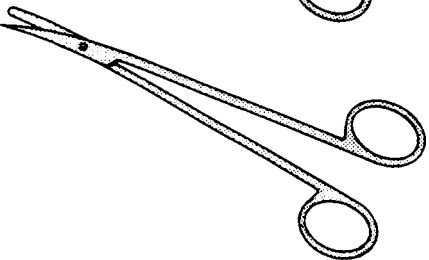
L1890-17 175mm**L1890-20** 200mm**L1890-23** 230mm**L1890-25** 250mm**L1890-28** 280mm**L1890-30** 300mm**Metzenbaum**

curved, blunt/sharp

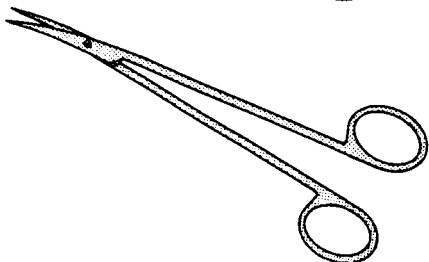
L1891-17 175mm**L1891-20** 200mm**L1891-23** 230mm**L1891-25** 250mm**L1891-28** 280mm**L1891-30** 300mm**Metzenbaum**

curved, sharp/sharp

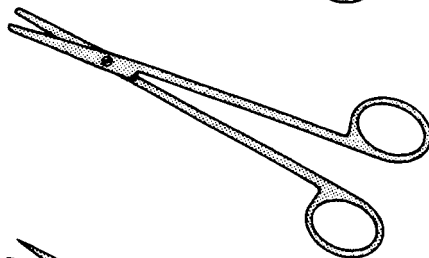
L7892-17 175mm**L1892-20** 200mm**L1892-23** 230mm**L1892-25** 250mm**L1892-28** 280mm**L1892-30** 300mm**Metzenbaum, fine**

straight, blunt/blunt

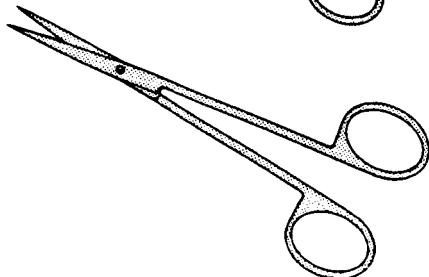
L1893-14 145mm**L1893-17** 175mm**L1893-20** 200mm**L1893-23** 230mm**L1893-25** 250mm**L1893-28** 280mm**L1893-30** 300mm**Metzenbaum, fine**

straight, sharp/sharp

L1894-14 145mm

Scissors

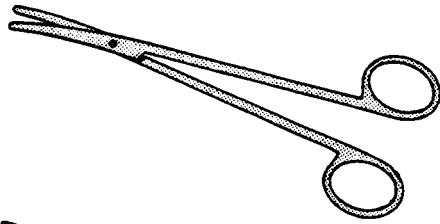
**Metzenbaum, fine**

curved, blunt/blunt

L1895-14 145mm**L1895-17** 175mm**L1895-20** 200mm**L1895-23** 230mm**L1895-25** 250mm**L1895-28** 280mm**L1895-30** 300mm

curved, sharp/sharp

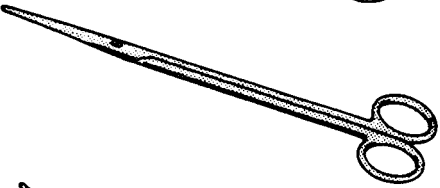
L1896-14 145mm**Nelson Lobectomy**

straight

L1898-23 230mm**Nelson Lobectomy**

curved

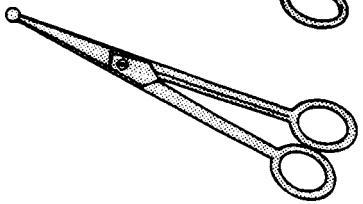
L1899-23 230mm**Post Mortem**

ball end, open shank

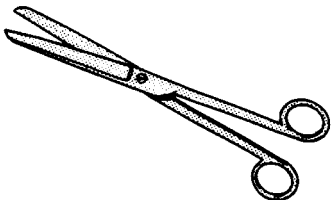
L1900-14 140mm**Post Mortem**

closed shank

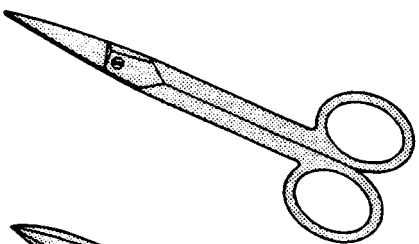
L1901-25 250mm**Post Mortem**

fine point, closed shank

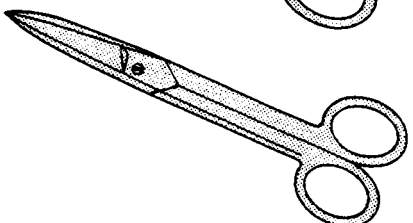
L1902-12 125mm**Post Mortem**

heavy, closed shank

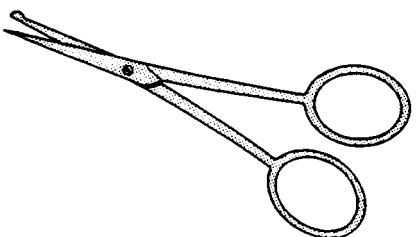
L1903-16 160mm**Post Mortem**

probe/sharp, open shank

L1904-10 100mm

Scissors

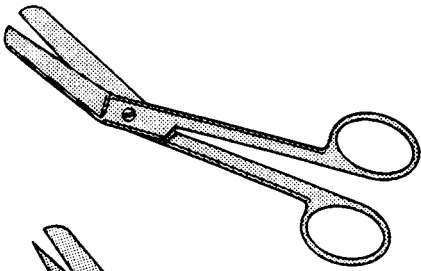

Richter
blunt/blunt
L1-1907-14 145mm

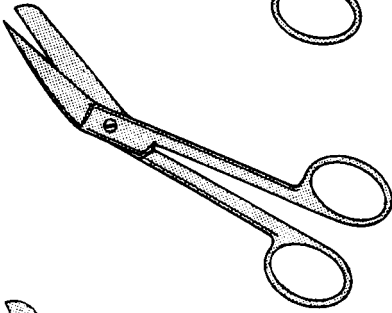

Richter
blunt/sharp
L1-1908-14 145mm

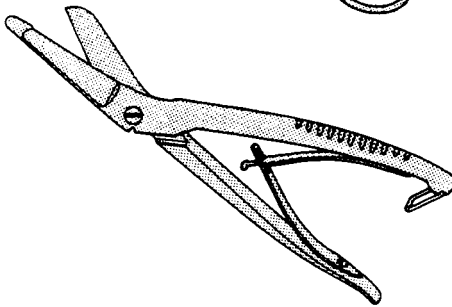

Seutin
saw edge
L1-1911-20 200mm

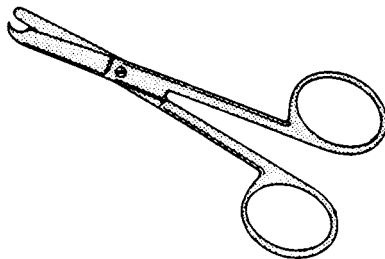

Spencer
hook end
L1-1914-10 105mm

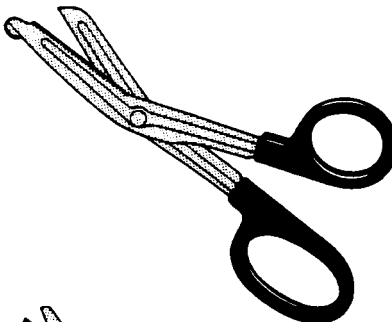

Universal Bandage
saw edge, autoclavable handles
L1-1917-17 175mm

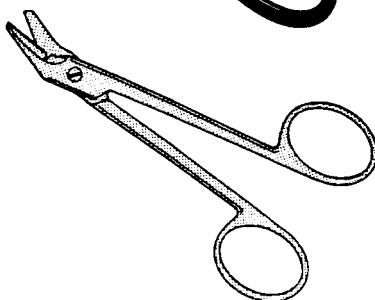

Universal Wire Cutting
saw edge
L1-1920-12 120mm

Scissors, Tungsten Carbide

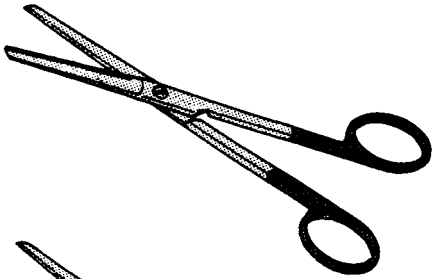
**Dressing**

straight, blunt/blunt
L1923-14 145mm

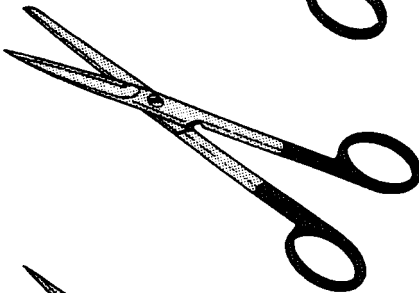
**Dressing**

straight, blunt/sharp
L1924-14 145mm

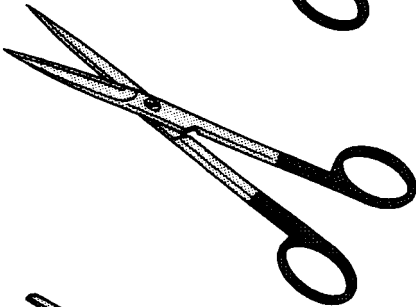
**Dressing**

straight, sharp/sharp
L1925-14 145mm

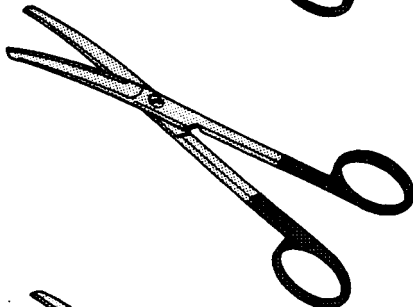
**Dressing**

curved, blunt/blunt
L1926-14 145mm

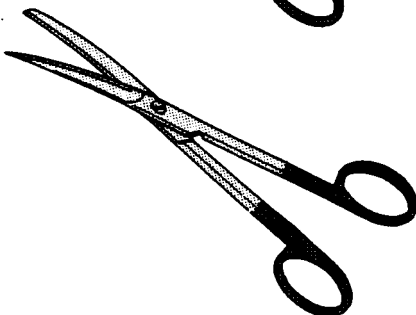
**Dressing**

curved, blunt/sharp
L1927-14 145mm

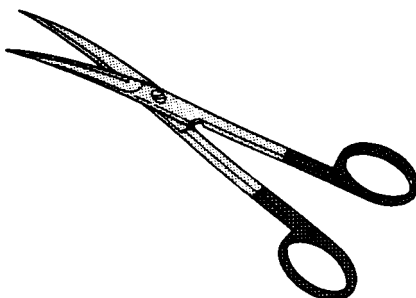
**Dressing**

curved, sharp/sharp
L1928-14 145mm

Scissors, Tungsten Carbide

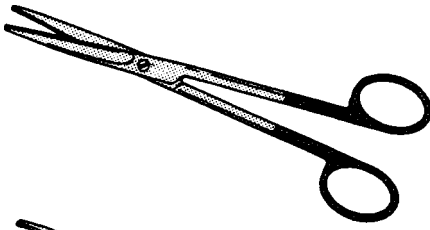
**Mayo**

straight

L1931-14 145mm

L1931-17 170mm

L1931-23 230mm

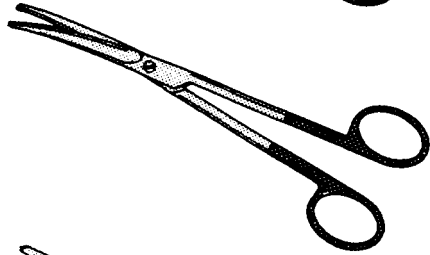
**Mayo**

curved

L1932-14 145mm

L1932-17 170mm

L1932-23 230mm

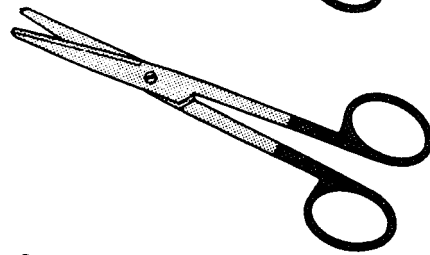
**Mayo-Stillie**

straight

L1934-15 150mm

L1934-17 170mm

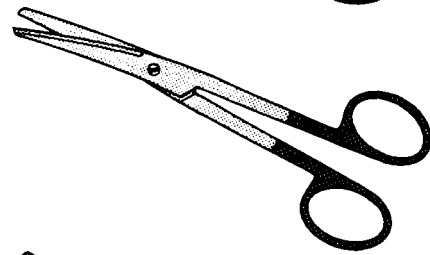
**Mayo-Stillie**

curved

L1935-15 150mm

L1935-17 170mm

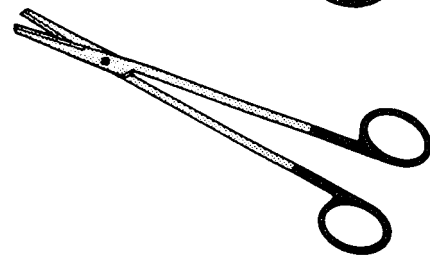
**Metzenbaum**

straight, blunt/blunt

L1938-14 145mm

L1938-17 175mm

L1938-20 200mm

L1938-23 230mm

L1938-25 250mm

L1938-28 280mm

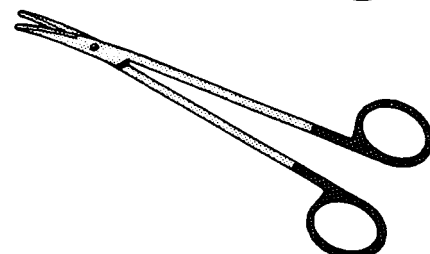
**Metzenbaum**

curved, blunt/blunt

L1939-14 145mm

L1939-17 175mm

L1939-20 200mm

L1939-23 230mm

L1939-25 250mm

L1939-28 280mm

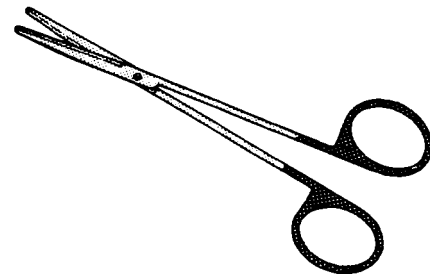
**Metzenbaum, fine**

straight, blunt/blunt

L1940-14 145mm

L1940-17 175mm

L1940-20 200mm

L1940-23 230mm

L1940-25 250mm

L1940-28 280mm

Scissors, Tungsten Carbide

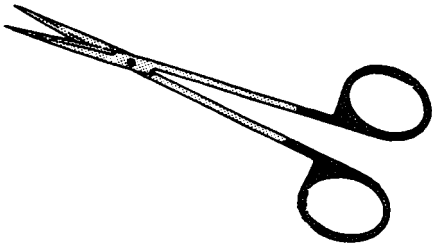
**Metzenbaum, fine**

straight, sharp/sharp

L1941-14 145mm

L1941-17 175mm

L1941-20 200mm

L1941-23 230mm

L1941-25 250mm

L1941-28 280mm

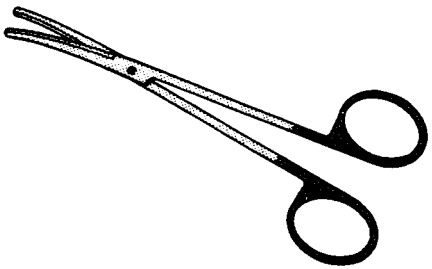
**Metzenbaum, fine**

curved, blunt/blunt

L1942-14 145mm

L1942-17 175mm

L1942-20 200mm

L1942-23 230mm

L1942-25 250mm

L1942-28 280mm

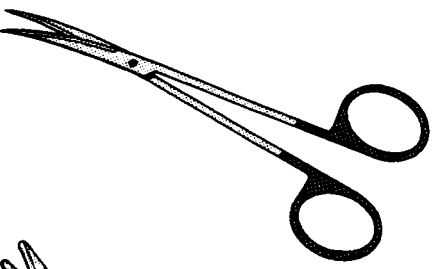
**Metzenbaum, fine**

curved, sharp/sharp

L1943-14 145mm

L1943-17 175mm

L1943-20 200mm

L1943-23 230mm

L1943-25 250mm

L1943-28 280mm

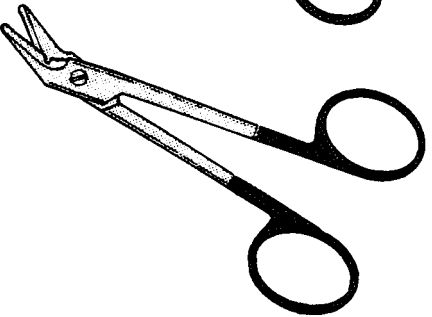
**Universal Wire Cutting**

L1947-12 120mm

Scissors, Micro Cutting

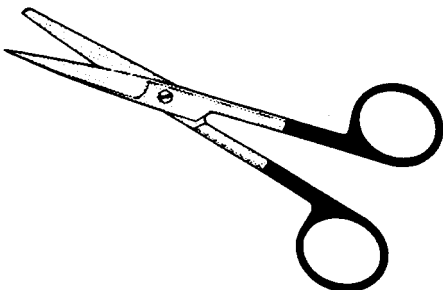
**Dressing**

straight, blunt/sharp

L1950-14 145mm

curved, blunt/sharp

L1951-14 145mm

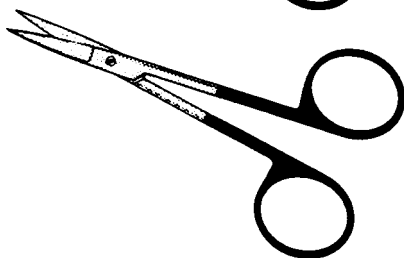
**Iris**

straight

L1955-11 115mm

curved

L1956-11 115mm

Scissors, Micro Cutting

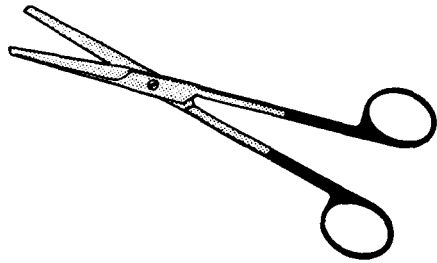
**Mayo**

straight

L1965-14 145mm**L1965-17** 170mm**L1965-23** 230mm

curved

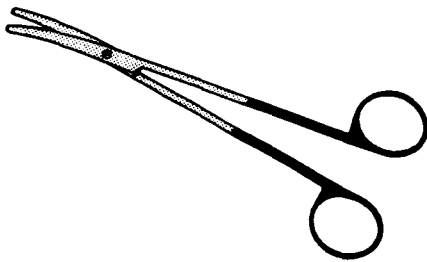
L1966-14 145mm**L1966-17** 170mm**L1966-23** 230mm**Metzenbaum**

straight

L1970-14 145mm

curved

L1971-14 145mm**L1971-18** 180mm**L1971-20** 200mm**L1971-23** 230mm

Scissors, Micro, Tungsten Carbide

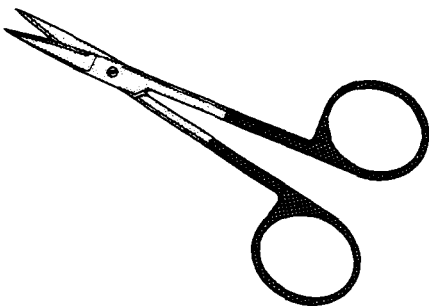
**Iris**

straight

L1975-11 115mm

curved

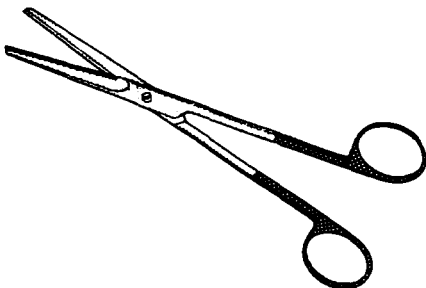
L1976-11 115mm**Mayo**

straight

L1980-17 170mm

curved

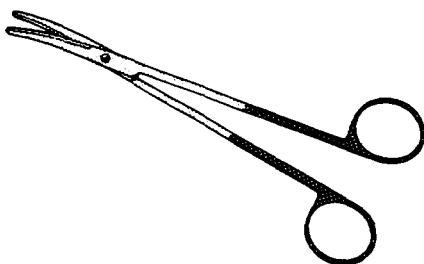
L1981-17 170mm**Metzenbaum**

curved

L1985-14 145mm**L1985-18** 180mm**L1985-23** 230mm

Scoops

**Cheatele Gall Stone**

hook end
L1990-33 330mm

Sinus Forceps

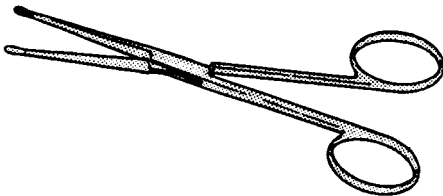
**Lister**

serrated tip
L1999-12 125mm
L1999-15 150mm
L1999-18 180mm
L1999-21 200mm

Sphygmomanometers

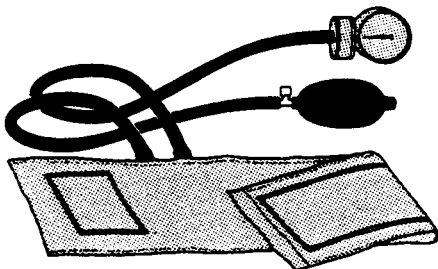
**Aneroid**

with velcro cuff in black zip-up case
L2060-05 complete
L2060-10 spare gauge
L2060-15 spare case

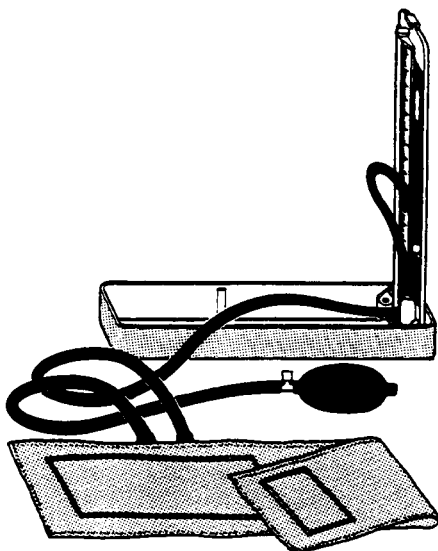
**Mercury**

desk type, 300mm Hg, in aluminium case
L2060-20 complete
L2060-25 spare cuff, velcro
L2060-30 spare bladder
L2060-35 spare bulb
L2060-40 spare control valve
L2060-45 spare end valve
L2060-50 spare tube, glass

Splinter Forceps

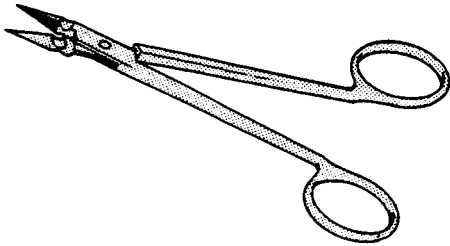

Arthur
pointed serrated jaws
L2062-12 125mm

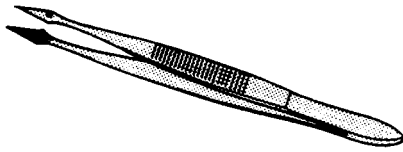

Hunter
straight
L2065-10 105mm

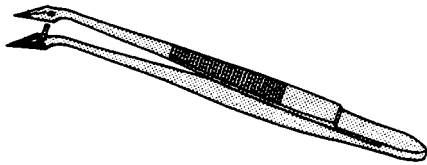

Hunter
curved
L2065-11 105mm

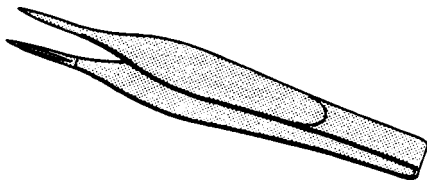

Martin
L2066-07 75mm
L2066-09 90mm
L2066-11 115mm

Sponge Holding Forceps

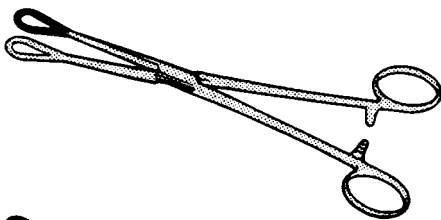

Foerster
straight, serrated jaws
L2068-18 180mm
L2068-24 240mm

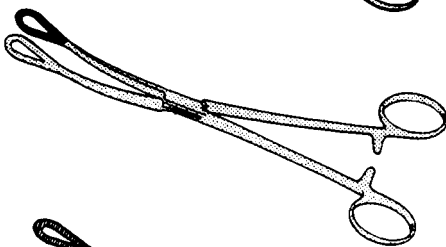

Foerster
curved, serrated jaws
L2069-18 180mm
L2069-24 240mm

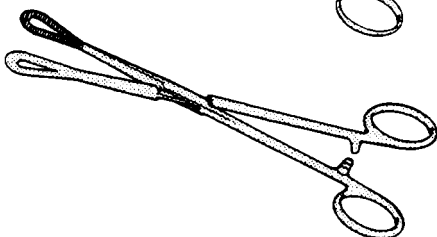

Rampley
straight, serrated jaws
L2071-18 180mm
L2071-24 240mm

Steriliser Forceps

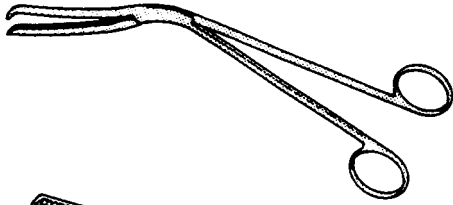

Cheatle
light, box joint
L2073-26 265mm

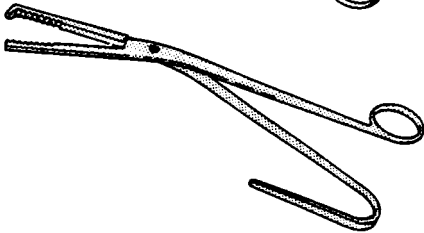

Cheatle
heavy, screw joint
L2073-29 290mm

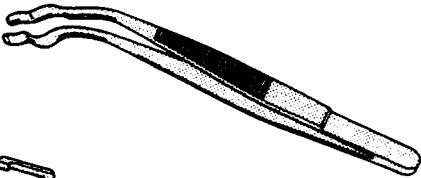

Davis
L2074-16 160mm
L2074-20 200mm
L2074-24 240mm

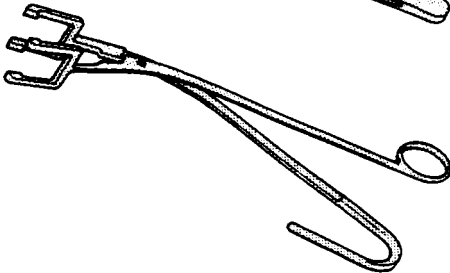

Harrison Bowl
double jawed, screw joint
L2076-35 355mm
L2076-45 455mm

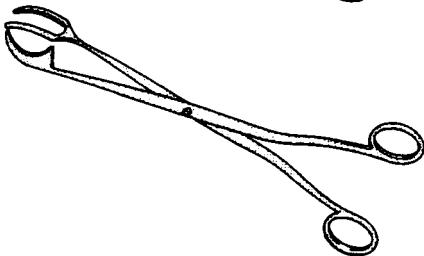

Rogge
screw joint
L2078-23 230mm

Stethoscopes

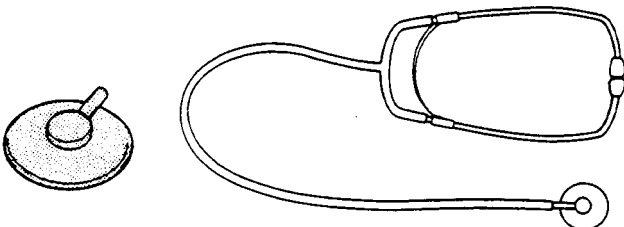

Nurse
single head
L2080-05 complete

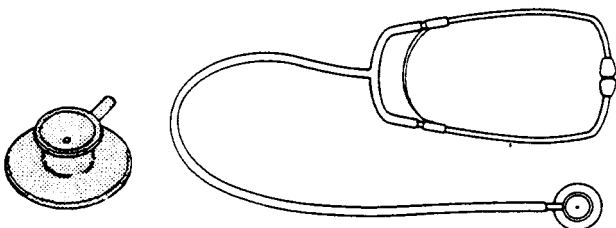

Popular
dual head
L2081-05 complete

Stethoscopes

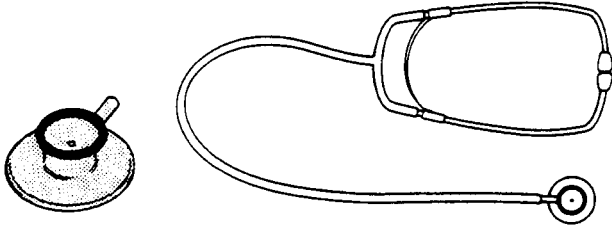

Doctor
 duel head with non-chill ring
 L2082-05 complete

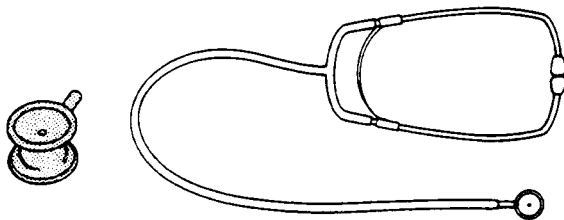

Infant
 duel head
 L2083-05 complete

Spare Tubing
 L2089-10 various colours

Spare Headframe
 L2089-12 binaural

Spare Ear Nibs
 L2089-14 pair

Suction Tubes



American Pattern
 with stilllette
 L2093-10 chrome plated

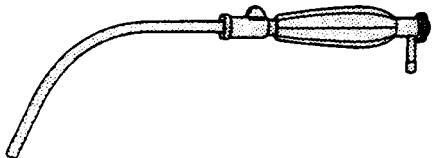

Millin
 L2105-10 chrome plated

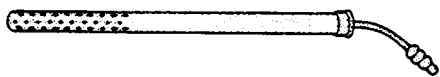

Poole
 chrome plated, curved
 L2110-24 240mm



Lawrie Extension
 L2111-17 175mm

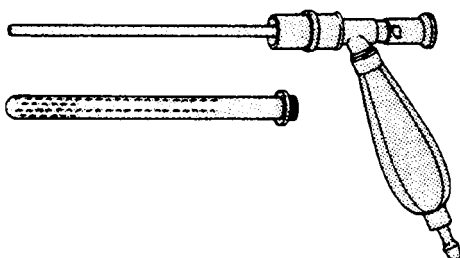

Tinckler (Simpson Smith)
 with on/off valve, removable perforated outer sheath and handle
 L2115-15 150mm 255mm

Suction Tubes

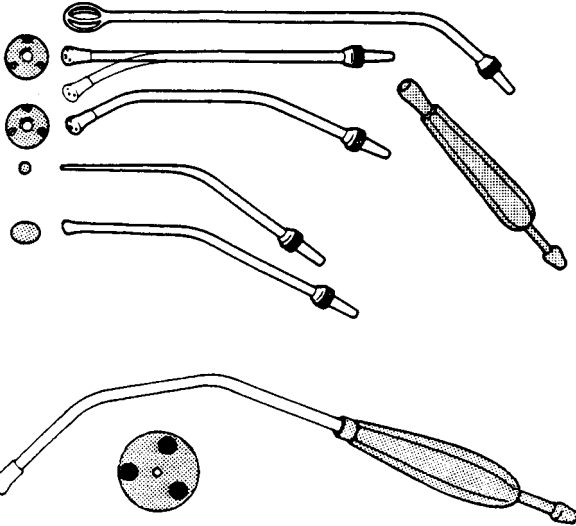
**Universal**

universal handle and 5 interchangeable ends
L2120-50 abdominal suction tube, fenestrated tip
L2120-52 bent tube, oval open tip
L2120-54 bent tube, round open tip
L2120-56 malleable tube, perforated tip
L2120-58 Yankauer tube, perforated tip
L2120-60 universal handle
L2120-65 complete set

Yankauer

chrome plated
L2125-30 305mm
L2125-32 spare rose

Suture Forceps

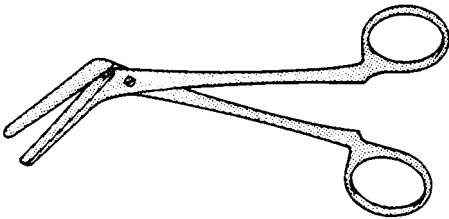
**Guy's**

angled flat blades, screw joint
L2130-15 150mm

Swab Carrier

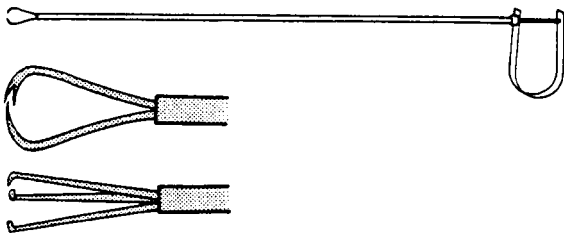
**Spring**

L2133-02 2 prong
L2133-03 3 prong

Tissue Forceps

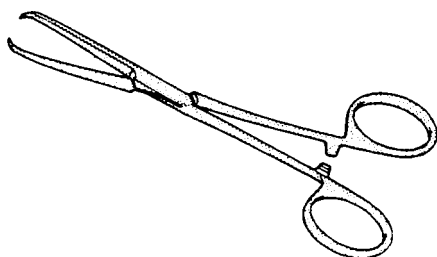
**Allis**

150mm
L2135-34 3/4 teeth
L2135-45 4/5 teeth
L2135-56 5/6 teeth
L2135-67 6/7 teeth

Tissue Forceps

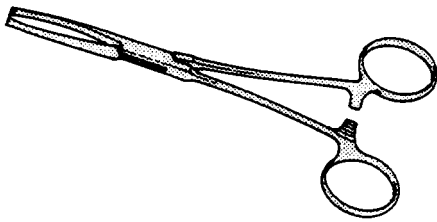
**Allis (American Pattern)**

160mm
L2140-34 3/4 teeth

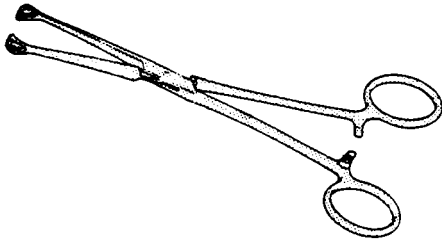
**Babcock**

serrated jaws
L2145-16 165mm
L2145-20 200mm
L2145-23 230mm

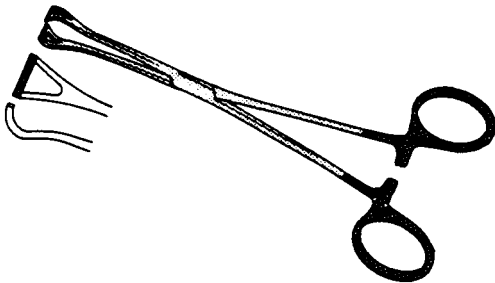
**Babcock**

tungsten carbide
L2150-16 160mm
L2150-20 200mm

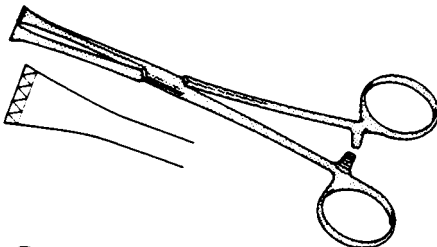
**Baby-Allis**

120mm
L2155-45 4/5 teeth

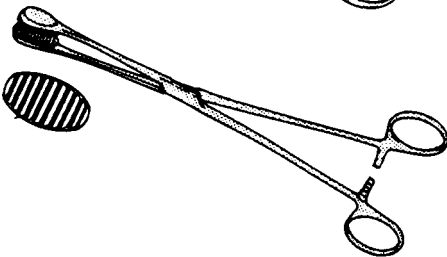
**Child**

L2160-24 240mm

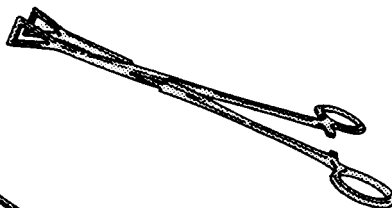
**Duval**

serrated
L2165-19 190mm, 13mm jaws

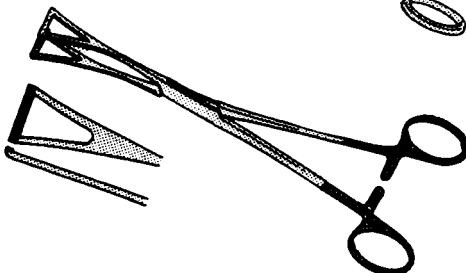
**Duval**

tungsten carbide
L2170-20 200mm, 13mm jaws

Tissue Forceps

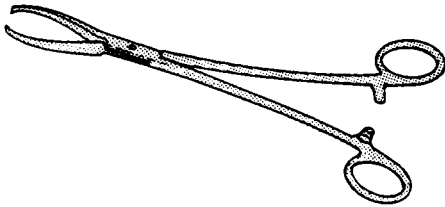
**Judd-Allis**

195mm
L2175-34 3/4 teeth

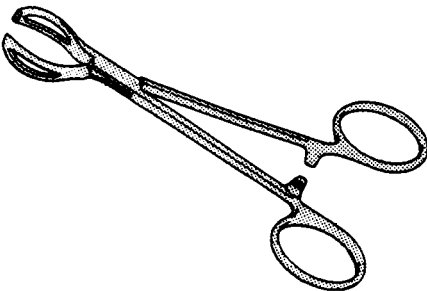
**Lanes**

1/2 teeth fenestrated
L2180-12 125mm
L2180-15 150mm
L2180-19 195mm

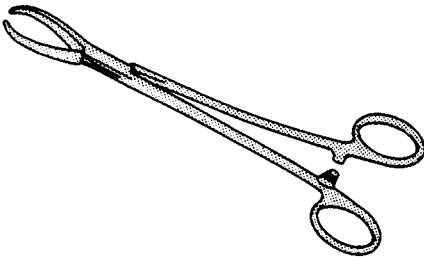
**Littlewood**

2/3 teeth
L2185-19 190mm

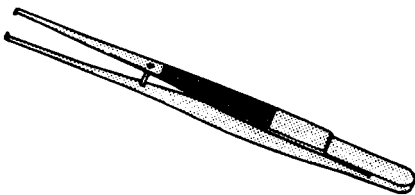
**Potts-Smith**

straight, 1/2 teeth
L2190-17 175mm
L2190-21 210mm
L2190-25 250mm

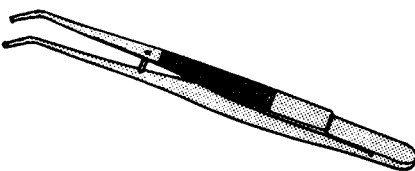
**Potts-Smith**

curved, 1/2 teeth
L2191-17 175mm
L2191-21 210mm
L2191-25 250mm

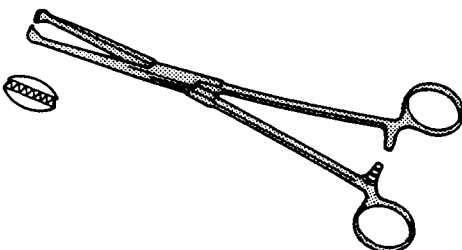
**Stile**

6/7 teeth
L2193-20 200mm

Tongue Forceps

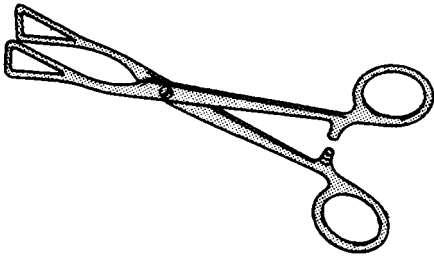
**Guy's**

screw joint

L2195-17 adult, 175mm

L2195-13 child, 130mm

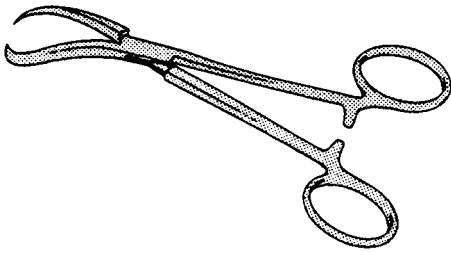
**Mayo**

L2200-14 140mm

Towel Clips

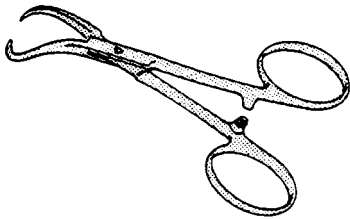
**Backhaus**

L2210-09 90mm

L2210-10 100mm

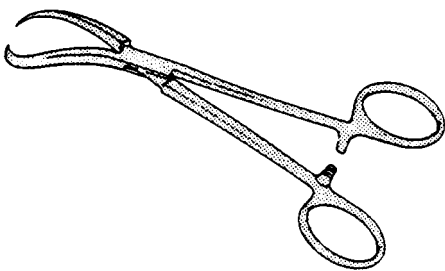
**Backhaus**

L2210-12 125mm

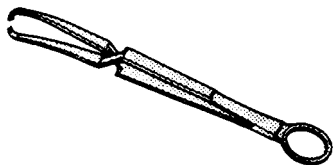
**Doyen**

L2215-17 175mm

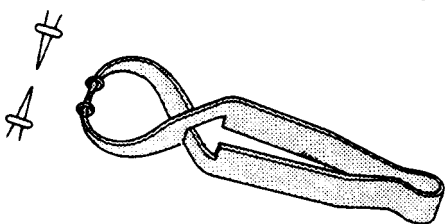
**Frenchay**

cross action, non-penetrating

L2220-09 90mm

Towel Clips

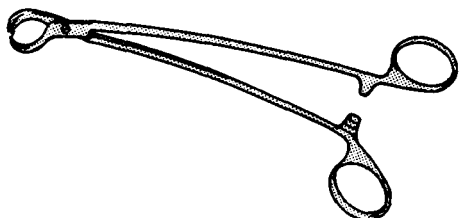
**Moynihan**

double tetra, screw joint
L2225-19 190mm

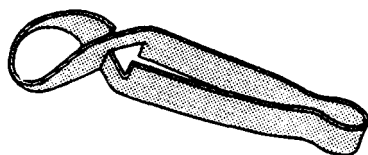
**Shardle**

cross action
L2230-09 90mm

Trocars

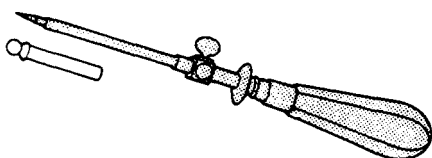
**Ascites**

with mount
L2235-16 16fg
L2235-21 21fg

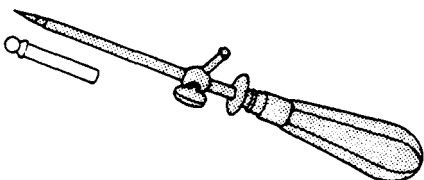
**Ascites**

with mount and stopcock
L2236-16 16fg
L2236-21 21fg

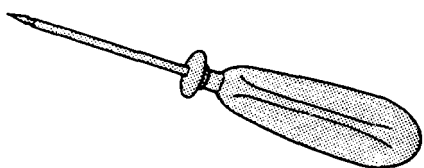
**Hydrocele**

L2240-07 7.5fg
L2240-08 8fg
L2240-09 9fg
L2240-30 set of 3 in pencil case

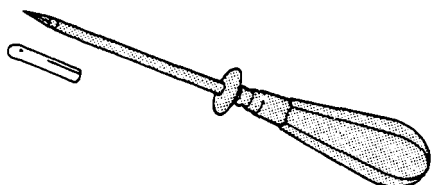
**Nelson**

L2245-10 10fg
L2245-23 23fg
L2245-27 27fg
L2245-28 28fg
L2245-32 32fg
L2245-33 33fg

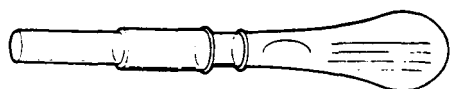
**Nested**

nickel silver cannulae, 170mm

L2250-02 2 Eg
L2250-05 5 Eg
L2250-08 8 Eg
L2250-11 11 Eg
L2250-40 set of 4 in metal case

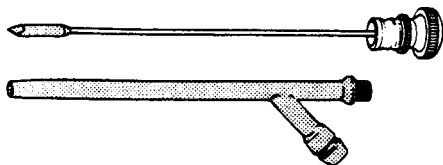

Trocars

**Oschner Gall Bladder**

with side suction connector
L2255-04 4.5 mm diameter, 235mm
L2255-06 6mm diameter, 240mm

Vein Strippers

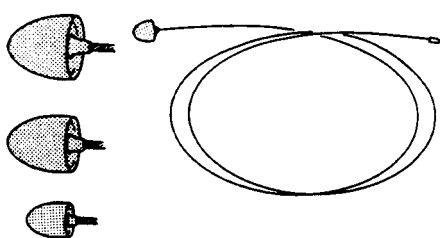
**Myer**

length 890mm
L2258-06 6mm
L2258-10 10mm
L2258-13 13mm
L2258-20 handle

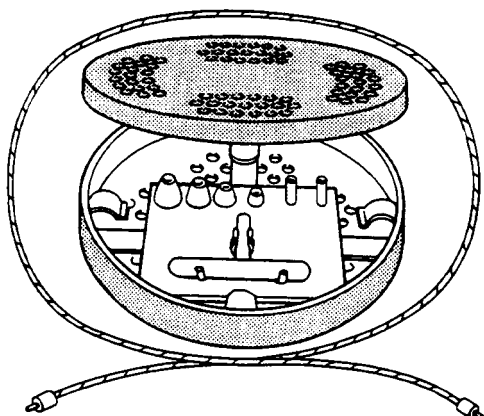
**Nabatoff**

4 acorn ends and 900mm 16 slug cable, 2 cylindrical tips and 'T' handle all in stainless steel case
L2260-02 complete set
L2260-06 spare acorn 6mm
L2260-09 spare acorn 9mm
L2260-12 spare acorn 12mm
L2260-15 spare acorn 15mm
L2260-16 spare cable 900mm 16 slug

Holloware

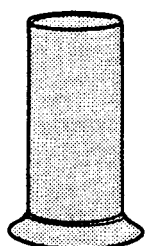
**Forceps Jar**

stainless steel, diameter height:
L2270-05 50mm 100mm
L2270-07 75mm 175mm
L2270-10 100mm 200mm

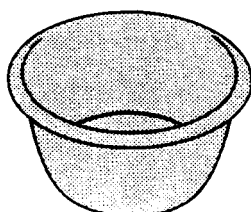
**Gallipot**

stainless steel, capacity, diameter depth:
L2273-06 55ml, 52mm 34mm
L2273-11 110ml, 64mm 44mm
L2273-17 170ml, 71 mm 45mm
L2273-28 280ml, 83mm 55mm

Holloware

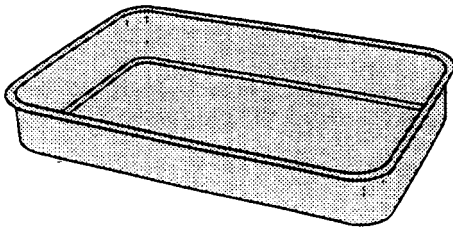
**Instrument Tray**

stainless steel, length width depth:

- L2275-21** 210mm 150mm 40mm
- L2275-24** 240mm 180mm 40mm
- L2275-30** 300mm 240mm x 40mm
- L2275-33** 330mm 270mm 40mm
- L2275-36** 360mm 300mm 40mm

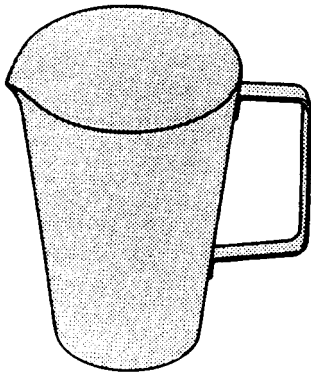
**Jug, Graduated**

stainless steel, capacity, diameter height:

- L2278-25** 250ml, 83mm 97mm
- L2278-50** 500ml, 95mm 115mm
- L2278-90** 1000ml, 127mm 136mm

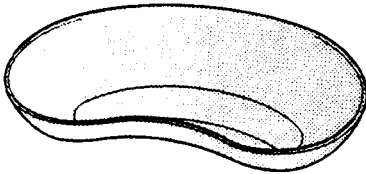
**Kidney Dish**

stainless steel, length width depth

- L2281-17** 173mm 93mm 35mm
- L2281-20** 206mm 94mm 42mm
- L2281-25** 254mm 115mm 52mm
- L2281-30** 307mm 144mm 60mm

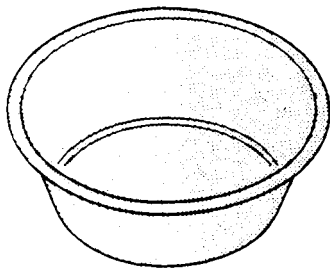
**Lotion Bowl**

stainless steel, capacity, diameter depth

- L2285-02** 240ml, 105mm 45mm
- L2285-07** 700ml, 150mm 60mm
- L2285-20** 2000ml, 210mm 90mm
- L2285-45** 4500ml, 270mm 105mm
- L2285-65** 6500ml, 300mm 120mm

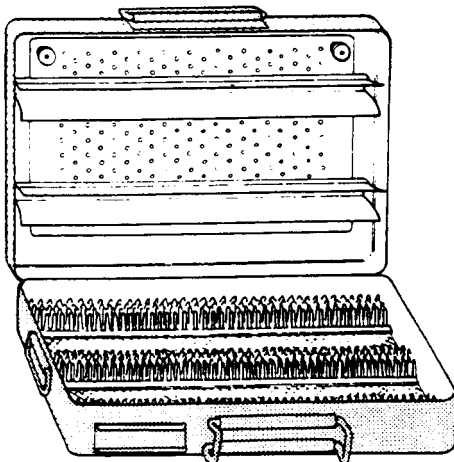
**Instrument Case**

stainless steel with silicon liner, length width height:

- L2290-20** 200mm 140mm 65mm
- L2290-30** 400mm 100mm 65mm
- L2290-40** 400mm 150mm 65mm
- L2290-50** 280mm 195mm 65mm
- L2290-60** 265mm 255mm 65mm
- L2290-70** 370mm 190mm 65mm
- L2290-80** 380mm 260mm 65mm

Laparoscopes

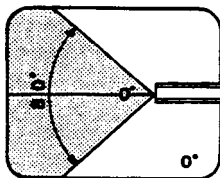
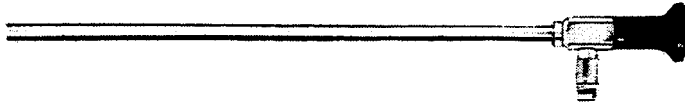
**Laparoscope**

direct vision 0°

L0360-0500 5mm

L0360-1000 10mm

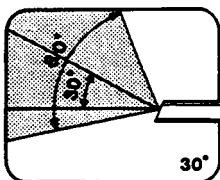
**Laparoscope**

foroblique vision 30°

L0360-0530 5mm

L0360-1030 10mm

Trocar Sheaths, Trocars

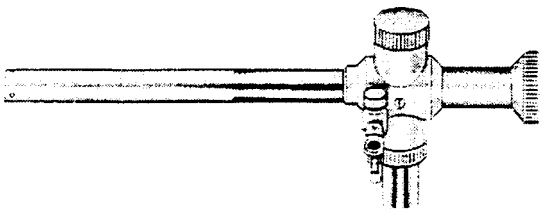
**Trocar Sheaths**

with trumpet valve and stopcock, 100mm

L0361-0001 5mm

L0361-0002 10mm

L0361-0003 11mm

L0361-0004 15mm

L0361-0005 20mm

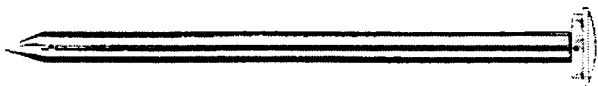
**Trocars**

with conical points

L0361-0101 5mm

L0361-0102 10mm

L0361-0103 11mm

L0361-0104 15mm

L0361-0105 20mm

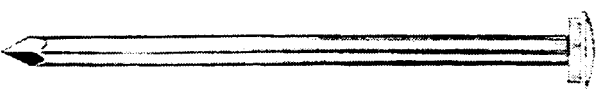
**Trocars**

with pyramidal points

L0361-0401 5mm

L0361-0402 10mm

L0361-0403 11mm

L0361-0404 15mm

L0361-0405 20mm

Trocars, Reducer Sleeves, Insufflation Needles

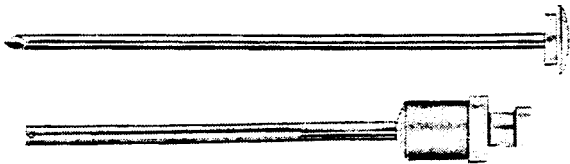

Special Trocar

automatic
L0361-1001 5mm
L0361-1002 10mm



Appendix Extractor and Reducer Sleeve

L0361-3001 10mm-> 5mm
L0361-3002 11mm-> 5mm
L0361-3003 15mm-> 5mm
L0361-3004 20mm-> 5mm
L0361-3005 15mm-> 10mm
L0361-3006 20mm-> 10mm



Applicator for Endo-Ligature

L0361-3201 4.5mm° x 110mm



Insufflation Needle

Veress
L0361-4005 55mm
L0361-4010 100mm
L0361-4012 120mm
L0361-4015 150mm

Dilation Set, Suction and Irrigation Tubes

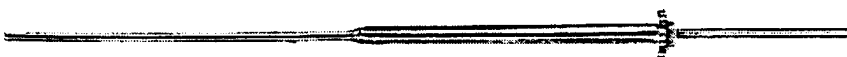

Dilation Set

consisting of dilator sleeve and dilator
L0361-4501 5mm-> 10mm
L0361-4502 5mm-> 15mm
L0361-4503 10mm-> 15mm
L0361-4504 5mm-> 20mm
L0361-4505 10mm-> 20mm



Suction Tube

with Luer Lock connection, 5mm
L0361-4301



two way stopcock
L0361-4350

Suction and Irrigation Tubes,
Palpation Probes



Suction and Irrigation Tubes
with Laser tube 40cm, 5mm
L0361-4807
without Laser tube 40cm, 5mm
L0361-4608



Palpation Probe
5mm, 30cm
L0361-5001



**Injection and Puncture Needle
with Irrigation**
30mm, 5mm diameter
L0361-5012

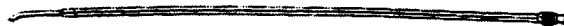

Cholangiogram Guide
L0361-5012



Suction Coagulators, Insulated



Suction Coagulator
5mm, 33cm
L0362-0001



Suction Coagulator
with spatula tip, 5mm, 33cm
L0362-0002



Suction Coagulator
with hook end, 5mm, 33cm
L0362-0003



Suction Coagulator
with hook end, 5mm, 33cm
L0362-0004



Electrodes, fully insulated

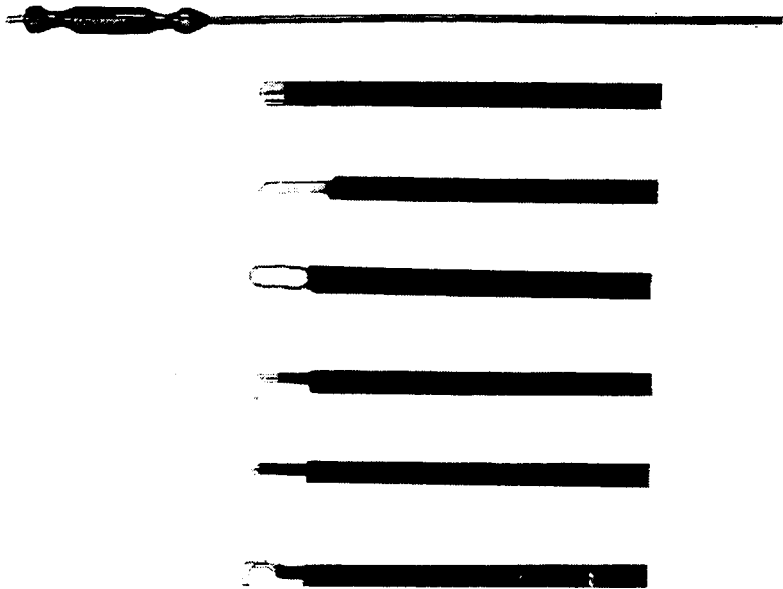

Button tip electrode
L0362-0202

Knife tip electrode
L0362-0203

Loop tip electrode
L0362-0204

Dissecting hook electrode, standard
L0362-0205

Dissecting hook electrode, small
L0362-0206

Dissecting hook electrode, large
L0362-0207

Cholangiogram Clamp,
Clip Applying Forceps

Cholangiogram Clamp
with ratchet, 33cm
L0365-0001

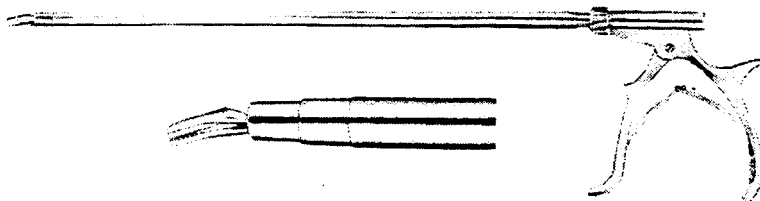

Cholangiogram Clamp
with ratchet, 33cm
L0365-0010

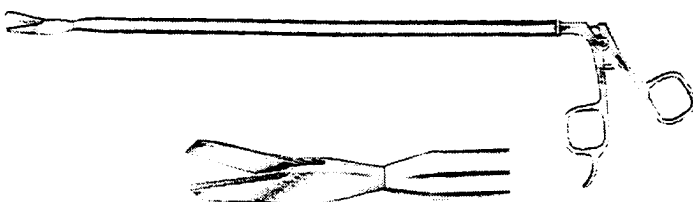
Scissors, Grasping Forceps,
Claw Forceps, 10mm

Scissors
1 serrated blade, 10mm, 33cm
L0365-1001

Scissors, Grasping Forceps,
Claw Forceps, 10mm

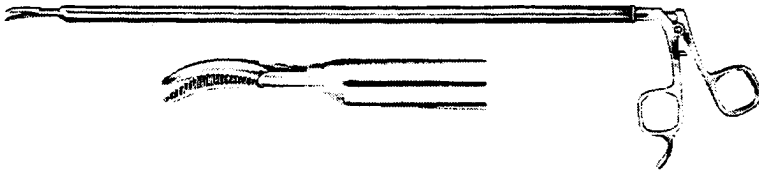

**Dissecting Forceps
Maryland**

10mm, 33cm
L0365-1005

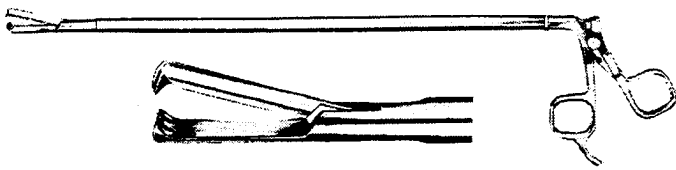

Claw Grasping Forceps

2 x 3 teeth, 10mm, 33cm
L0365-1010

Grasping Forceps,
Spoon Forceps, 10mm

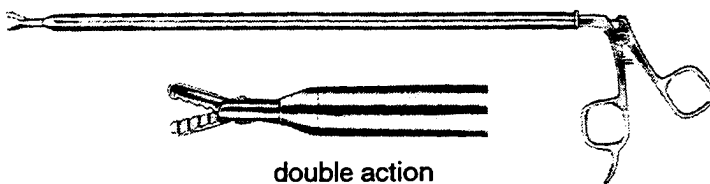

double action

Alligator Grasping Forceps

10mm, 33cm
L0365-1015

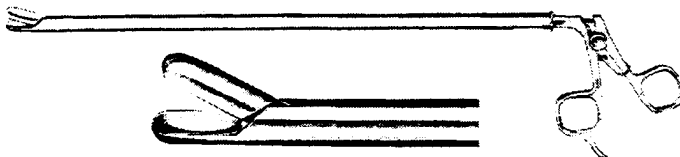

Stone Retrieval Forceps

10mm, 33cm
L0365-1020

Grasping Forceps

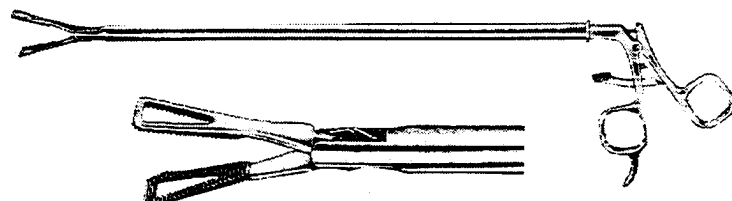

Pennington Grasping Forceps

34cm, without ratchet
L0365-1030

34cm, with ratchet
L0365-1031

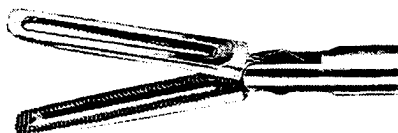

Grasping Forceps

fenestrated, 34cm, without ratchet
L0365-1032

fenestrated, 34cm, with ratchet
L0365-1033

Grasping Forceps, 10mm



double action

De Bakey-Allis Grasping Forceps

34cm, without ratchet
L0365-1040

34cm, with ratchet
L0365-1041

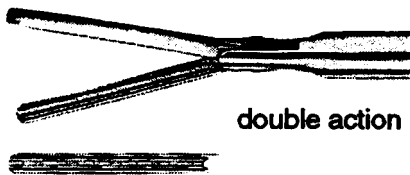

double action

De Bakey Grasping Forceps, 34cm

Length of jaw	without ratchet	with ratchet
30mm	L0365-1051	L0365-1055
40mm	L0365-1052	L0365-1056
50mm	L0365-1053	L0365-1057
60mm	L0365-1054	L0365-1058

Scissors, 5mm , insulated

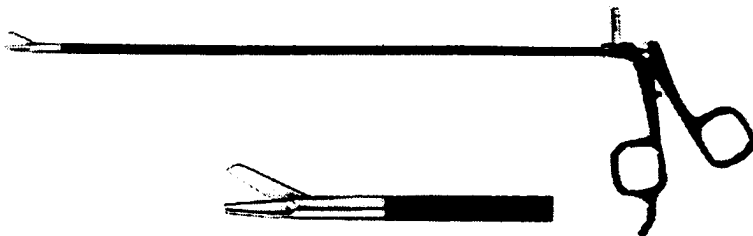

Peritoneal Scissors

serrated, 5mm, 33cm, insulated
L0365-1801



Hook Scissors

5mm, 33cm, insulated
L0365-1805



Ultra-Cut

Operating Scissors, 33cm, insulated, straight
L0365-1810



Operating Scissors, 33cm, insulated, curved
L0365-1811



Ultra-Cut

Metzenbaum, 33cm, insulated
L0365-1814



Claw Forceps, Grasping Forceps, 5mm

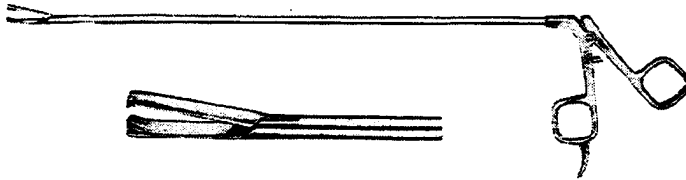

Claw Forceps
5mm, 33cm
L0365-2001

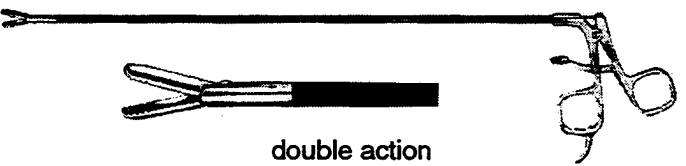

Grasping Forceps
with ratchet, 5mm, 33cm, insulated shaft
L0365-2110



double action

Grasping Forceps
with ratchet, 5mm, 33cm, insulated shaft
L0365-2111



double action

Grasping Forceps
with ratchet, 5mm, 33cm, insulated shaft
L0365-2115

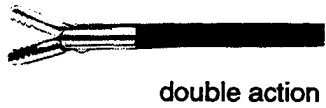

double action

Grasping Forceps
with ratchet, 5mm, 33cm, insulated shaft
L0365-2118

Grasping Forceps, insulated, 5mm

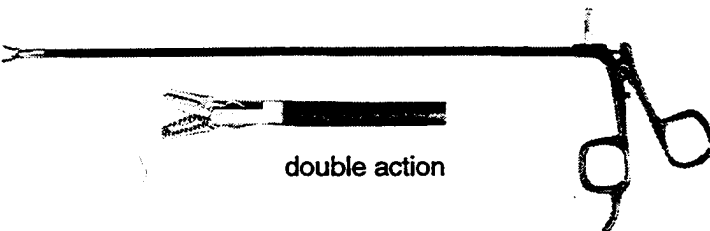

double action

Grasping Forceps
fenestrated, 33cm, without ratchet
L0365-2201

fenestrated, 33cm, with ratchet
L0365-2202

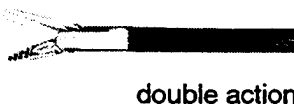

double action

Grasping forceps
33cm, without ratchet
L0365-2203

33cm, with ratchet
L0365-2204



Grasping Forceps,
insulated, 5mm



double action



double action

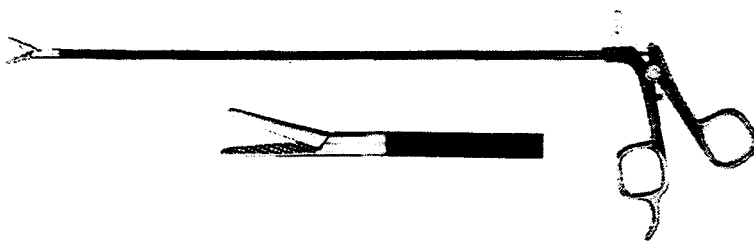

double action



Grasping Forceps

Cobra toothed, 33cm, without ratchet
L0365-2205

Cobra toothed, 33cm, with ratchet
L0365-2206

Grasping Forceps

33cm, without ratchet
L0365-2210

33cm, with ratchet
L0365-2211

Grasping Forceps

Atraumatic, 33cm, without ratchet
L0365-2214

Atraumatic, 33cm, with ratchet
L0365-2215

Grasping Forceps

fenestrated, 33cm, without ratchet
L0365-2220

fenestrated, 33cm, with ratchet
L0365-2221

Grasping Forceps

Delphin, 33cm, without ratchet
L0365-2224

Delphin, 33cm, with ratchet
L0365-2225

Grasping Forceps

Allis, 33cm, without ratchet
L0365-2230

Allis, 33cm, with ratchet
L0365-2231

Grasping Forceps,
with ratchet, 5mm

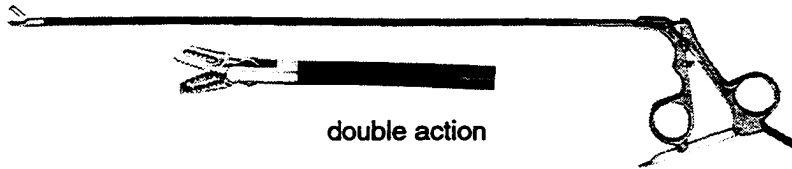

double action

Grasping Forceps
fenestrated, 33cm,
L0365-2402



double action

Grasping Forceps
Cobra toothed, 33cm
L0365-2406



Grasping Forceps
Atraumatic, 33cm
L0365-2415



Grasping Forceps
Allis, 33cm
L0365-2431

Scissors, Grasping Forceps,
insulated, 5mm

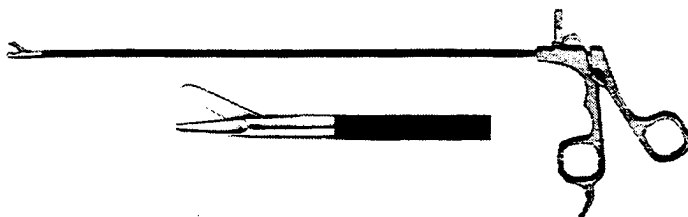

Peritoneal Scissors
serrated, 5mm, 33cm, insulated
L0365-2601



Hook Scissors
5mm, 33cm, insulated
L0365-2602



double action

Dissecting Forceps
33cm
L0365-2603



double action

Grasping Forceps
Cobra toothed, 33cm
L0365-2605



Grasping Forceps,
insulated, 5mm

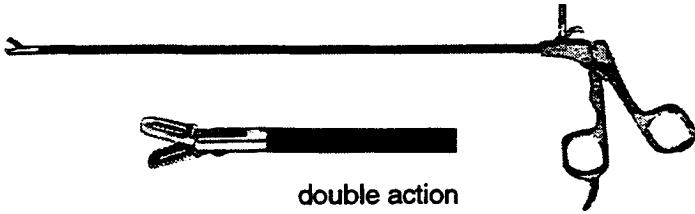

Grasping Forceps
fenestrated, 33cm
L0365-2606

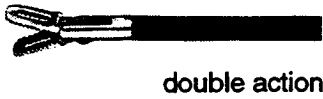

double action

Grasping Forceps
33cm
L0365-2610



double action

Grasping Forceps
33cm
L0365-2611



double action

Grasping Forceps
33cm
L0365-2612

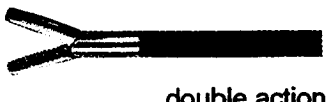

double action

Grasping Forceps
33cm
L0365-2615



double action

Grasping Forceps
33cm
L0365-2618



double action

Grasping Forceps
Atraumatic, 33cm
L0365-2619



Dissecting Forceps
fenestrated, 33cm
L0365-2620



double action

Grasping Forceps
Delphin, 33cm
L0365-2624



Grasping Forceps
Allis, 33cm
L0365-2630



Micro Forceps, Scissors,
Needle Holders

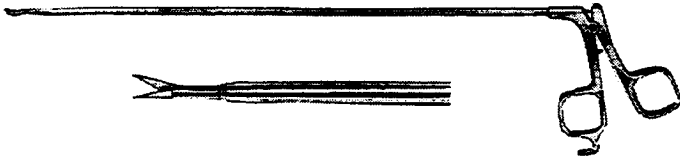

Micro Dissecting Scissors

5mm, 33cm, straight

L0365-3002

5mm, 33cm, curved left

L0365-3003

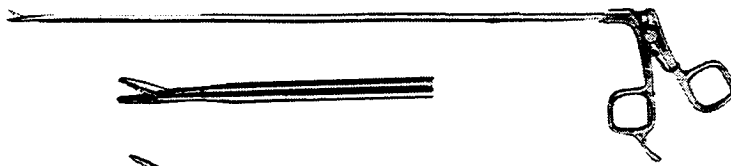

Micro Grasping Forceps

5mm, 33cm, straight

L0365-3101

5mm, 33cm, curved

L0365-3102



Micro Biopsy Forceps

5mm, 33cm

L0365-3105



Needle Holder

33cm, 5mm jaw

L0365-3201

33cm, 3mm jaw

L0365-3202

Grasping Instruments, 5mm

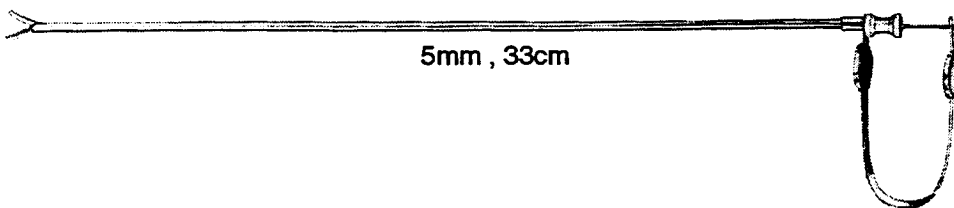

Bowel Forceps

L0365-6001



Grasping Forceps

L0365-6005



Grasping Forceps

strong pattern

L0365-6006

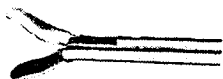

Grasping Forceps

strong pattern

L0365-6007

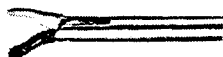

Grasping Instruments, 5mm

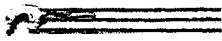

Forceps
for suturing
L0365-6012

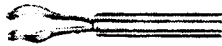

Grasping Forceps
Atraumatic
L0365-6020



Micro Grasping Forceps
Straight
L0365-6030

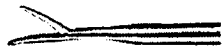

Micro Grasping Forceps
Curved
L0365-6031

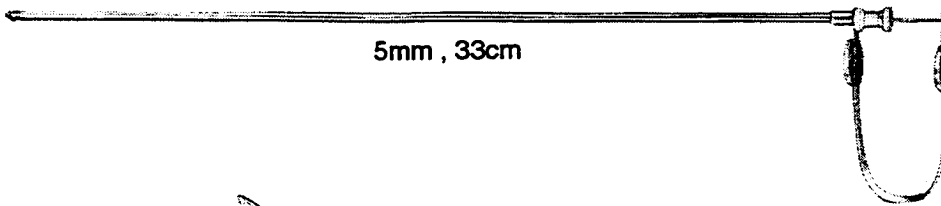

5mm , 33cm

Dissecting Forceps
L0365-6035

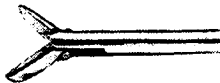

Grasping Forceps
L0365-6038

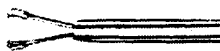

Grasping Forceps
Atraumatic
L0365-6039

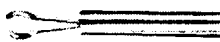

Grasping Forceps
Atraumatic, strong pattern
L0365-6040

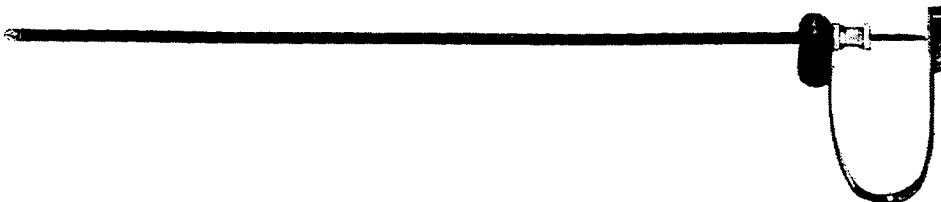
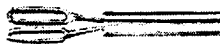

Grasping Forceps
Atraumatic, insulated
L0365-6139



Grasping Forceps
Atraumatic, strong pattern,
insulated
L0365-6140

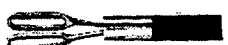

THORACIC SURGERY

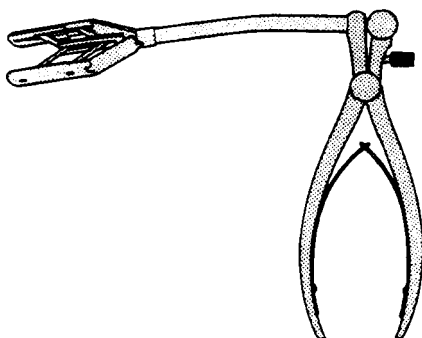

Aortic Dilators

**Tubbs**

L2502-08 blade opening 8mm to 42mm

Artery Clamps

**Blalock**

small

L2515-21 215mm

**Blalock**

medium

L2515-22 220mm

**Blalock**

large

L2515-22 225mm

Artery Forceps

**Roberts**

curved on flat, box joint

L2525-23 230mm

curved on flat, screw joint

L2526-23 230mm

Biopsy Punch

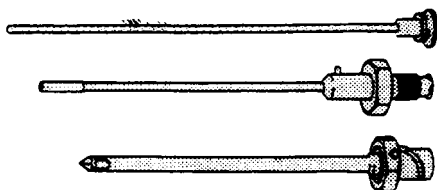
**Abrams Pleural**

length 125mm

L2535-04 4mm

Clamps

**Blalock**

cross action, straight

L2545-11 11mm jaw 38mm

L2545-14 14mm jaw 48mm

L2545-17 17mm jaw 60mm

L2545-27 27mm jaw 70mm

L2545-38 38mm jaw 79mm

**Blalock**

cross action, curved

L2546-11 11mm jaw 38mm

L2546-14 14mm jaw 48mm

L2546-17 17mm jaw 60mm

L2546-27 27mm jaw 70mm

L2546-38 38mm jaw 79mm

Clamps

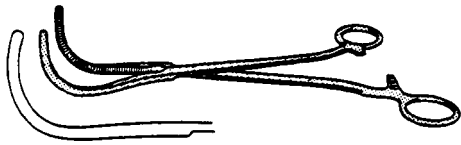

Crafoord
full curve
L2555-22 220mm

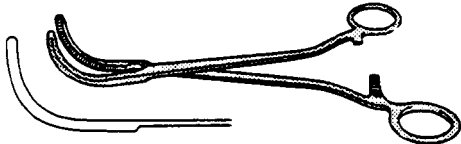

Crafoord
medium curve
L2555-23 220mm



Crafoord
slight curve
L2555-19 190mm

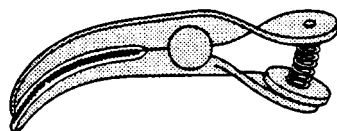
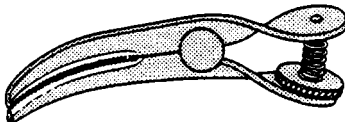
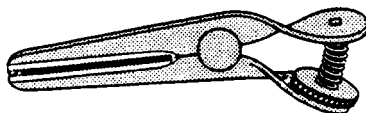

Potts Bulldog
cross action
L2560-01 straight
L2560-02 slight curve
L2560-03 acute curve

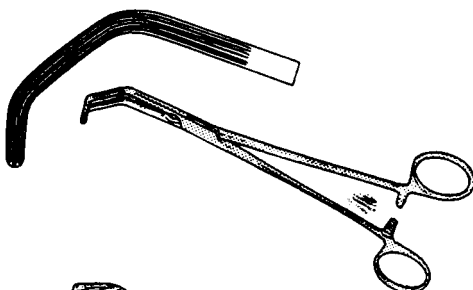

Price Thomas Bronchus
double angle, longitudinal serrations
L2570-22 220mm

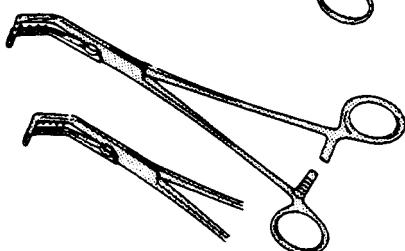

Price Thomas Bronchus
double angle, with spikes
L2571-22 220mm, left
L2571-23 220mm, right

Clamps

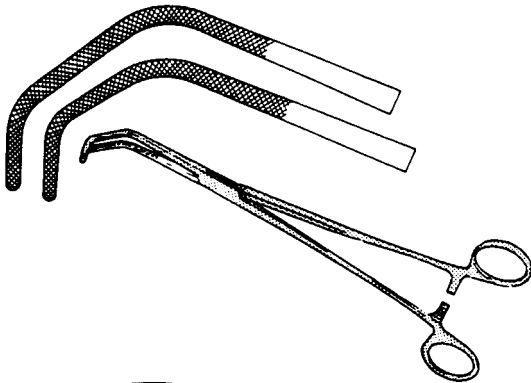
**Satinsky**

double angle, cross serrated jaws

L2580-26 deep angle, 265

L2580-27 slight angle, 265mm

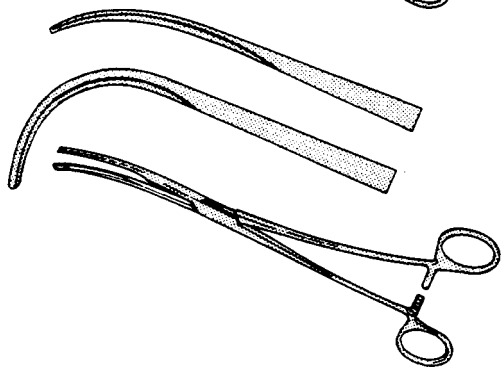
**Semb**

slight curve

L2585-24 240mm

deep curve

L2585-25 240mm

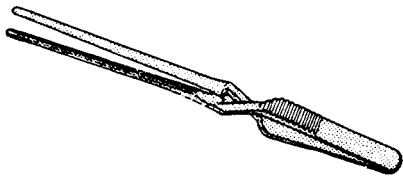
**Bulldog**

cross action

L2595-07 75mm

L2595-08 85mm

L2595-10 105mm

L2595-12 120mm

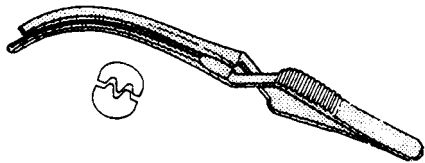
**Bulldog**

cross action, curved

L2596-07 75mm

L2596-08 85mm

L2596-10 105mm

L2596-12 120mm

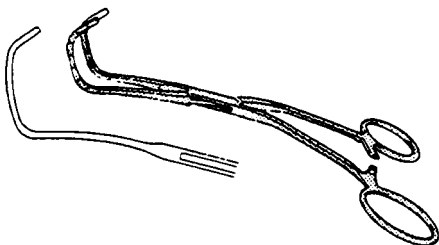
**Cooley Derra**

slightly curved shanks, large jaws, calibrated in 5mm sections

L2605-17 170mm

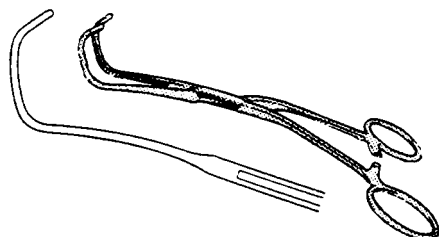
**Cooley Derra**

slightly curved shanks, medium jaws, calibrated in 5mm sections

L2605-16 165mm

Clamps, Atraumatic

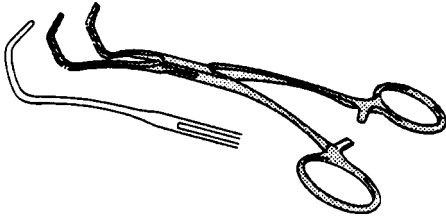
**Cooley Derra**

slightly curved shanks, small jaws, calibrated in 5mm sections
L2605-15 160mm

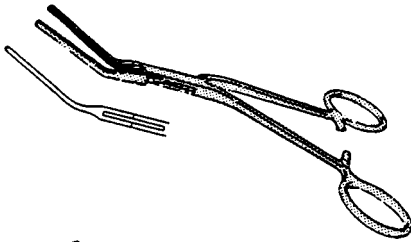
**Cooley Multipurpose**

angled jaws 30°, angled shanks
L2610-16 160mm

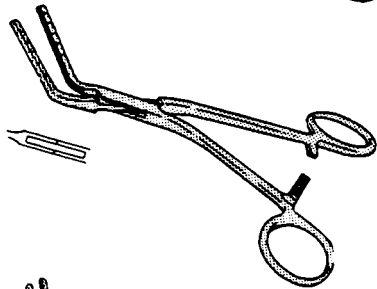
**Cooley Multipurpose**

angled jaws 60°, angled shanks
L2610-17 160mm

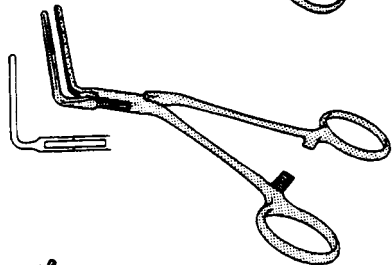
**Cooley Multipurpose**

angled jaws 90°, angled shanks
L2610-17 160mm

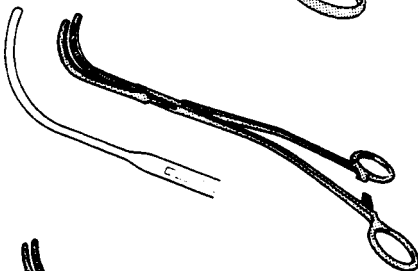
**DeBakey**

acute curve, 1/2 serrations, 60mm jaw
L2620-24 245mm

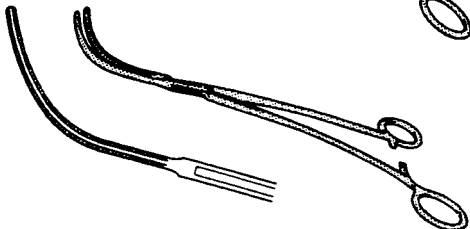
**DeBakey**

medium curve, 1/2 serrations, 65mm jaw
L2620-25 250mm

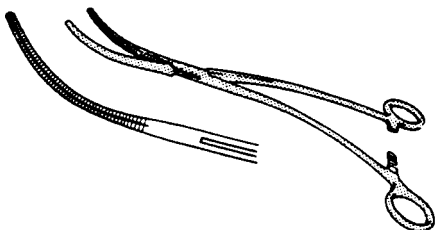
**DeBakey**

slight curve, 1/2 serration, 75mm jaw
L2620-26 265mm

Clamps, Atraumatic

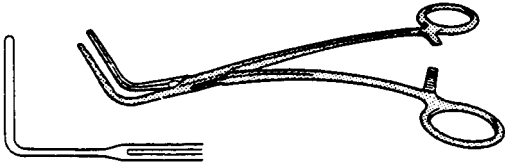

DeBakey Multipurpose
right angled, 1/2 serrations, 40mm jaw
L2625-22 220mm

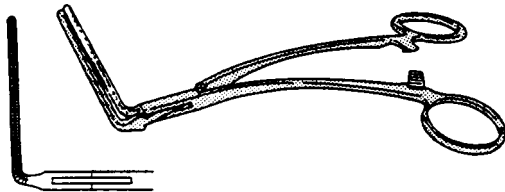

DeBakey Multipurpose
right angled, 1/2 serrations, 50mm jaw
L2625-20 200mm

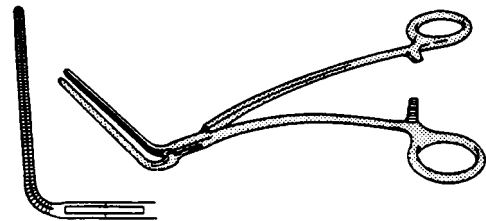

DeBakey Multipurpose
right angled, 1/2 serrations, 65mm jaw
L2625-21 215mm

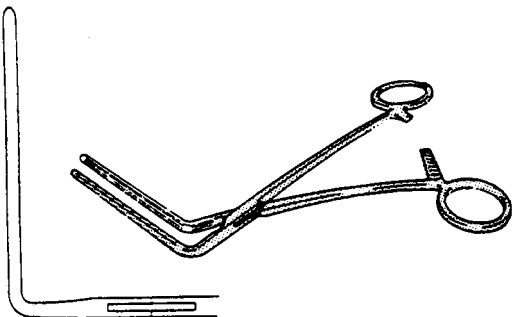

DeBakey Multipurpose
right angled, 1/2 serrations, 100mm jaw
L2625-28 280mm



DeBakey Multipurpose
obtuse angle, 1/2 serrations, 50mm jaw
L2626-21 210mm
obtuse angle, 1/2 serrations, 40mm jaw
L2626-23 235mm

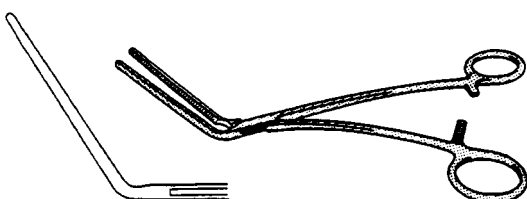

DeBakey Multipurpose
obtuse angle, 1/2 serrations, 65mm jaw
L2626-24 240mm
obtuse angle, 1/2 serrations, 100mm jaw
L2626-30 300mm

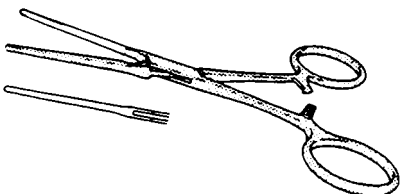

DeBakey Ring Handle
straight, 1/2 serrations, 45mm jaw
L2630-13 130mm

Clamps, Atraumatic

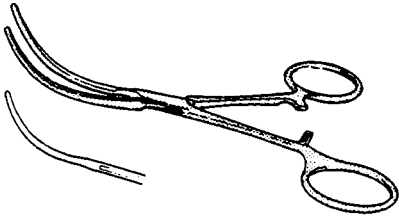
**DeBakey Ring Handle**

curved, 1/2 serrations, 45mm jaw
L2631-13 130mm

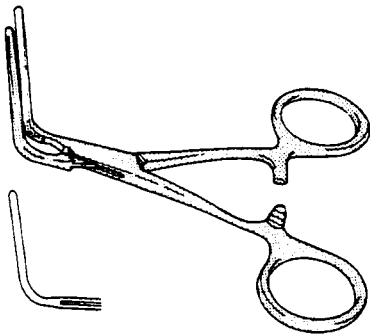
**DeBakey Ring Handle**

right angled, 1/2 serrations, 40mm jaw
L2632-12 120mm

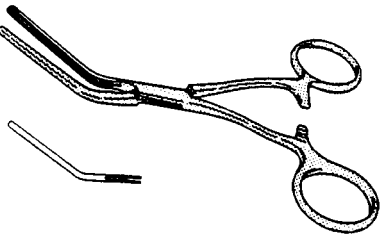
**DeBakey Ring Handle**

angled, 1/2 serrations, 40mm jaw
L2633-11 115mm

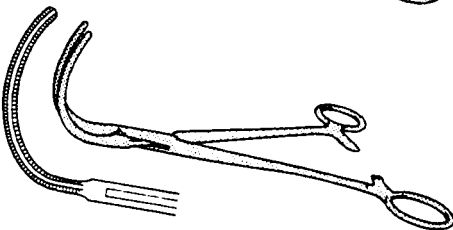
**Glover**

curved, 1/2 serrations, 3mm right angled jaw, 32mm radius
L2645-18 185mm

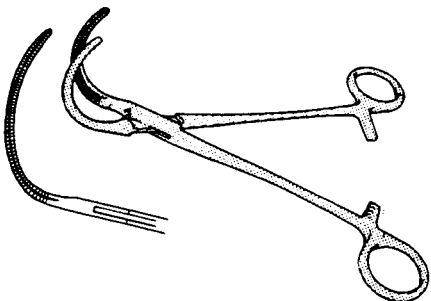
**Glover**

curved, 1/2 serrations, 3mm right angled jaw, 35mm radius
L2645-20 200mm

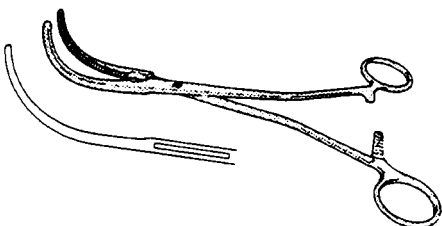
**Glover**

curved, 1/2 serrations, 3mm shallow jaw, 32mm radius
L2645-21 210mm

Clamps, Atraumatic

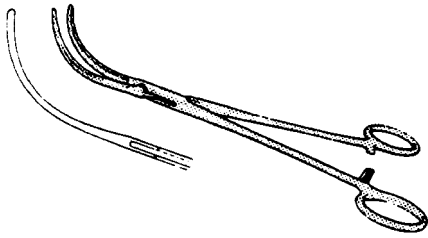
**Glover**

curved, 1/2 serrations, 3mm shallow jaw, 35mm radius
L2645-24 240mm

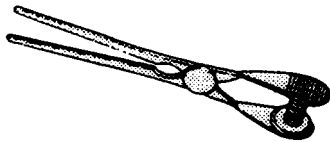
**Glover Bulldog**

straight
L2655-06 60mm
L2655-07 70mm
L2655-09 90mm
L2655-11 110mm

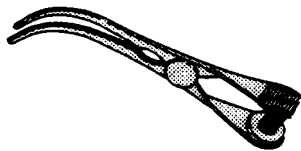
**Glover Bulldog**

curved
L2656-06 60mm
L2656-07 70mm
L2656-09 90mm
L2656-11 110mm

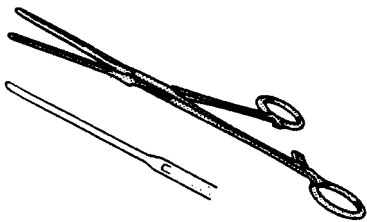
**Glover Coarctation**

straight, 1/2 serrations, 55mm jaw
L2660-22 220mm
 straight, 1/2 serrations, 70mm jaw
L2660-25 250mm

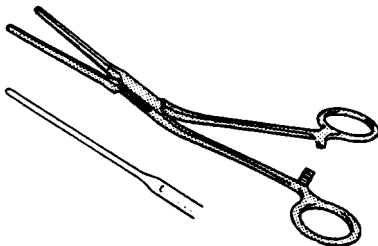
**Glover Coarctation**

angled shanks, 1/2 serrations, 55mm jaw
L2661-22 220mm
 angled shanks, 1/2 serrations, 70mm jaw
L2661-25 250mm

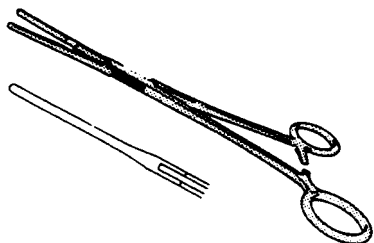
**Glover Ductus**

straight, 1/2 serrations, 30mm jaw
L2665-20 200mm

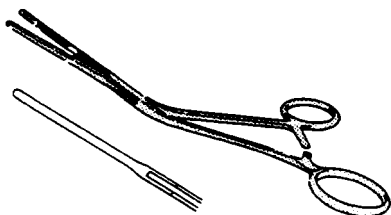
**Glover Ductus**

angled shanks, 1/2 serrations, 30mm jaw
L2666-20 200mm

Clamps, Atraumatic

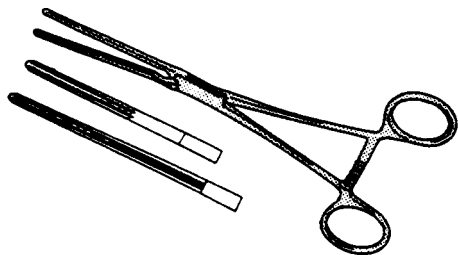
**Potts straight**

L2675-21 210mm

L2675-22 220mm

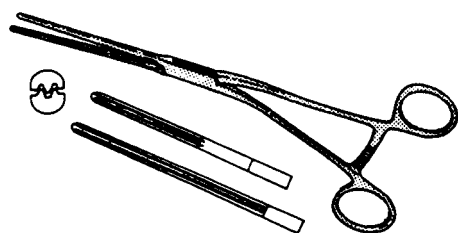
**Potts**

angled shanks

L2676-21 210mm

L2676-22 220mm

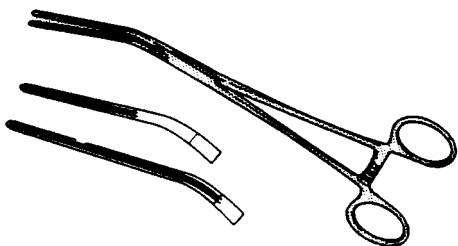
**Potts**

angled on flat

L2677-21 210mm

L2677-22 220mm

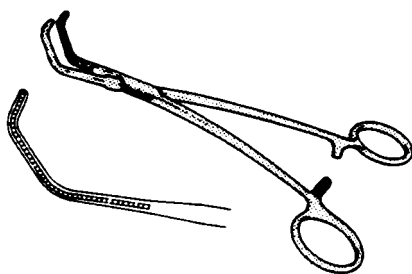
**Satinsky**

double angled, 1/2 serrations, small, 32mm jaw

L2685-25 250mm

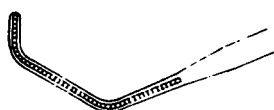
**Satinsky**

double angle, 1/2 serrations, medium, 40mm jaw

L2685-26 250mm

**Satinsky**

double angle, 1/2 serrations, large, 50mm jaw

L2685-27 250mm

Costotomes

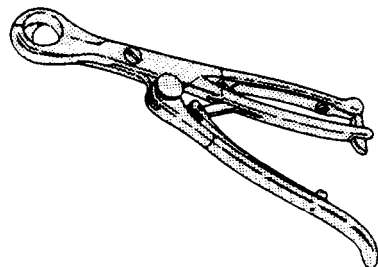

Vehmehren
L2695-24 240mm

Dissecting Forceps

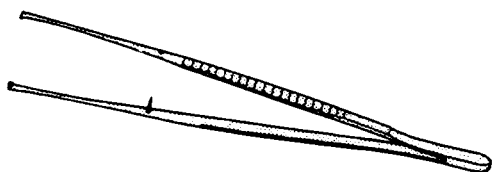

Nelson
fine teeth
L2700-23 230mm

Elevators

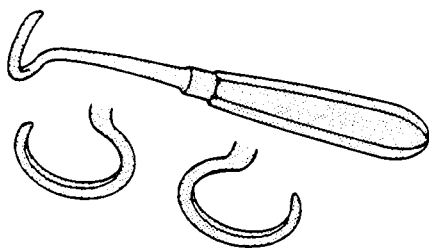

Doyen Periosteal
adult, 165mm
L2703-01 left
L2703-02 right
child
L2704-01 left
L2704-02 right

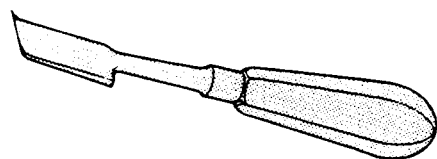

Tudor Edwards Periosteal
length 175mm
L2705-12 12mm
L2705-18 18mm

Endarterectomy

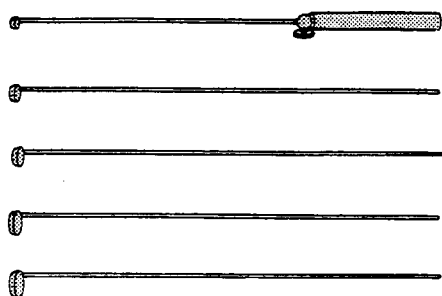

Cannon
sharp, length 250mm
L2715-06 6mm
L2715-08 8mm
L2715-10 10mm
L2715-12 12mm
L2715-14 14mm
L2715-15 set of 5

Lung Forceps



Duval
25mm blade
L2725-22 220mm



Mayo
fenestrated
L2730-22 225mm

Raspatories



Semb
short shaft, notched end
L2740-20 200mm



Semb
long shaft, notched end
L2740-23 235mm

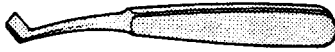

Semb
short shaft, straight end
L2740-19 190mm
long shaft, straight end
L2740-25 250mm



Semb
short shaft, oval end
L2740-26 220mm
short shaft, oval end angled
L2740-27 195mm



Semb
long shaft
L2740-28 250mm



Semb
chisel end
L2740-29 200mm

Retractors

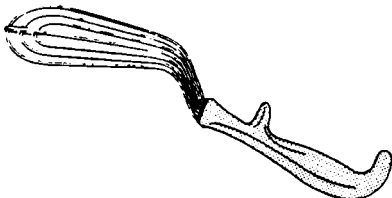

Allison Lung
Adult
L2750-30 300mm
child
L2750-28 280mm
infant
L2750-27 280mm

Retractors

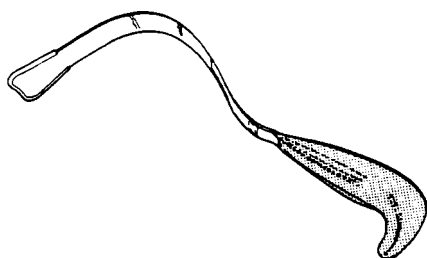
**Harrington**

L2760-45 320mm, 45mm 125mm blade

L2760-62 320mm, 62mm 125mm blade

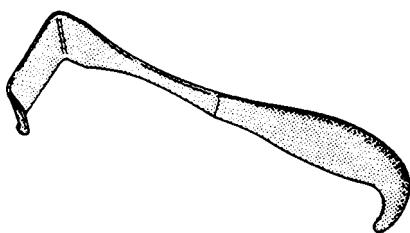
**Tudor Edwards**

L2770-25 200mm, 25mm blade

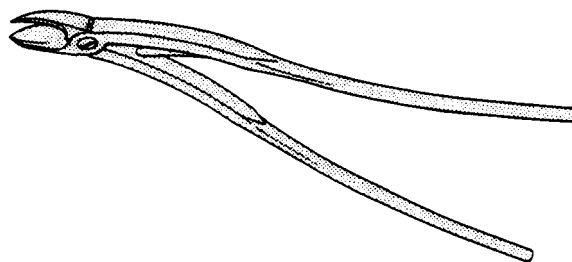
**Bethune**

L2780-34 340mm

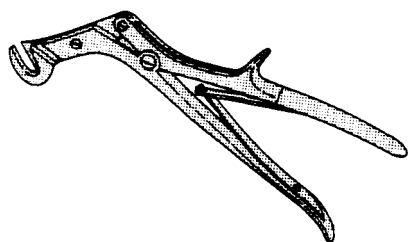
**Giertz**

L2785-27 270mm

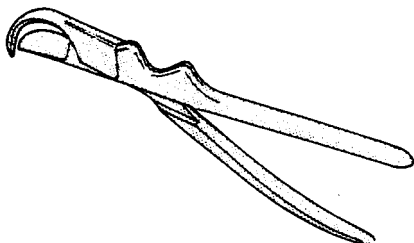
**Gluck**

L2790-22 220mm

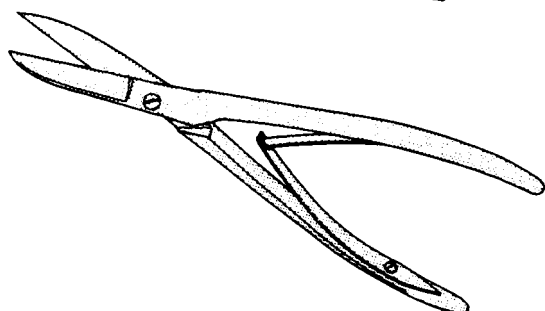
**Scissor Type**

L2795-23 230mm

Rib Shears

Rib Shears

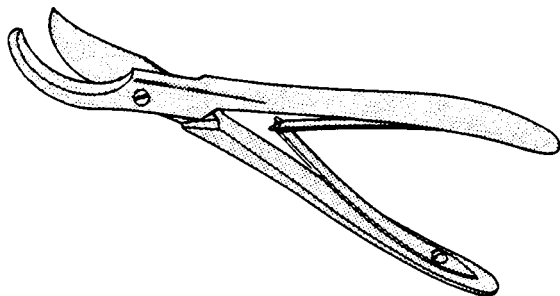

Spring, Curved
L2800-22 220mm

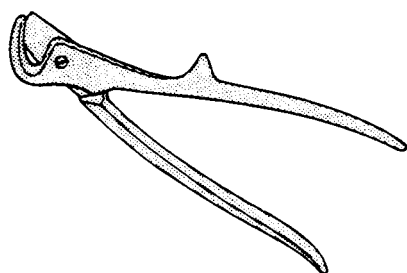

Stille
L2805-21 210mm

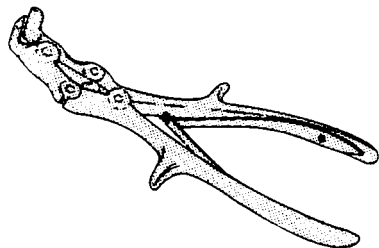

Tudor Edwards
compound action, anterior
L2810-23 235mm

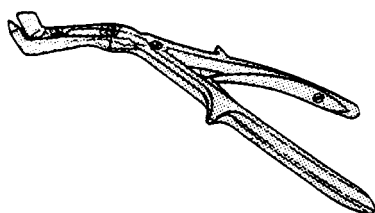

Tudor Edwards
compound action, posterior
L2811-25 250mm

Rib Spreaders

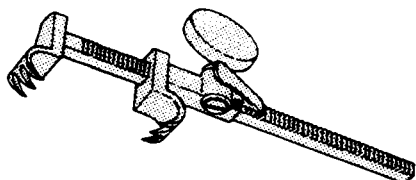

Bailey
L2820-16 160mm

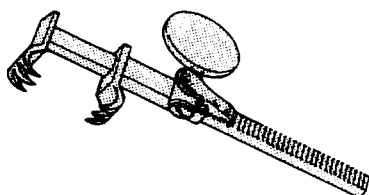

Bailey Baby
L2821-14 140mm

Rib Spreaders

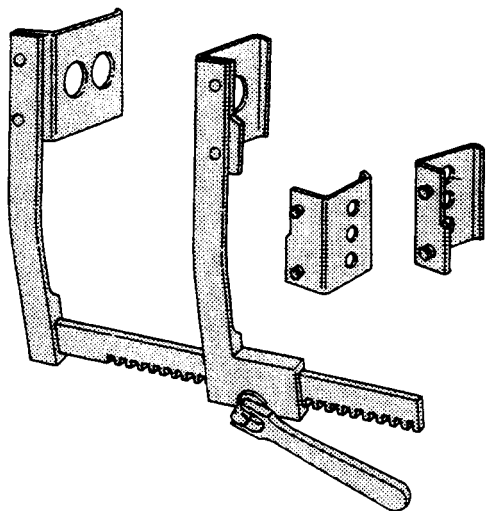
**Burford**

with 2 pairs of interchangeable blades

L2830-20 200mm, 80mm 67mm and 40mm 67mm blades

L2830-25 250mm, 80mm 67mm and 40mm 67mm blades

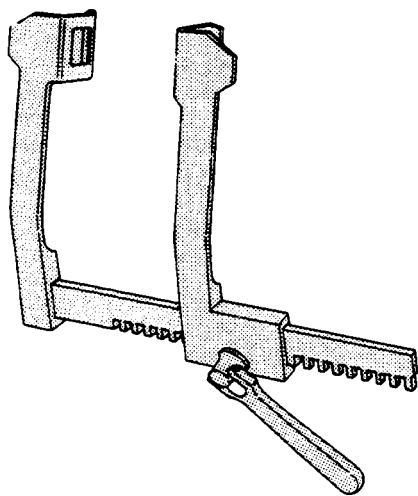
**Finocchietto**

L2840-16 165mm, 36mm 45mm blade

L2840-18 200mm, 36mm 45mm blade

L2840-19 200mm, 44mm 65mm blade

L2840-21 200mm, 65mm 65mm blade

L2840-24 250mm, 44mm 65mm blade

L2840-26 250mm, 65mm 65mm blade

L2840-30 300mm, 44mm 65mm blade

L2840-31 300mm, 65mm 65mm blade

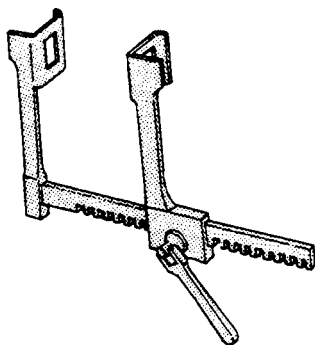
**Finocchietto Baby**

L2841-10 105mm, 18mm 21 mm blade

Rib Spreaders

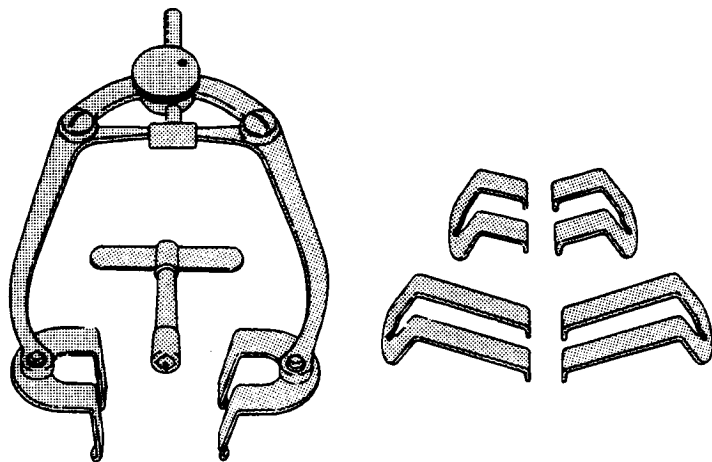
**Price Thomas**

complete with 3 sets of blades
 L2850-25 250mm 215mm 68mm

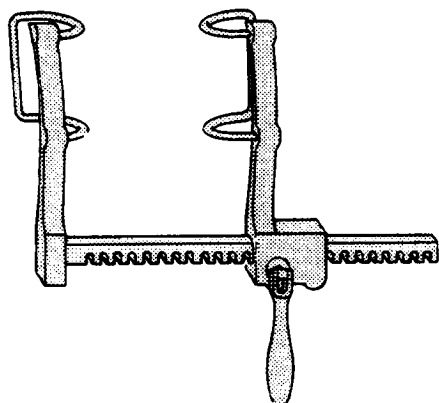
**Ronald Edwards**

curved arms, fenestrated blades
 L2855-10 100mm, 25mm 30mm blades
 L2855-15 150mm, 30mm 50mm blades
 L2855-24 245mm, 65mm 75mm blades

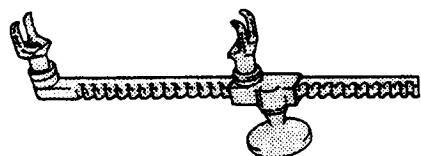
**Sellors**

approximator combined
 L2860-20 200mm

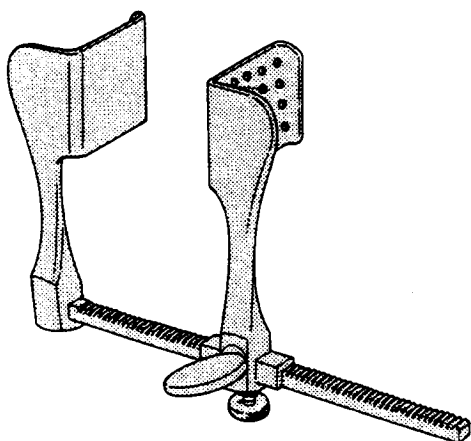
**Tuffier**

L2865-16 165mm, 50mm 45mm blade

Scissors

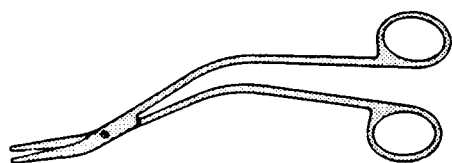

DeBakey
offset, half curve
L2875-15 155mm

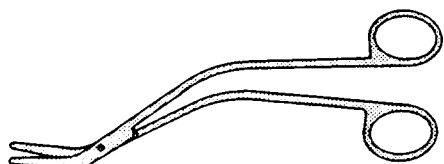

DeBakey
offset, full curve
L2875-16 155mm

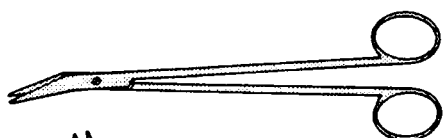

DeBakey Vascular

- angled blades 25°
- L2880-16 160mm
- L2880-23 230mm
- L2880-28 280mm
- angled blades 45°
- L2881-16 160mm
- L2881-23 230mm
- L2881-28 280mm
- angled blades 60°
- L2882-16 160mm
- L2882-23 230mm
- L2882-28 280mm

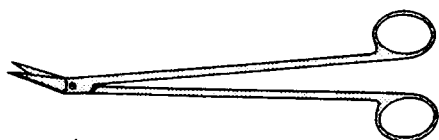
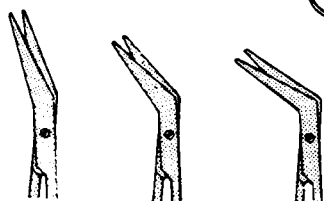

Potts-Smith

- angled blades 25°
- L2890-19 190mm
- angled blades 45°
- L2891-19 190mm
- angled blades 60°
- L2892-19 190mm
- angled blades 125°
- L2893-19 190mm

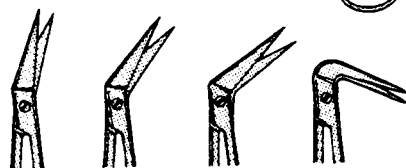

Scissors

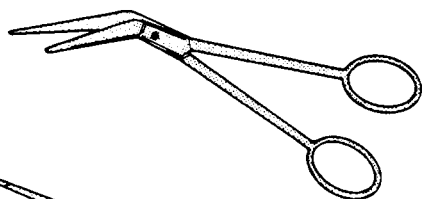

Vascular
Angled
L2900-14 145mm

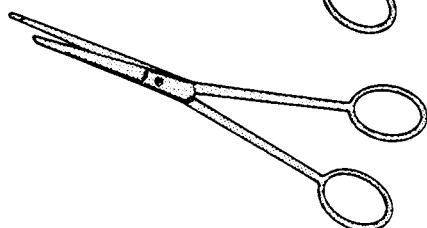

Vascular
Straight
L2901-14 145mm

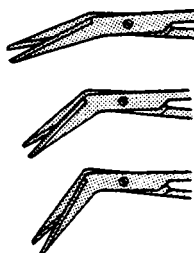
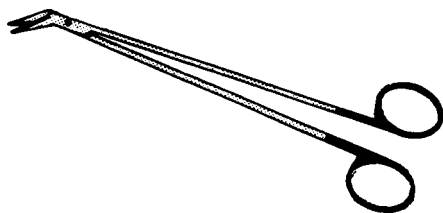

Scissors, Tungsten Carbide

**DeBakey Vascular**

angled blades 25°

L2910-18 180mm

angled blades 45°

L2911-18 180mm

angled blades 60°

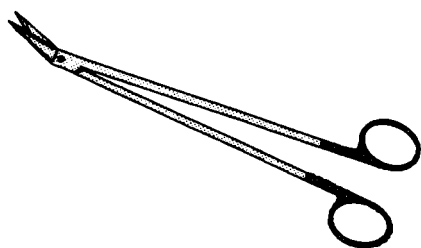
L2912-18 180mm**Potts-Smith**

angled blades 25°

L2920-19 190mm

angled blades 45°

L2921-19 190mm

angled blades 60°

L2922-19 190mm

Sternum Chisel

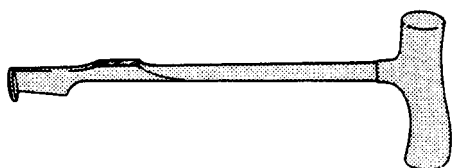
**Lebsche****L2930-24** 245mm

Tissue Forceps

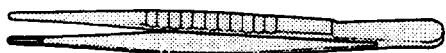
**DeBakey**

atraumatic 1/2 serrations, 1.5mm jaw

L2940-15 150mm**L2940-18** 180mm**L2940-19** 195mm**L2940-24** 240mm

atraumatic 1/2 serrations, 2mm jaw

L2941-15 150mm**L2941-18** 180mm**L2941-19** 195mm**L2941-24** 240mmNETIC
AID

Tourniquets

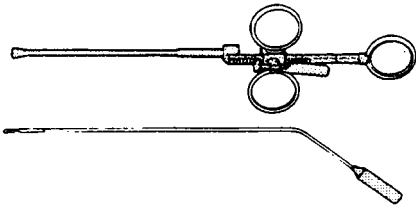
**Rumel-Belmont**

length 325mm

L2950-03 3.2mm**L2950-06** 6.4mm

Trocars

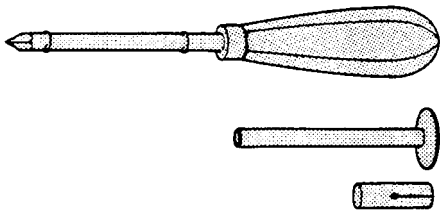
**Nelson Empyema**

complete with cannula, length 190mm

L2960-22 22fg**L2960-27** 27fg**L2960-33** 33fg

GYNAECOLOGY & OBSTETRICS

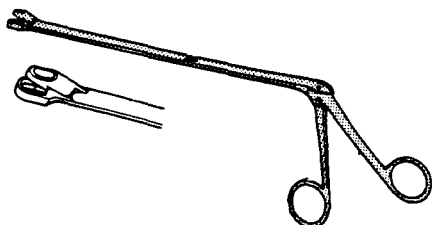

Biopsy Punch

**Eppendorf**

L3005-20 200mm effective length

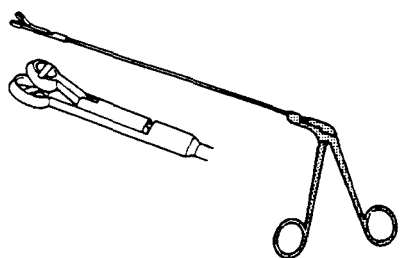
**Leech Wilkinson**

L3008-20 200mm effective length

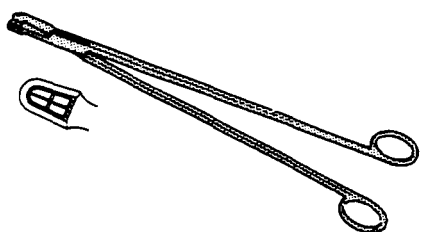
**Schubert**

straight

L3011-21 210mm effective length

L3011-29 290mm effective length

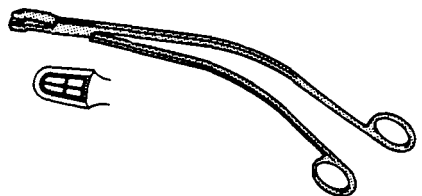
**Schubert**

angled shank

L3012-26 260mm effective length

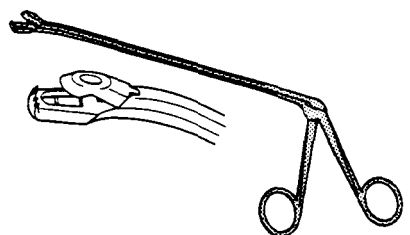
**Van Doren**

curved

L3015-26 265mm effective length

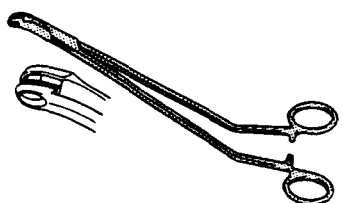
**Wittner Cervical**

curved to side

L3019-23 230mm effective length

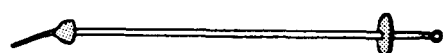
**Hayes-Provis Intra Uterine**

with rubber cone

L3022-27 275mm

Cannula

Cannula

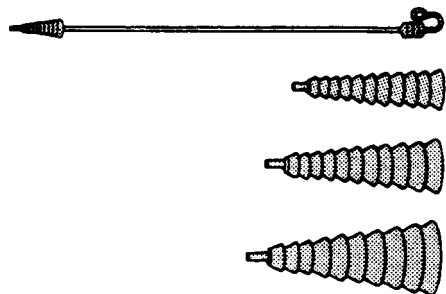
**Leech Wilkinson**

with Stilette, luer cone, 265mm
L3025-10 cone 10mm to 25mm
L3025-13 cone 13mm to 30mm
L3025-16 cone 16mm to 30mm

**Provis Intra Uterine**

L3028-27 275mm

**Spackman Intra Uterine**

with adjustable plate for use with vulsellum forceps
L3031-36 360mm

Catheters

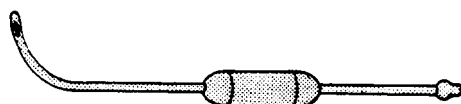
**Carton-Cowell**

lateral holes
L3033-23 230mm

**Drew Smythe Induction**

L3035-33 335mm

**Female**

round, with solid end, plated, 165mm
L3038-06 6Eg
L3038-07 7Eg
L3038-08 8Eg
L3038-09 9Eg
L3038-10 10Eg

**Rotunda**

oval, with solid end, plated, 200mm
L3041-08 8Eg
L3041-10 10Eg

Clamps

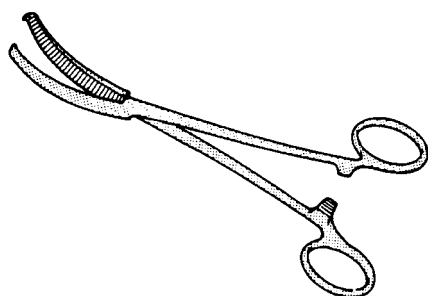
**Berkeley-Bonney**

curved on flat, 1/2 teeth, screw joint
L3050-20 200mm

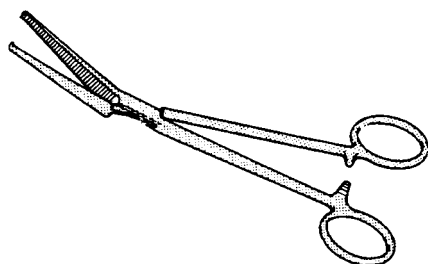
**Bonney**

angled on flat, 1/2 teeth
L3053-19 195mm

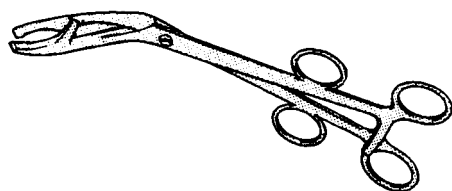
**Bonnet Myomectomy**

screw joint
L3056-26 265mm

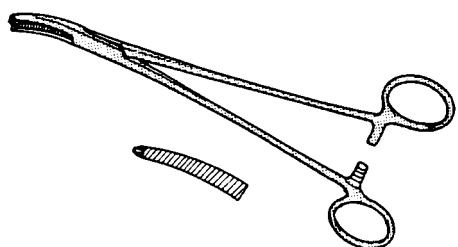
**Faure**

toothed
L3060-20 200mm

Clamps

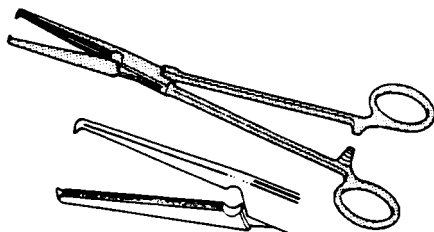
**Gwilliam**

straight, longitudinal serrations, 1/2 teeth
L3065-20 200mm

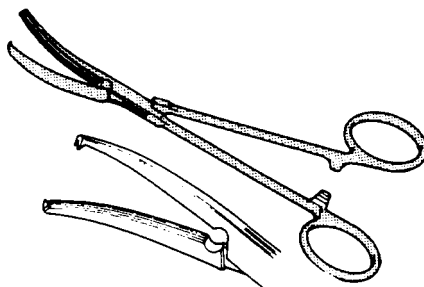
**Gwilliam**

curved on flat, longitudinal serrations, 1/2 teeth
L3066-20 200mm

Clamps

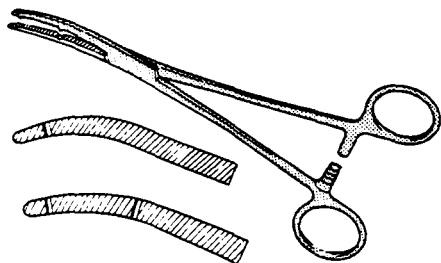
**Heaney**

curved, single tooth
L3070-19 195mm
L3070-21 210mm
L3070-23 230mm
 curved, double tooth
L3071-19 195mm
L3071-21 210mm
L3071-23 230mm

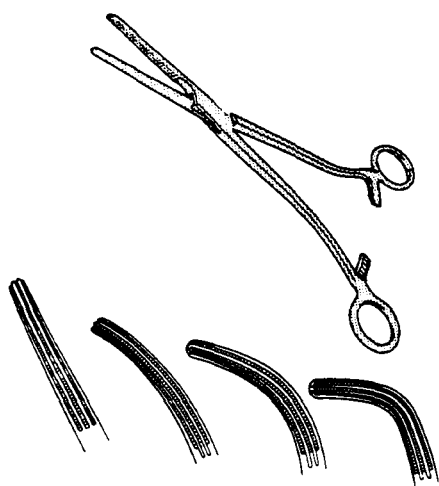
**Hysterectomy, Atraumatic**

straight, 2/3 teeth
L3075-22 220mm
L3075-24 240mm
 slight curve, 2/3 teeth
L3076-22 220mm
L3076-24 240mm
 full curve, 2/3 teeth
L3077-21 210mm
L3077-23 230mm
 angled, 2/3 teeth
L3078-21 210mm
L3078-23 230mm
L3078-30 set of 8 clamps

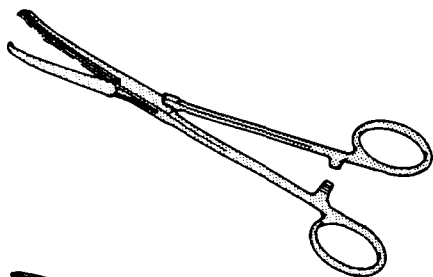
**Maingot**

curved on flat, 1/2 teeth
L3085-20 200mm
L3085-24 240mm

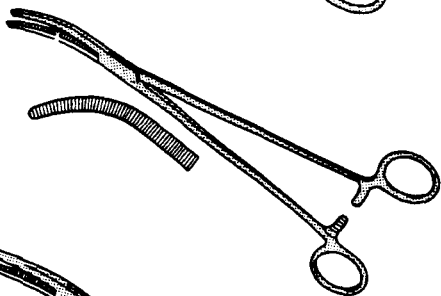
**Wertheim**

curved, serrated
L3090-25 250mm

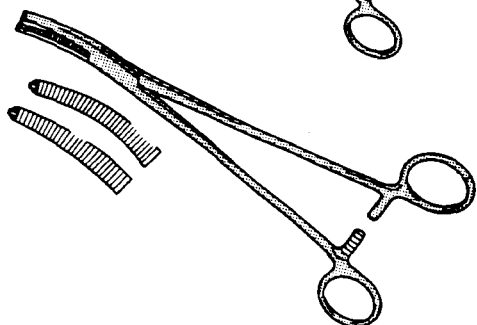
**Wertheim**

slightly curved, toothed
L3091-22 220mm
 curved, toothed
L3092-22 220mm

Curettes

**Gervis**

double ended sharp
L3100-26 265mm

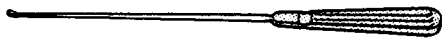
**Horrocks Uterine**

fine, semi-blunt
L3105-26 260mm

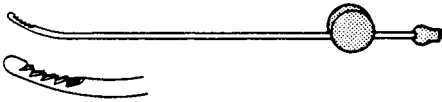
**Novak Suction**

L3110-25 250mm

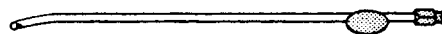
**Randall**

L3115-24 240mm

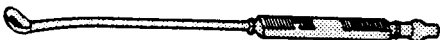
**Rheinstadter Uterine Flushing**

blunt edge, chromium plated shaft, 230mm

L3120-08 8mm

L3120-11 11mm

L3120-14 14mm

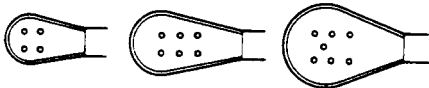

sharp edge, chromium plated shaft, 290mm

L3121-08 8mm

L3121-11 11mm

L3121-14 14mm

**Sharman Endometrial**

L3125-22 220mm

**Sims Uterine**

blunt, pliable shaft, 255mm

L3130-06 6mm

L3130-10 10mm

L3130-13 13mm

**Sims Uterine**

sharp, pliable shaft, 255mm

L3131-06 6mm

L3131-10 10mm

L3131-13 13mm

**Sims Uterine**

blunt/sharp combined

L3132-25 250mm

sharp/sharp combined

L3133-25 250mm

Destructive Instruments

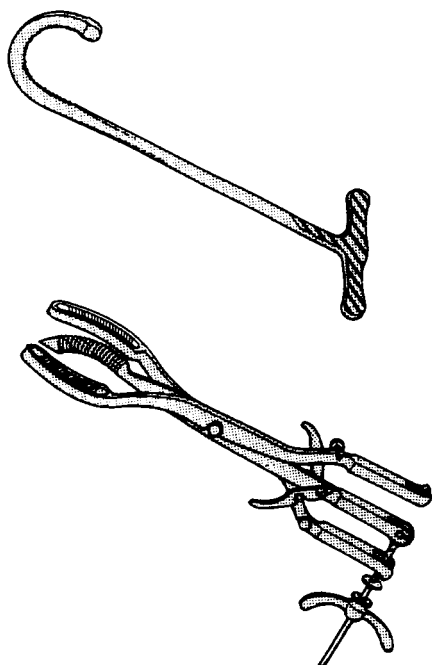
**Galabin Decapitator**

saw edge
L3140-30 300mm

Winter Cranioclast

take off joint
L3145-30 300mm

Dilators, Cervix

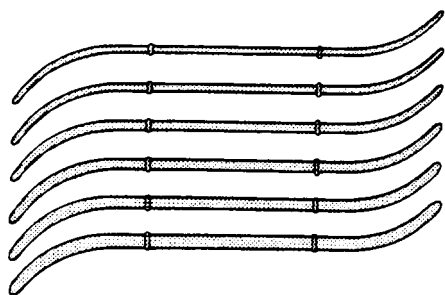
**Hank**

double ended
L3150-09 9/10mm
L3150-11 11/12mm
L3150-13 13/14mm
L3150-15 15/16mm
L3150-17 17/18mm
L3150-19 19/20mm
L3150-20 set of 6 sizes

**Hawkin Ambler**

conical 170mm
L3155-06 6mm, size 3
L3155-07 7mm, size 4
L3155-08 8mm, size 5
L3155-09 9mm, size 6
L3155-10 10mm, size 7
L3155-11 11mm, size 8
L3155-12 12mm size 9
L3155-13 13mm size 10
L3155-14 14mm size 11
L3155-15 15mm, size 12
L3155-16 16mm, size 13
L3155-17 17mm, size 14
L3155-20 set of 12 sizes

Dilators, Cervix

Hegar

Single ended, 185mm

L3160-02	2mm
L3160-03	3mm
L3160-04	4mm
L3160-05	5mm
L3160-06	6mm
L3160-07	7mm
L3160-08	8mm
L3160-09	9mm
L3160-10	10mm
L3160-11	11mm
L3160-12	12mm
L3160-13	13mm
L3160-14	14mm
L3160-15	15mm
L3160-16	16mm
L3160-17	17mm
L3160-20	set of 16 sizes

**Hegar**

double ended, 220mm

L3161-03	3/4mm
L3161-05	5/6mm
L3161-07	7/8mm
L3161-09	9/10mm
L3161-11	11/12mm
L3161-13	13/14mm
L3161-15	15/16mm
L3161-17	17/18mm
L3161-20	set of 8 sizes

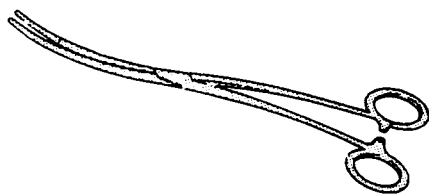
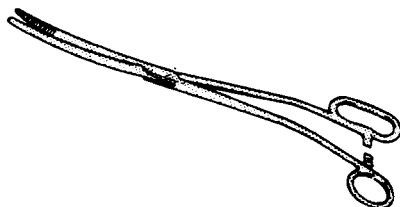

Dressing Forceps

Bozemann Uterine**L3170-26** grooved jaw, 265mm**Bozemann Uterine****L3171-26** serrated jaw, 265mm

Guides

Pudendal Nerve Block

luer, complete with needle

L3175-14 140mm

Myoma Screw

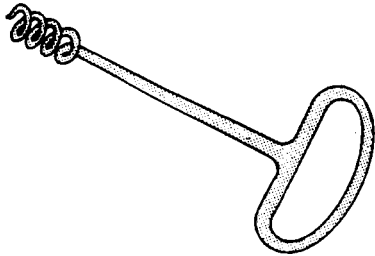

Doyen
for abdominal use
L3180-15 150mm

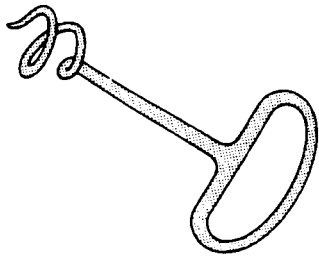

Doyen
for vaginal use
L3181-17 175mm

Obstetric Forceps

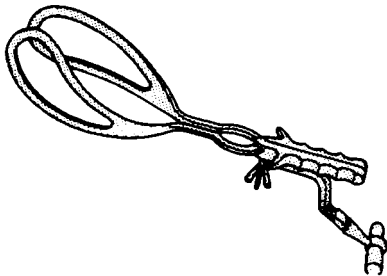

Barnes
with Simpson handle and Neville axis traction rod
L3190-41 410mm

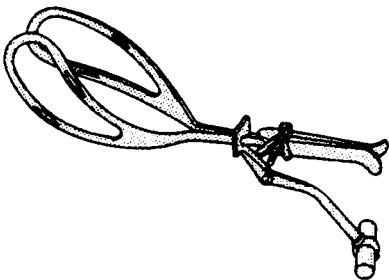

Haig Ferguson
complete with traction rod
L3195-33 330mm

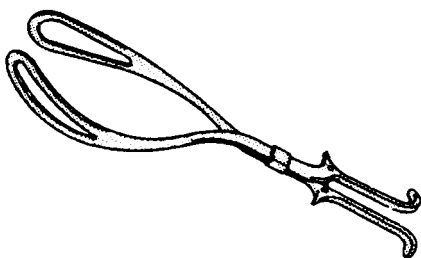

Kielland
L3200-41 410mm

Obstetric Forceps

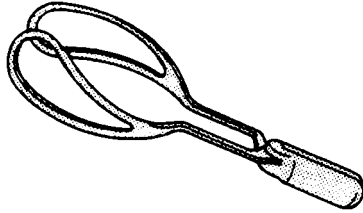
**Simpson**

short model
L3205-28 280mm

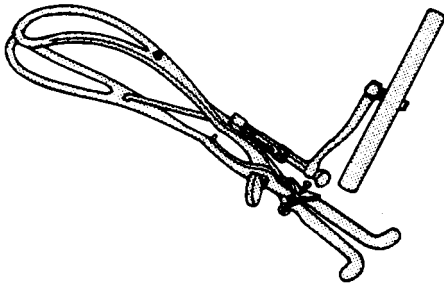
**Tarnier**

complete with traction handle
L3210-40 400mm

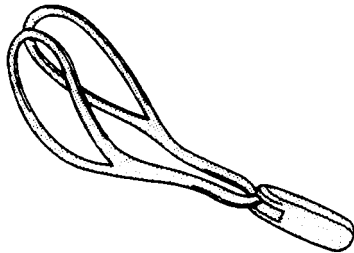
**Wrigley**

short model
L3215-25 250mm

Ovum Forceps

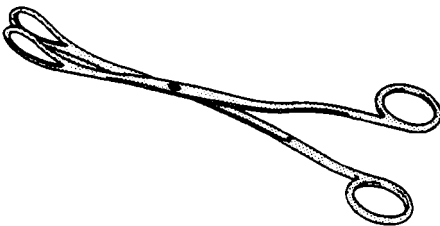
**Greenhalgh**

screw joint
L3220-24 240mm

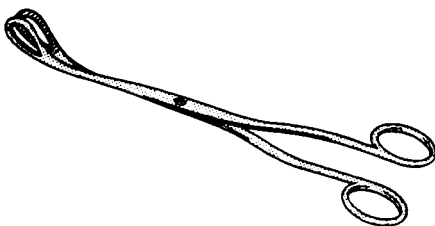
**McClintock**

curved, screw joint
L3225-24 240mm

Pelvimeters

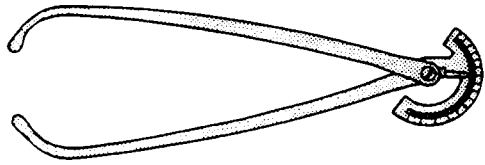

Collin
L3235-35 350mm

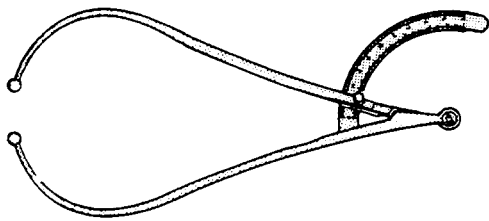

Martin
scale in cms/inches
L3240-34 340mm

Perforators



Nagele
L3250-25 250mm

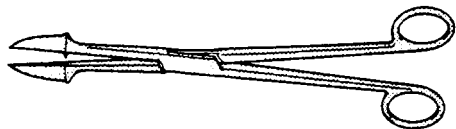

Smellie
L3255-25 250mm

Peritoneum Forceps

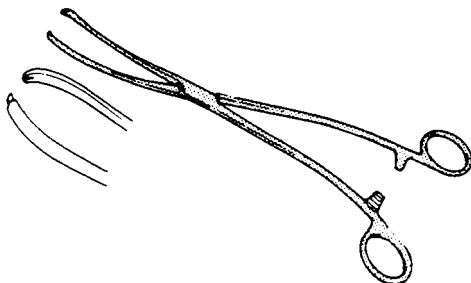

Goodwin Amnietomy
double curve
L3265-25 250mm

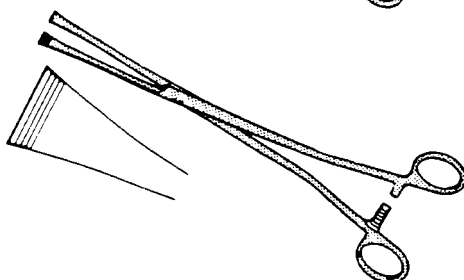

Green Armytage
straight
L3270-20 200mm

Peritoneum Forceps

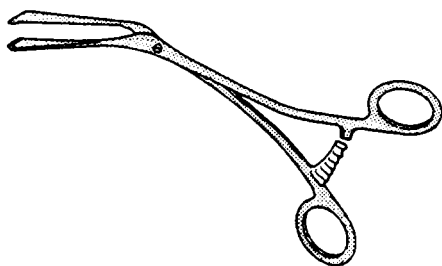
**Green Armytage**

angled, screw joint
L3271-19 195mm

Probes

**Anel Silver**

with eye
L3275-11 110mm

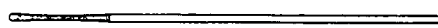
**Playfair**

L3280-30 300mm

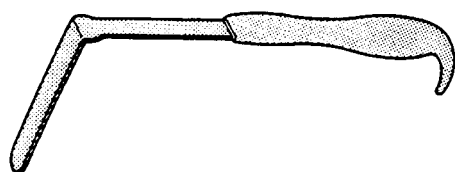

Retractors

**Doyen**

L3290-10 100mm 30mm blade

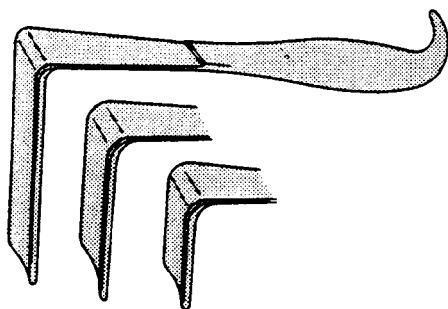
**Doyen (Pozzi)**

L3295-0 small, 48mm 60mm
L3295-09 medium, 48mm 90mm
L3295-12 large, 48mm 124mm

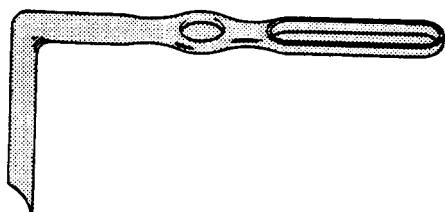
**Landon Vaginal**

L3305-09 90mm 25mm blade

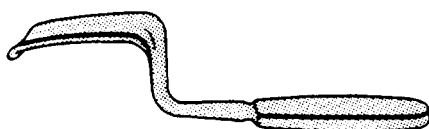
**Wertheim**

L3310-09 95mm 38mm blade

Retractors, Self-Retaining

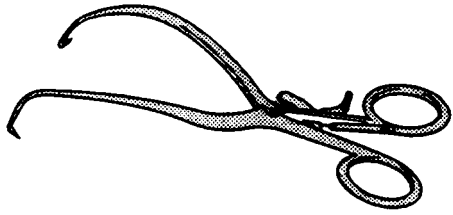

Gelpi Vulva
L3315-17 170mm

Scissors

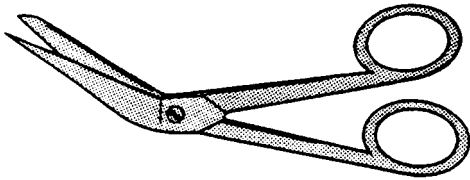

Barnes
episiotomy
L3220-12 125mm

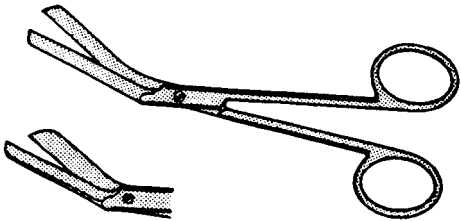

Braun-Stadler
episiotomy
L3325-14 140mm
L3325-20 200mm

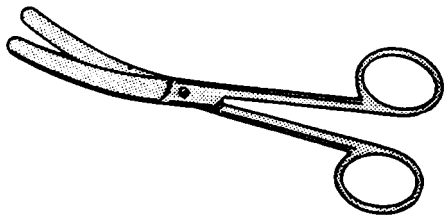

Busch
episiotomy
L3330-12 125mm
L3330-16 160mm

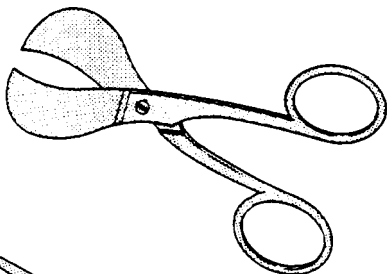

Umbilical
American Pattern
L3335-10 100mm

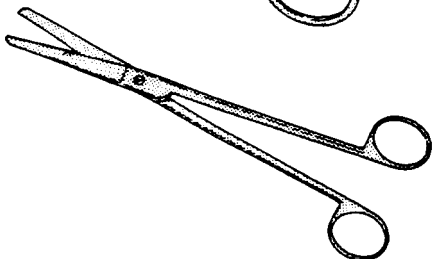

Uterine
straight
L3340-23 230mm

Scissors

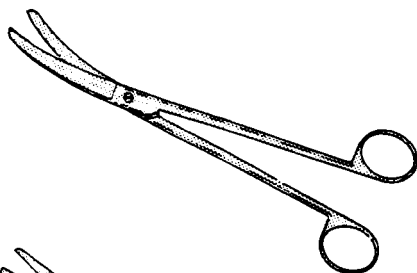

Uterine
curved
L3341-23 230mm

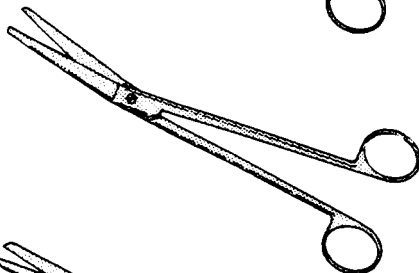

Uterine
angled
L3342-23 230mm

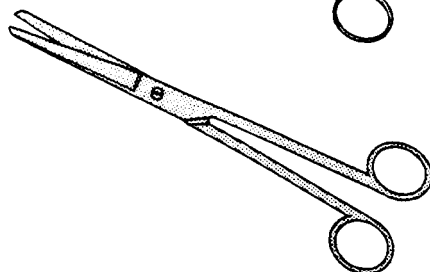

Vant
episiotomy
L3345-24 240mm

Sounds



Galabin
malleable, shaft graduated in cms
L3355-29 290mm

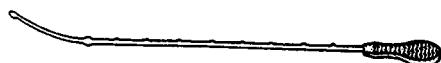

Horrocks Uterine
malleable, shaft graduated in 2cm
L3360-30 300mm



Simpson Uterine
malleable
L3365-32 320mm

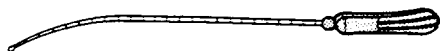

Sims Uterine
malleable
L3370-32 320mm

Stethoscopes

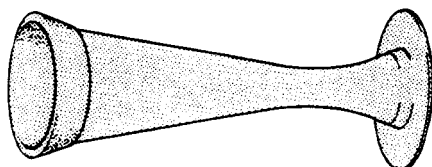

Pinard Foetal
aluminium
L3380-14 140mm
plastic
L3381-14 140mm

Suction Tubes

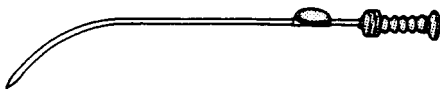

Gillies
L3390-17 175mm

Uterine Forceps

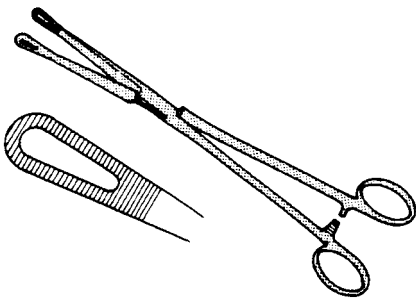

Bonney Polypus
oval
L3400-24 240mm
ring
L3401-24 240mm

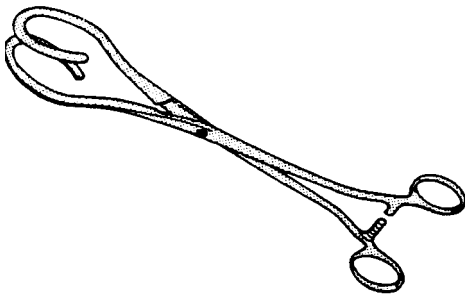

Dartigues
open jaws, screw joint
L3410-27 270mm

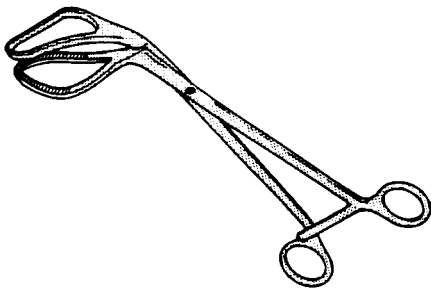

Somer
angled jaws, screw joint
L3415-23 230mm

Vaginal Specula

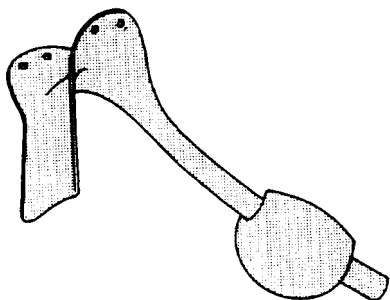

Auvard
L3425-01 with detachable weight
L3426-01 with fixed weight

Vaginal Specula

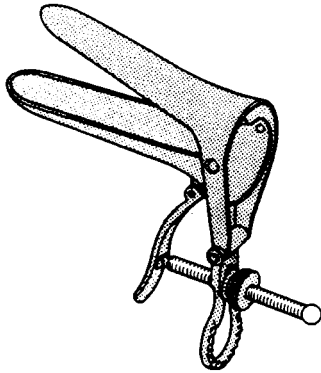
**Cusco**

L3430-01 virgin
L3430-02 small
L3430-03 medium
L3430-04 large

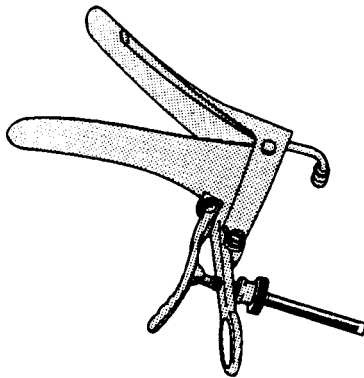
**Cusco**

with suction tube for use with laser
L3432-01 virgin
L3432-02 small
L3432-03 medium
L3432-04 large

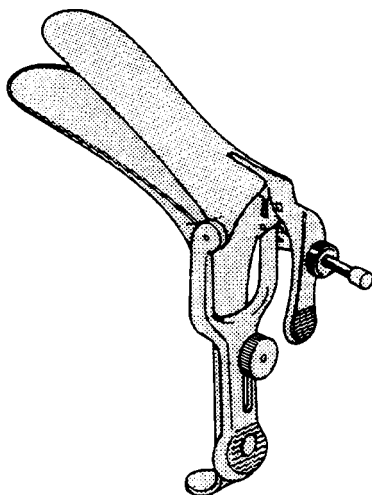
**Graves**

L3435-01 small
L3435-02 medium
L3435-03 large

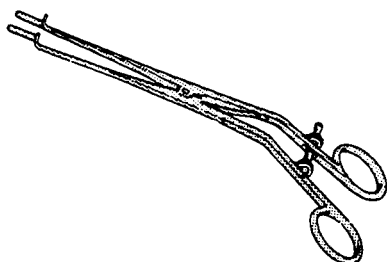
**Kogan Endocervical**

L3440-24 240mm

Vaginal Specula

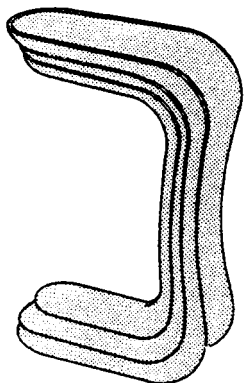
**Sims**

double ended

L3445-01 small**L3445-02** medium**L3445-03** large**L3445-04** set of 3

Vulsellum Forceps

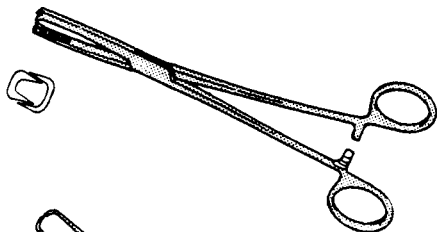
**Jacobs**

2/2 teeth

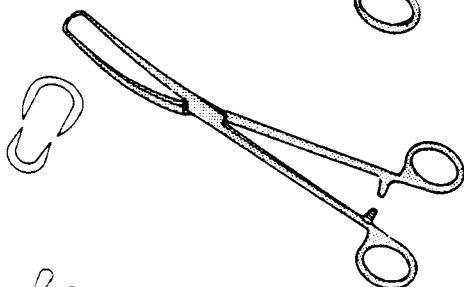
L3450-21 210mm**Lewer**

2/2 teeth

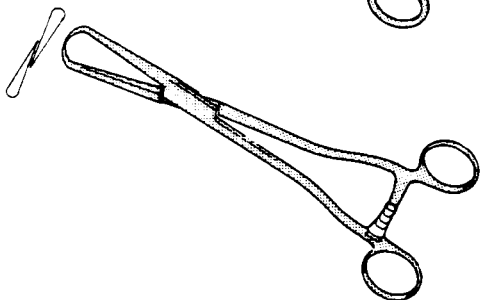
L3455-18 180mm**L3455-23** 230mm**Luer**

1/1 teeth

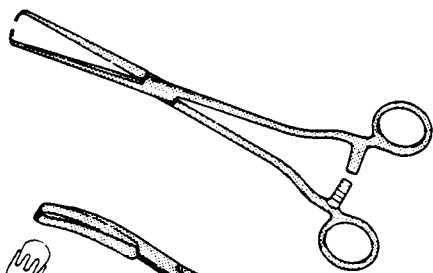
L3460-23 230mm**Schroeder Uterine**

1/1 teeth

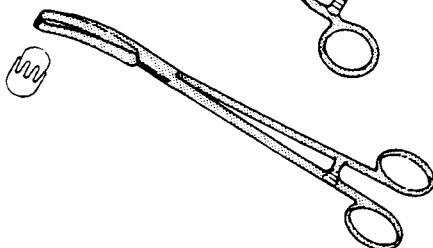
L3465-22 225mm**Teales Uterine**

curved, 3/4 teeth

L3470-18 180mm**L3470-23** 230mm

straight

L3471-23 230mm

UROLOGY



Bougies

**Clutton Urethral**

tapered, length 265mm

L3505-06	6/10 fg
L3505-08	8/12 fg
L3505-10	10/14 fg
L3505-12	12/16 fg
L3505-14	14/18 fg
L3505-16	16/20 fg
L3505-18	18/22 fg
L3505-20	20/24 fg
L3505-22	22/26 fg
L3505-24	24/28 fg
L3505-26	26/30 fg
L3505-28	28/32 fg
L3505-30	set of 12

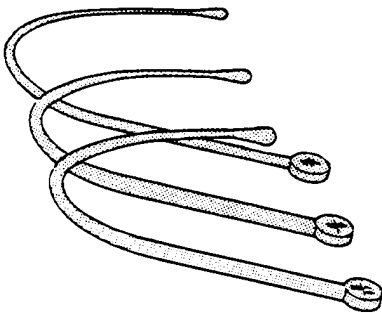
**Hey Groves**

retrograde, length 170mm

L3515-04	4/7 Eg
L3515-06	6/9 Eg
L3515-08	8/11 Eg
L3515-10	set of 3

**Lister Urethral**

olive ends, length 280mm

L3525-06	6fg
L3525-08	8fg
L3525-09	9fg
L3525-10	10fg
L3525-12	12fg
L3525-14	14fg
L3525-15	15fg
L3525-16	16fg
L3525-18	18fg
L3525-20	20fg
L3525-21	21fg
L3525-22	22fg
L3525-24	24fg
L3525-26	26fg
L3525-27	27fg
L3525-28	28fg
L3525-30	30fg
L3525-35	set of 17

**Wyndham Powell**

length 170mm

L3535-15	15fg
L3535-16	16fg
L3535-17	17fg
L3535-18	18fg
L3535-19	19fg
L3535-20	20fg
L3535-21	21fg
L3535-22	22fg
L3535-23	23fg
L3535-24	24fg
L3535-25	25fg
L3535-26	26fg
L3535-27	27fg
L3535-28	28fg
L3535-29	29fg
L3535-30	30fg
L3535-31	31fg
L3535-32	32fg
L3535-35	set of 18



Catheter Introducers



Denis Browne
curved
L3545-30 300mm

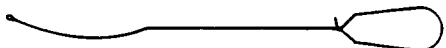

Foley Balloon
curved
L3550-45 455mm



Guyon
curved, 430mm
L3560-02 small tip 2mm diameter
L3560-04 large tip 4mm diameter



Guyon
deep curve, 510mm
L3561-03 tip 2.5mm

Clamps

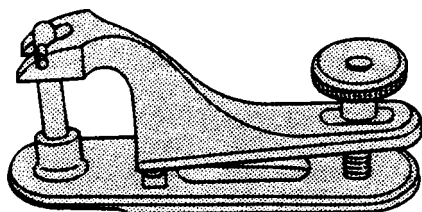

Circumcision
L3570-05 8mm
L3570-11 11mm
L3570-13 13mm
L3570-16 16mm
L3570-21 21 mm
L3570-26 26mm
L3570-32 32mm

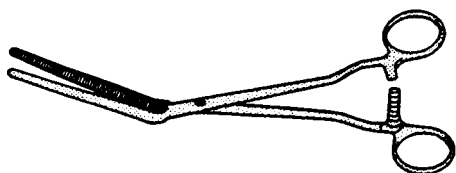

Thomson-Walker Pedicle
angled, screw joint
L3580-20 200mm

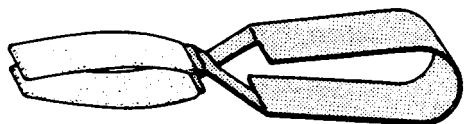

Thomson-Walker Penile
cross action
L3581-11 115mm

Clamps, Atraumatic

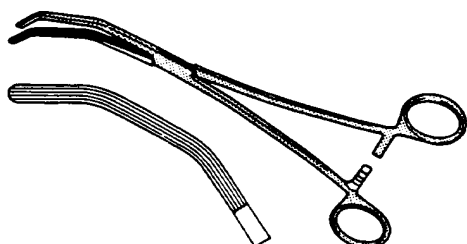

Herrick Kidney Pedicle
1/2 serrations, double angle
L3590-26 265mm

Dilators

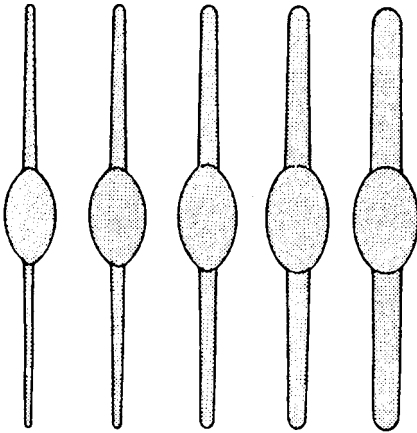
**Turner Warwick**

double ended, 160mm

L3600-04 4/9fg and 7/12fg**L3600-11** 10/15fg and 15/18fg**L3600-16** 16/21fg and 19/24fg**L3600-22** 22/27fg and 25/30fg**L3600-28** 28/33fg and 31/36fg**L3600-30** set of 5

Dissecting Forceps

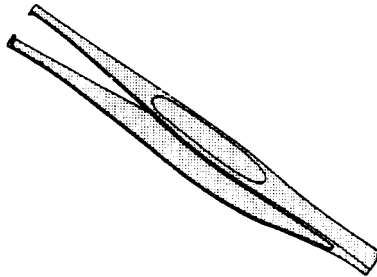
**Millins**

3/4 teeth

L3610-22 225mm

Evacuator

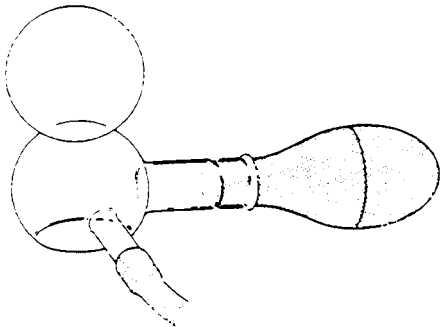
**Ellick****L3630-01** complete**L3630-02** spare bulb**L3630-03** spare glass**L3630-04** spare tube

Needleholders

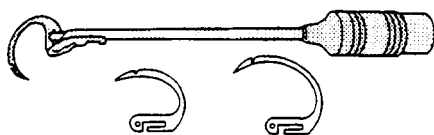
**Millin Boomerang**

Length 225mm

L3640-01 complete with 3 needles**L3641-02** needle, small**L3641-03** needle, medium**L3641-04** needle, large

Nozzle

**Alban Andrew**

to fit ureteric catheters and Luer fitting syringes

L3650-35 35mm

Probes

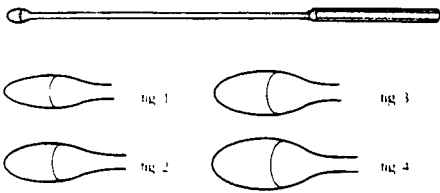
**Desjardin Gallstone**

malleable, 300mm

L3660-01 fig 1**L3660-02** fig 2**L3660-03** fig 3**L3660-04** fig 4

Prostatectomy Forceps

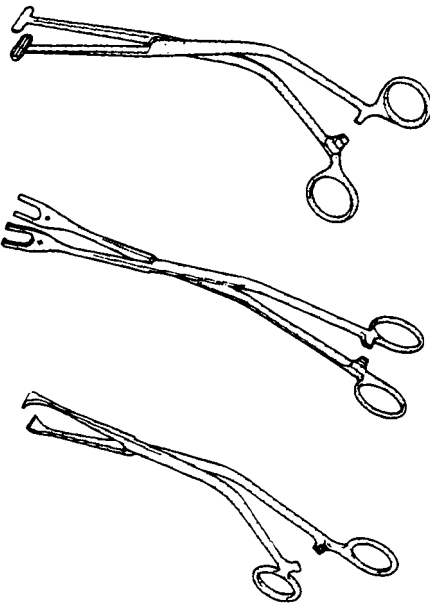
**Millin**

capsule, screw joint

L3670-23 230mm**Millin**

ligature carrying, screw joint

L3671-23 230mm**Millin**

vulsellum, 8/9 teeth, screw joint

L3672-23 230mm

Retractors

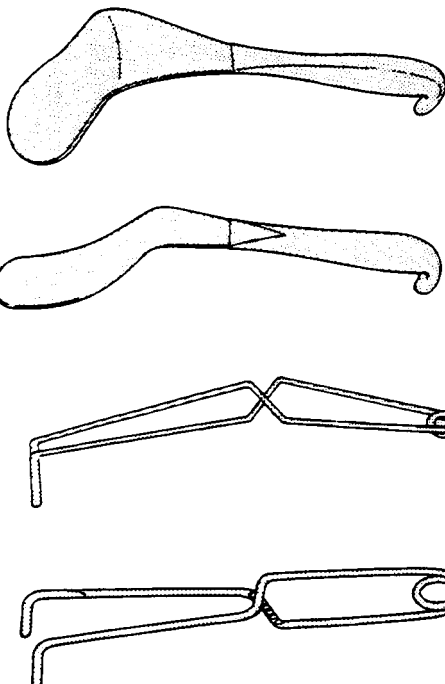
**Kocher****L3680-26** 260mm, 67mm blade**Legueu****L3690-27** 270mm, 35mm blades**Millin Bladder**

neck spreader, cross action

L3700-24 240mm**Millin Bladder**

neck spreader, cross action, with rack

L3700-25 240mm

Retractors, Self-Retaining

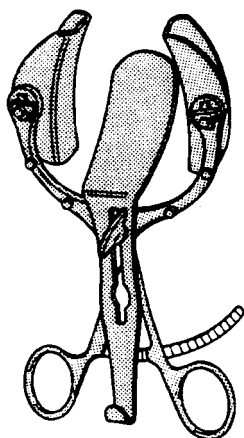
**Legueu**

L3710-28 28mm 60mm blades with 80mm 30mm centre blade

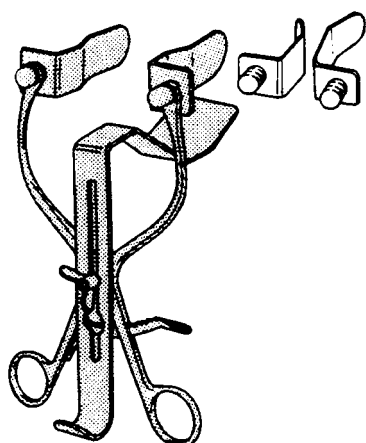
**Millin Retropubic**

complete with 2 sets of blades

L3715-55 2 each 55mm 25mm and 80mm 25mm blades with 115mm 45mm centre blades

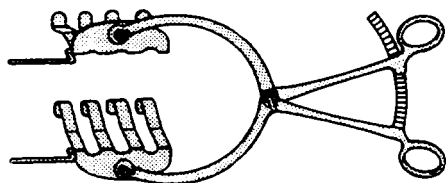
**St Marks Hospital**

with swivel blades, fitted with towel pegs

L3725-22 220mm

Stone Forceps

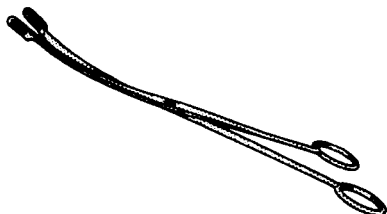
**Randall Renal Calculus**

screw joint, fenestrated jaw

L3735-23 shape A, 230mm

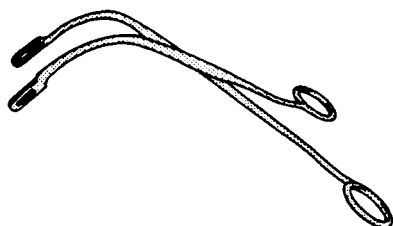
**Randall Renal Calculus**

screw joint, fenestrated jaw

L3736-21 shape B, 210mm

Stone Forceps

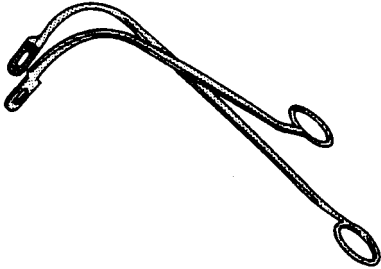
**Randall Renal Calculus**

lift-off joint, fenestrated jaw
L3737-19 shape C 195mm

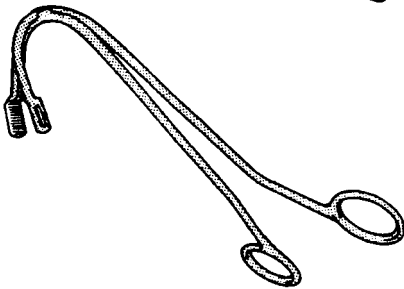
**Randall Renal Calculus**

lift-off joint, fenestrated jaw
L3738-18 shape D, 180mm

Syringe

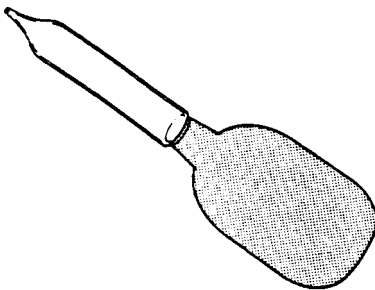
**Canny Ryall**

with PVC bulb
L3750-16 160mm

Trocars

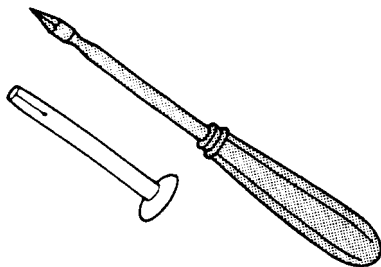
**Suprapubic**

straight complete with cannula, length 112mm
L3760-25 25fg
L3760-30 30fg

PROCTOLOGY

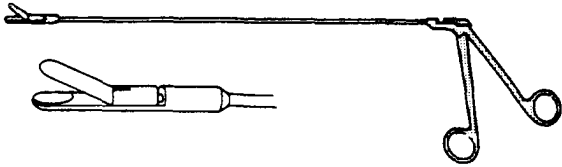

Biopsy Forceps

**Lloyd Davis Sigmoidoscope**

L3805-35 350mm effective length

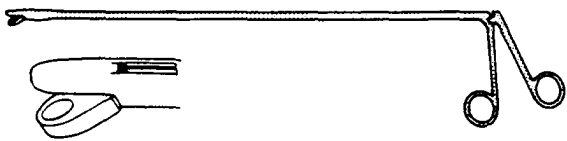
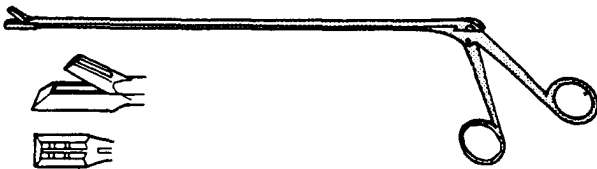
**Officer**8mm cup jaws, to use through sigmoidoscope
L3815-43 430mm effective length**Yeoman**basket-jawed to use through sigmoidoscope
L3820-25 250mm effective length
L3820-35 355mm effective length
L3820-43 430mm effective length

Clamps

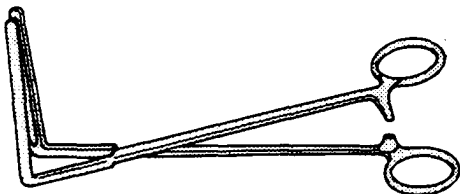
**Finch Excision**with hallowed jaws
L3830-21 215mm, 75mm blade

Clamps, Atraumatic

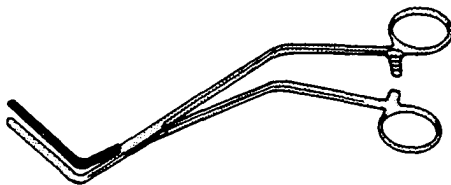
**Hayes**jaws angled 70°
L3840-26 260mm, 80mm jaws
L3840-28 280mm, 100mm jaws

Dilators

**St Marks Rectal**small
L3845-14 14mm 19mm
large
L3845-16 16mm 25mm

Directors

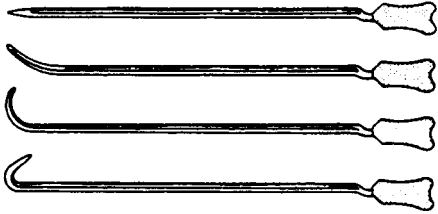
**Lockhart Mummyry Fistula**

length 165mm

L3850-01 No.1 straight**L3850-02** No.2 45° curve**L3850-03** No.3 90° curve**L3850-04** No.4 Retrograde

Dissecting Forceps

**Officer**

serrated

L3855-15 150mm**L3855-20** 200mm**L3855-25** 250mm**Officer**

2/3 teeth

L3856-15 150mm**L3856-20** 200mm

4/5 teeth

L3857-15 150mm**L3857-20** 200mm**L3857-25** 250mm

Haemorrhoid Ligator Set

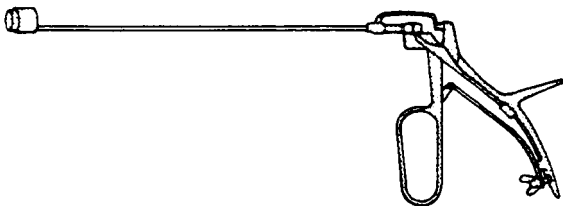
**Barron**

comprising

L3860-21**L3860-22****L3860-23**ligator, conical loader, 300 'O' rings and handle
215mm, complete

spare conical loader

spare rings, pack of 300

Proctoscopes

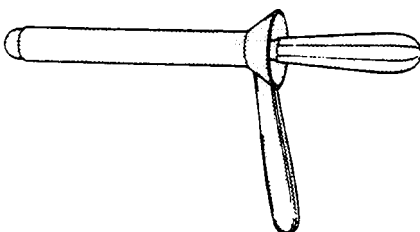
**Kelly**

with obturator

L3865-22 22mm 50mm**L3865-23** 22mm 100mm**L3865-24** 22mm 140mm**L3865-25** 22mm 200mm

Rectal Snare

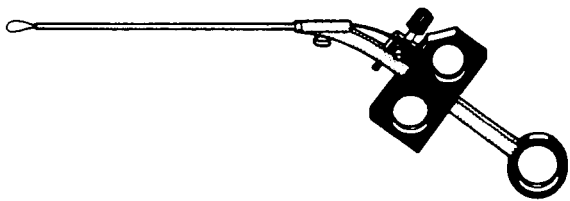
**Frankfeldt**

insulated, handle with cords and 3 shafts, one each 200mm, 305mm and 400mm
L3868-20 complete

Rectal Specula

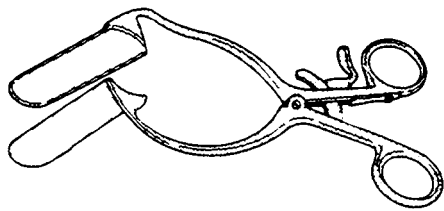
**Barr**

L3870-17 170mm, 70mm 22mm blade

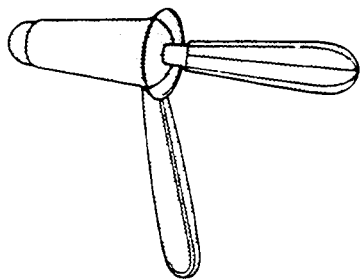
**Kelly**

with obturator
L3873-21 21 mm 50mm
L3873-27 27mm 50mm

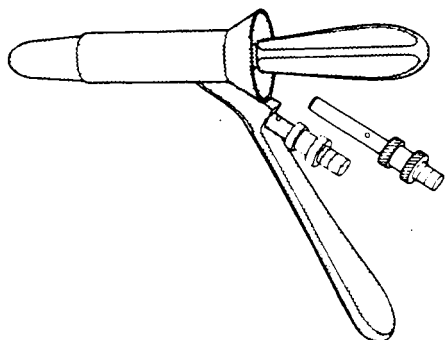
**Naunton Morgan**

for use with fibre light carrier
L3875-17 17mm diameter
L3875-20 20mm diameter
L3875-24 24mm diameter

Rectal Specula

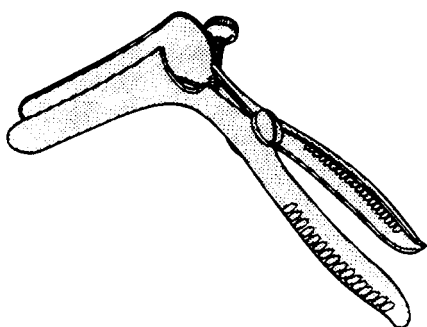
**Sims**

solid blades
L3880-15 150mm

Rectal Specula

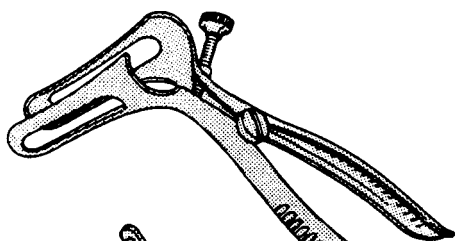
**Sims**

slotted blades
L3881-15 150mm

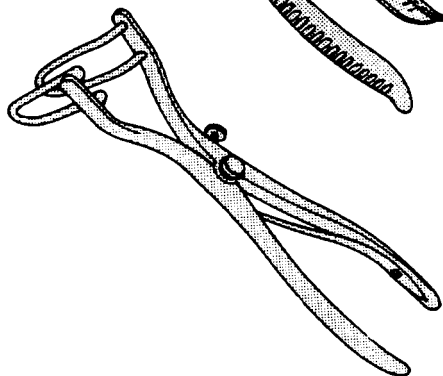
**Sims**

fenestrated blades
L3882-06 220mm, 60mm blade
L3882-08 220mm, 80mm blade
L3882-12 220mm, 125mm blade
L3882-15 220mm, 150mm blade

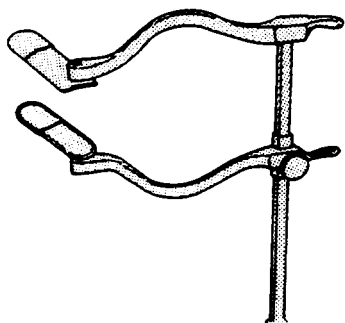
**Smith-Buir**

L3890-15 150mm

Retractors

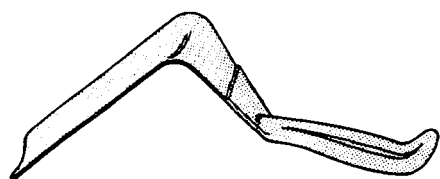
**Lloyd-Davis**

short, without tapered end
L3895-12 125mm 55mm
long, with tapered end
L3895-17 170mm 65mm 50mm

Retractors, Self-Retaining

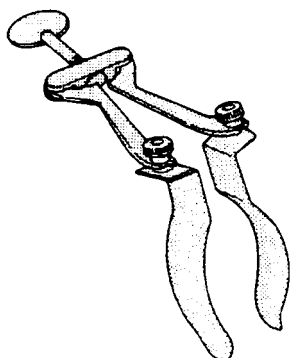
**Park Anal**

L3900-13 130mm, 95mm blades

Retractors, Self-Retaining

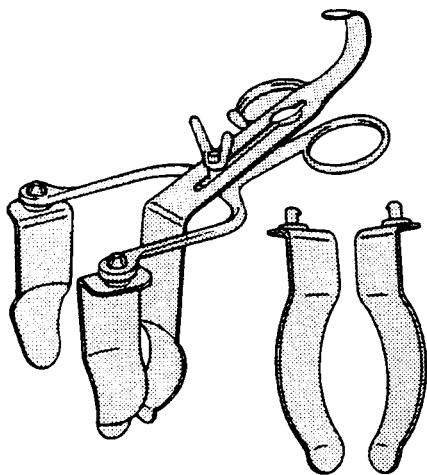
**Park Combined**

with 2 sets of interchangeable blades and one adjustable centre blade, 140mm
L3905-14 complete

Scissors

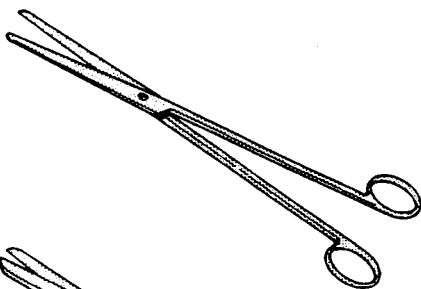
**Abel Abdominal-Perineal**

straight
L3915-32 320mm

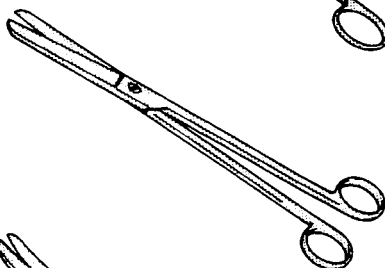
**Goligher**

straight
L3920-30 300mm
L3920-33 330mm

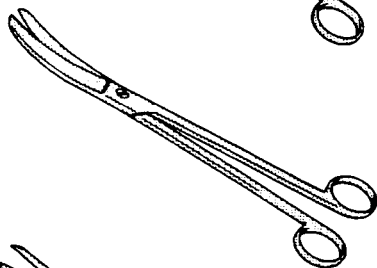
**Goligher**

curved
L3921-30 300mm
L3921-33 330mm

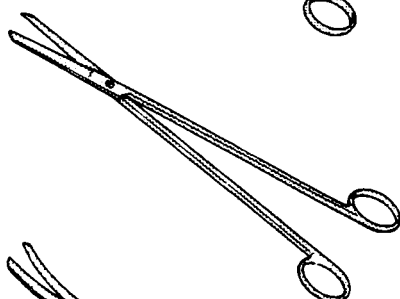
**Lloyd-Davis Rectal**

straight, flattened blades, blunt points
L3925-26 265mm

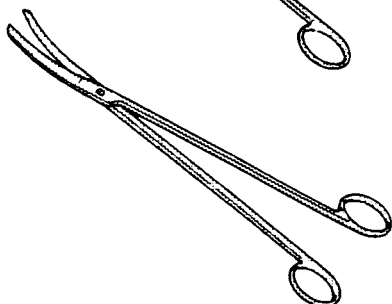
**Lloyd-Davis Rectal**

curved on flat, flattened blades, blunt points
L3926-26 265mm

Sigmoidoscopes

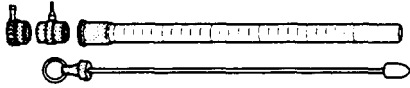
**Lloyd-Davis**

combination set, comprising 1 graduated tube 250mm 15mm with obturator, 1 graduated tube 300mm 20mm with obturator, inflation window with fibre light carrier
L3935-25 complete in wooden case

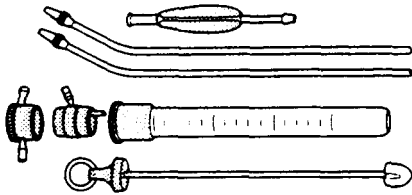
**Lloyd-Davis**

operating set, comprising 1 graduated tube 200mm 25mm, obturator, inflation window, 2 suction tubes, universal handle, with fibre light carrier
L3936-20 complete in wooden case

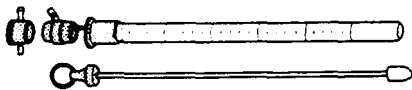
**Lloyd-Davis**

small set, comprising stainless steel tube graduated 250mm 15mm, inflation window and fibre light carrier
L3937-25 complete

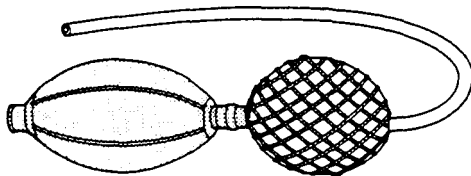
**Inflation Bellows**

L3950-01 rubber, double

Suction tubes

**Richards**

chromium plated
L3955-38 385mm

Syringe

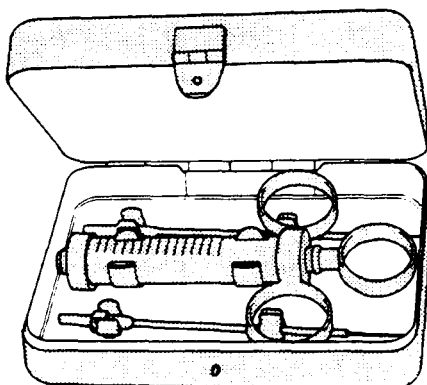
**Gabriel**

L3960-03 3ml complete with 2 needles
L3960-10 10ml complete with 2 needles

NEUROSURGERY

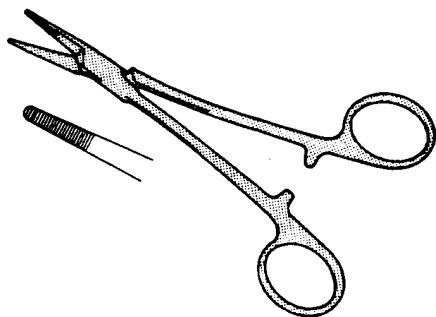

Artery Forceps

**Cairns**

straight, half serrated jaws
L5105-14 145mm

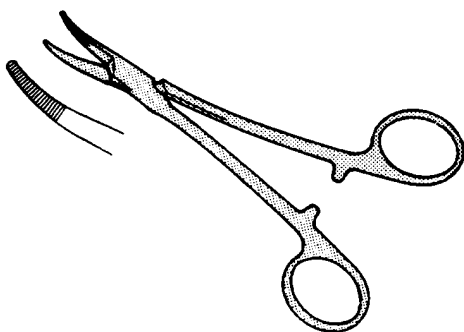
**Cairns**

curved, half serrated jaws
L5106-14 145mm

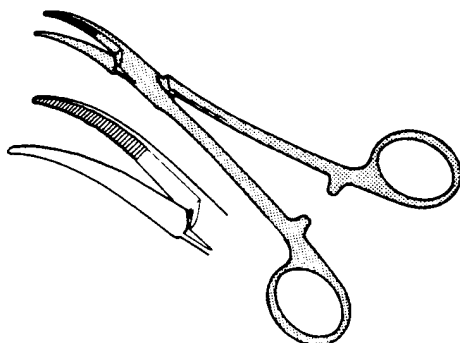
**Cairns**

curved to side, half serrated jaws
L5107-14 145mm

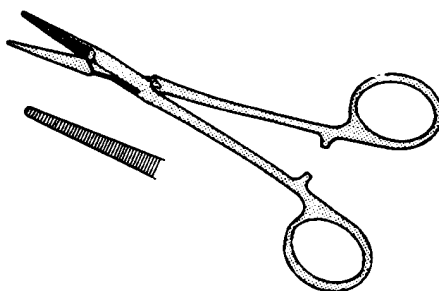
**Crile**

straight, serrated jaws
L5115-14 140mm
L5115-16 160mm
L5115-18 180mm

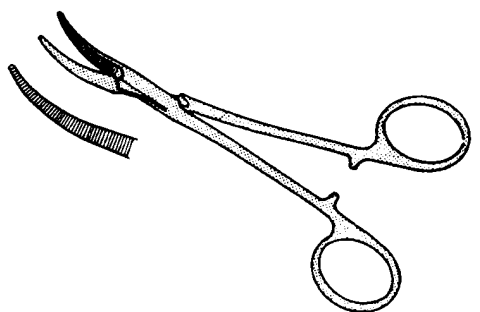
**Crile**

curved, serrated jaws
L5116-14 140mm
L5116-16 160mm
L5116-18 180mm

Artery Forceps

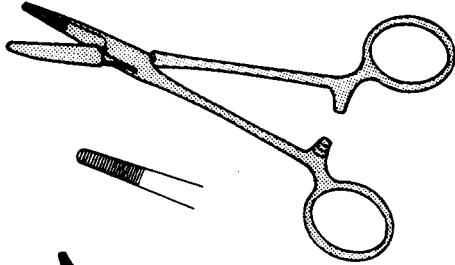
**Cushing**

straight, fine half serrated jaws
L5125-14 145mm

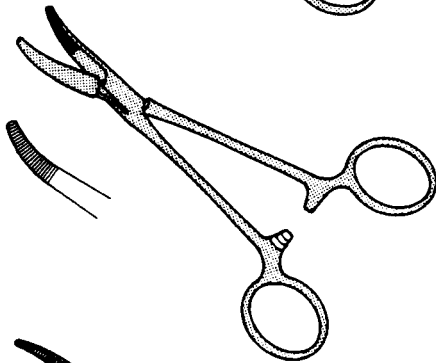
**Cushing**

curved, fine half serrated jaws
L5126-14 145mm

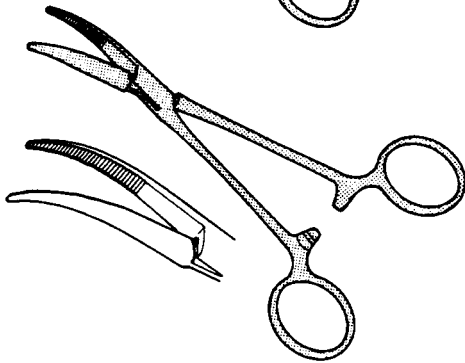
**Cushing**

curved to side, fine half serrated jaws
L5127-14 145mm

Brace

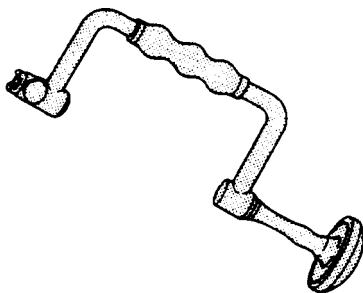
**Hudson**

L5135-01 universal fitting

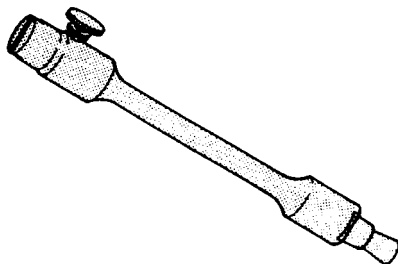
**Hudson Extension Piece**

L5140-01 for use with Hudson Brace

Burs

Hudson Conical

L5150-09 9mm
 L5150-11 11mm
 L5150-13 13mm
 L5150-14 14mm
 L5150-16 16mm
 L5150-22 22mm

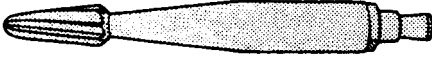
**Hudson Spherical**

L5155-06 5mm
 L5155-08 8mm
 L5155-11 11mm
 L5155-12 12mm
 L5155-13 13mm
 L5155-16 16mm
 L5155-19 19mm
 L5155-22 22mm

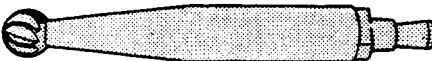
**Hudson Perforator**

L5160-10 10mm
 L5160-12 12mm
 L5160-14 14mm
 L5160-15 15mm

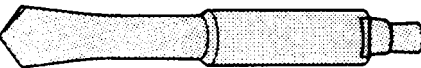
**Spiral Undercut**

L5165-10 100mm 12mm

Cannula

Cone Ventricular

graduated in cms, luer fitting
 L5185-12 1.22mm diameter
 L5185-16 1.63mm diameter
 L5185-20 2.03mm diameter

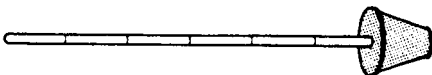
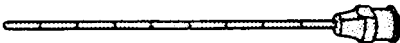
**Jefferson Ventricular**

graduated in cms, luer fitting
 L5195-06 60mm
 L5195-08 80mm
 L5195-10 100mm

Clip Forceps

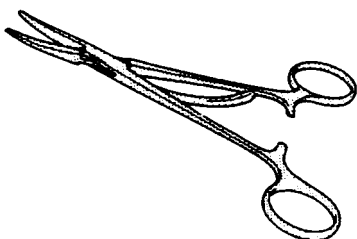
**McKenzie**

curved, applying
 L5205-14 140mm
 L5205-17 175mm

Clip Forceps

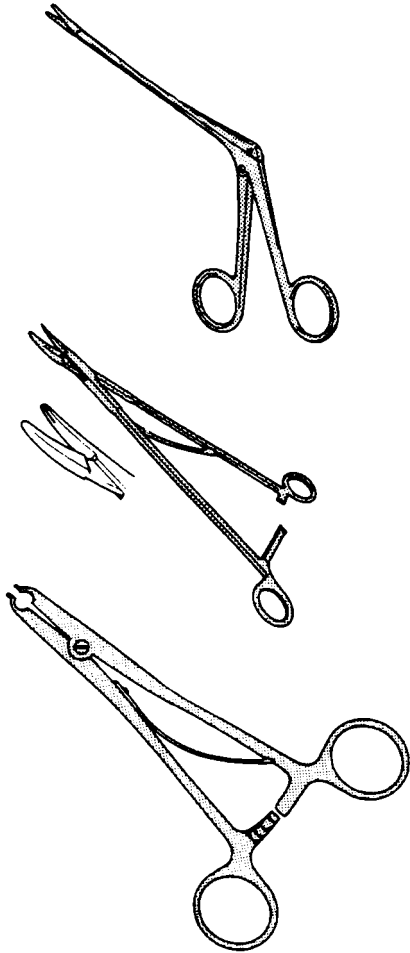
**Olivecrona**

crocodile action, applying
L5207-14 140mm effective length

Olivecrona

curved, applying
L5208-21 210mm

Raney

applying
L5210-16 160mm

Curettes

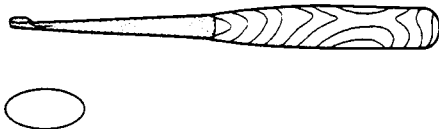
**American Spinal**

straight, tufnol handle, 250mm

L5230-20 2.0mm 4mm

L5230-25 2.5mm 4.5mm

L5230-27 2.75mm 5mm

L5230-30 3.0mm 5.5mm

L5230-32 3.25mm 6mm

L5230-40 4.0mm 7mm

L5230-60 6.0mm 9.5mm

L5230-70 7.0mm 14mm

L5230-90 9.0mm 17mm

angled, tufnol handle, 250mm

L5231-20 2.0mm 4mm

L5231-25 2.5mm 4.5mm

L5231-27 2.75mm 4.5mm

L5231-30 3.0mm 5.5mm

L5231-32 3.25mm 6mm.

L5231-40 4.0mm 7mm

L5231-60 6.0mm 9.5mm

L5231-70 7.0mm 14mm

L5231-90 9.0mm 17mm

Dissecting Forceps

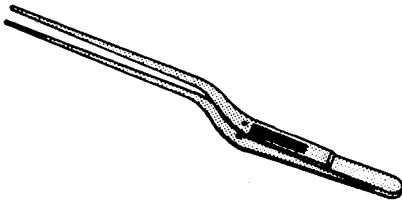

Adson Bayonet
serrated, fine
L5240-19 190mm

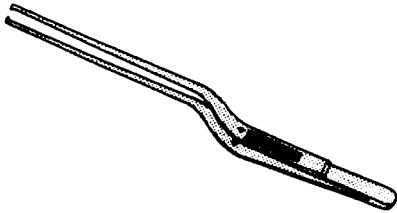

Adson Bayonet
1/2 teeth
L5241-19 190mm



Cairns
delicate, 2/3 teeth
L5245-16 165mm
L5245-21 215mm



Dott
fine, 1/2 teeth
L5250-17 175mm



Jefferson
fine, 1/2 teeth
L5255-17 175mm



Pennybacker
3/4 teeth
L5260-16 165mm

Dissectors

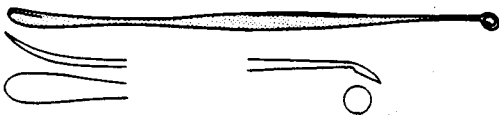

Penfield
fig 1
L5270-17 175mm

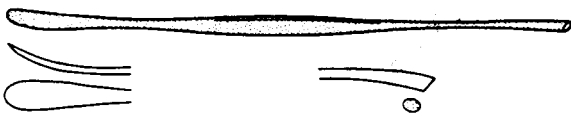

Penfield
fig 2
L5270-19 195mm

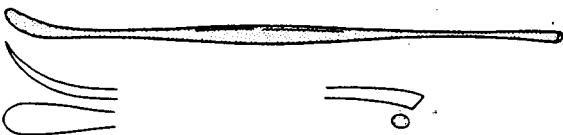

Penfield
fig 3
L5270-20 195mm



Dissectors

**Penfield**

fig 4
L5270-21 215mm

**Penfield**

fig 5
L5270-29 290mm

**Pennybacker**

double ended
L5270-25 225mm

**Swedish**

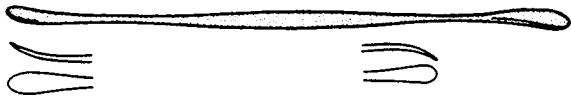
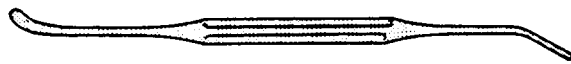
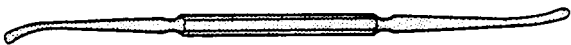
double ended
L5280-17 175mm

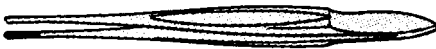
**Cairns**

fine, serrated jaws
L5290-18 180mm

**Cairns**

medium, serrated jaws
L5290-21 215mm

**Jefferson**

serrated jaws
L5295-18 180mm

Dural Forceps

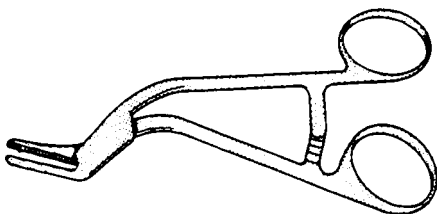
**Adson**

drill guide and dura protector, jaw opening 19mm to 6mm
L5300-15 150mm

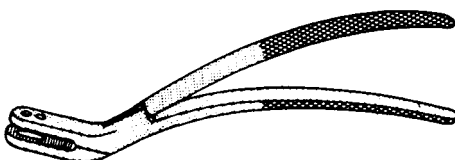
**Adson**

skull drill guide and dura protector, for drills to 3mm diameter
L5301-19 190mm

Dural Hooks

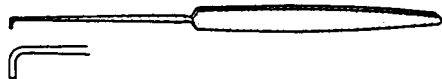

Adson
blunt
L5305-19 190mm



Adson
fine, sharp
L5306-19 190mm



Cairns
fine, sharp
L5310-12 125mm



Cairns
sharp
L5311-12 125mm



Krayenbuhl Nerve
large, blunt end
L5315-17 185mm



Krayenbuhl Nerve
probe tip
L5315-19 190mm



Krayenbuhl Nerve
small end pointed
L5315-18 185mm



Nerve
L5320-25 250mm

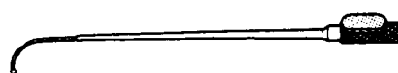

Yasargil
large angle
L5325-17 185mm

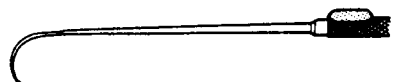

Yasargil
large curve
L5325-18 185mm

Dural Hooks

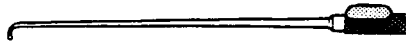

Yasargil
small angle
L5325-19 185mm

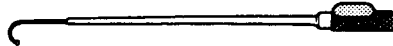

Yasargil
small curve
L5325-21 185mm

Elevators



Adson Periosteal
straight
L5335-16 165mm 7mm wide

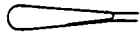

Adson Periosteal
curved
L5336-16 165mm 5mm wide
L5336-17 165mm 7mm wide



Cobb
L5340-26 275mm 10mm
L5340-27 275mm 13mm
L5340-28 275mm 19mm



Pennybacker
curved, sharp
L5345-17 170mm 6mm wide



Gouges



Capener
cranked, tufnol handle, length 235mm
L5355-06 6mm
L5355-08 8mm
L5355-11 11mm
L5355-16 16mm

Guides



Cairns Director
malleable
L5360-12 125mm

Manometer

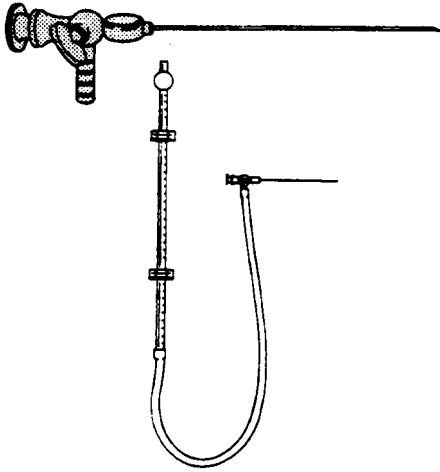
**Greenfield**

300mm tube, 2 needles with stopcocks, 2 level markers and tubing
L5365-30 complete in case
L5365-31 spare needle

Needleholders

**Micro**

straight, without catch
L5375-12 120mm
L5375-18 185mm
 curved, without catch
L5376-12 120mm
L5376-18 185mm
 angled on flat, without catch
L5377-12 120mm

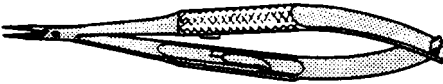
**Micro**

straight, with catch
L5378-12 120mm
L5378-18 185mm
 curved, with catch
L5379-12 120mm
L5379-18 185mm
 angled on flat, with catch
L5380-12 120mm

Neurosurgical Forceps

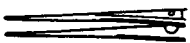
**Bi-Polar**

straight, 165mm
L5390-16 pointed jaw
 straight, 165mm
L5390-17 1 mm jaw
 curved, 165mm
L5391-16 pointed jaw
 curved, 165mm
L5391-18 1 mm jaw

Bi-Polar

angled, 165mm
L5392-16 fine pointed jaw

Neurosurgical Forceps



Bi-Polar
bayonet, 165mm
L5393-16 fine pointed jaw



Bi-Polar
angled, 165mm
L5392-17 pointed jaw



Bi-Polar
bayonet, 165mm
L5393-17 pointed jaw



Bi-Polar
bayonet, 165mm
L5393-18 1 mm jaw



Finger Grip
L5400-01 straight



L5401-01 straight, cup shape



L5402-01 upward curve



L5403-01 upward curve, cup shape



Micro
straight
L5410-12 120mm
L5410-15 150mm
L5410-18 180mm

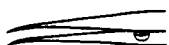

curved
L5411-12 120mm
L5411-15 150mm
L5411-18 180mm



Neurosurgical Instruments

**Yasargil Dissector**

angled, square end

L5425-18 185mm

angled, broad point

L5425-19 185mm

shallow curve, oval end

L5425-20 185mm

curved, oval end

L5425-21 185mm**Yasargil Dissector**

cranked shaft, curved, oval end

L5425-22 185mm

cranked shaft, curved inwards, oval end

L5425-23 185mm

cranked shaft, curved outwards, oval end

L5425-24 185mm

cranked shaft, scoop end

L5425-25 185mm**Olivecrona**

straight

L5435-23 230mm**Olivecrona**

curved

L5436-20 200mm

Neurosurgical Scissors



Finger Grip

- L5445-01 straight
- L5446-01 upward curve

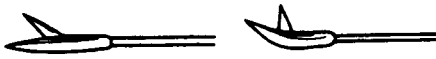

Micro

- straight
- L5450-16 160mm
- L5450-18 185mm

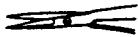

- straight, saw edge
- L5451-16 160mm

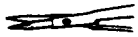

- straight, triangular blade
- L5452-16 160mm



- curved
- L5453-16 160mm
- L5453-18 185mm

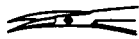

- curved, saw edge
- L5454-16 160mm

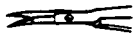

- curved triangular blade
- L5455-16 160mm



Micro

- angled on flat
- L5456-18 185mm

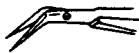

Retractors

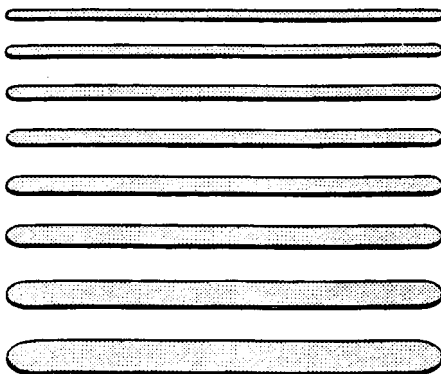

Cairns Strip

- malleable
- L5470-06 200mm 6mm
- L5470-0S 200mm 8mm
- L5470-10 200mm 10mm
- L5470-11 200mm 11 mm
- L5470-13 200mm 13mm
- L5470-16 200mm 16mm
- L5470-19 200mm 19mm
- L5470-25 200mm 25mm

Retractors

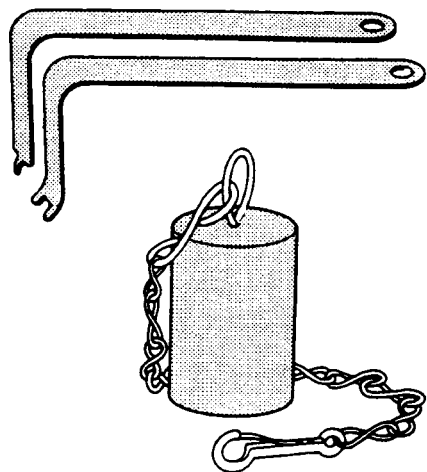
**Charnley**

set of 2, one with central hook and one with 2 blunt hooks together
with spain weight (1.47kg) and chain
L5475-65 65mm 175mm

**Cushing**

L5480-19 190mm
L5480-28 280mm

**Dandy**

straight
L5485-20 200mm

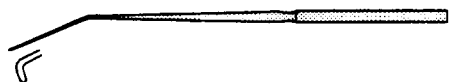

curved to left
L5486-20 200mm

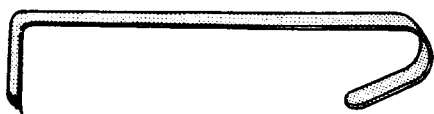

curved to right
L5487-20 200mm

**Hibbs**

200mm
L5495-10 10mm 38mm blades
L5495-16 16mm 54mm blades
L5495-25 25mm 70mm blades

**Love**

nerve root
L5500-01 straight
L5501-01 angled
L5502-01 right angled

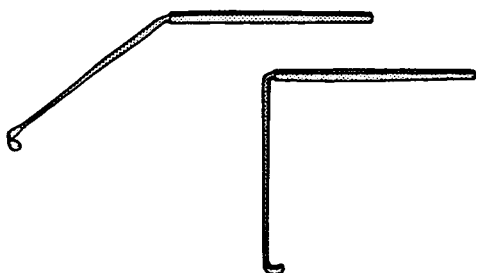
**O'Connell**

double ended
L5510-21 215mm

Retractors, Self-Retaining

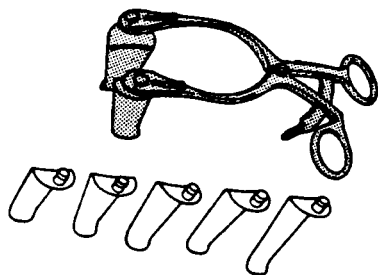
**Cloward**

complete with 5 blades
L5515-15 150mm

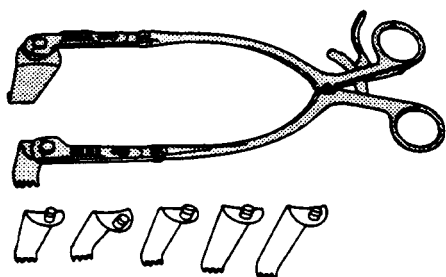
**Cloward**

hinged, complete with 5 blades
L5517-24 240mm

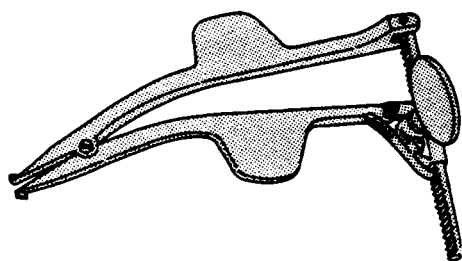
**Cloward**

with thumb screw
L5520-15 150mm

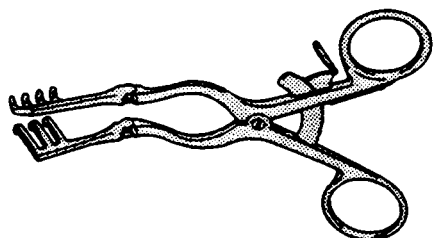
**Cone**

blunt, 3/4 prong
L5525-12 125mm
L5525-16 160mm
L5525-20 200mm
L5525-26 260mm
sharp, 3/4 prong
L5526-12 125mm
L5526-16 160mm
L5526-20 200mm
L5526-26 260mm

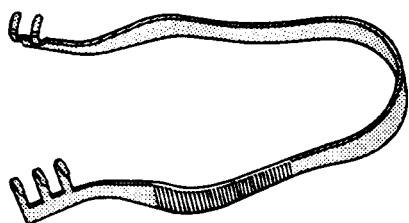
**Finsen**

blunt
L5535-50 50mm
L5535-70 70mm
sharp
L5536-50 50mm
L5536-70 70mm

Retractors Self-Retaining

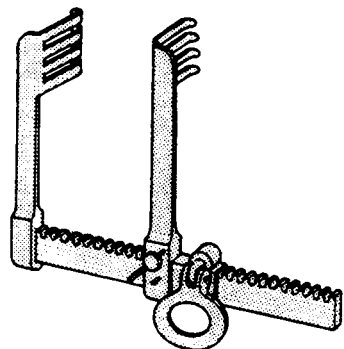
**Harris Laminectomy**

self locking, 130mm arms
L5545-38 38mm 50mm blades

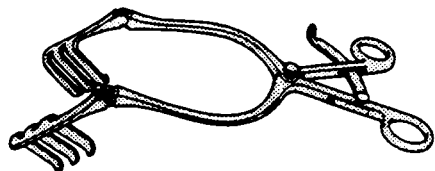
**Harvey-Jackson**

hinged arms, 305mm
L5550-38 38mm 44mm blades

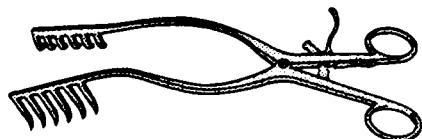
**Hemilaminectomy**

sharp, 6/6 prong
L5555-27 270mm

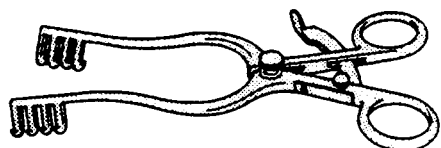
**Henderson**

blunt
L5560-13 135mm

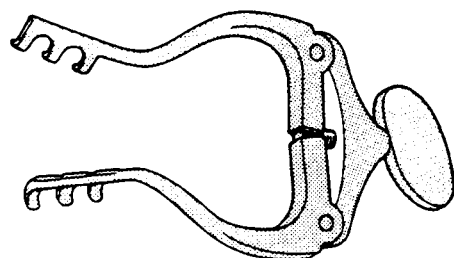
**Jansen**

blunt
L5565-11 112mm

Retractors Self-Retaining

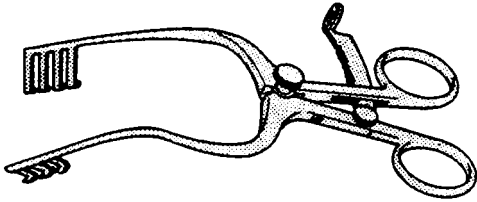
**Jefferson**

curved, blunt, 3/4 prong
L5575-14 140mm

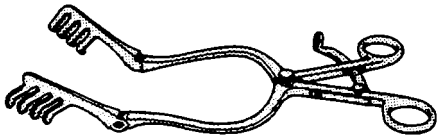
**Mayo-Adson**

hinged arms
L5580-29 290mm

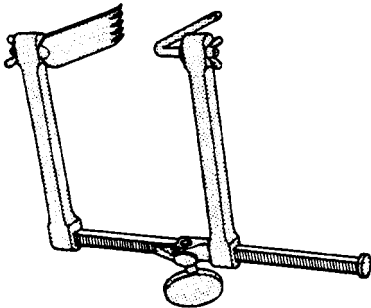
**Scoville**

straight arms, 1 hook blade
L5590-25 25mm 65mm retractor blade

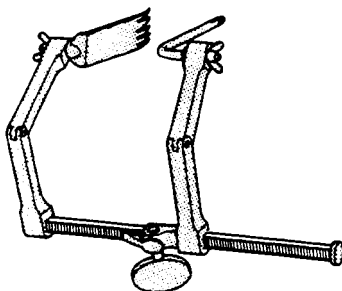
**Scoville**

With hinged arms
L5595-25 25mm 65mm retractor blade

Rongeurs

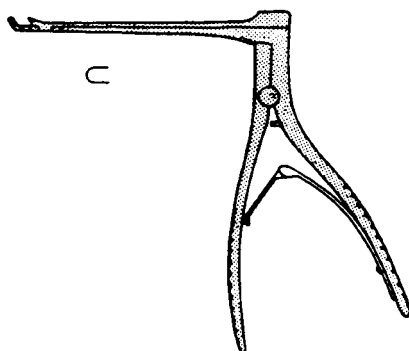
**Bateman**

40° upward cutting, 150mm effective length
L5620-03 3mm bite

Rongeurs

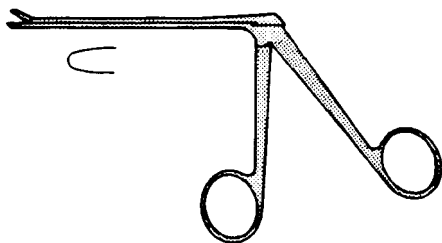
**Beck**

130mm effective length
L5625-02 2mm bite

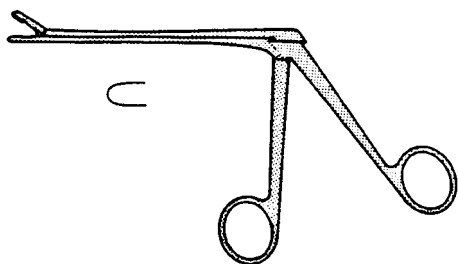
**Cushing**

straight, 130mm effective length
L5630-04 4mm bite
L5630-05 5mm bite
L5630-07 7mm bite

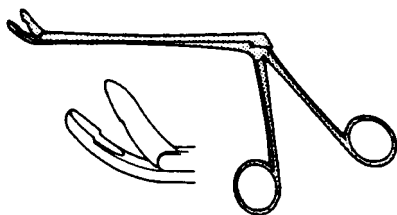
**Cushing**

angled upward, 130mm effective length
L5631-03 3mm bite
L5631-04 4mm bite
L5631-05 5mm bite

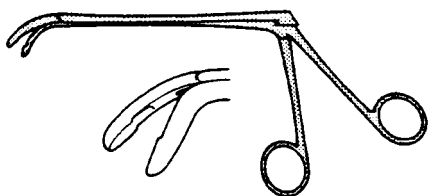
**Cushing**

angled downward, 130mm effective length
L5632-03 3mm bite
L5632-04 4mm bite

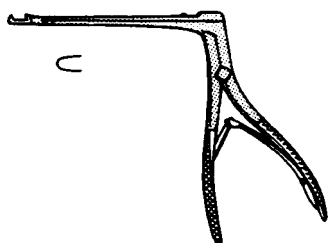
**Falconer**

upward cutting, 140mm effective length
L5640-03 3mm bite
L5640-05 5mm bite

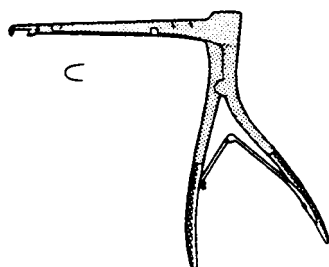
**Falconer**

downward cutting, 140mm effective length
L5641-03 3mm bite
L5641-05 5mm bite

Rongeurs

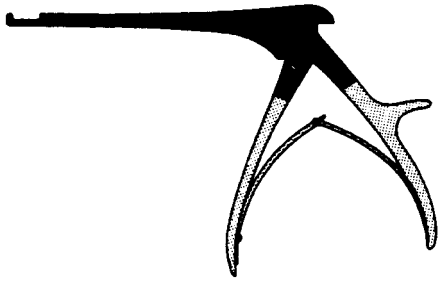
**Kerrison**

upward cutting, 150mm effective length

L5670-03 3mm bite

L5670-04 4mm bite

L5670-05 5mm bite

upward cutting, 180mm effective length

L5671-02 2mm bite

L5671-03 3mm bite

upward cutting, 200mm effective length

L5672-03 3mm bite

L5672-04 4mm bite

L5672-05 5mm bite

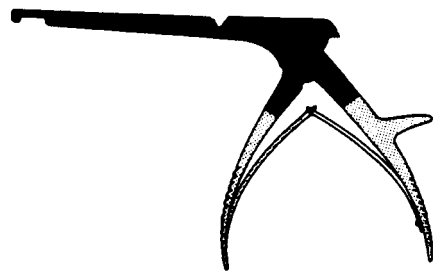
**Kerrison**

downward cutting, 150mm effective length

L6674-03 3mm bite

L5674-04 4mm bite

L5674-05 5mm bite

downward cutting, 180mm effective length

L5675-02 2mm bite

L5675-03 3mm bite

downward cutting, 200mm effective length

L5676-03 3mm bite

L5676-04 4mm bite

L5676-05 5mm bite

40° downward cutting, 180mm effective length

L5677-03 3mm bite

L5677-04 4mm bite

L5677-05 5mm bite

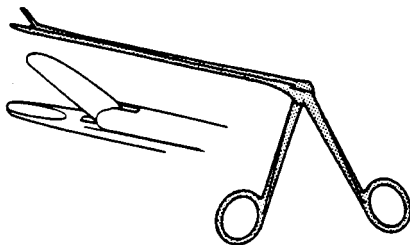
**Love-Grunwald**

straight, 180mm effective length

L5685-03 3mm bite

curved upward, 180mm effective length

L5686-03 3mm bite

curved downward, 180mm effective length

L5687-03 3mm bite

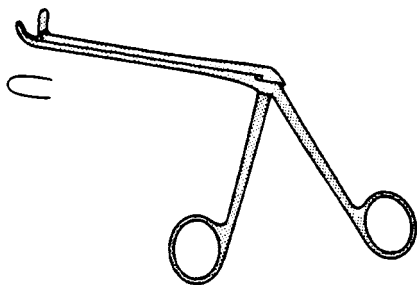
**Northfield**

curved upward, 130mm effective length

L5690-04 4mm bite

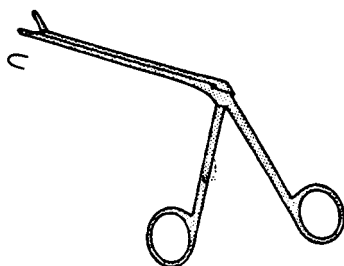
**Pennybacker**

straight, 115mm effective length

L5695-03 3mm bite

Rongeurs

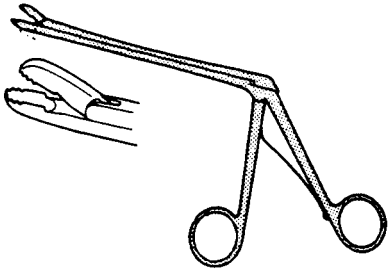
**Pituitary**

straight, with teeth, 135mm effective length

L5705-04 4mm bite

L5705-05 5mm bite

L5705-06 6mm bite

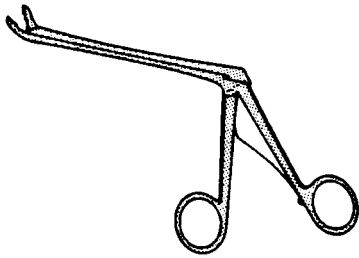
**Pituitary**

curved with teeth, 135mm effective length

L5706-04 4mm bite

L5706-05 5mm bite

L5706-06 6mm bite

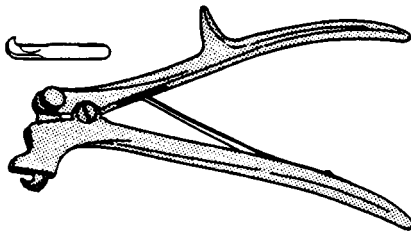
**Devilbiss**

cranial

L5710-21 210mm

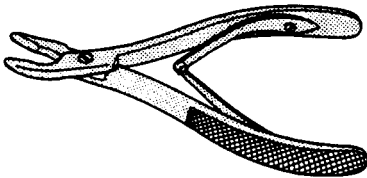
**Glasgow**

curved on flat, screw joint, 145mm

L5715-04 4mm bite

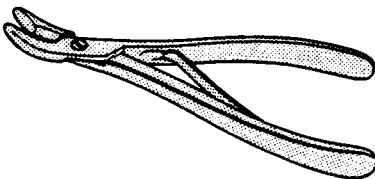
**Jansen**

small curve, screw joint, 150mm

L5720-08 8mm bite

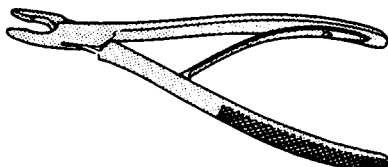
**Northfield**

straight, 200mm

L5725-10 10mm bite

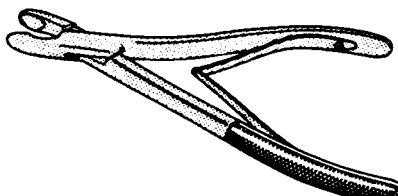
**Pennybacker**

straight, fine jaw, 200mm

L5730-04 4mm bite

Rongeurs

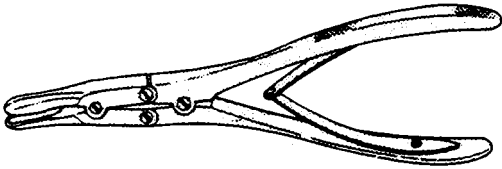
**Ruskin**

curved on flat, compound action, 185mm
L5735-06 6mm bite

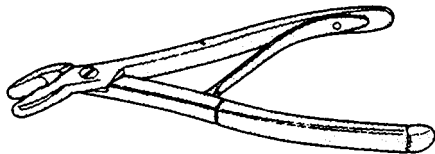
**Trotter**

angled to side, screw joint, 200mm
L5745-10 10mm bite

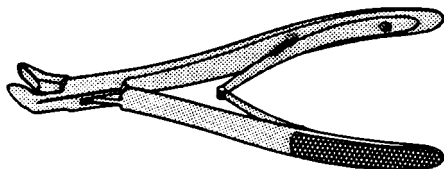
**Wilms**

angled on flat, 200mm
L5765-04 4mm bite

Saws

**De Martel Gigli Guide**

L5780-30 305mm

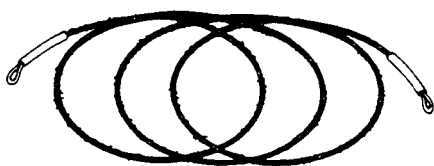
**Gigli**

L5785-30 305mm
L5785-50 500mm

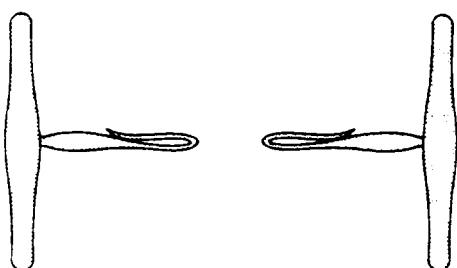
**Gigli Handle**

Pair
L5790-50 50mm

Scissors

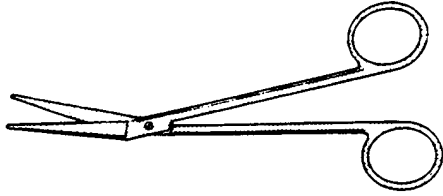

Cairns
angled on flat
L5800-17 175mm



Dandy
L5810-17 170mm



Demartel
angled to side
L5820-21 210mm

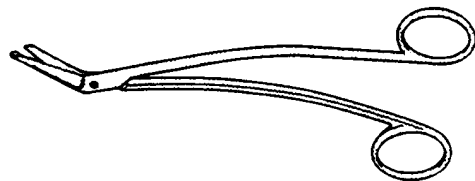

Schmieden-Taylor
L5830-14 145mm
L5830-17 170mm

Shears

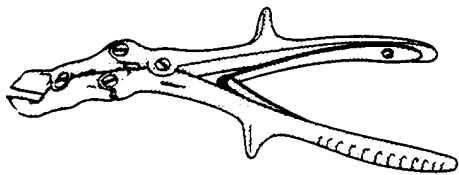

Swedish Laminectomy
compound action
L5840-26 265mm

Suction Tubes



Adson
slight curve
L5870-15 155mm

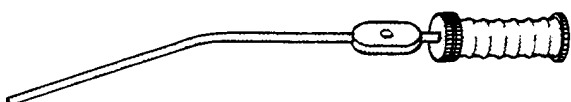

Adson Frazier
angled, 175mm
L5880-07 7fg, 2.3mm
L5880-08 8fg, 2.7mm
L5880-09 9fg, 3.0mm

Suction Tubes

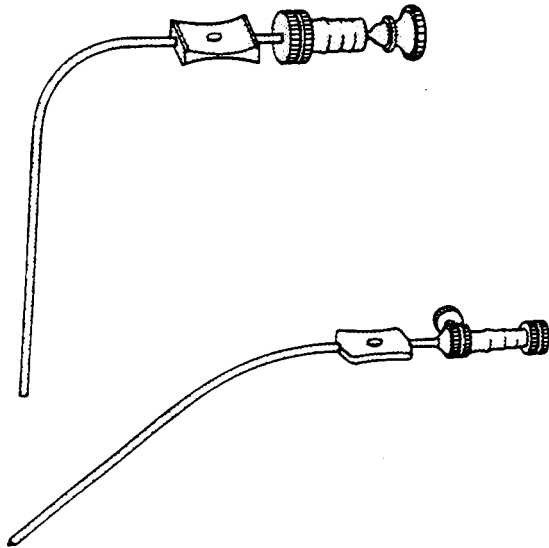
**Falconer**

right angled, 165mm
L5890-07 7fg, 2.3mm

Frazier

malleable, angled, 180mm
L5900-07 7fg, 2.3mm
L5900-08 8fg, 2.7mm
L5900-09 9fg, 3.0mm

Suture Instruments

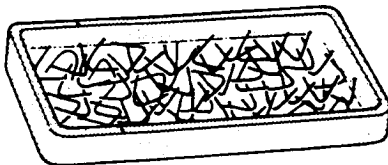
**Brain Clips**

box of 100
L5910-01 silver

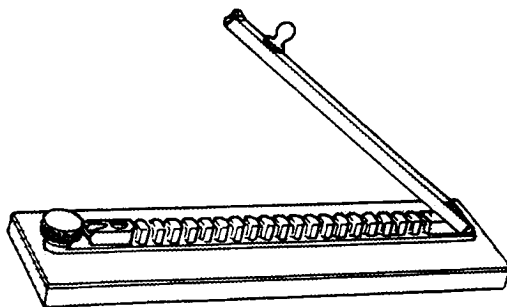
**McKenzie**

to hold silver brain clips
L5920-01 single

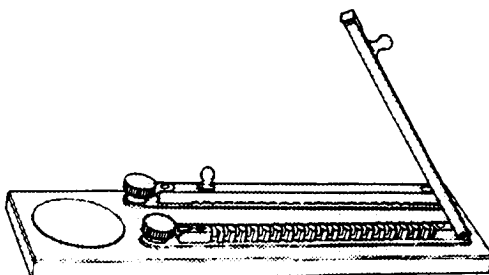
**McKenzie**

to hold silver brain clips
L5920-02 double

Suture Instruments

**Michel Clips**

box of 100
L5930-12 12mm
L5930-14 14mm
L5930-16 16mm

**Raney**

L5940-01 scalp clip

Syringe

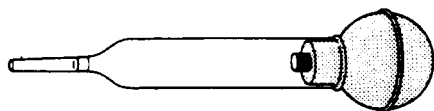
**Dakin**

L5945-01 complete with valve

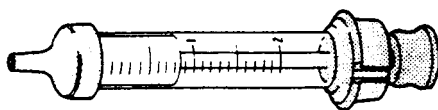
**Luer**

L5950-02 2ml

Traction Apparatus

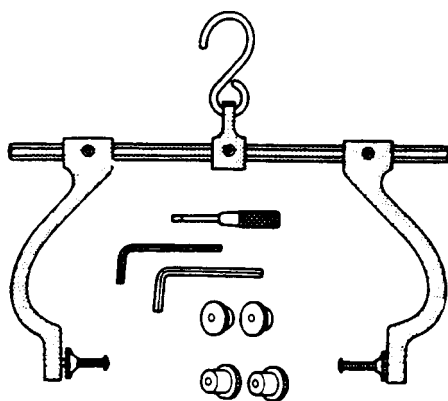
**Blackburn**

with washers, allen key and screwdrivers
L5960-01

Traction Tongs

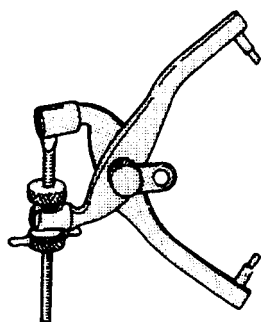
**Crutchfield**

L5965-01 for children

Traction Tongs

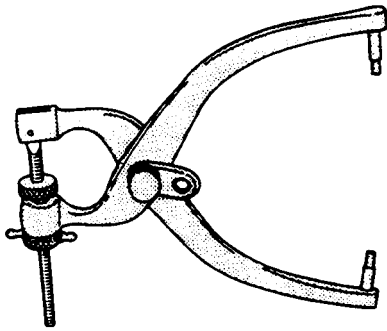

Crutchfield
L5965-02 medium size

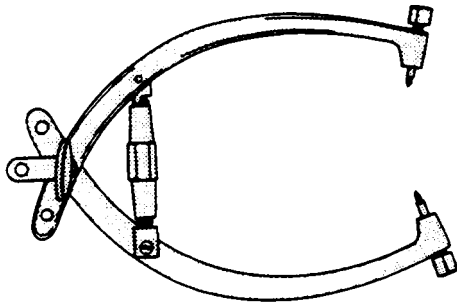

Cervical
L5965-03 large size

Trepines

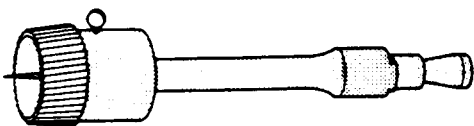

Rowbotham
L5975-19 19mm
L5975-25 25mm

ORTHOPAEDIC SURGERY

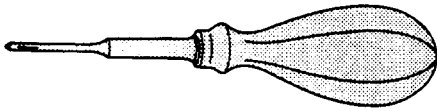

Awls

**Bone**

straight with eye

L6075-20	2.0mm diameter, 125mm
L6075-24	2.4mm diameter, 130mm
L6075-28	2.8mm diameter, 145mm
L6075-32	3.2mm diameter, 160mm
L6075-36	3.6mm diameter, 165mm
L6075-40	4.0mm diameter, 175mm

Bone Curettes

**Bruns**

L6080-01	000
L6080-02	00
L6080-03	0
L6080-11	1
L6080-12	2
L6080-13	3
L6080-14	4
L6080-15	5
L6080-16	6

**Stanley Boyd**

double ended

L6090-15	small, 150mm
L6090-20	medium, 200mm
L6090-25	large, 250mm

**Volkmann**

double ended, 220mm

L6095-01	small
L6095-02	medium
L6095-03	large

**Volkmann**

single end

L6096-01	No.1
L6096-02	No.2
L6096-03	No.3
L6096-04	No.4
L6096-05	No.5
L6096-06	No.6

Bone Cutting Forceps

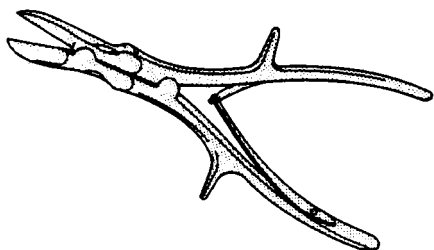
**Horsley**

compound action, straight

L6100-25 255mm

compound action, curved

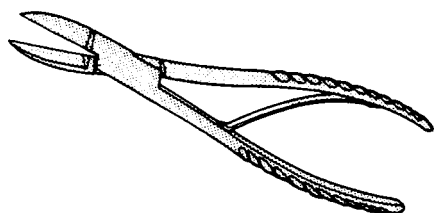
L6101-25 255mm**Liston**

straight

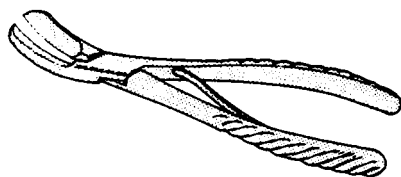
L6105-15 150mm**L6105-18** 180mm**L6105-20** 200mm**L6105-23** 230mm**Liston**

curved

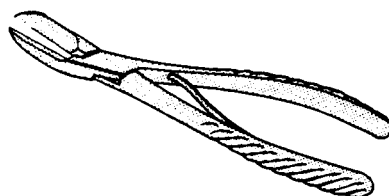
L6106-15 150mm**L6106-18** 180mm**L6106-20** 200mm**L6106-23** 230mm**Liston**

angled

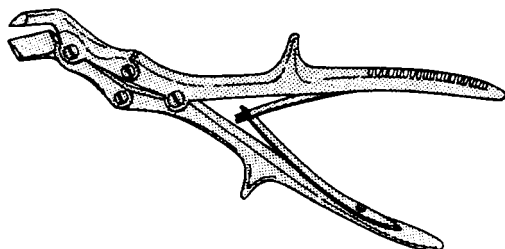
L6107-15 150mm**L6107-18** 180mm**L6107-20** 200mm**L6107-23** 230mm**Liston-Key**

compound action

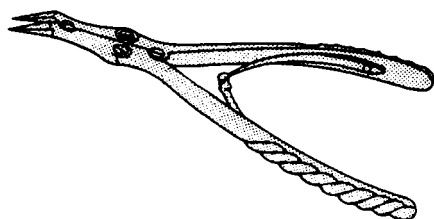
L6110-27 270mm**McIndoe**

compound action

L6115-19 190mm

Bone Cutting Forceps

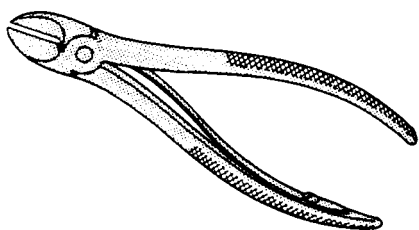

Paton
L6120-14 140mm

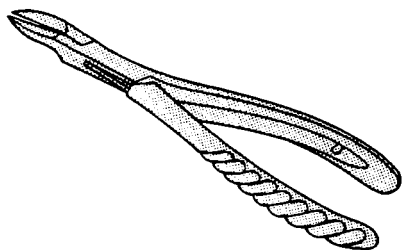

Stamm
L6125-14 140mm

Bone Holding Clamps

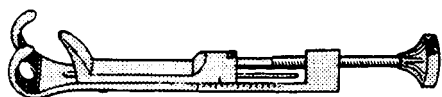

Lowman
L6130-12 120mm
L6130-17 170mm
L6130-20 200mm
L6130-22 220mm

Bone Holding Forceps

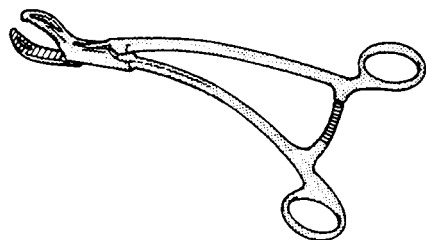

Burns
L6135-19 190mm

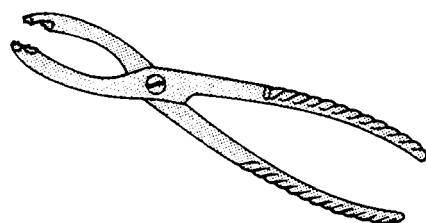

Fergusson
screw joint
L6140-15 150mm
L6140-20 200mm

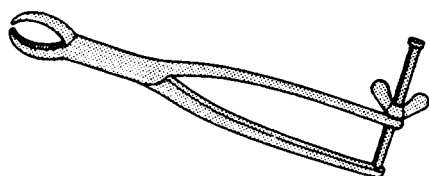

Hey Groves
L6145-20 200mm
L6145-25 255mm
L6145-30 305mm

Bone Holding Forceps

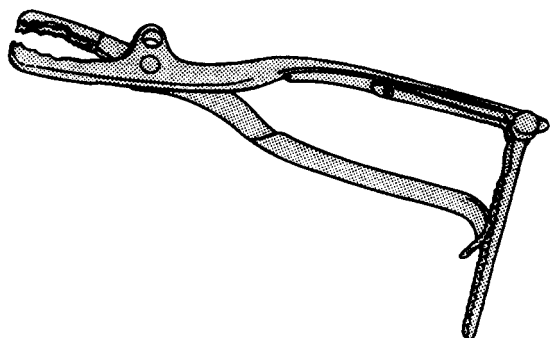
**Lambotte**

with rack
L6150-26 260mm

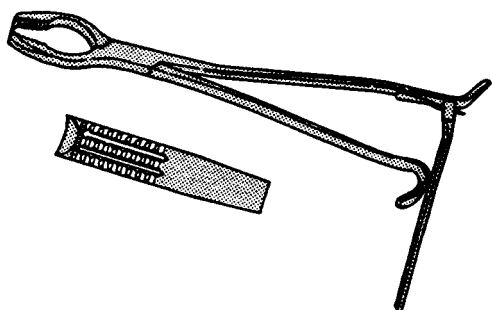
**Lane**

with rack
L6155-33 330mm
L6155-45 450mm

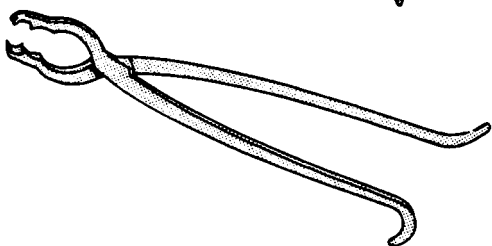
**Lane**

without rack
L6156-32 320mm
L6156-39 395mm

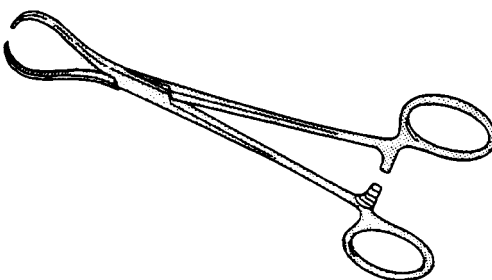
**Lewin**

L6160-17 175mm

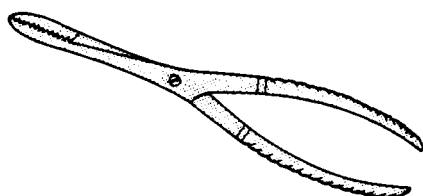
**Necrosis (Sequestrum)**

straight, screw joint
L6165-19 190mm
L6165-20 200mm

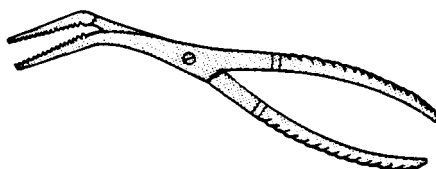
**Necrosis (Sequestrum)**

angled, screw joint
L6166-19 190mm
L6166-20 200mm

Bone Holding Forceps

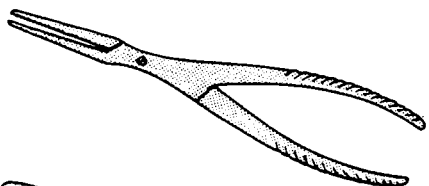
**Necrosis (Sequestrum)**

long fine jaws, screw joint
L6167-20 200mm

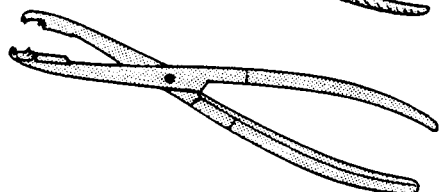
**St Thomas**

screw joint
L6170-17 175mm

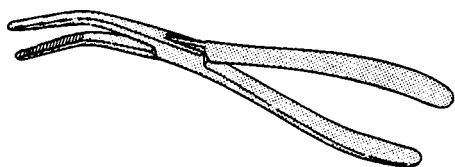
**Van Buren**

L6175-23 230mm

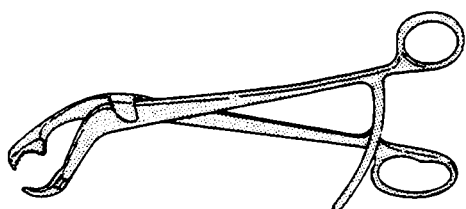
**Verbrugge**

L6180-2~ 250mm, 9.5mm jaw
L6180-26 260mm, 10.5mm jaw
L6180-27 270mm, 12mm jaw

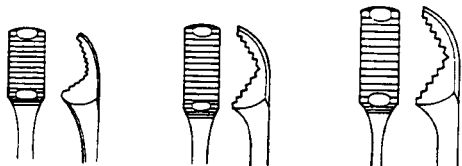

Bone Hooks

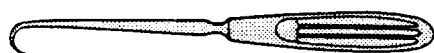
**Langenbeck**

L6131-21 215mm

Bone Levers

**Bankhart**

L6185-30 300mm

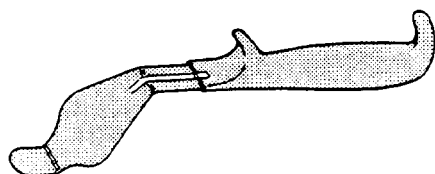
**Bennett**

L6190-24 240mm

Bone Levers

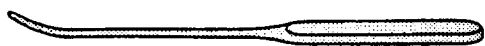
**Lane**

heavy, solid handle
L6195-35 355mm

**Lane**

ring handle
L6196-26 265mm

**Lane**

serrated end
L6197-26 260mm

**Murphy Skid**

L6200-33 330mm

**Trethowan**

ring handle
L6205-21 215mm

Bone Plates

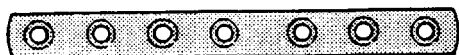
**Compression**

narrow, 11 mm wide 4mm thick, length:

L6215-04 39mm, 2 holes
L6215-06 55mm, 3 holes
L6215-07 70mm, 4 holes
L6215-09 90mm, 5 holes
L6215-11 105mm, 6 holes
L6215-12 120mm, 7 holes
L6215-13 135mm, 8 holes
L6215-15 155mm, 9 holes
L6215-16 165mm, 10 holes
L6215-18 185mm, 11 holes
L6215-20 200mm, 12 holes
L6215-21 215mm, 13 holes
L6215-23 230mm, 14 holes
L6215-24 245mm, 15 holes
L6215-26 265mm, 16 holes

**Compression**

broad, 16mm wide 4mm thick, length:

L6216-09 90mm, 5 holes
L6216-10 105mm, 6 holes
L6216-12 120mm, 7 holes
L6216-13 135mm, 8 holes
L6216-15 150mm, 9 holes
L6216-17 170mm, 10 holes
L6216-20 200mm, 12 holes
L6216-23 230mm, 14 holes
L6216-26 265mm, 16 holes

Bone Plates

**Compression**

finger, 1mm thick, length

L6217-17	17mm, 2 holes
L6217-25	25mm, 3 holes
L6217-33	33mm, 4 holes
L6217-49	49mm, 6 holes
L6217-65	65mm, 8 holes
L6217-80	80mm, 10 holes

**Compression**

one-third tubular, length:

L6218-25	25mm, 2 holes
L6218-37	37mm, 3 holes
L6218-50	50mm, 4 holes
L6218-60	60mm, 5 holes
L6218-75	75mm, 6 holes
L6218-85	85mm, 7 holes
L6218-95	95mm, 8 holes

semi-tubular length:

L6219-04	40mm, 2 holes
L6219-05	55mm, 3 holes
L6219-07	70mm, 4 holes
L6219-08	85mm, 5 holes
L6219-10	105mm, 6 holes
L6219-12	120mm, 7 holes
L6219-13	135mm, 8 holes
L6219-15	150mm, 9 holes
L6219-16	165mm, 10 holes
L6219-18	185mm, 11 holes
L6219-20	200mm, 12 holes

**McLaughlin**

L6225-13	3 holes
L6225-15	5 holes
L6225-17	7 holes
L6225-22	12 holes

**McLaughlin****L6225-23** screw to fit**Smith Petersen**

L6230-30	3 holes
L6230-50	5 holes
L6230-70	7 holes

**Smith Petersen****L6230-75** screw to fit

Bone Screws Burs



Carpal Scaphoid

4mm diameter

L6235-10 lengths available from 10mm to 40mm



Cortex

3.5mm diameter

L6238-10 lengths available from 10mm to 28mm



Cortex Compression

4.5mm diameter

L6241-12 lengths available from 12mm to 70mm

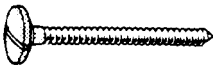

Cortex Finger

2.7mm diameter

L6244-08 lengths available from 8mm to 24mm



Malleolus

4.5mm diameter

L6247-25 lengths available from 25mm to 70mm

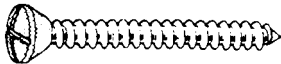

Shermann

4.0mm diameter

L6250-10 lengths available from 10mm to 120mm

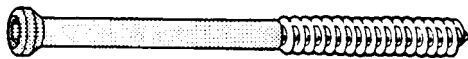

Spongiosa

long thread, 6.5mm diameter

L6253-30 lengths available from 30mm to 110mm

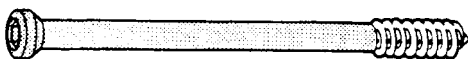

Spongiosa

short thread, 6.5mm diameter

L6254-25 lengths available from 25mm to 110mm

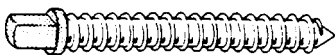

Square Head

4mm diameter

L6257-30 lengths available from 30mm to 60mm.

Bone Screws

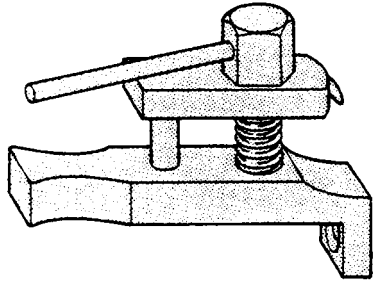
**Instruments**

compression device
L6260-01 for bone plates

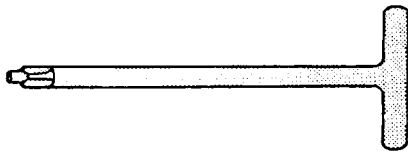
**Instruments**

L6265-01 countersink

**Instruments**

depth calibrator, graduated to 50mm
L6270-18 185mm

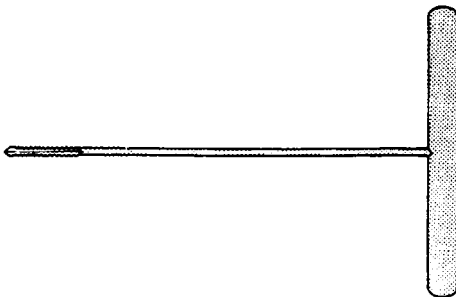
**Instruments**

gimlet
L6275-36 3.6mm diameter
L6275-40 4.0mm diameter
L6275-45 4.5mm diameter
L6275-65 6.5mm diameter

**Instruments**

twist drill
L6280-20 2.0mm diameter
L6280-28 2.8mm diameter
L6280-32 3.2mm diameter
L6280-35 3.5mm diameter
L6280-40 4.0mm diameter
L6280-45 4.5mm diameter
L6280-50 5.0mm diameter

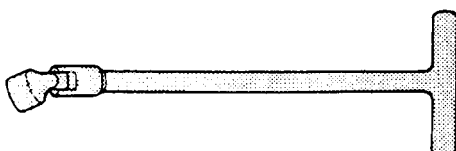
**Instruments**

L6285-01 wrench

Burs

**Paton**

155mm

L6290-35 3.5mm diameter**L6290-45** 4.5mm diameter**L6290-50** 5.0mm diameter

Calipers

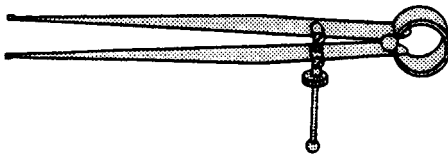
**Albee**

bone graft, nickel plated

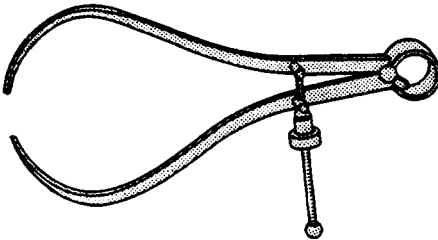
L6295-17 170mm**Albee**

bone, nickel plated

L6296-18 180mm

Cartilage Forceps

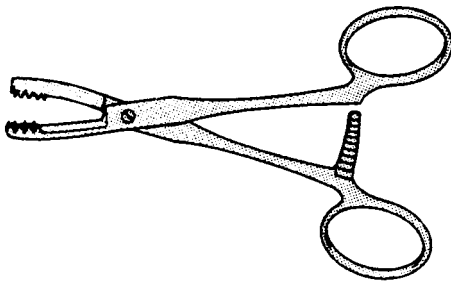
**Martin**

screw joint

L6300-16 165mm

Chisels

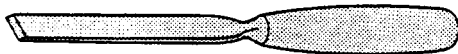
**Capener**

tufnol handles, length 250mm

L6305-10 10mm**L6305-12** 12mm**L6305-15** 15mm**L6305-20** 20mm**L6305-25** 25mm**L6305-30** 30mm**L6305-35** set of 6**Lambotte**

length 240mm

L6310-15 15mm**L6310-20** 20mm**L6310-25** 25mm**L6310-30** 30mm**L6310-38** 38mm**L6310-44** 44mm**L6310-50** 50mm

Chisels

**Partsch**

length 115mm

L6315-02 2mm**L6315-03** 3mm**L6315-04** 4mm**L6315-05** 5mm**L6315-06** 6mm**L6315-07** 7mm**L6315-08** 8mm

length 135mm

L6316-02 2mm**L6316-03** 3mm**L6316-04** 4mm**L6316-05** 5mm**L6316-06** 6mm**L6316-07** 7mm**L6316-08** 8mm

length 170mm

L6317-02 2mm**L6317-03** 3mm**L6317-04** 4mm**L6317-05** 5mm**L6317-06** 6mm**L6317-07** 7mm**L6317-08** 8mm**Smith Petersen**

length 200mm

L6320-06 6mm**L6320-10** 10mm**L6320-13** 13mm**L6320-15** 15mm**L6320-20** 20mm**L6320-25** 25mm**L6320-30** 30mm**Swedish**

length 200mm

L6325-10 10mm**L6325-15** 15mm**L6325-20** 20mm**L6325-25** 25mm**L6325-30** 30mm**Jackson Burrows**

serrated, 1/2 teeth

L6330-14 140mm**Jackson Burrows**

with tongue and groove in jaw

L6330-15 140mm**Bristow**

periosteal, sharp

L6335-17 175mm

Elevators

Elevators



Cobb
periosteal
L6340-20 200mm



Spinal
305mm
L6345-18 18mm wide

Files



Bone Rasp
combined
L6350-22 220mm



Tubby
L6355-30 305mm

Gouges

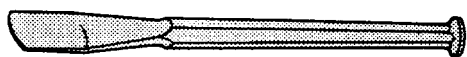

Charnley
L6360-30 length 300mm



Lambotte
length 230mm
L6365-15 15mm
L6365-20 20mm
L6365-25 25mm
L6365-30 30mm
L6365-38 38mm
L6365-44 44mm
L6365-50 50mm



Partsch length 115mm	length 170mm
L6370-02 2mm	L6372-02 2mm
L6370-03 3mm	L6372-03 3mm
L6370-04 4mm	L6372-04 4mm
L6370-05 5mm	L6372-05 5mm
L6370-06 6mm	L6372-06 6mm
L6370-07 7mm	L6372-07 7mm
L6370-08 8mm	L6372-08 8mm
length 135mm	
L6371-02 2mm	
L6371-03 3mm	
L6371-04 4mm	
L6371-05 5mm	
L6371-06 6mm	
L6371-07 7mm	
L6371-08 8mm	



Gouges

**Smith-Petersen**

straight, length 200mm

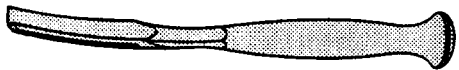
L6375-10 10mm**L6375-15** 15mm**L6375-20** 20mm**L6375-25** 25mm**Smith-Petersen**

concave, length 200mm

L6376-10 10mm**L6376-15** 15mm**L6376-20** 20mm**L6376-25** 25mm**Swedish**

straight, length 200mm

L6380-10 10mm**L6380-15** 15mm**L6380-20** 20mm**L6380-25** 25mm**L6380-30** 30mm**Tufnol Handle**

straight, length 230mm

L6385-10 10mm**L6385-15** 15mm**L6385-20** 20mm**L6385-25** 25mm**L6385-30** 30mm

Guide Wires

Kuntscher**L6390-03** 3mm diameter, for use with 8mm nails, 380mm**L6390-04** 4mm diameter, for use with 9-11 mm nails, 545mm**L6390-05** 5mm diameter, for use with 12mm nails, 545mm

Hand Drills

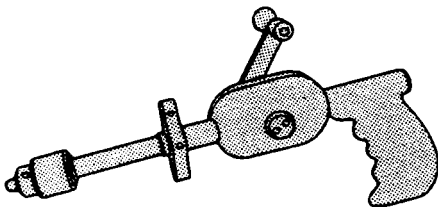
**Pistol Grip**

Jacobs chuck and key

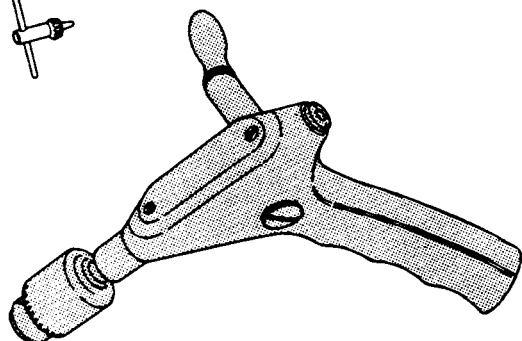
L6395-01 complete**L6395-02** Jacobs chuck key**Ralk**

complete with chuck

L6400-63 opens to 6.35mm

Hand Drills

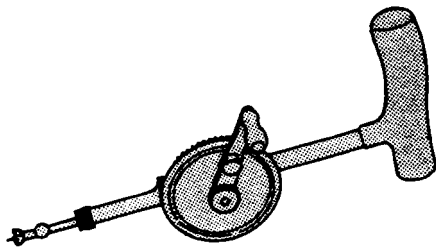

Stille
L6405-24 240mm

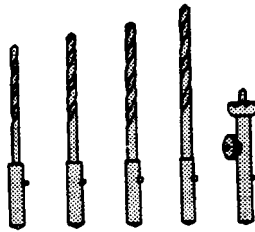

Stille
bits to fit Stille Hand Drill
L6406-25 2.5mm
L6406-30 3.0mm
L6406-35 3.5mm
L6406-40 4.0mm
L6406-90 10.0mm

Hand Splint

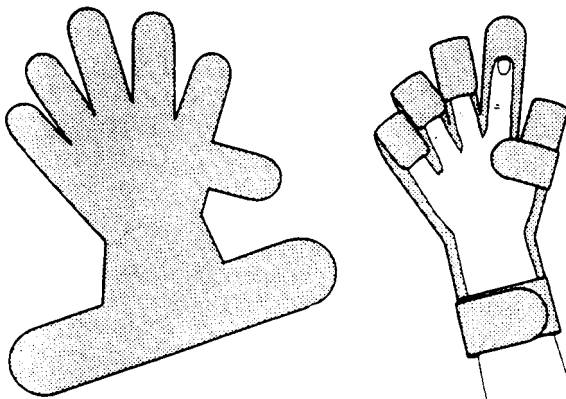

Lead
L6410-37 adult, 370mm 310mm
L6410-27 child, 275mm 160mm

Hip Nails

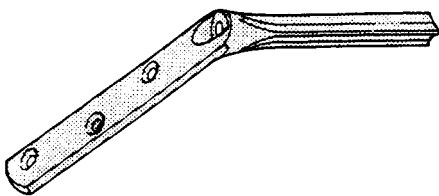

Jewett
plate and nail combined
L6415-75 nail lengths available from 75mm to 150mm, plate
lengths from 75mm to 150mm



Kuntscher
9mm diameter
L6420-11 lengths available from 110mm to 180mm

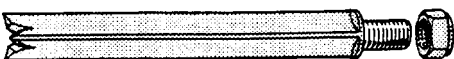

McKee
with screw, 12.7mm diameter
L6425-60 lengths available from 60mm to 160mm

Hip Nails

**Smith Petersen**

12.7mm diameter

L6430-60 lengths available from 60mm to 160mm

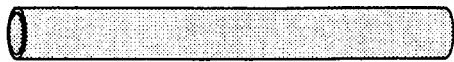
**Driver**

L6435-01 driver

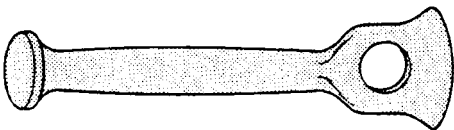
**Impactor**

L6435-02 impactor

**Starter**

L6435-03 starter

Hip Screws

**Leinbach**

4.5mm diameter

L6440-10 lengths available from 100mm to 150mm

**Lorenzo**

9.5mm diameter

L6445-65 lengths available from 65mm to 135mm

Knives

**Adams Tenotomy**

L6450-01 fig 1, 145mm

**Adams Tenotomy**

L6450-02 fig 2, 140mm

**Adams Tenotomy**

L6450-03 fig 3, 140mm

**Adams Tenotomy**

L6450-04 fig 4, 135mm

Knives

**Guy's Tenotomy**

L6455-14 140mm

**Jones Tenotomy**

L6460-13 135mm

**McMurray Tenotomy**

L6465-13 135mm

**Monro Menisectomy**

L6470-17 175mm

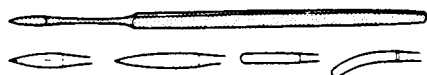
**Parker Tenotomy**

L6475-01 fig 1, 13mm blade

L6475-02 fig 2, 20mm blade

L6475-03 fig 3, 13mm blade

L6475-04 fig 4, 15mm blade

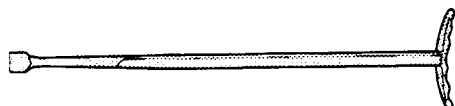
**Smillie Menisectomy**

L6480-01 straight, 175mm

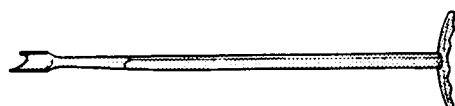
**Smillie Menisectomy**

L6480-02 curved to left, 175mm

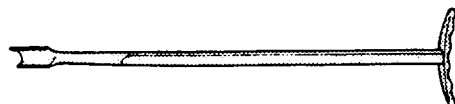
**Smillie Menisectomy**

L6480-03 curved to right. 175mm

**Tenotomy**

blunt

L6485-30 30mm blade

**Tenotomy**

sharp

L6485-31 30mm blade

**Tubby Tenotomy**

L6490-13 135mm

Mallets

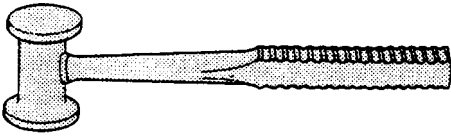
**Bergmann**

240mm, 45mm diameter
L6500-30 300grms

**Brass**

160mm, 20mm diameter
L6505-14 140grms

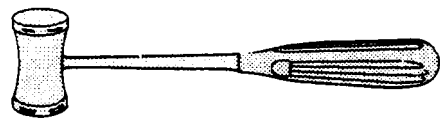
**Hajek**

220mm, 27mm diameter
L6510-14 140grms

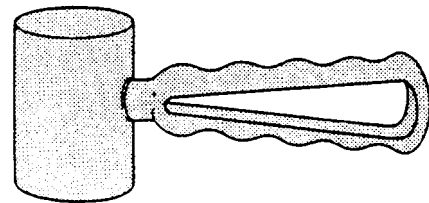
**Heath**

copper head, electro plated
L6515-18 18oz
L6515-28 28oz
L6515-32 32oz
L6515-36 36oz

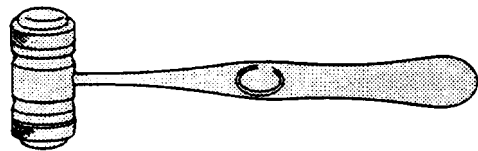
**Mead**

170mm, 26mm diameter, with interchangeable faces
L6520-32 320grms

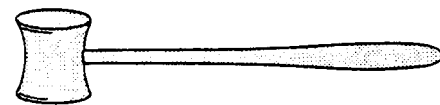
**Stainless steel**

L6525-08 8oz

Nail Instruments

**Driver/Extractor**

hook end round medullary nails 170mm
L6530-24 2.4mm
L6530-32 3.2mm
L6530-47 4.7mm
L6530-63 6.3mm

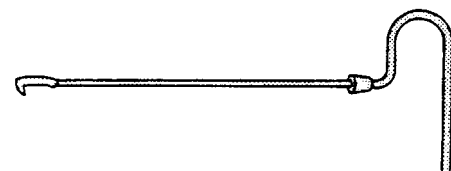
**Kuntscher Extractor**

for use with Kuntscher Hammer
L6535-33 330mm

Nail Instruments

**Kuntscher Hammer**

with slotted head, for use with Kuntscher Extractor
L6536-28 280mm

**Kuntscher Punch**

L6540-12 120mm

**Perthes**

twist Drill

L6545-24 2.4mm

L6545-32 3.2mm

L6545-47 4.75mm

L6545-63 6.35mm

**Reamer**

medullary canal

L6550-08 8mm

L6550-09 9mm

L6550-10 10mm

L6550-11 11 mm

**Reamer**

flexible

L6551-06 6mm

L6551-07 7mm

L6551-08 8mm

L6551-09 9mm

L6551-10 10mm

L6551-11 11 mm

L6551-12 12mm

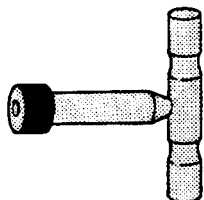
**Reamer**

handle

L6552-01 for flexible reamer

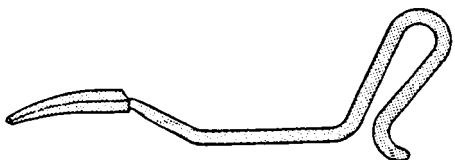
**Reamer**

inter-medullary

L6555-26 265mm

Nail Plates

**Blount**

blade length plate length

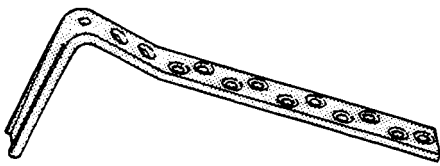
L6560-07 90mm 75mm, 3 holes**L6560-10** 90mm 100mm, 4 holes**Condylar**

95° blade length plate length

L6565-09 60mm 90mm, 5 holes**L6565-12** 60mm 120mm, 7 holes**L6565-15** 60mm 150mm, 9 holes**L6565-20** 60mm 200mm, 12 holes**L6566-09** 70mm 90mm, 5 holes**L6566-12** 70mm 120mm, 7 holes**L6566-15** 70mm 150mm, 9 holes**L6566-20** 70mm 200mm, 12 holes**L6567-09** 80mm 90mm, 5 holes**L6567-12** 80mm 120mm, 7 holes**L6567-15** 80mm 150mm, 9 holes**L6567-20** 80mm 200mm, 12 holes**Femoral**

130° blade length:

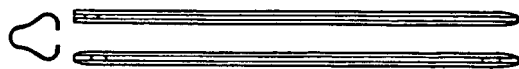
L6570-70 70mm**L6570-80** 80mm**L6570-85** 85mm**L6570-90** 90mm**L6570-95** 95mm**L6570-97** 100mm**L6570-98** 105mm**L6570-99** 110mm**Kuntscher**

femur, clover leaf, diameters available from 6mm to 17mm

L6575-22 lengths available from 220mm to 520mm, pointed one end**L6576-22** lengths available from 220mm to 520mm, pointed both ends**Kuntscher**

tibia-humerus, diameters available from 3mm to 8mm

L6577-12 Lengths available from 120mm to 280mm**Kuntscher**

tibia-humerus, V form, diameters available from 6mm to 13mm

L6578-18 lengths available from 180mm to 400mm

Osteotomes

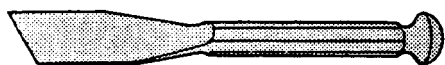
**Albee**

length 190mm
L6585-38 38mm
L6585-50 50mm

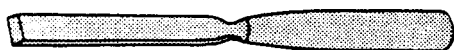
**Capener**

straight, tufnol handle, 250mm
L6590-10 10mm
L6590-12 12mm
L6590-16 15mm
L6590-21 20mm
L6590-26 25mm
L6590-31 30mm
L6590-35 set of 6

**Capener**

curved, tufnol handle, 250mm
L6595-10 10mm
L6595-12 12mm
L6595-16 15mm
L6595-21 20mm
L6595-26 25mm
L6595-31 30mm
L6595-35 set of 6

**Smith Petersen**

straight, 200mm
L6600-10 10mm
L6600-15 15mm
L6600-20 20mm
L6600-25 25mm
L6600-30 30mm

**Smith Petersen**

curved, 200mm
L6601-10 10mm
L6601-15 15mm
L6601-20 20mm
L6601-25 25mm
L6601-30 30mm

**Swedish**

straight, 200mm
L6605-10 10mm
L6605-15 15mm
L6605-20 20mm
L6605-25 25mm
L6605-30 30mm

Pin Cutter

**Double Action**

for cutting pins up to 5mm diameter
L6610-37 370mm

Pin Introducer

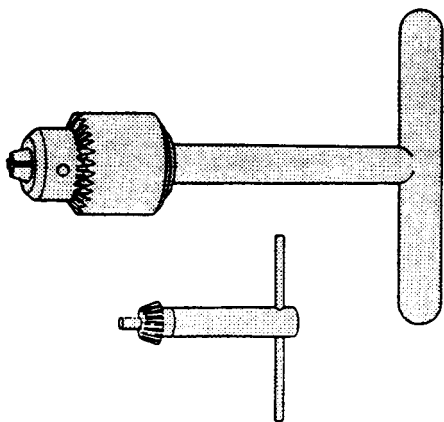
**Steinmann**

complete with Jacobs chuck and key
L6615-14 140mm

Plate Bender

**Lane**

L6618-02 2 required in use

Prosthesis Instruments

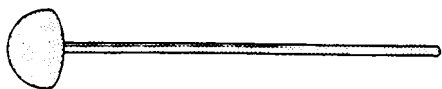
**Charnley Cup Pusher**

nylon head
L6620-29 295mm

**Moore Templet**

L6625-19 195mm

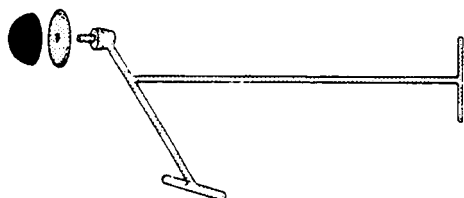
**Muller Cup Positioning**

handle, 32mm dome and 5 base plates
L6630-35 complete, 350mm

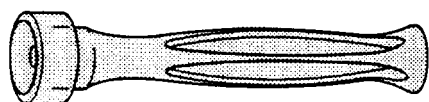
**Muller Punch**

L6635-01 detachable head

Punches

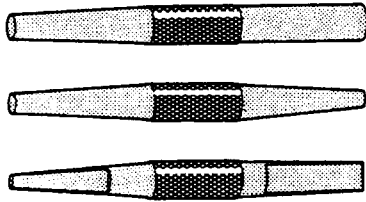
**McGoey**

double ended

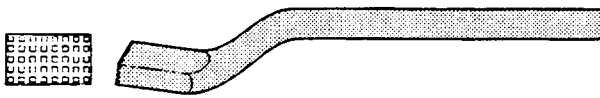
L6640-01 fig 1, 19mm 13mm**L6640-02** fig 2, 10mm 6mm**L6640-03** fig 3, 13mm 6mm**Smillie****L6645-01** angled**Smillie****L6645-01** straight

Raspatories

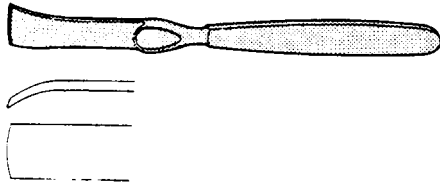
**Lambotte**

length 210mm

L6655-10 10mm**L6655-15** 15mm**L6655-20** 20mm**L6655-25** 25mm**St Thomas**

length 180mm

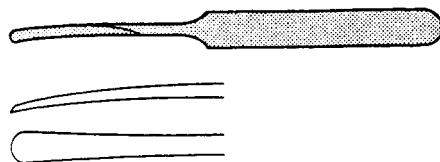
L6658-01 pointed**L6658-02** round**Williger Periosteal**

curved

L6660-13 130mm

Rasps

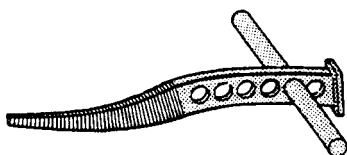
**Charnle Femoral****L6670-27** 270mm

Rasps

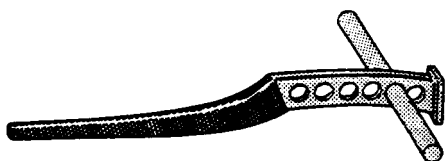

Moore
L6675-25 250mm

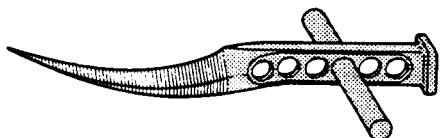

Muller Femoral
L6680-25 250mm

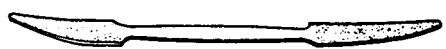

Putti
flat both ends
L6685-27 270mm

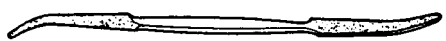

Putti
rounded one end
L6685-30 300mm

Retractors



Charnley
L6688-21 215mm, 50mm 6mm blade

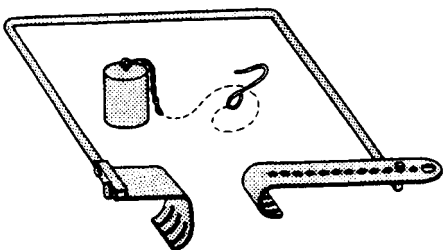

Charnley Initial Incision
L6690-30 305mm



Hohmann-Muller Spike
L6695-05 8mm
L6695-18 18mm
L6695-43 43mm
L6695-70 70mm

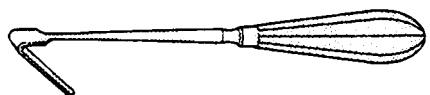

Jackson Burrows
broad angled
L6700-22 220mm

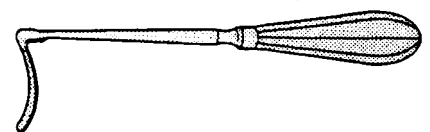

Jackson Burrows
narrow, curved
L6700-23 220mm

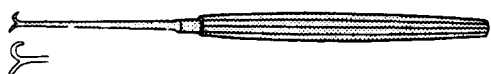

Rowe
L6704-01 boathook

Retractors

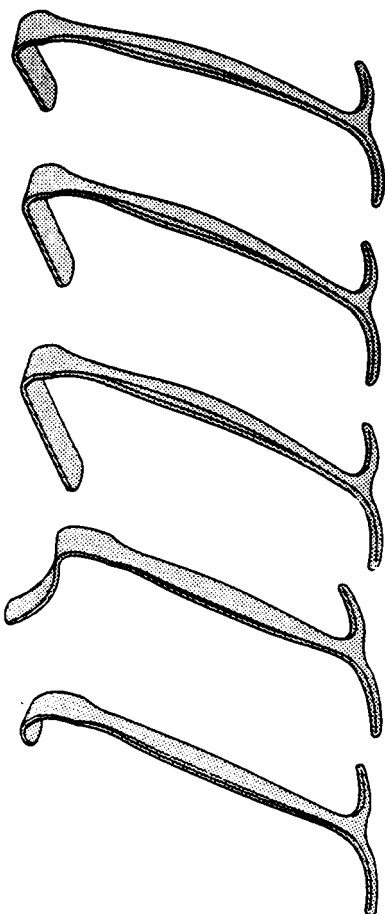

Smillie Hook
angled 145mm
L6708-32 32mm 19mm blade

Smillie Hook
angled, 145mm
L6708-41 41 mm 19mm blade

Smillie Hook
angled, 145mm
L6708-57 57mm 19mm blade

Smillie Hook
right angle, curved, 145mm
L6709-10 10mm blade

Smillie Hook
set of 2
L6710-14 145mm

Retractors, Self-Retaining

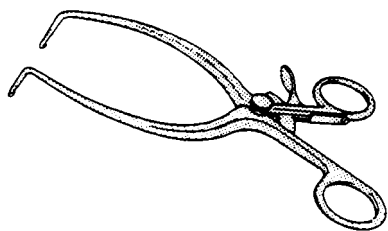

Jackson Burrows
L6715-17 175mm

Rongeurs

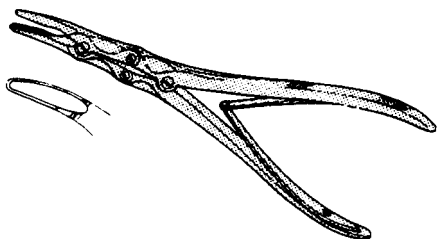

Jansen
curved, compound action
L6720-18 180mm

Rongeurs

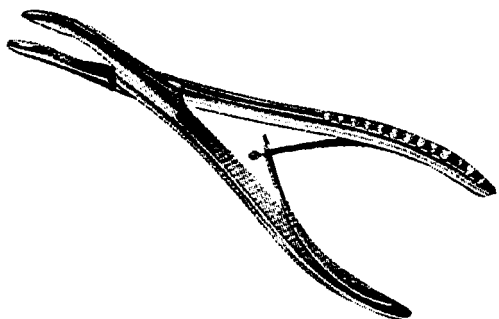
**Leskeli**

compound action

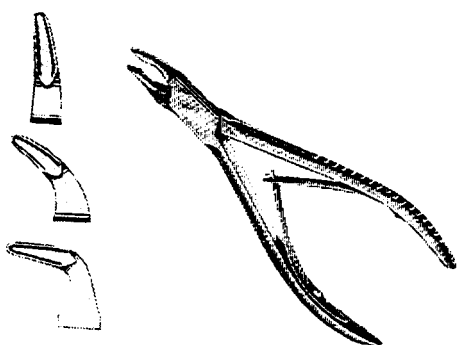
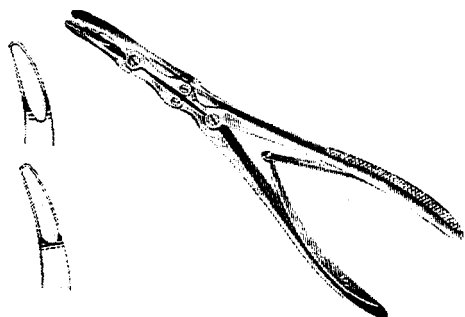
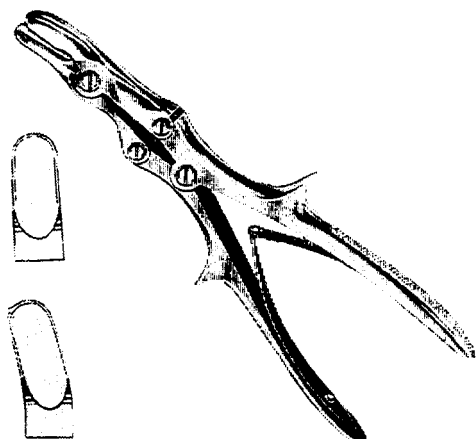
L6725-04 230mm, 4mm jaw**L6725-06** 230mm, 6mm jaw**L6725-08** 230mm, 8mm jaw**Blumenthal****L5575-01** 15.5cm**L5575-02** 15.5cm**L5575-03** 15.5cm**Beyer Zaufal-Jansen****Zaufal-Jansen****L5590-18** 18cm**Beyer****L5592-18** 18cm**Stille-Luer**

straight, 22cm

L5600-22

curved, 22cm

L5601-22

Rongeurs

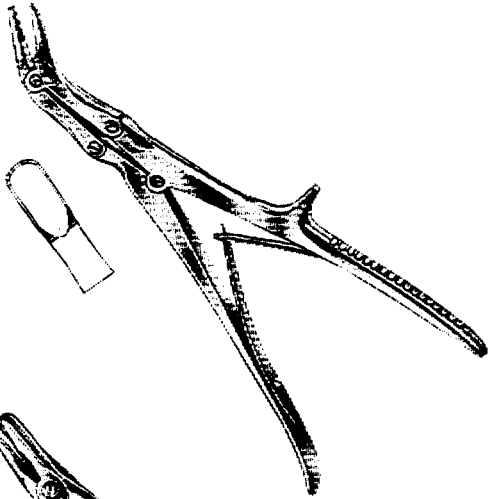
**Echlin**

23cm

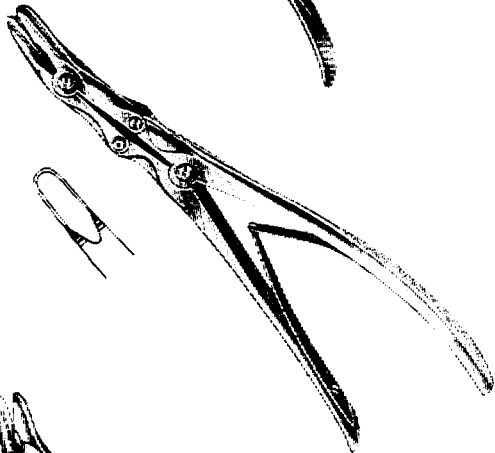
L5605-02 2mm**L5605-03** 3mm**L5605-04** 4mm**Leksell**

23cm

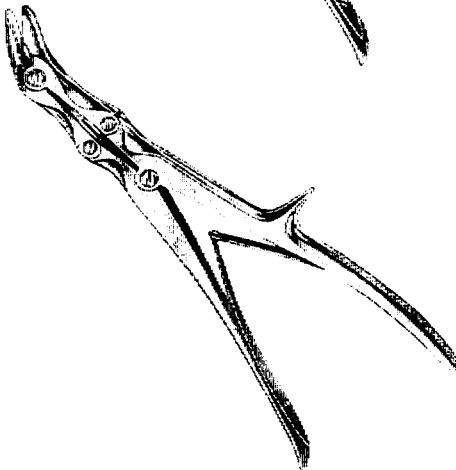
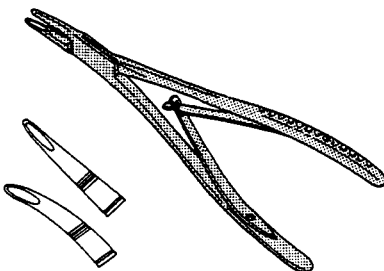
L5606-03 3mm**L5606-04** 4mm**L5606-06** 6mm**L5606-08** 8mm**Stille****L5608-23** 23cm**Olivecrona****L5565-20** 20cm**Lempert**

straight

L6730-19 190mm

curved

L6731-16 160mm**L6731-19** 190mm

Rongeurs

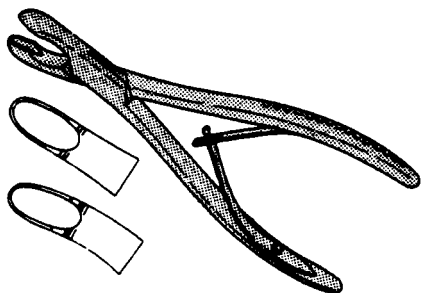
**Luer**

Straight, large

L6735-17 170mm

curved, large

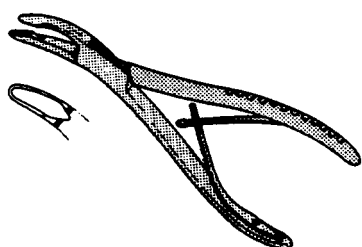
L6735-18 170mm**Luer**

curved, small

L6736-15 150mm

Rugines

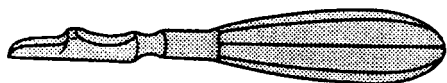
**Farabeuf**

straight, hollow handle

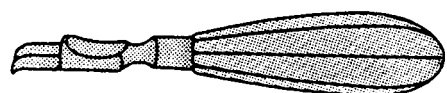
L6740-15 160mm**Farabeuf**

curved, hollow handle

L6740-16 160mm**Farabeuf**

straight, flat handle

L6741-15 150mm**Farabeuf**

curved, flat handle

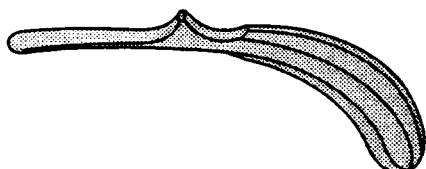
L6741-15 150mm**Jones**

pistol handle, fan shape

L6745-18 185mm

Screw Holding Forceps

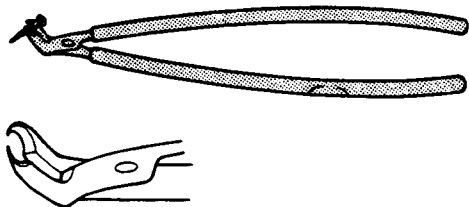

Lane
screw joint
L6755-23 235mm

Screwdrivers



Burns
self-retaining for single slot screws
L6760-25 250mm



Lane
for single slot screws
L6765-28 280mm



Phillips
for use with Phillips screws
L6770-28 285mm



Ratchet
for cruciform screws
L6775-25 250mm

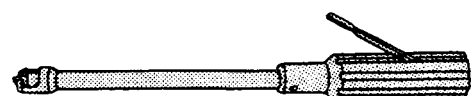

Williams
self-retaining for single slot screws
L6780-24 240mm

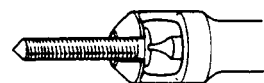

Splints

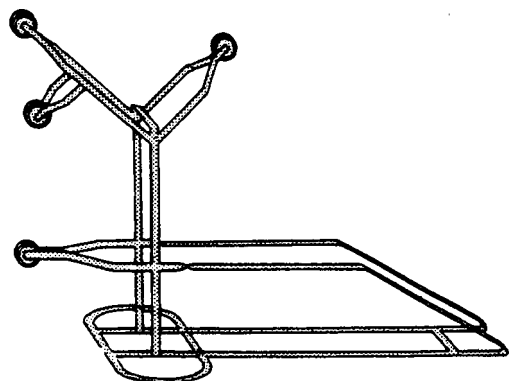

Bohler
for leg and thigh
L6790-01 4 pulley wheels

Splints

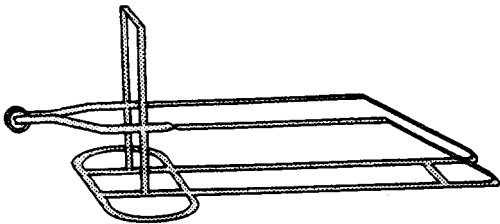
**Braun Extension Frame**

for leg

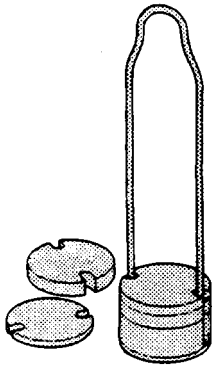
L6795-01 with pulley wheel attachment**Spain Weights**

platform, set of 7 weights, with cord

L6800-01 complete**Thomas**

aluminium painted, circumference length:

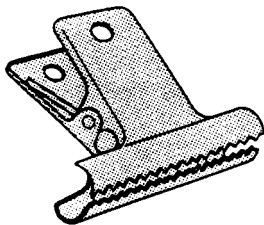
L6810-45 455mm 560mm**L6810-48** 485mm 660mm**L6810-53** 530mm 760mm**L6810-58** 585mm 865mm**L6810-61** 610mm 965mm**L6810-63** 635mm 1065mm

Spring Clip

Serrated**L6820-65** 65mm width of jaws

Staple Instruments

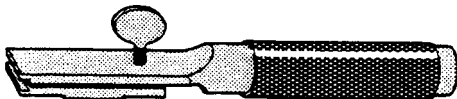
**Blount**

driver for large, small and wide staples

L6825-16 160mm**Blount**

remover

L6825-15 150mm**Blount**

set

L6825-16 165mm**Blount**

starter, 160mm

L6825-16 for 16mm staples**L6825-22** for 22mm staples

Staples

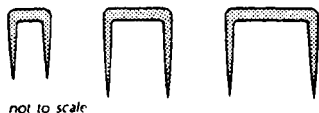

not to scale

Blount

5mm cross member, width length

L6830-10 10mm 17mm

L6830-16 16mm 21 mm

L6830-22 22mm 21 mm

Stirrups

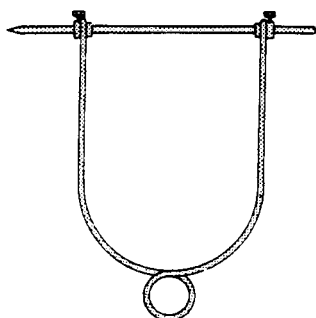

Bohler

rotating with

L6835-10

L6835-16

L6835-24

swivel fixation pieces, suitable for Steinmann pins

small, 100mm 90mm

medium, 165mm 115mm

large, 240mm 150mm

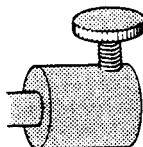

Bohler

pin mount, for 4mm and 6mm pins

L6836-22 22mm

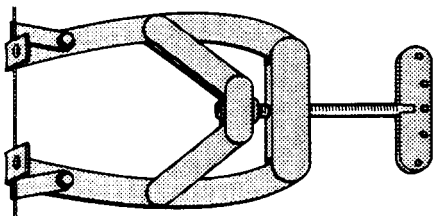

Gissane

adjustable with 2 hooks

L6840-12 small, 125mm

L6840-21 large, 215mm

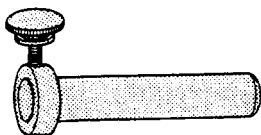

Steinmann Pin Caps

L6845-04 to shield end of 4mm and 6mm pins

Suture Forceps

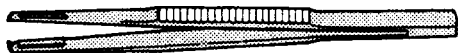

Charnley

slotted, 1/2 teeth

L6850-14 145mm

L6850-18 180mm



Suture Wire

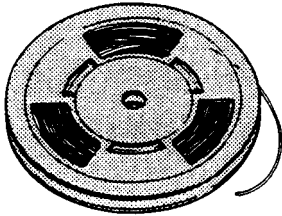

Monofilament

stainless steel, 25grm reel

- L6860-01 18swg
- L6860-02 20swg
- L6860-03 22swg
- L6860-04 24swg
- L6860-05 26swg
- L6860-06 28swg
- L6860-07 30swg
- L6860-08 33swg
- L6860-09 36swg
- L6860-10 38swg
- L6860-11 40swg

Tendon Instruments



Anderson Tunnelling Forceps

straight

- L6865-20 200mm
- L6865-24 240mm



Anderson Tunnelling Forceps

curved

- L6866-15 150mm
- L6866-24 240mm



Brand Fascia Lata Stripper

L6870-52 525mm

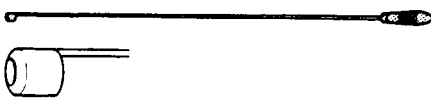

Brand Plantaris Stripper

L6875-52 525mm



fig 1



fig 2



fig 3

not to scale

Demel

- L6885-01 fig 1
- L6885-02 fig 2
- L6885-03 fig 3

Wire Guides

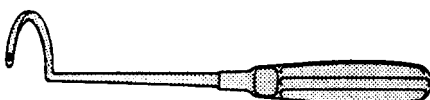

Parham

L6890-01 curved to side

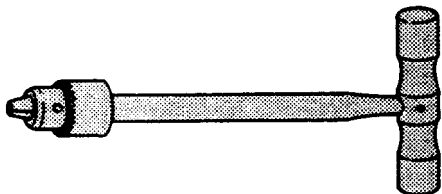

Wire Instruments

**Handle**

with chuck

L6895-10 100mm**Lute**

tightener

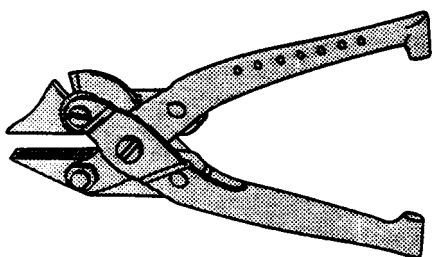
L6900-21 210mm**Pliers**

chrome plated with hammer end and side cutters

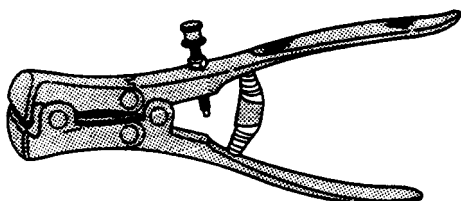
L6905-18 180mm**Pliers**

double action, large

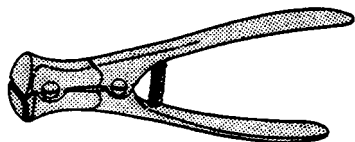
L6910-23 230mm**Pliers**

double action, small

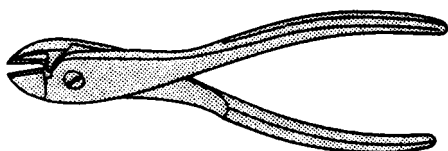
L6915-15 150mm**Pliers**

tungsten carbide

L6920-18 185mm

Wires

**Kirschner**

150mm length
L6930-08 diameters from 0.8mm to 1.5mm
 310mm length
L6931-01 diameters from 1 mm to 2.5mm

**Kirschner**

twist drill point, 160mm length
L6935-01 diameters from 1 mm to 3mm
 twist drill point, 310mm length
L6936-01 diameters from 1 mm to 3mm

**Knowles**

lengths from 65mm to 160mm
L6940-03 diameters 3.2mm and 4mm

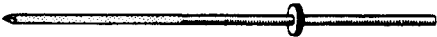
**Moore**

L6945-13 lengths from 130mm to 180mm

**Steinmann**

lengths from 80mm to 300mm
L6950-03 diameters from 3mm to 5mm

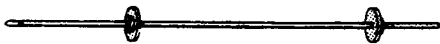
**Webb Bolt**

lengths from 180mm to 220mm
L6955-02 diameters from 2.5mm to 3mm

EARS, NOSE & THROAT



Adenotome

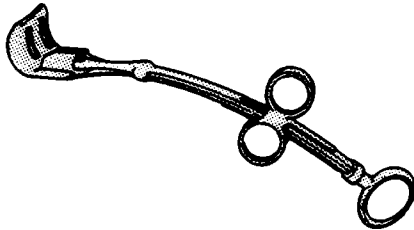

La Force

225mm
L7005-13 13mm cutting edge
L7005-15 15mm cutting edge
L7005-18 18mm cutting edge
 spare blade
L7005-23 13mm
L7005-26 15mm
L7005-28 18mm

Artery Forceps

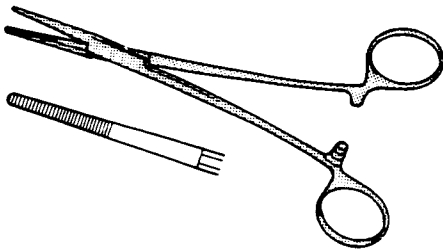

Birkett

straight 180mm
L7015-17

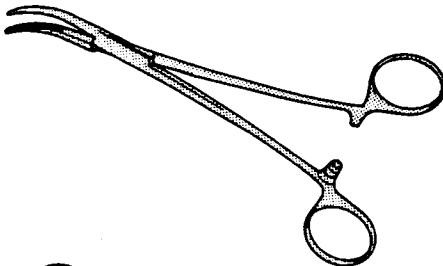

Birkett

curved to side
L7015-18 180mm
 curved on flat
L7015-19

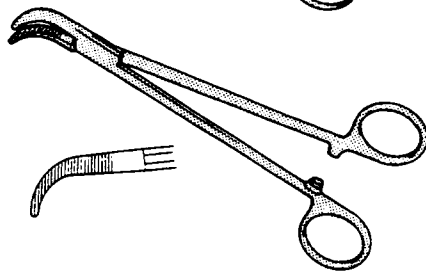

Sawtell

curved on flat 180mm
L7021-01

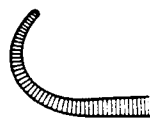
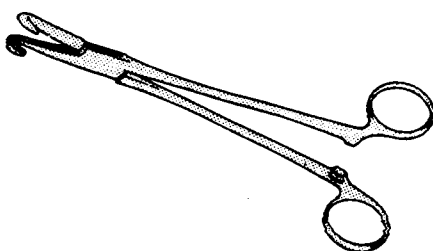

Negus

large curve
L7018-19 180mm



Nelus

small curve
L7018-18 180mm

Artery Forceps

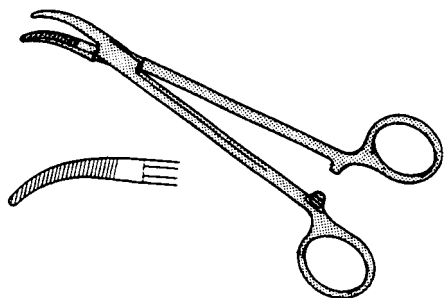

Schmidt
curved on flat 180mm
L7024-01

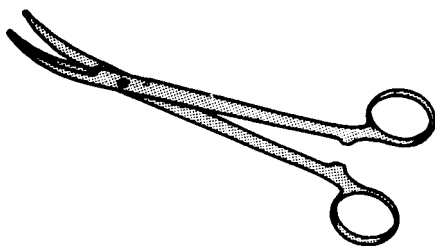

Scott
curved to side, screw joint
L7027-18 180mm

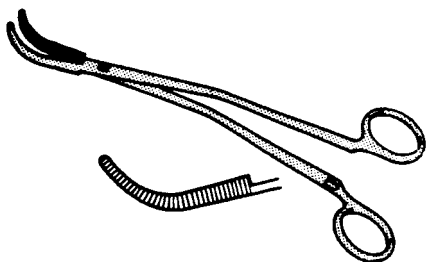

Wilson
curved on flat, angle shaft, screw joint
L7030-19 190mm

Aural Forceps

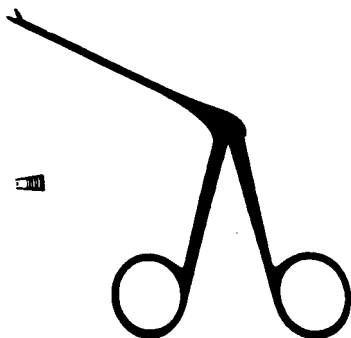

Beales
crocodile, black finish, extra fine with triangular jaws 70mm effective length
L7035-01

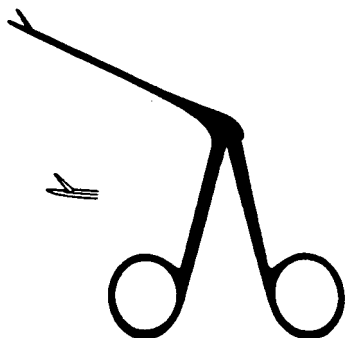

Cawthorne
crocodile, black finish, extra fine 70mm effective length
L7038-01

Aural Forceps

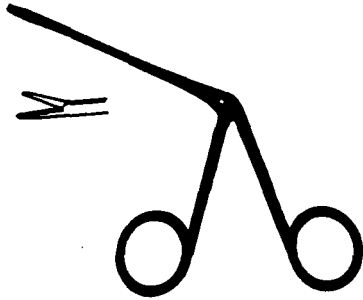
**Fuller**

crocodile, black finish, for introducing teflon pistons 65mm effective length
L7041-01

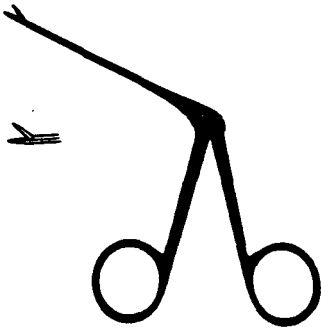
**Hartmann**

crocodile, black finish, extra fine 70mm
L7044-01

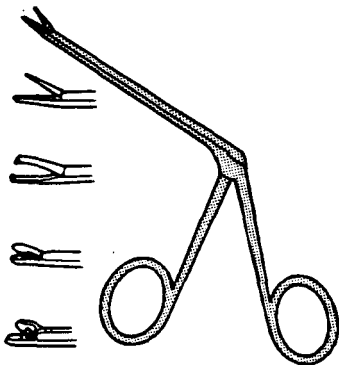
**Hartmann**

crocodile, serrated jaws 75mm effective length

L7044-02

crocodile, fine tenaculum jaws 75mm effective length

L7044-03

crocodile, round cutting jaws 75mm effective length

L7044-04

crocodile, Grunwald Punch Action jaws 75mm effective length

L7044-05

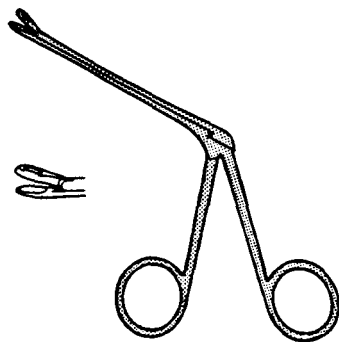
**Henckel**

scoop blades 75mm effective length

L7050-07

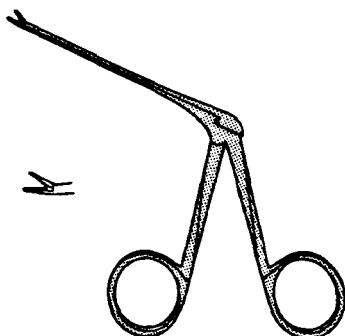
**Hough**

crocodile, satin finish 70mm effective length

L7056-01

Aural Forceps

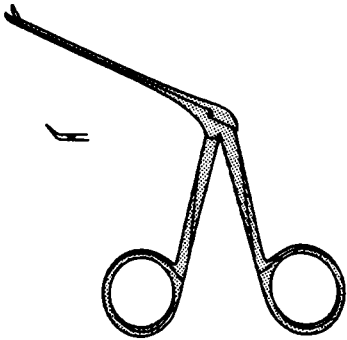
**Hough**

crocodile, satin finish, angled to right 70mm effective length
L7056-02

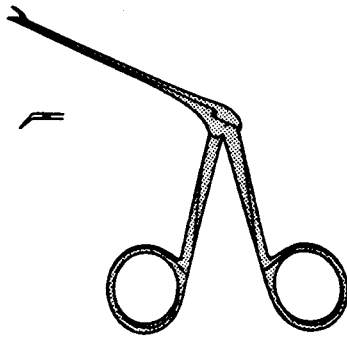
**Hough**

crocodile, satin finish, angled to left 70mm effective length
L7056-03

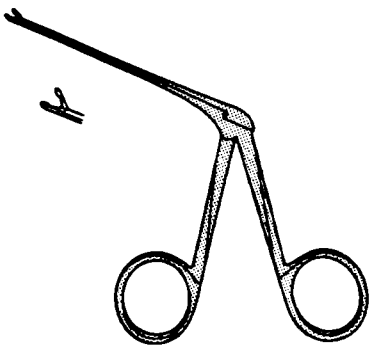
**Hough**

crocodile, satin finish, oval cup 70mm effective length
L7056-04

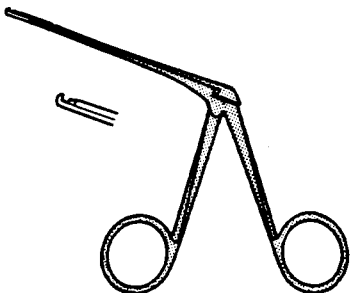
**House-Dieter Malleus**

fine, satin finish 75mm effective length
L7079-01

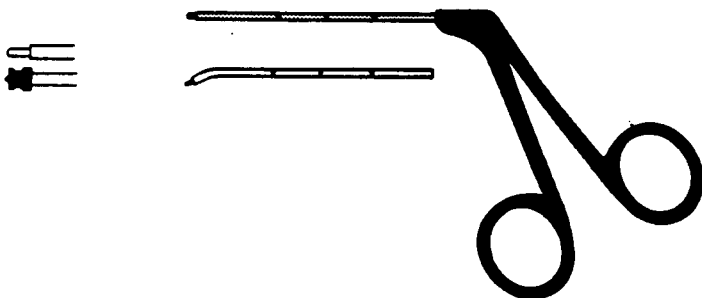
**Inserter, Grommet**

straight

L7060-09 small, 0.9mm grommet

L7060-10 medium, 1.0mm grommet

L7060-11 large, 1.15mm grommet

curved

L7061-09 small, 0.9mm grommet

L7061-10 medium, 1.0mm grommet

L7061-11 large, 1.15mm grommet

Aural Forceps

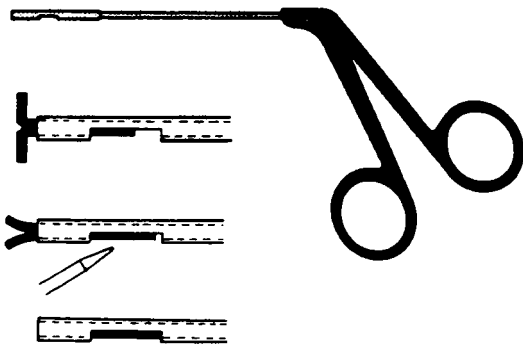
**Inserter T-Tube**

use blunt point to draw T-Tube completely into the instrument

L7062-01 adult

L7062-02 child

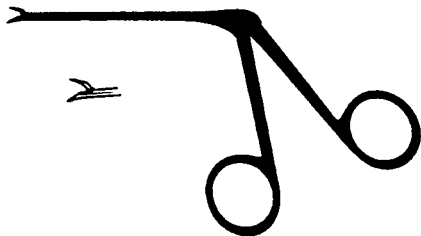
**McGee**

crocodile, black finish, wire closing 70mm effective length

L7064-01

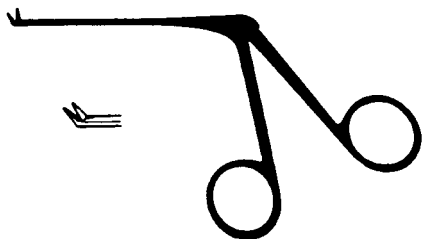
**Ormerod**

crocodile, black finish, extra fine, angled upwards 70mm effective length

L7065-01

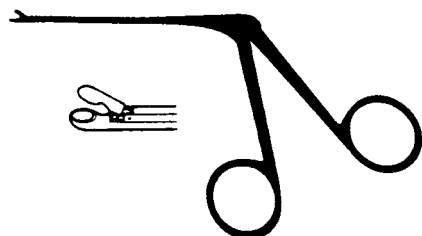
**Ormerod**

crocodile, black finish, fine circular cup 70mm effective length

L7065-02

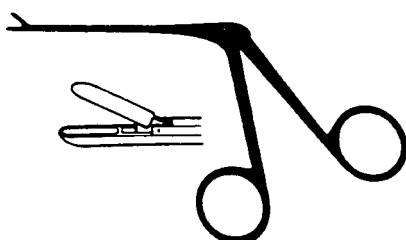
**Ormerod**

crocodile, black finish, fine elongated cup 70mm effective length

L7065-03

Aural Forceps

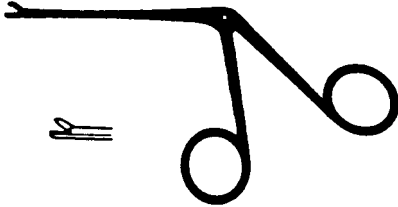
**Shah**

crocodile, black finish, for holding teflon pistons 70mm effective length
L7068-01

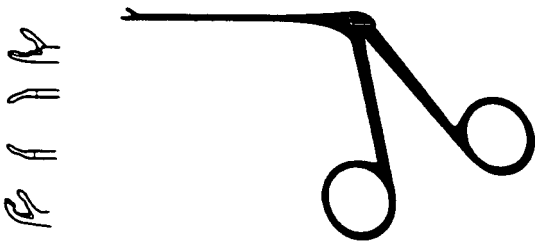
**Shea**

crocodile, black finish, oval cup jaw
L7071-70 straight, 70mm effective length
L7071-71 curved to the left, 70mm effective length
L7071-72 curved to the right, 70mm effective length
L7071-73 curved upward, 70mm effective length

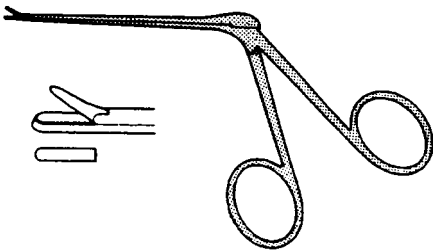
**Struycken**

crocodile, fenestrated under blade 75mm effective length
L7074-01

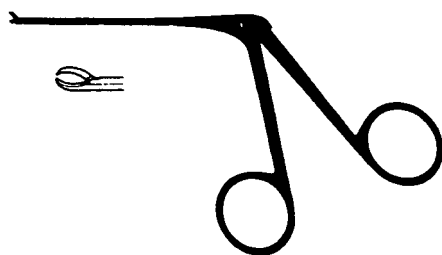
**Tabb Crura**

crocodile, black finish 75mm effective length
L7077-01

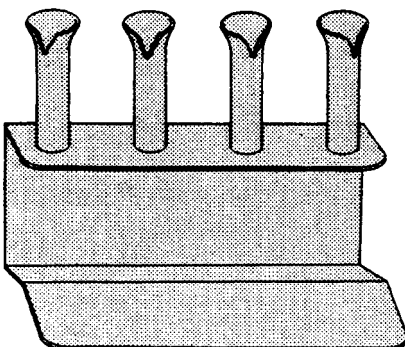
**Holder**

to hold 4 crocodile forceps 115mm
L7079-01

Aural Dressing Forceps

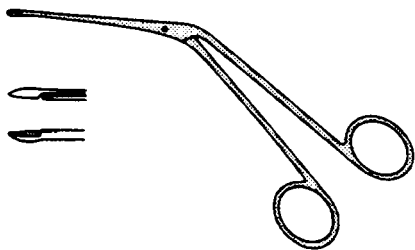
**Hartmann**

serrated, screw joint 140mm
L7080-05

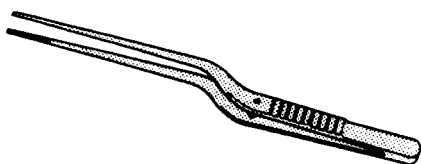
**Lucae**

serrated ends 150mm
L7082-01

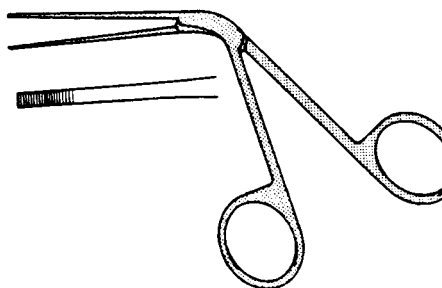
**Pritchard**

square serrated ends 145mm
L7084-01

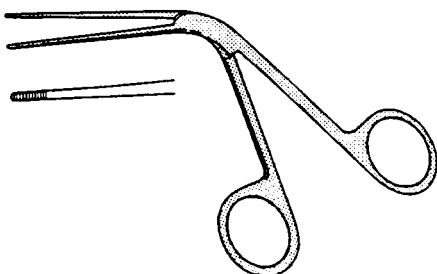
**Tilley**

serrated ends 145mm
L7086-01

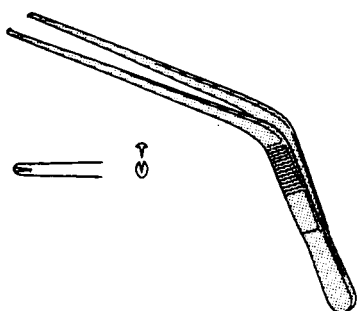
**Wilde**

1/2 teeth 135mm
L7088-01

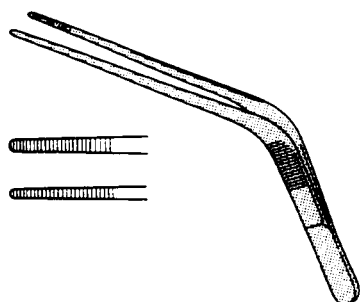
**Wilde**

serrated ends 135mm
L7088-02

Aural Instruments

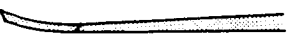
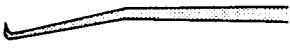
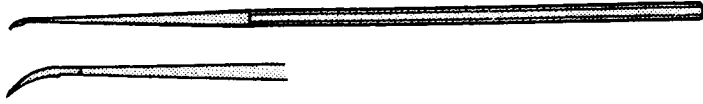
**Beales Platinectomy**

Knife, satin finish, 170mm
L7090-01 for cutting stapedius tendon

Applicator, left, satin finish, 170mm
L7090-02 for vein graft

Applicator, right, satin finish, 170mm
L7090-03 for vein graft

Curette, satin finish, 170mm
L7090-04 for removal of rim

Hook left, satin finish, 170mm
L7090-05 for removal of bone fragments

Hook, right, satin finish, 170mm
L7090-06 for removal of bone fragments

Hook, right, satin finish, 170mm
L7090-07 for removal of footplate

Hook, satin finish, 170mm
L7090-08 for removal of footplate

Osteotome, satin finish, 170mm
L7090-09 for elevation of the footplate

Perforator, satin finish, 170mm
L7090-10 for footplate

Raspatory, satin finish, 170mm
L7090-11 for removing mucous membrane
L7090-12 set of 11 instruments

Beales Tympanoplasty

Raspatory, satin finish slightly curved
L7093-01

Raspatory, satin finish small
L7093-02

Probe, satin finish fine, blunt
L7093-03

Aural Instruments

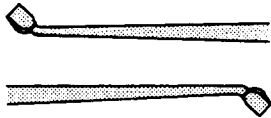

Rugine, satin finish double ended
L7093-04

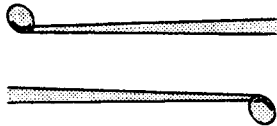

Rugine, satin finish double ended, sharp
L7093-05

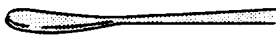

Spatula, satin finish for grafting
L7093-06
L7093-07 set of 6 instruments

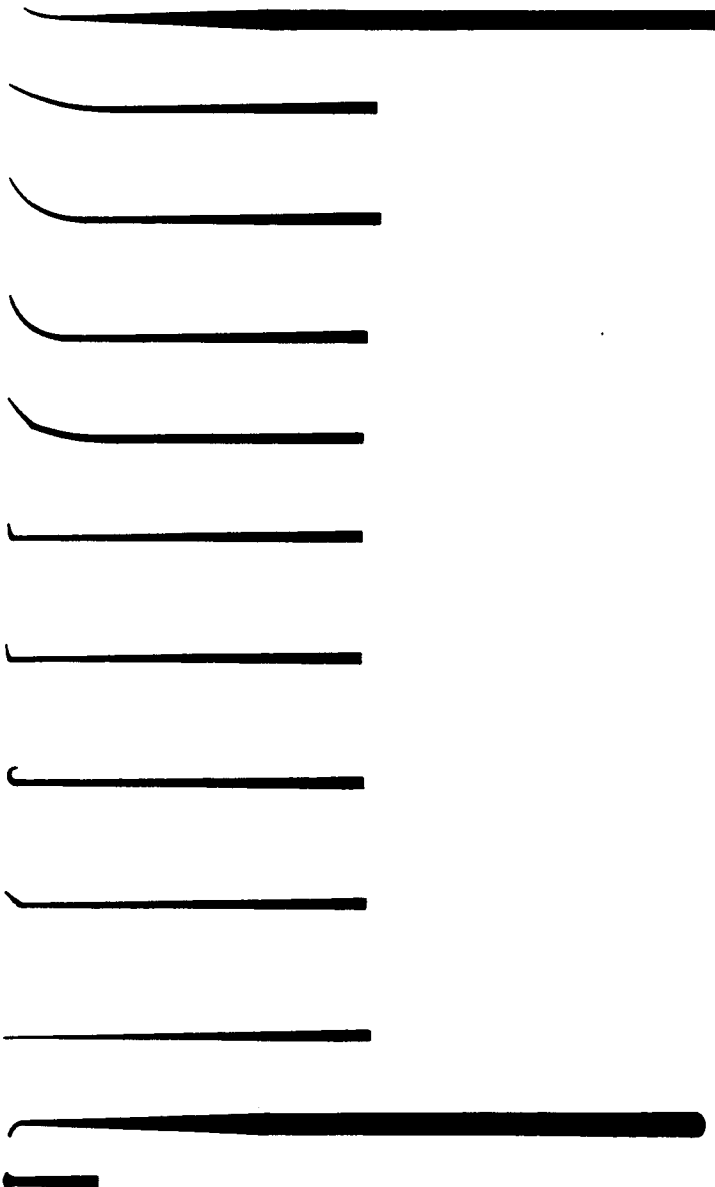
**Cawthorne**

Hook, black finish, 165mm
L7096-01 No. 1, slight curve

Hook, black finish, 165mm
L7096-02 No. 2, medium curve

Hook, black finish, 165mm
L7096-03 No. 3, full curve

Hook, black finish, 165mm
L7096-04 No. 4, double curve

RHook, black finish, 165mm
L7096-05 No. 5, 90° angle, 0.5mm

Hook, black finish, 165mm
L7096-06 No.6, 90° angle, 1 mm

Hook, black finish, 165mm
L7096-07 No. 7, retrograde

Hook, black finish, 165mm
L7096-08 No.8, 45° angle, 0.5mm

Hook, black finish, 165mm
L7096-08 No. 9, straight
L7096-10 set of 9

Cawthorne Knife
 first incision, black finish 165mm
L7099-01

Aural Instruments

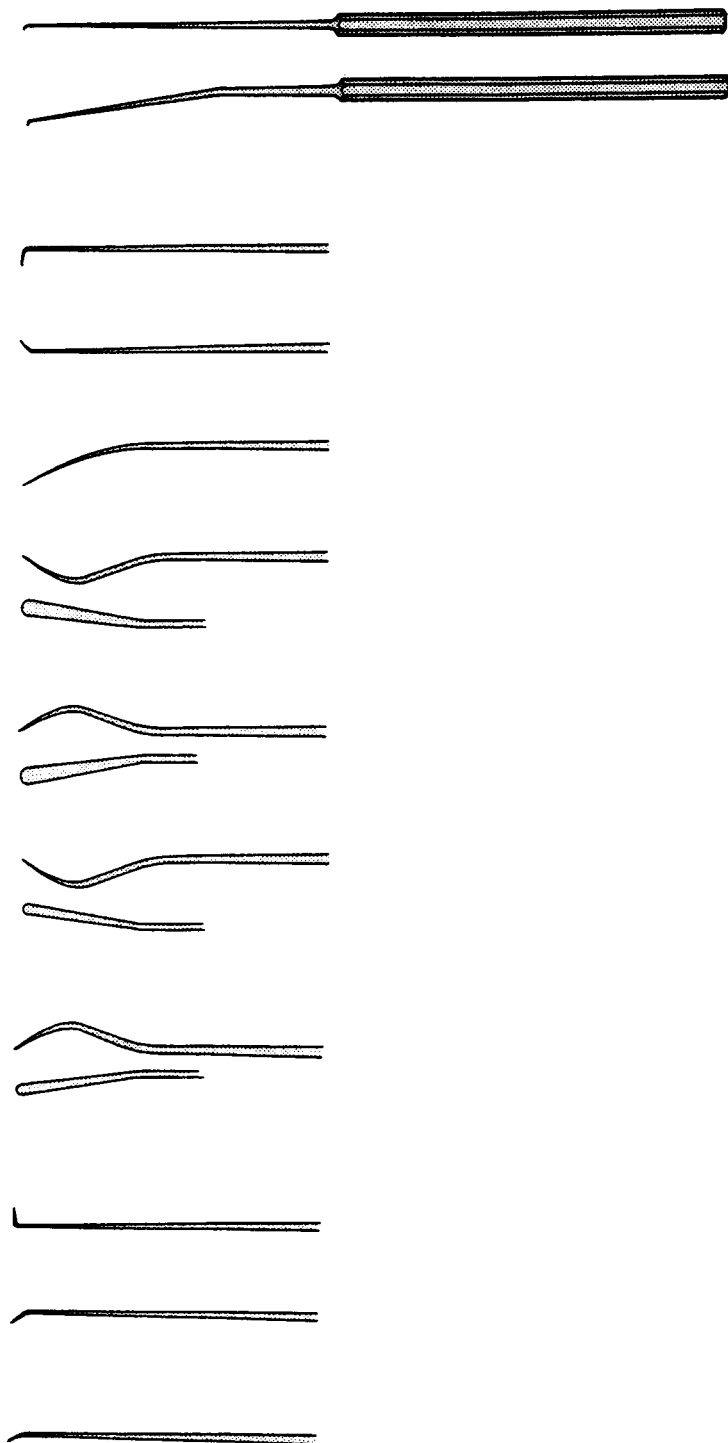
**Hough**

Hoe, 90°, 165mm

L7100-01 straight**L7101-01** angled

Hoe, 45°, 165mm

L7100-02 straight**L7101-02** angled

Hoe, curved 165mm

L7100-03 straight**L7101-03** angled

Whirlybird, large, right, 165mm

L7100-04 straight**L7101-04** angled

Whirlybird, large, left, 165mm

L7100-05 straight**L7101-05** angled

Whirlybird, small, right, 165mm

L7100-06 straight**L7101-06** angled

Whirlybird, small, left, 165mm

L7100-07 straight**L7101-07** angled

Stapedectomy Pick, 90°, 165mm

L7100-08 straight**L7101-08** angled

Stapedectomy Pick, 45°, 165mm

L7100-09 straight**L7101-09** angled

Stapedectomy Pick, 45°, 165mm

L7100-10 straight**L7101-10** angled**L7100-12** complete set of 10 straight instruments**L7101-12** complete set of 10 angled instruments

Aural Instruments

**Ironsides**

Needle, sharp black finish 165mm
L7102-01



Elevator, black finish 165mm
L7102-02



Hook, 45° up, black finish 165mm
L7102-03



Hook, 45° down, black finish 165mm
L7102-04



Hook, 90° up, black finish 165mm
L7102-05



Hook, 90° down, black finish 165mm
L7102-06



Knife, first incision, black finish 165mm
L7102-07

**Ironsides**

Knife, horizontal incision, black finish 165mm
L7102-08



Measuring Device, black finish 165mm
L7102-09
L7102-10 set of 9 instruments

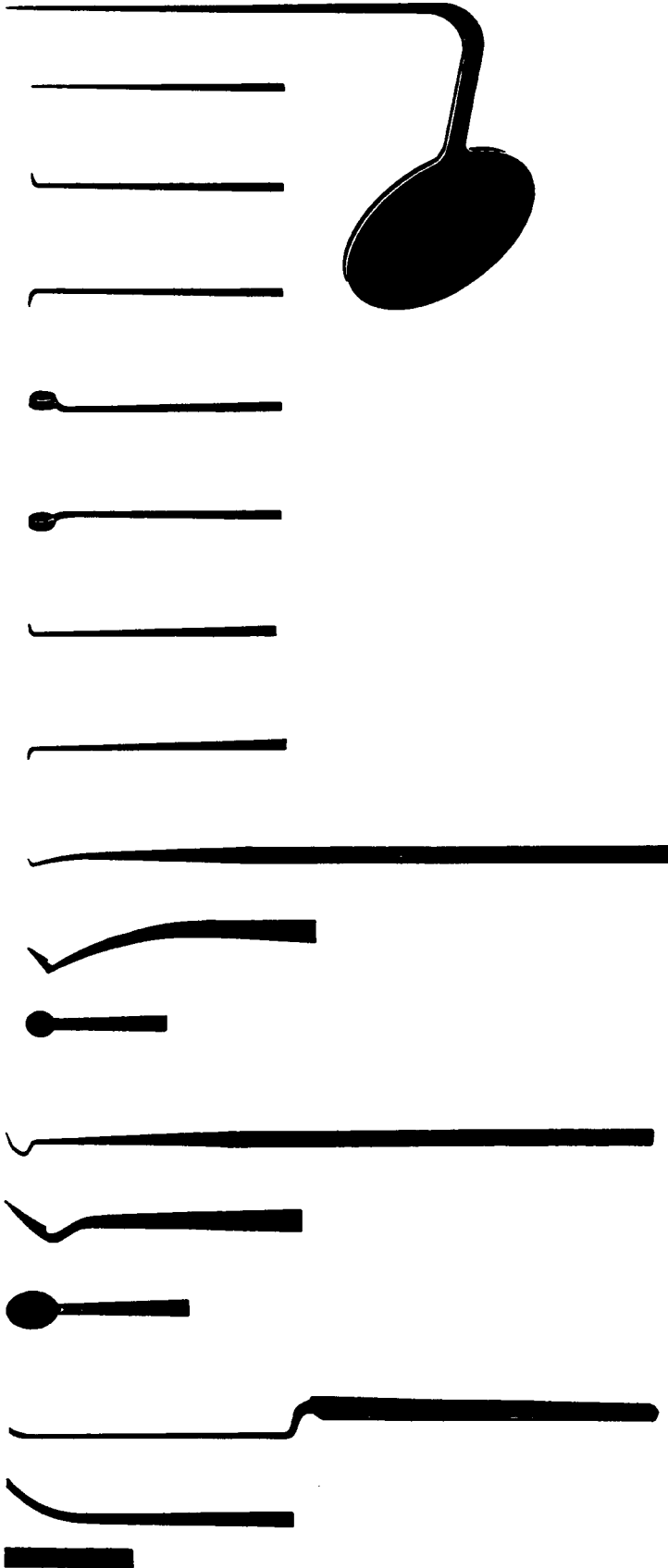

Aural Instruments

**Portmann and Claverie**

L7104-01 straight
needle, black finish, 70mm

L7104-02 upward, 0.7mm
Hook, black finish, 70mm

L7104-03 downward, 0.7mm
Hook, black finish, 70mm

L7104-04 upward
Curette, black finish, 70mm

L7104-05 downward
Curette, black finish, 70mm

L7104-06 upward 0.4mm
Micro-Hook, black finish, 70mm

L7104-07 downward 0.4mm
Micro-Hook, black finish, 70mm

L7104-10 set of 7 instruments

Rosen

Curette No. 5, black finish
L7105-16 160mm

Curette No. 6, black finish
L7105-17 160mm

Elevator No.2, bayonet shaped, broad, black finish
L7105-18 190mm

Aural Instruments

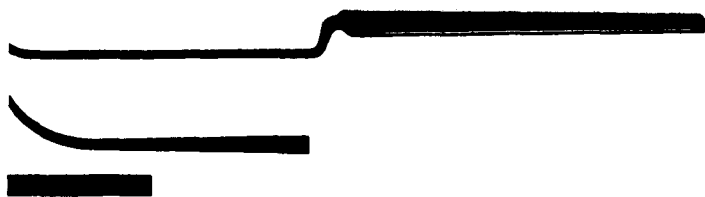

Elevator No. 3, bayonet shaped, narrow, black finish
L7105-19 190mm

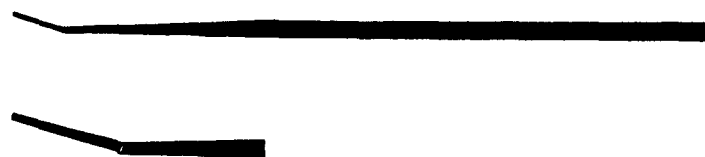

Elevator No. 4, black finish
L7105-20 160mm



Rosen
 Fenestrator, cross chequered handle, black finish
L7105-21 160mm

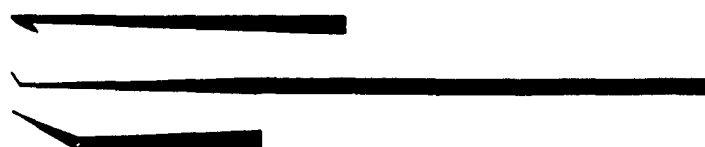

Knife, No. 1, black finish
L7105-22 160mm



Mobiliser No. 8, black finish
L7105-23 160mm



Mobiliser No. 9, black finish
L7105-24 160mm

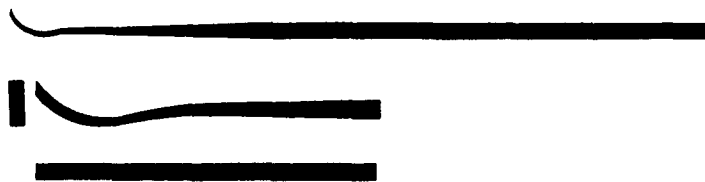

Probe, footplate, black finish
L7105-25 160mm

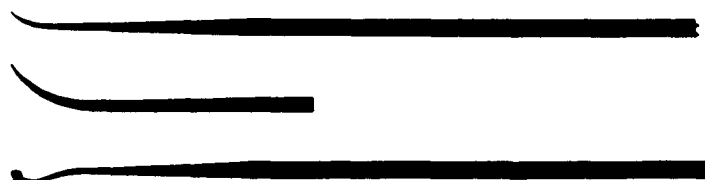

Scoop No. 11, oval, straight, size 000, black finish
L7105-26 160mm



Scoop No. 11, oval, straight, size 00, black finish
L7105-27 160mm



Scoop No. 11, oval, straight, size 0, black finish
L7105-28 160mm



Scoop, No. 11, oval, straight, size 1, black finish
L7105-29 160mm

Aural Instruments

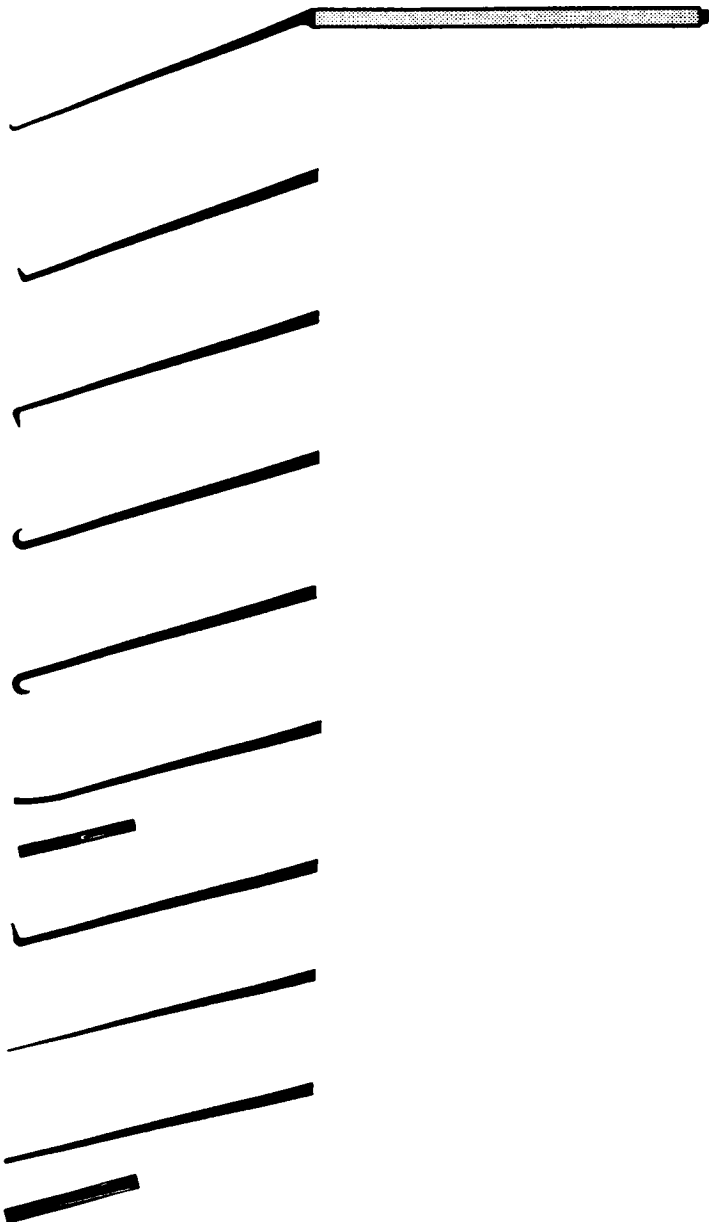
**Schuknecht**

Micro-Hook, black finish, 160mm
L7108-01 upward

Micro-Hook, black finish, 160mm
L7108-02 downward

Hook, black finish, 160mm
L7108-03 upward

Hook, black finish, 160mm
L7108-04 downward

Elevator, black finish, 160mm
L7108-05 oval window

Hook, black finish, 160mm
L7108-06 right angled upward

Pick, black finish, 160mm
L7108-07 straight

Spatula, black finish, 160mm
L7108-08 straight
L7108-10 set of 8 instruments

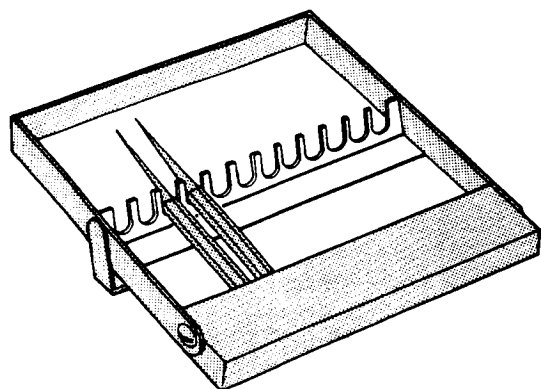
**Tray**

racked to autoclave and carry straight instruments

L7109-08 8 instrument

L7109-12 12 instrument

L7109-14 14 instrument

Aural Instruments

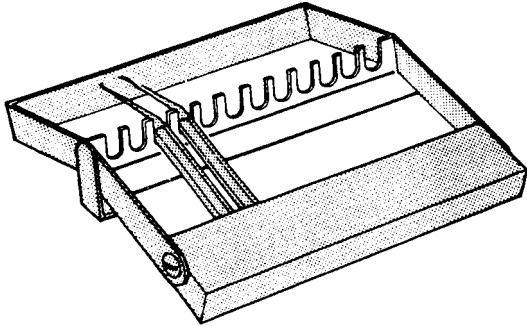
**Tray**

racked to autoclave and carry angled instruments

L7109-18 8 instrument

L7109-22 12 instrument

L7109-24 14 instrument

Aural Snare

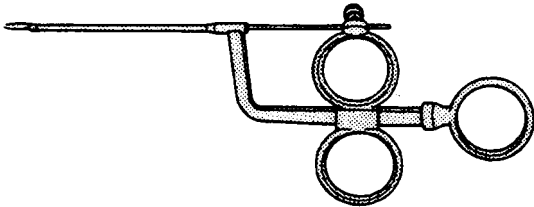
**Glegg**

self-forming 165mm

L7111-01

Aural Specula

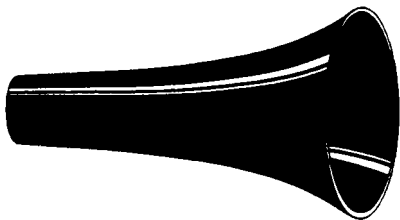
**Heath**

black finish

L7115-04 4mm

L7115-05 5mm

L7115-06 6mm

L7115-07 7mm

L7115-10 set of 4

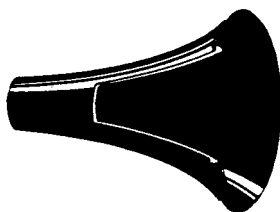
**Rosen**

slotted, round ends, black finish, 35mm

L7118-04 4mm diameter

L7118-05 5mm diameter

L7118-06 6mm diameter

L7118-07 7mm diameter

L7118-10 set of 4

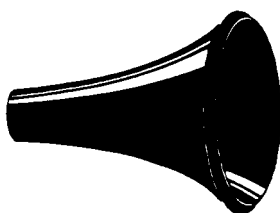
**Rosen**

unslotted, round ends, black finish, 35mm

L7121-03 3mm diameter

L7121-04 4mm diameter

L7121-05 5mm diameter

L7121-06 6mm diameter

L7121-07 7mm diameter

L7121-10 set of 5

Aural Specula

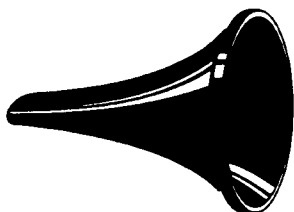
**Shea**

oblique ends, black finish, 35mm

L7124-33 3.3mm 4.1 mm

L7124-40 4.0mm 5.5mm

L7124-50 5.0mm 7.5mm

L7124-60 6.0mm 8.5mm

L7124-70 7.0mm 9.5mm

L7124-80 set of 5

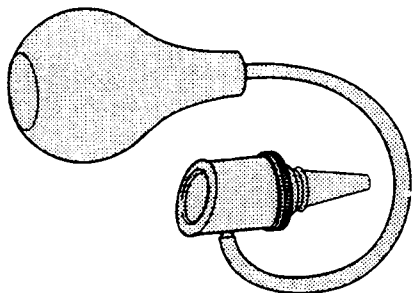
**Siegle (Peters)**

Otoscope with 3 ear specula, rubber tube and bulb

L7127-50 complete

L7127-65 spare speculum 6.5mm

L7127-70 spare speculum 7.0mm

L7127-80 spare speculum 8.0mm

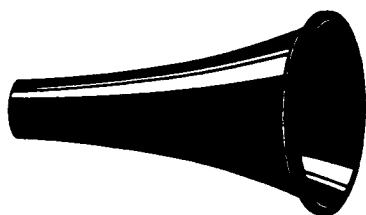
**Toynbee**

black finish, 40mm

L7130-04 5mm

L7130-06 6mm

L7130-07 7mm

L7130-10 set of 3

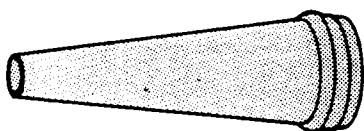
**Troltsch**

adult baby

L7133-04 4mm **L7135-01** 1.5mm

L7133-05 5mm **L7135-02** 2.5mm

L7133-06 6mm **L7135-03** 3.5mm

L7133-07 7mm **L7135-10** set of 3

L7133-10 set of 4

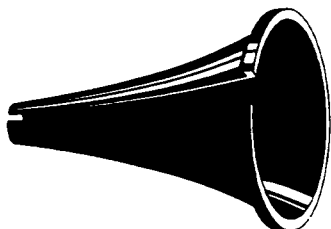
**Tumarkin**

tapered slot

L7138-00 size 0, 4.5mm

L7138-01 size 1, 6.5mm

L7138-02 size 2, 7.0mm

L7138-03 size 3, 7.5mm

L7138-04 size 4, 8.0mm

L7138-05 size 5, 8.5mm

L7138-06 size 6, 9.0mm

L7138-07 size 7, 11.0mm

L7138-10 set of 8

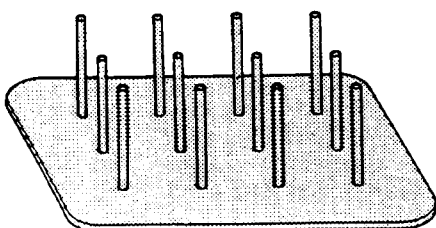
**Stand**

to support aural specula

L7140-12 for 12

L7140-18 for 18

L7140-24 for 24

Biopsy Forceps

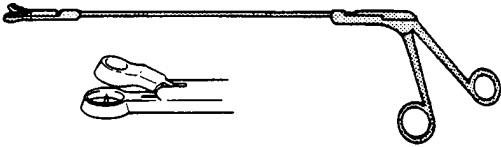
**Chevalier Jackson**

basket jaw with round end

L7145-28 280mm effective length

L7145-55 550mm effective length

**Chevalier Jackson**

basket lower jaw

L7147-35 350mm effective length

L7147-40 400mm effective length

L7147-45 450mm effective length

L7147-50 500mm effective length

L7147-55 550mm effective length

L7147-60 600mm effective length

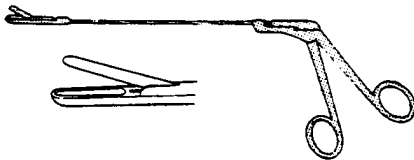
**Paterson**

L7150-20 200mm effective length

L7150-25 250mm effective length

L7150-30 300mm effective length

L7150-35 350mm effective length

L7150-40 400mm effective length

L7150-45 450mm effective length

L7150-50 500mm effective length

L7150-55 550mm effective length

L7150-60 600mm effective length

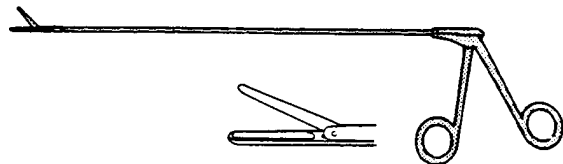
**Paterson**

extra fine

L7153-35 350mm effective length

L7153-45 450mm effective length

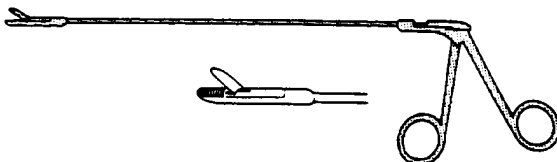
**Royal National Throat Nose and Ear Hospital**

extra fine

L7154-35 350mm effective length

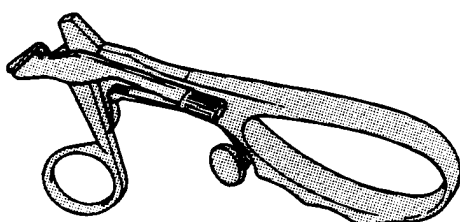
**Universal Handle**

interchangeable

L7155-01 Bruenings

Biopsy Forceps

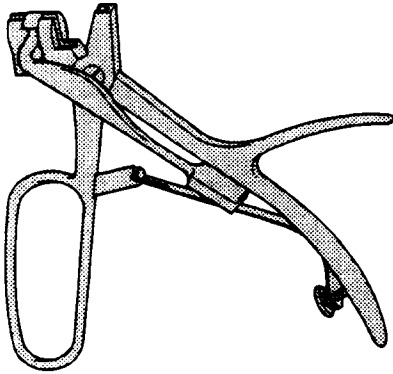
**Universal Handle**

interchangeable
L7155-02 Huber

**Universal Handle**

extension tube
L7156-20 200mm
L7156-30 300mm
L7156-40 400mm
L7156-50 500mm
L7156-60 600mm

**Universal Tip**

L7157-01 Baracani
L7157-02 Bruenings angled cup

**Universal Tip**

L7157-03 Bruenmgs, oval
L7157-04 Bruenings, straight cup, 2mm
L7157-05 Bruenings, straight cup, 3mm

**Universal Tip**

L7157-06 Cordes, punch end, circular

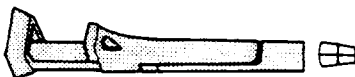

L7157-07 Cordes, punch end, rectangular



L7157-08 Flateau



L7157-09 Frankel, oval

Biopsy Forceps



L7157-10 Frankel, serrated

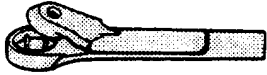

L7157-11 Krause, basket, circular

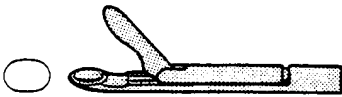
Universal Tip
 L7157-12 Krause, basket, rectangular

L7157-13 Lange

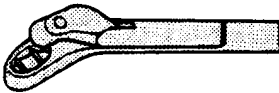

L7157-14 Scheinmann, basket



L7157-15 Scheinmann, oval



L7157-16 Schumacher



L7157-17 Seiffert

Bipod

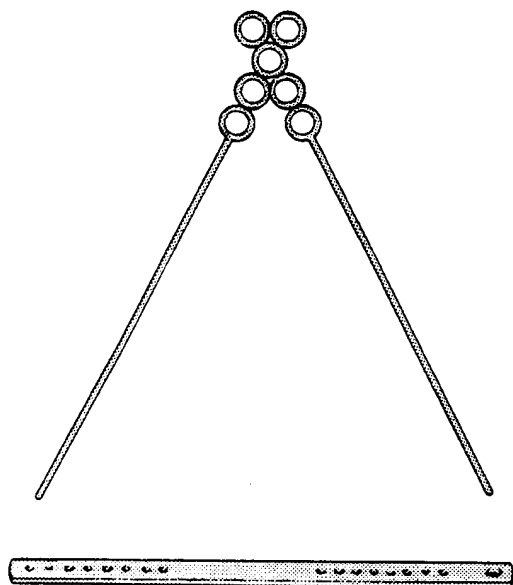
Draffin
 480mm
 L7160-01

Magauran Plate
 to hold bipod 405mm
 L7163-01

Bronchoscopes and Oesophagoscopes



Aspirating Tube

for use with Oseophagoscopes

L7166-20	2mm	350mm effective length
L7166-30	3mm	250mm effective length
L7166-31	3mm	300mm effective length
L7166-32	3mm	350mm effective length
L7166-33	3mm	450mm effective length
L7166-34	3mm	500mm effective length
L7166-35	3mm	600mm effective length
L7166-40	4mm	250mm effective length
L7166-41	4mm	300mm effective length
L7166-42	4mm	350mm effective length
L7166-43	4mm	450mm effective length
L7166-44	4mm	500mm effective length
L7166-45	4mm	600mm effective length
L7166-50	5mm	250mm effective length
L7166-51	5mm	300mm effective length
L7166-52	5mm	350mm effective length
L7166-53	5mm	450mm effective length
L7166-54	5mm	500mm effective length
L7166-55	5mm	600mm effective length
L7166-60	6mm	250mm effective length
L7166-61	6mm	300mm effective length
L7166-62	6mm	350mm effective length
L7166-63	6mm	450mm effective length
L7166-64	6mm	500mm effective length
L7166-65	6mm	600mm effective length

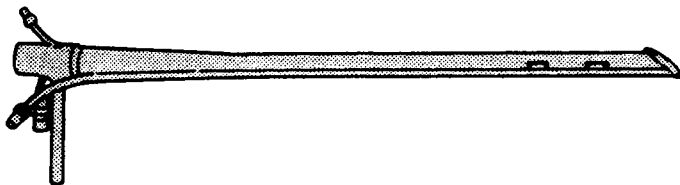

Negus Aspirating Bronchoscope

with fibre light carrier

L7170-30	300mm effective length, 6.5mm diameter, child
L7170-40	400mm effective length, 7.5mm diameter, adult

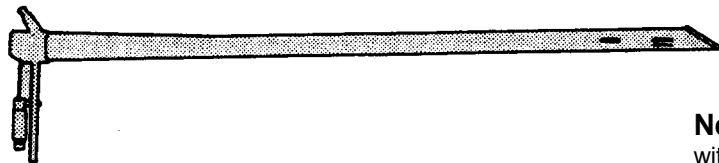

Negus Bronchoscope

with fibre light carrier

L7172-18	180mm effective length, 3.7mm diameter, short suckling
L7172-26	275mm effective length, 3.7mm diameter, suckling, small
L7172-27	275mm effective length, 4.1 mm diameter, suckling
L7172-28	275mm effective length, 5.4mm diameter, infant
L7172-30	300mm effective length, 7.0mm diameter, child
L7172-40	400mm effective length, 7.0mm diameter, adolescent, small
L7172-41	400mm effective length, 8.0mm diameter, adolescent
L7172-42	400mm effective length, 9.0mm diameter, adult, small
L7172-43	400mm effective length, 10.0mm diameter, adult

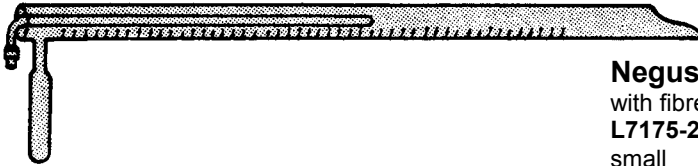
Bronchoscopes and
Oesophoscopes**Negus Oesophoscope**

with fibre light carrier

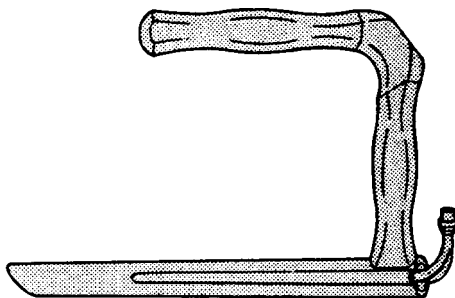
L7175-20 200mm effective length, 5.6mm 6.6mm lumen, infant, small**L7175-21** 200mm effective length, 7.6mm 8.6mm lumen, infant**L7175-25** 250mm effective length, 8.0mm 10.0mm lumen, child, short**L7175-35** 350mm effective length, 8.0mm 10.0mm lumen, child**L7175-36** 250mm effective length, 9.6mm 11.6mm lumen, adolescent, short**L7175-37** 350mm effective length, 9.6mm 11.6mm lumen, adolescent**L7175-38** 350mm effective length, 13.6mm 15.6mm lumen, adolescent**L7175-45** 450mm effective length, 15.6mm 17.6mm lumen, adult, long**L7175-53** 530mm effective length, 15.6mm 17.6mm lumen, adult, extra long**Negus Speculum**

with fibre light carrier

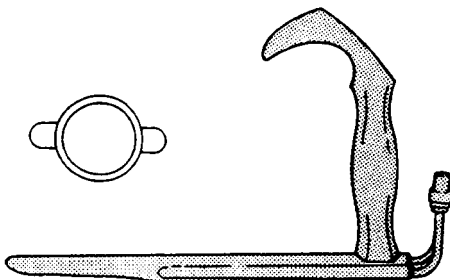
L7178-20 207mm effective length, 13mm 11 mm lumen, adult**Negus Speculum**

with fibre light carrier and long bevelled end

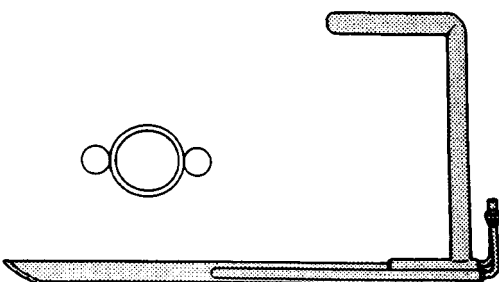
L7181-15 153mm effective length, 13mm lumen, child**L7181-22** 222mm effective length, 13mm lumen, adult**Negustracheoscope**

with twin fibre light carrier

L7184-15 157mm effective length, child**L7184-21** 218mm effective length, adult

Burs

**Tilley**

170mm

L7190-06 6mm diameter

L7190-07 7mm diameter

L7190-08 8mm diameter

Cannula

**Eicken-Killan**

3mm

L7195-01

**Hartmann**

L7198-20 2.0mm

L7198-25 2.5mm

L7198-30 3.0mm

**Killan**

L7201-15 1.5mm

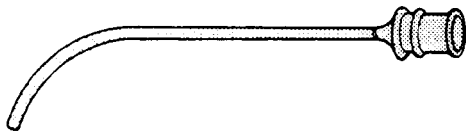
**Watson-Williams**

luer, malleable

L7204-04 4mm

Cartilage Shears

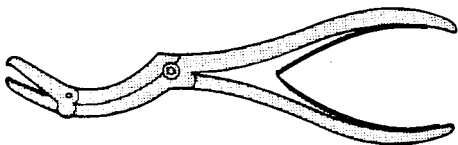
**Irwin Moore**

double action 190mm

L7210-19

Catheters

**Woakes Eustachian**

silver, luer, 140mm

L7215-07 7fg, 2.3mm

L7215-08 8fg, 2.7mm

L7215-09 9fg, 3.0mm

L7215-10 10fg, 3.3mm

L7215-11 11fg, 3.7mm

NETIC
AID

Cautery

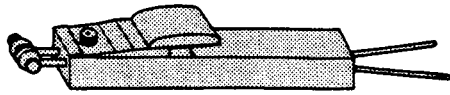

Handle

L7220-01 for use with burners

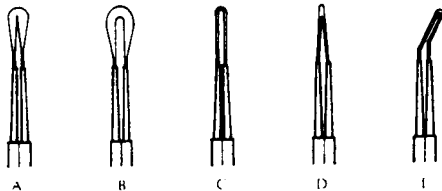

Burners

platinum tipped for use with handle

L7222-01 A

L7222-02 B

L7222-03 C

L7222-04 D

L7222-05 E

Cerumen Hooks



Cawthorne

145mm

L7230-14

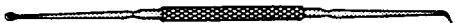

Formby

175mm

L7233-17

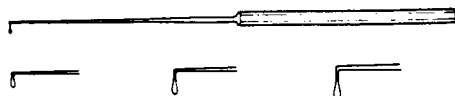

Lucae

140mm

L7236-01 small

L7236-02 medium

L7236-03 large

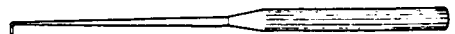

St Barts

blunt 175mm

L7239-01

Conchotomes

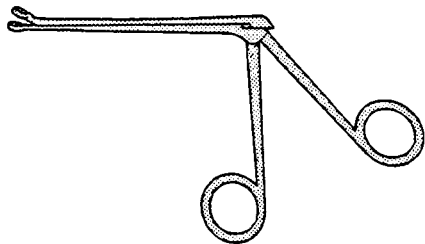

Hartmann

circular cutting, 100mm

L7245-05 5mm diameter

L7245-07 7mm diameter

L7245-09 9mm diameter

L7245-11 11 mm diameter

Curettes



Barnhill

length 215mm

L7253-10 10mm

L7253-14 14mm

L7253-16 16mm

L7253-18 18 mm

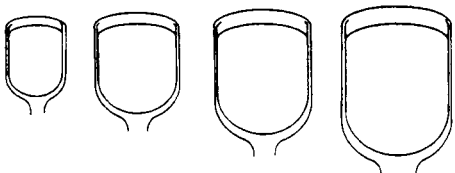

not to scale



Curettes

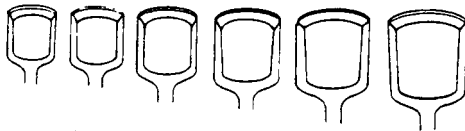

not to scale

Beckmann

length 215mm

- L7256-08 8mm
- L7256-10 10mm
- L7256-12 12mm
- L7256-14 14mm
- L7256-16 16mm
- L7256-18 18mm

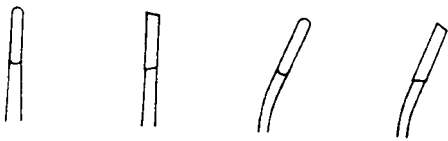

Buck

straight, blunt angled, blunt

- L7259-01 2.0mm
- L7259-02 2.5mm
- L7259-03 3.0mm
- L7259-04 3.5mm
- L7259-05 4.0mm
- L7259-21 2.0mm
- L7259-22 2.5mm
- L7259-23 3.0mm
- L7259-24 3.5mm
- L7259-25 4.0mm

straight, sharp angled, sharp

- L7259-11 2.0mm
- L7259-12 2.5mm
- L7259-13 3.0mm
- L7259-14 3.5mm
- L7259-15 4.0mm
- L7259-31 2.0mm
- L7259-32 2.5mm
- L7259-33 3.0mm
- L7259-34 3.5mm
- L7259-35 4.0mm



House

straight, double ended

- L7262-15 150mm
- L7262-16 150mm

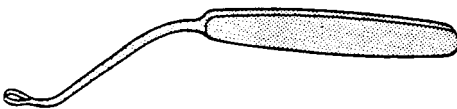

Mackie

length 195mm

- L7265-06 6mm diameter
- L7265-08 8mm diameter
- L7265-09 9mm diameter

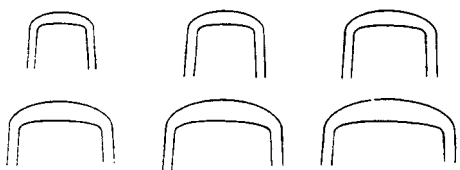

not to scale

St Clair Thomsom

length 235mm

- L7268-09 9mm
- L7268-11 10mm
- L7268-12 12mm
- L7268-14 14mm
- L7268-16 16mm
- L7268-18 18mm

not to scale

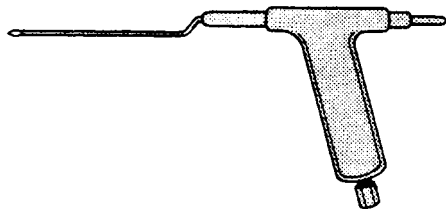

Diathermy

**Simpson Electrode**

spear pointed in pistol grip handle complete
L7315-01

Diathermy Forceps

**Remington Hobbs**

insulated, serrated 250mm

L7320-01

insulated, 1/2 teeth 250mm

L7320-02

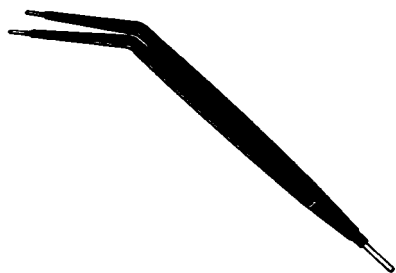
**Remington Hobbs**

insulated, serrated, angled 250mm

L7320-03

Dissectors

**Gwynne Evans**

double ended, 195mm

L7325-06 6mm wide

L7325-08 8mm wide

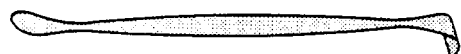
**Hurd**

double ended

L7328-19 195mm

**Mollison**

double ended

L7331-21 210mm

**Negus Aspirating**

205mm

L7334-20

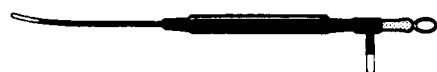
**Nelus Aspirating**

insuated 205mm

L7337-20

Dissectors



Popper
265mm
L7340-26



St Clair Thomson
blunt 160mm
L7343-16
sharp 160mm
L7343-17



Syme
one blunt, one semi sharp end 180mm
L7346-18

Elevators



Freer
double ended 200mm
L7350-20



Hill
double ended, curved to side 220mm
L7353-22

Foreign Body Forceps

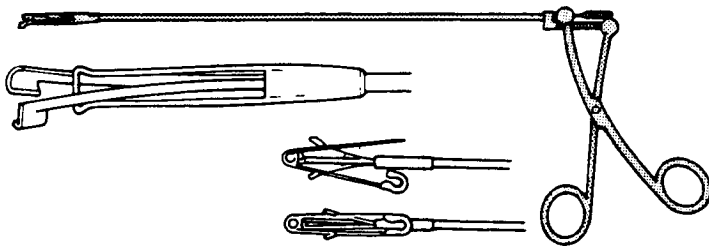

Clerf-Arrowsmith
for pin closure and removal
L7360-35 350mm effective length
L7360-40 400mm effective length
L7360-50 500mm effective length

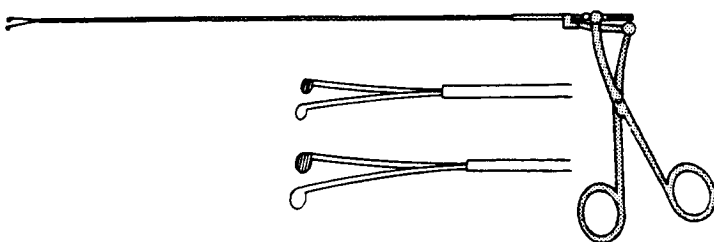

Howarth
extra fine
L7363-12 1.2mm diameter, 350mm effective length
L7363-25 2.5mm diameter, 350mm effective length

Gouges

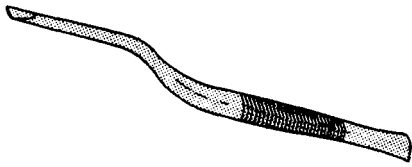
**Guy's**

shallow groove length 125mm
L7370-12

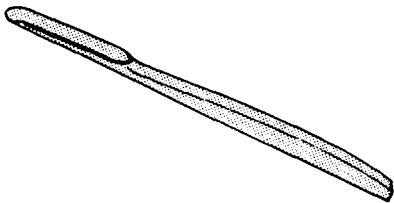
**Jenkins**

length 140mm

L7373-01 1mm

L7373-02 2mm

L7373-03 3mm

L7373-04 4mm

L7373-05 5mm

L7373-06 6mm

L7373-09 9mm

L7373-10 10mm

L7373-12 12mm

L7373-14 14mm

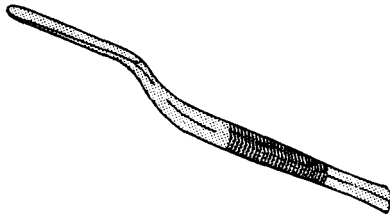
**Killian**

length 125mm

L7376-12

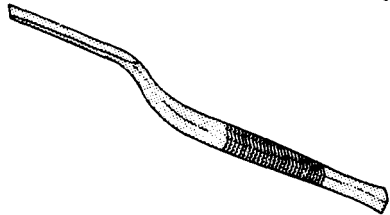
**Tilley**

length 125mm

L7379-12

Guillotine

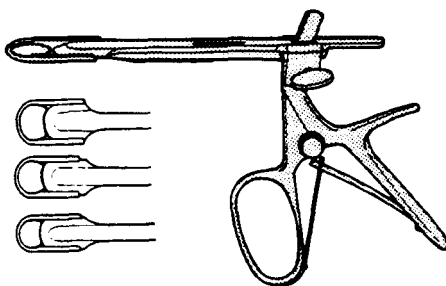
**Sluder-Ballenger**

complete with 3 tips
L7387-01

Guillotine Forceps

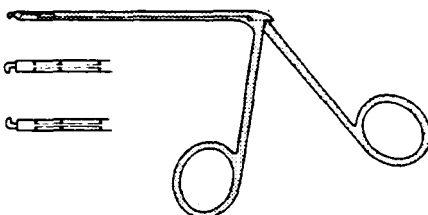
**Wishat**

125mm

L7390-01 left

L7390-10 right

Hypophysectomy Forceps

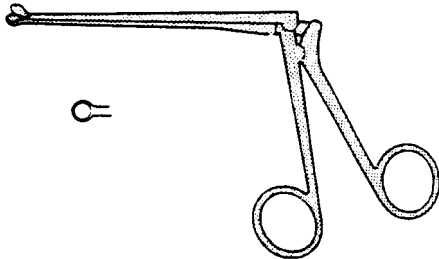

Angell James

reverse action, circular cup jaw, 125mm
L7395-35 3.5mm

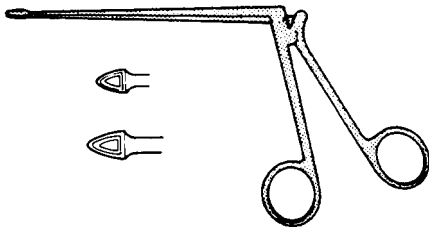

Angell James

reverse action, triangular jaws, 125mm
L7396-35 3.5mm
L7396-40 4.5mm

Insufflators

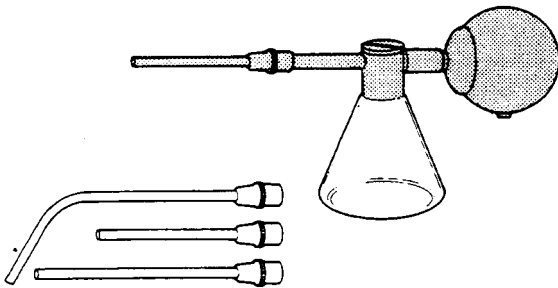

Kabierske

with bulb
L7400-01 complete
L7400-08 curved tip, 80mm
L7400-11 straight tip, 110mm
L7400-13 straight tip, 130mm

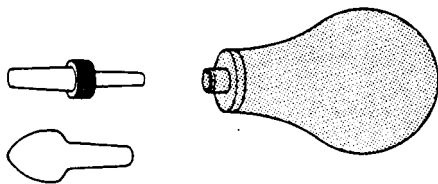

Politzer

with 3 nasal tips and connector
L7405-10 complete
L7405-15 nasal tip 15mm
L7405-17 nasal tip 17mm
L7405-22 nasal tip 22mm

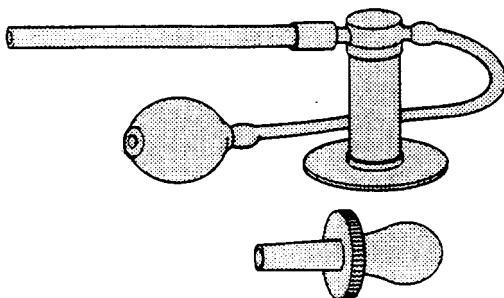

Stanford Cade

175mm
L7408-17

Tubing Mount

25mm
L7415-25

Knives

**Abraham Tonsil**

L7420-19 190mm

**Abraham Cleft Palate**

210mm

L7421-21

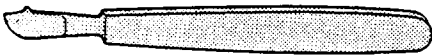
**Muck**

135mm

L7423-13

Knot Tier and Pusher

**Negus**

L7490-20 200mm

Laryngeal forceps

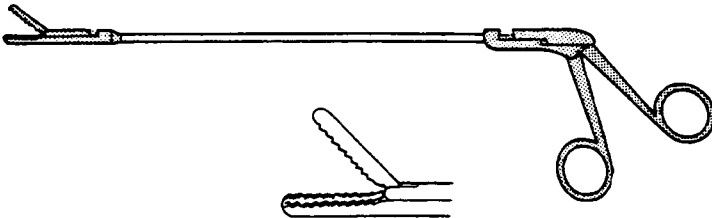
**Chevalier Jackson**

alligator jaw

L7435-30 300mm effective length

L7435-35 350mm effective length

L7435-40 400mm effective length

L7435-45 450mm effective length

L7435-55 550mm effective length

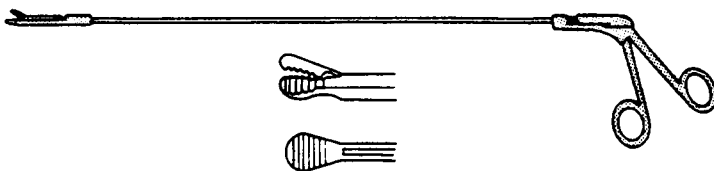
**Chevalier Jackson**

flat serrated jaws

L7437-30 300mm effective length

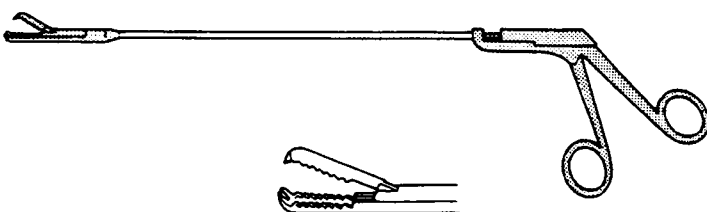
**Irwin Moore**

alligator jaw, tenaculum points

L7440-30 300mm effective length

L7440-35 350mm effective length

L7440-40 400mm effective length

L7440-55 550mm effective length

Laryngeal Instruments

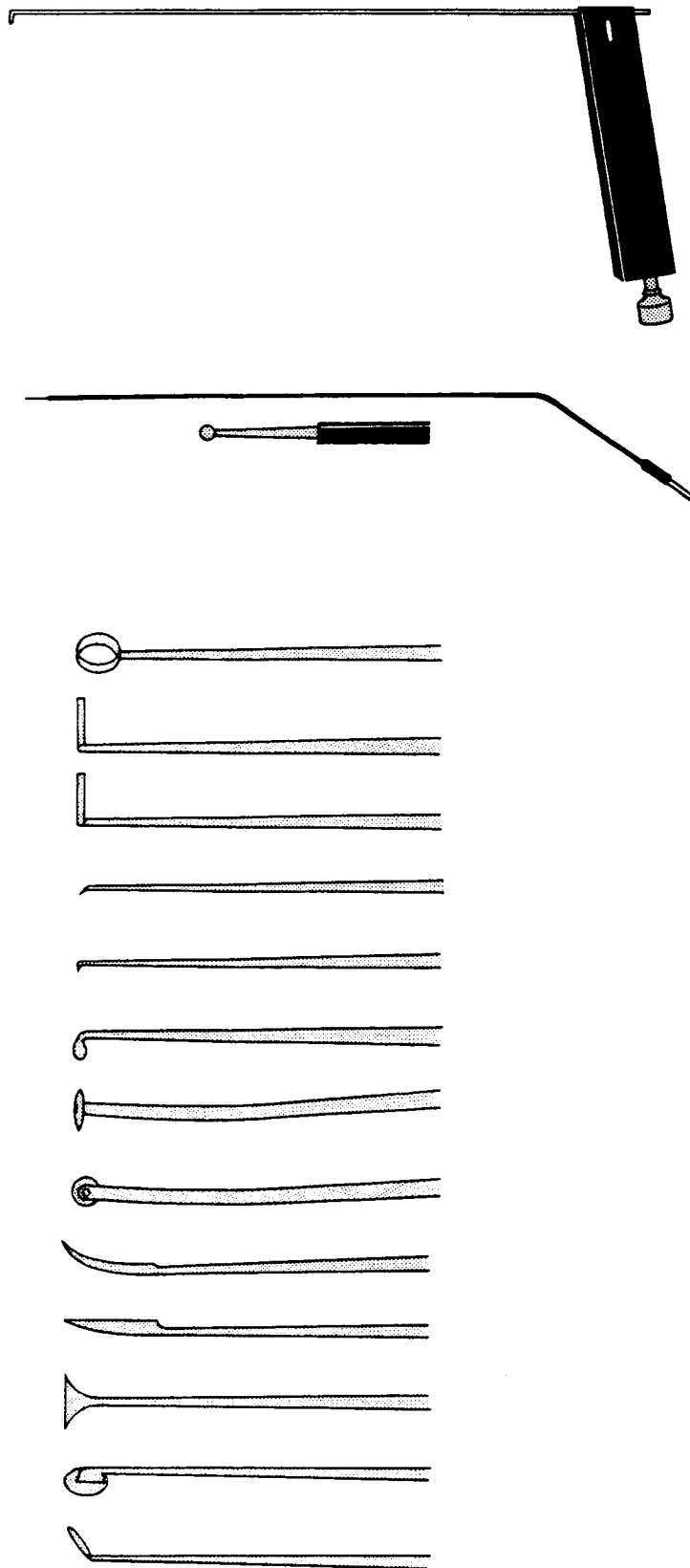
**Hermann**

for use with micro-laryngeal instruments, black finish
L7443-13 130mm

Micro, for use with Hermann Handle

Coagulation Probe, black finish, insulated
L7445-26 260mm

Curette, sharp
L7445-27 260mm

Cutting Guide, left
L7445-28 260mm

Cutting Guide, right
L7445-29 260mm

Hook, 45°, 1 mm
L7445-30 260mm

Hook, 90° 1 mm
L7445-31 260mm

Hook, blunt, angled to right
L7445-32 260mm

Knife, roller disc, horizontal
L7445-33 260mm

Knife, roller disc, vertical
L7445-34 260mm

Knife, sickle shape, curved
L7445-35 260mm

Knife, sickle shape, straight
L7445-36 260mm

Peeling Knife
L7445-37 260mm

Plester Separator, straight
L7445-38 260mm

Plester Separator, angled
L7445-39 260mm

Laryngeal Instruments

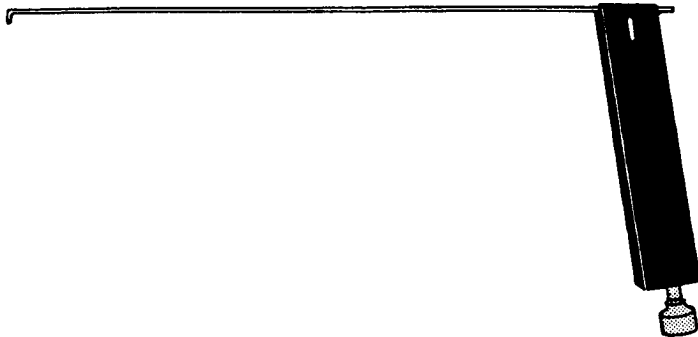
**Hermann Handle**

for use with micro-laryngeal instruments, black finish

**Micro**, for use with **Hermann Handle**

Pracy Suction Tube, black finish, insulated
L7445-45 250mm



Probe, blunt, 90°
L7445-46 260mm



Probe, blunt, straight
L7445-47 260mm

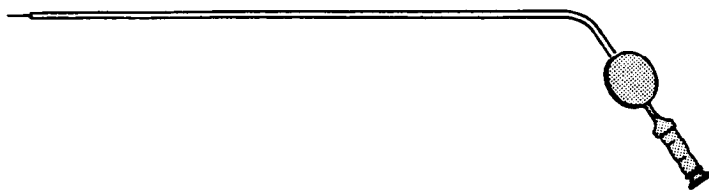

Suction Tube
L7445-48 260mm

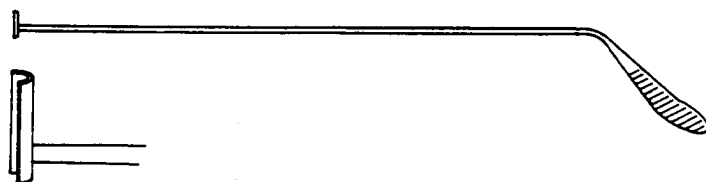

Vocal Cord Pusher
L7445-49 260mm

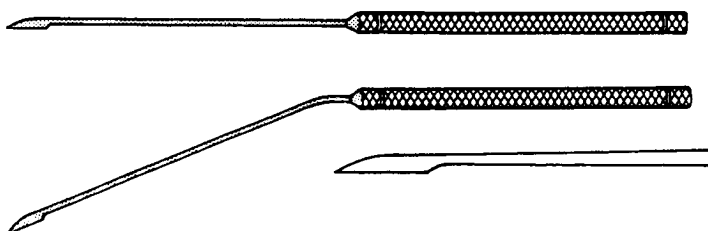
**Hand Held**

Knife, straight
L7450-01 straight
L7451-01 angled

Laryngeal Instruments

**Hand Held**

curette

L7450-02 straight**L7451-02** angled

Cutting Guide, right

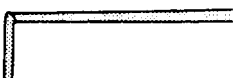
L7450-03 straight**L7451-03** angled

Cutting Guide, left

L7450-04 straight**L7451-04** angled

Hook, 45°

L7450-05 straight**L7451-05** angled

Hook, 90°

L7450-06 straight**L7450-065** angled

Knife, horizontal disc

L7450-07 straight**L7451-07** angled

Knife, vertical disc

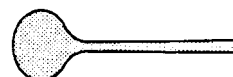
L7450-08 straight**L7451-08** angled

Hand Held

Knife, Peeling

L7450-09 straight**L7451-09** angled

Knife, curved

L7450-10 straight**L7451-10** angled

Probe, straight

L7450-11 straight**L7451-11** angled

Probe, 90°

L7450-12 straight**L7451-12** angled

Separator, Plester

L7450-13 straight**L7451-13** angled

Separator, straight

L7450-14 straight**L7451-14** angled**L7450-15** complete set of 14 straight instruments**L7451-15** complete set of 14 angled instruments

Laryngoscope Holder

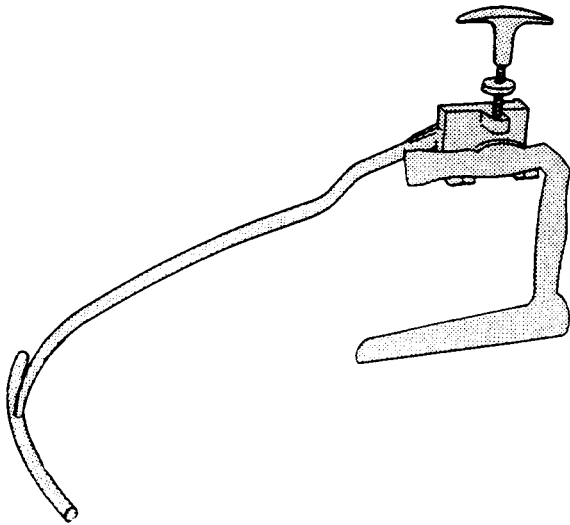
**Lewy**

chest support with adjustable clamps for laryngoscopes
L7485-01

Laryngoscopes

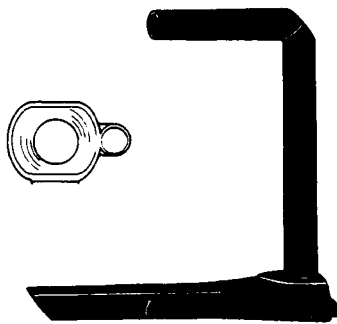
**Fraser**

for infants, black finish, single slide tube for fibre light carrier
18mm 14mm

proximal, 11 mm 9mm distal, 101 mm length

L7490-01

for children, black finish, single slide tube for fibre light carrier
20mm 14mm proximal, 13mm 12mm distal, 108mm length

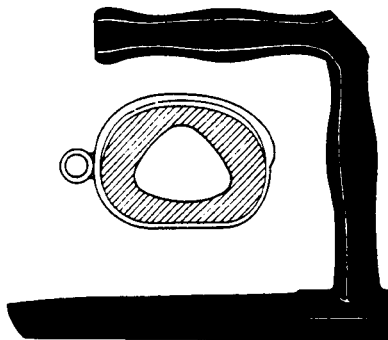
L7490-02

for small adults, black finish, single slide tube for fibre light carrier
20mm 15mm proximal, 14mm 13mm distal, 138mm length

L7490-03

for adults, black finish, single slide tube for fibre light carrier
28mm 20mm proximal, 16mm 15mm distal, 150mm length

L7490-04

for adults with difficult teeth, black finish, single slide tube for
fibre light carrier

25mm 11 mm proximal, 18mm 14mm distal, 151mm length

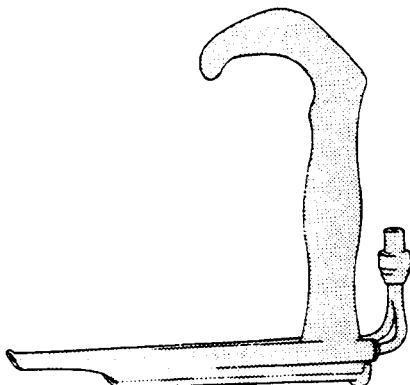
L7490-05**Negus**

infant, with twin fibre light carrier 10mm 0mm lumen, 82mm
effective length

L7493-01

child, with twin fibre light carrier 12mm 12mm lumen, 99mm effec-
tive length

L7493-02

Laryngoscopes

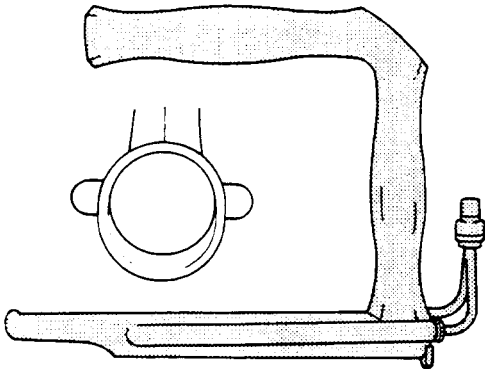
**News**

adult, with sliding panel and twin fibre light carrier 15mm 15mm lumen 135mm effective length
L7493-03

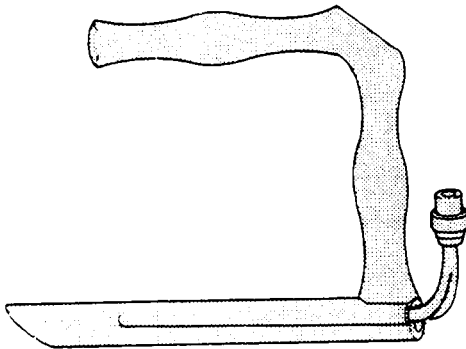
**Negus**

anterior commissure, with twin fibre light carrier 10.5mm 9mm lumen, 145mm effective length
L7493-04

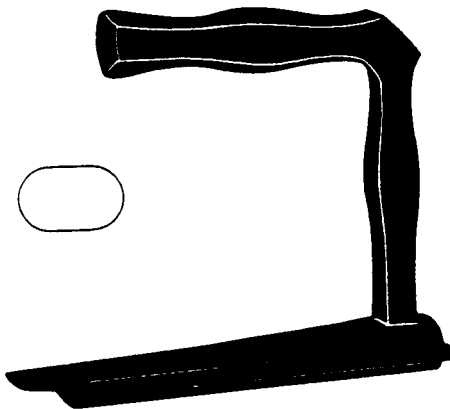
**Royal National Throat Nose and Ear Hospital**

anterior commissure, black finish, with single slide tube for fibre light carrier

L7496-21 21 mm 19mm proximal, 15mm 14mm distal, small 123mm length

L7496-22 22mm 20mm proximal 15mm 14mm distal, medium, 149mm length

L7496-28 28mm 16mm proximal, 18mm 15mm distal, large, 149mm length

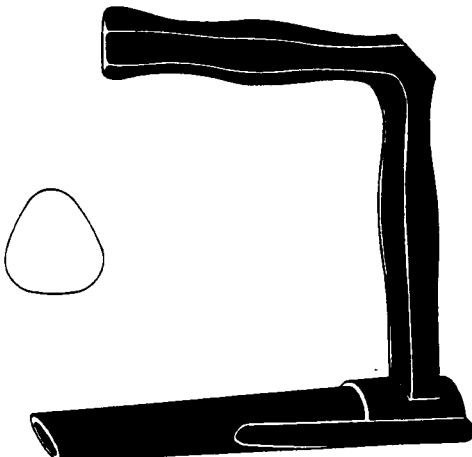
**Royal National Throat Nose and Ear Hospital**

black finish, with single slide tube for fibre light carrier

L7499-20 20mm 15mm proximal, 15mm 11mm distal, small, 120mm length

L7499-24 24mm 15mm proximal, 15.5mm 11mm distal, medium, 150mm length

L7499-28 28mm 19mm proximal, 18mm 13mm distal, large, 152mm length

Loops

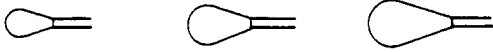
**Billeau**

165mm

L7505-16 small**L7505-17** medium**L7505-18** large**Hovell****L7508-15** 150mm

Mirrors

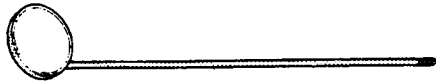
**Handle, Laryngeal**

for use with Laryngeal mirrors 95mm

L7515-01**Laryngeal**

without handle

L7517-06 6mm diameter**L7517-08** 8mm diameter**L7517-10** 10mm diameter**L7517-12** 12mm diameter**L7517-14** 14mm diameter**L7517-16** 16mm diameter**L7517-18** 18mm diameter**L7517-20** 20mm diameter**L7517-22** 22mm diameter**L7517-24** 24mm diameter**L7517-26** 26mm diameter**L7517-28** 28mm diameter**L7517-30** 30mm diameter**Michel Laryngeal**

250mm

L7518-10 10mm**L7518-12** 12mm**L7518-14** 14mm**L7518-16** 16mm**L7518-18** 18mm

Motor Drill

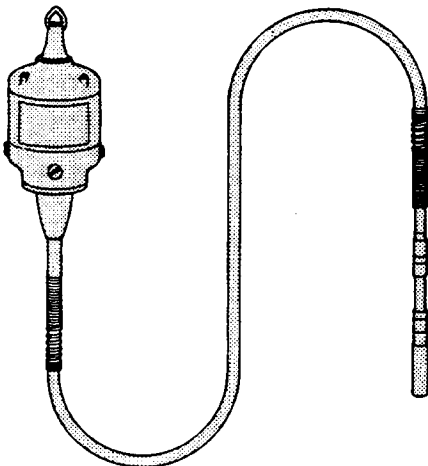
**Citenco**

with reversing switch, variable speed foot switch and flexible cable drive with No. 2 slip joint fitting, 12,000 rpm complete

L7520-01 complete**L7520-02** spare foot switch**L7520-03** spare cable drive

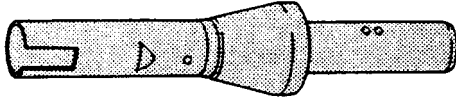
**Kavo Intra-Coupling Device**

to enable Kavo Intra handpieces to be used with Citenko motor
90mm

L7521-01

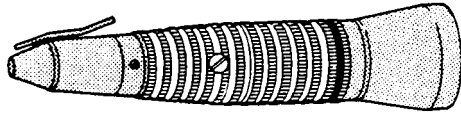
**Kavo Handpiece**

straight, for straight shank burs, requires coupling device for use
with Citenko motor 85mm

L7522-01

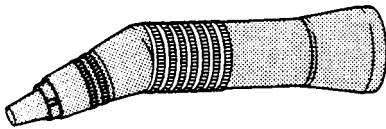
**Kavo Handpiece**

angled, for gear fitting burs, requires coupling device for use
with Citenko motor 70mm

L7522-02

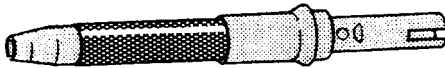
**Kavo Handpiece**

straight, No.2 slip joint 135mm

L7522-03

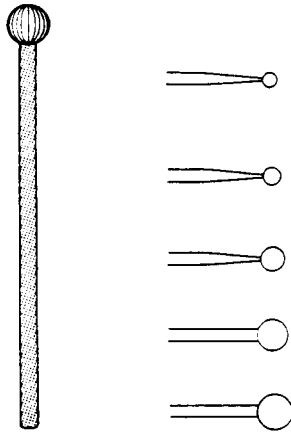
**Burs, Cutting**

round, straight shank, fine, 70mm

L7523-02 2.3mm

L7523-04 3.0mm

L7523-06 4.0mm

L7523-08 5.0mm

L7523-10 6.0mm

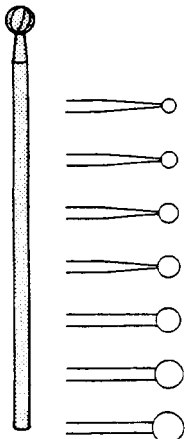
**Burs, Cutting**

round, straight shank, coarse, 70mm

L7523-12 2.3mm

L7523-14 2.7mm

L7523-16 3.0mm

L7523-18 3.5mm

L7523-20 4.0mm

L7523-22 4.5mm

L7523-24 5.0mm

Motor Drill

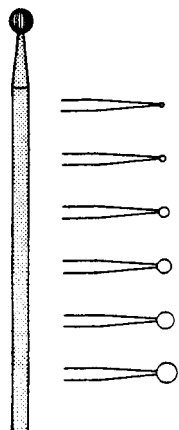
**Burs, Cutting**

round, gear fitting, 70mm

L7523-26 1.8mm

L7523-28 2.3mm

L7523-30 2.7mm

L7523-32 3.1mm

L7523-34 3.5mm

L7523-36 4.0mm

L7523-38 5.0mm

L7523-40 6.0mm

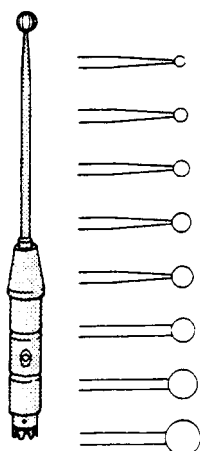
**Burs, Polishing**

straight shank, 70mm

L7523-42 0.70mm

L7523-44 1.00mm

L7523-46 1.75mm

L7523-48 2.30mm

L7523-50 2.75mm

L7523-52 3.15mm

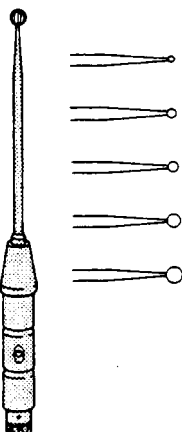
**Burs, Polishing**

gear fitting, 70mm

L7523-54 1.0mm

L7523-56 1.4mm

L7523-58 1.8mm

L7523-60 2.3mm

L7523-62 2.7mm

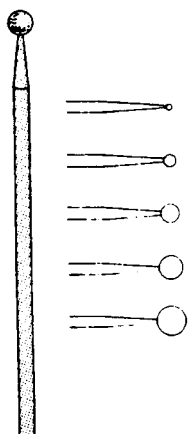
**Burs, Diamond Paste**

straight shank, 70mm

L7523-64 1mm

L7523-66 2mm

L7523-68 3mm

L7523-70 4mm

L7523-72 5mm

Motor Drill

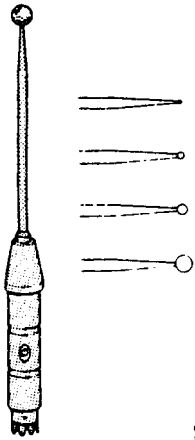
**Burs, Diamond Paste**

gear fitting, 70mm

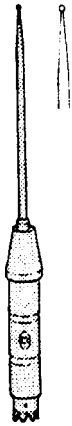
L7523-74 0.6mm**L7523-76** 1.0mm**L7523-78** 1.8mm**L7523-80** 3.1 mm**Cutting Drill**

gear fitting, 70mm

L7523-82 0.6mm**Shea Perforating Bur**

gear fitting, 70mm

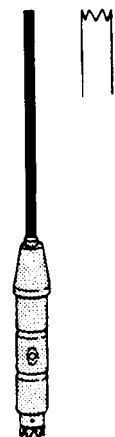
L7523-84 black finish shaft**Shea Footplate Trephine**

gear fitting, 70mm

L7523-86

Motor Drill

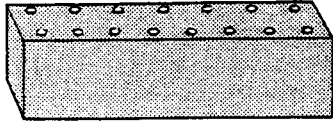
**Bur Stand**

to hold 15 burs with straight shanks
L7524-75 75mm 16mm 19mm

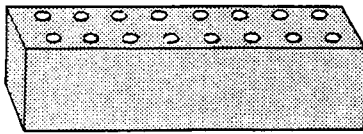

to hold 16 gear fitting burs
L7524-85 85mm 19mm 19mm

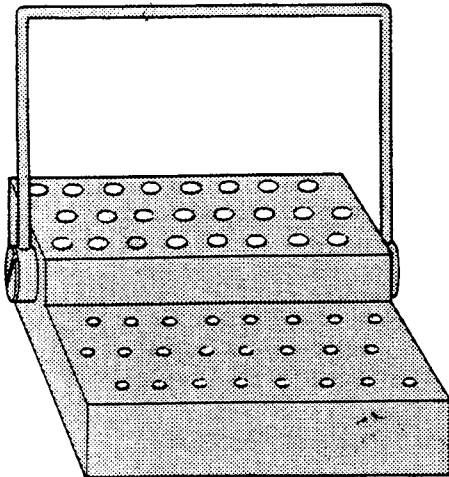

to hold 24 straight shank and 24 gear fitting burs
L7524-86 85mm 90mm 32mm

Mouth Gags

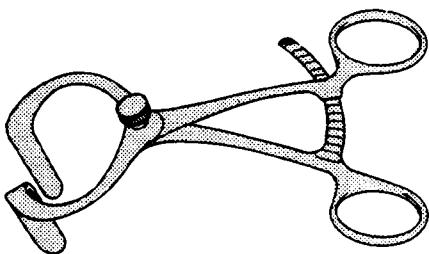
**Doyen**

L7529-01 adult
L7529-02 child

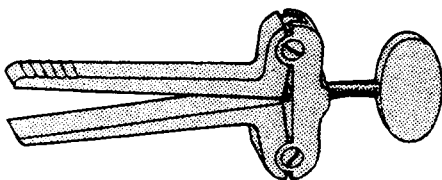
**Heister**

L7531-13 130mm

Mouth Gags

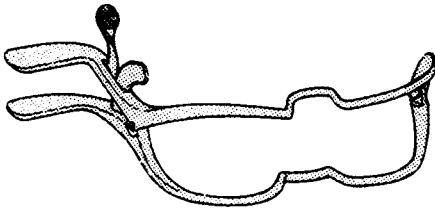
**Jennings**

L7534-09 90mm
 L7534-11 110mm
 L7534-13 130mm
 L7534-15 150mm

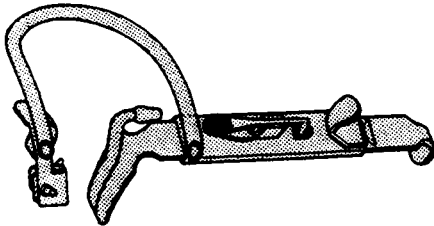
**Davis-Boyle**

frame only
 L7535-01 adult
 L7535-02 child

**Tongue Plates**

plain
 L7536-01 fig. 1 65mm
 L7536-02 fig. 2 75mm
 L7536-03 fig. 3 90mm
 L7536-04 fig. 4 100mm

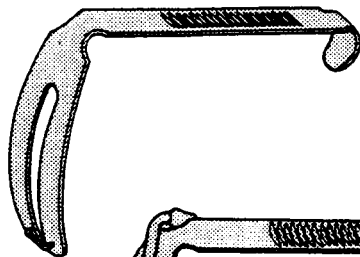
**Tongue Plates**

slotted
 L7537-01 fig. 1 65mm
 L7537-02 fig. 2 75mm
 L7537-03 fig. 3 90mm
 L7537-04 fig. 4 100mm
 L7537-05 fig. 5 115mm

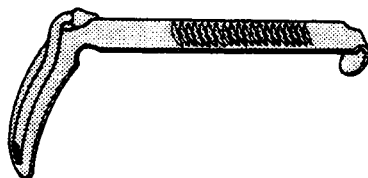
**Tongue Plates**

with anaesthetic tube
 L7540-01 fig. 1 65mm
 L7540-02 fig. 2 75mm
 L7540-03 fig. 3 90mm
 L7540-04 fig. 4 100mm
 L7540-05 fig. 5 115mm

Myringotomes

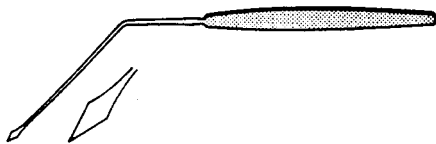
**Agnew**

1mm
 L7545-19

**Poltzer**

reversing into handle, adjustable 170mm
 L7548-17

**Trautmann**

downward cutting 175mm
 L7551-17

**Trautmann**

upward cutting 175mm
 L7551-18

Nasal Cutting Forceps

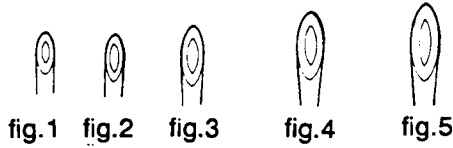
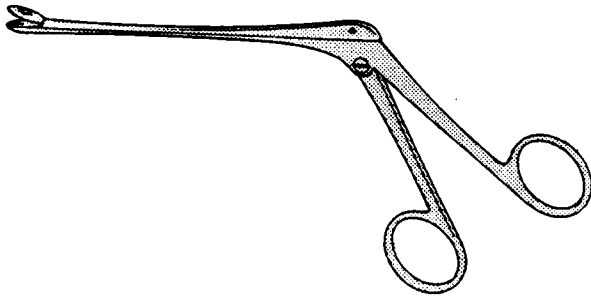

Well-Blakesley

straight , 120mm effective length

L7555-01 fig. 1

L7555-02 fig. 2

L7555-03 fig. 3

L7555-04 fig. 4

L7555-05 fig. 5

curved, 120mm effective length

L7556-01 fig. 1

L7556-02 fig. 2

L7556-03 fig. 3

L7556-04 fig. 4

L7556-05 fig. 5

not to scale

Nasal Forceps

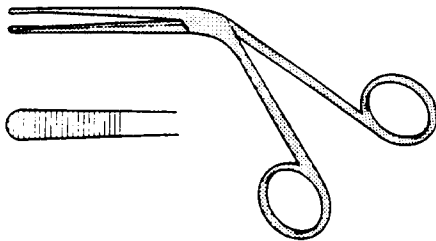

Cawthorne

serrated 165mm

L7560-16

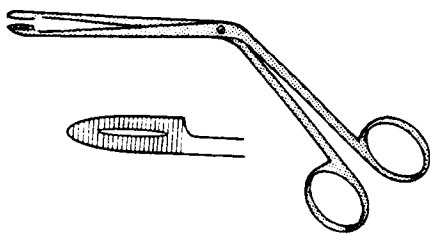

Hartman

serrated, screw joint 175mm

L7563-17

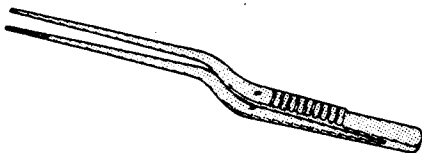

Lucae

serrated 165mm

L7564-16

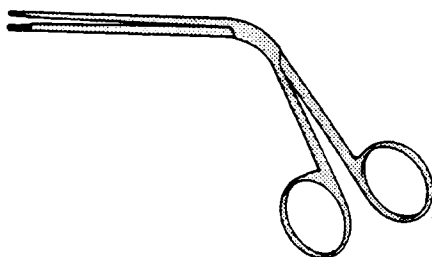

Tilley

serrated, fine tips 165mm

L7566-16

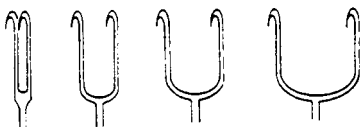

Nasal Hooks

**Joseph**

2 prong sharp
L7570-02 2mm
L7570-05 5mm
L7570-07 7mm
L7570-10 10mm

**Neivert**

L7573-20 200mm

Nasal Instruments

**Freer**

Knife, rounded edge
L7580-19 190mm



Knife, flat rounded blade
L7580-20 190mm

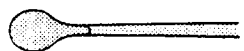

Knife, rounded blade curved on
L7580-21 190mm

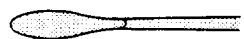

Elevator, sharp edge
L7580-22 190mm



Elevator, dull edge
L7580-23 190mm



Knife, curved to side
L7580-24 190mm



Chisel
L7580-25 190mm

**House Measuring Rods**

black finish, 160mm
L7583-35 3.5mm



black finish, 160mm
L7583-40 4.0mm



black finish, 160mm
L7583-45 4.5mm



black finish, 160mm
L7583-50 5.0mm

Nasal Instruments

**Hughes stapes Mobiliser**

black finish
L7586-16 165mm

Nasal Knives

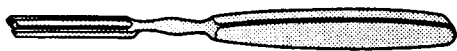
**Ballenger**

straight, 200mm
L7590-06 6mm wide
L7590-08 8mm wide



cranked, 195mm
L7591-06 6mm wide

**Joseph**

L7593-01 straight
L7593-02 curved

**Maltz**

165mm
L7596-16

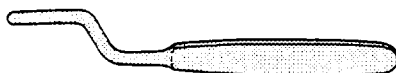
**St Clair Thompson**

first incision, bayonet shape 140mm
L7599-01

Nasal Rasp

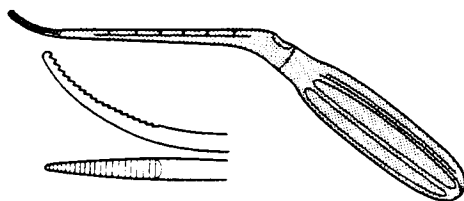
**Watson-Williams**

rounded with convex blade, small 170mm
L7605-01

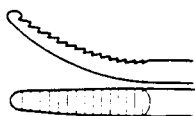

rounded with convex blade, large 170mm
L7605-02

Nasal Snare

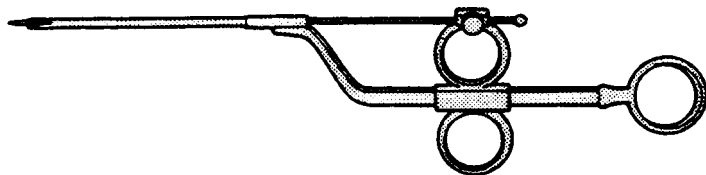

Glegg
Self looping 235mm
L7610-23

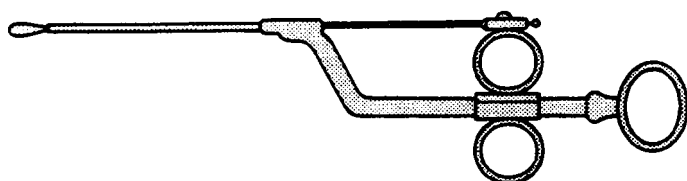

Negus
225mm
L7613-22

Nasal Specula

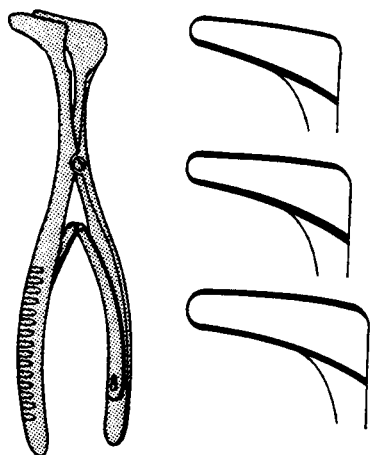

Hartmann-Halle
fig.1
L7620-01
fig.2
L7620-02
fig.3
L7620-03
not to scale

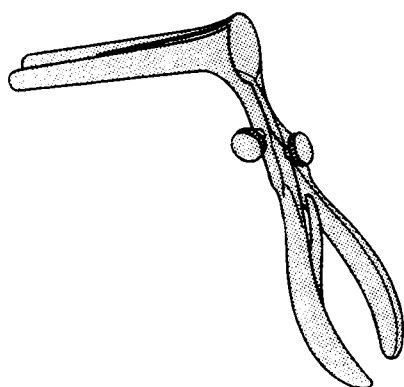

Kilian
plain
L7623-50 blade 50mm
L7623-55 blade 55mm
L7623-65 blade 65mm
L7623-75 blade 75mm
L7623-90 blade 90mm

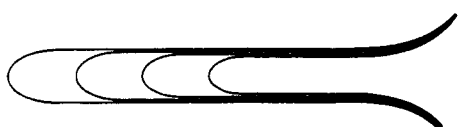

insulated
L7626-55 blade 55mm
L7626-75 blade 75mm
L7626-90 blade 90mm

Nasal Specula

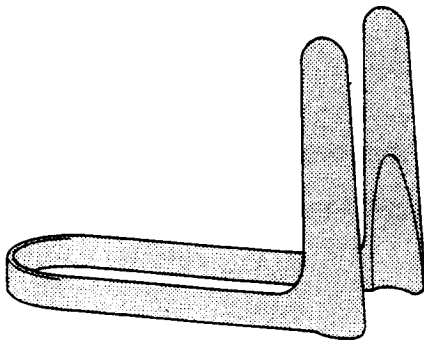

St Clair Thomson

- L7629-38 blade 38mm
- L7629-50 blade 50mm
- L7629-65 blade 65mm
- L7629-75 blade 75mm
- L7629-80 set of 4

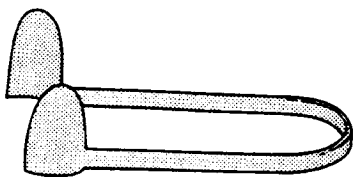

Thudichum

- | | |
|-------------------|-------------------|
| 70mm | insulated, 70mm |
| L7632-01 size 1 | L7635-01 size 1 |
| L7632-02 size 2 | L7635-02 size 2 |
| L7632-03 size 3 | L7635-03 size 3 |
| L7632-04 size 4 | L7635-04 size 4 |
| L7632-05 size 5 | L7635-05 size 5 |
| L7632-06 size 6 | L7635-06 size 6 |
| L7632-07 size 7 | L7635-07 size 7 |
| L7632-10 set of 7 | L7635-10 set of 7 |

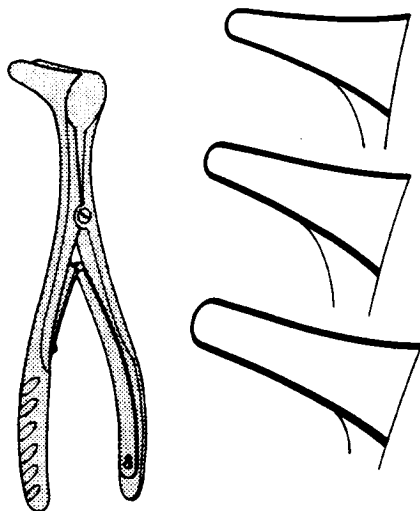

Wien

- fig.1
- L7638-01
- fig.2
- L7638-02
- fig.3
- L7638-03
- not to scale

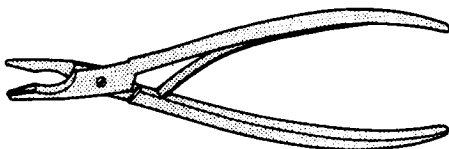

Nibbling Forceps

Lempert

- straight, screw joint
- L7640-15 150mm, 2.5mm jaw

Nodule Forceps

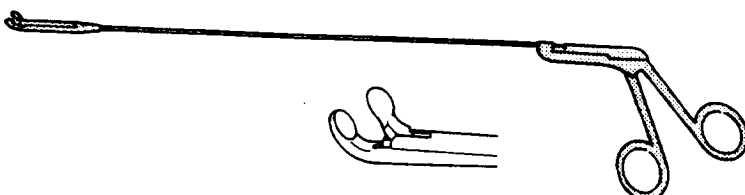

Chevalier Jackson

- upward cup
- L7645-28 280mm effective length
- L7645-35 350mm effective length
- L7645-40 400mm effective length
- L7645-50 500mm effective length
- L7645-55 550mm effective length

Noise Apparatus

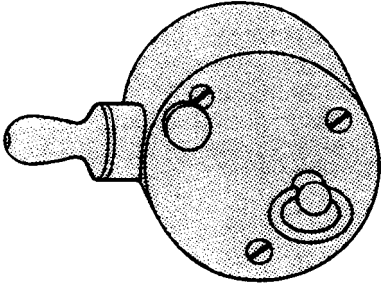

Baran
with bell
L7650-01

Palate Lever

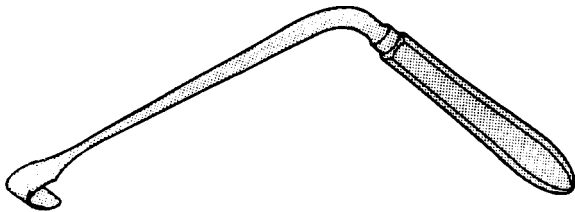

Angell James
225mm
L7655-01

Perforators

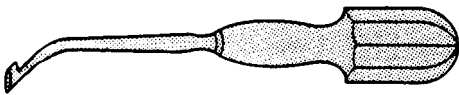

Myles
170mm-
L7660-16 16fg, 5.3mm
L7660-19 19fg, 6.3mm

Pituitary Forceps

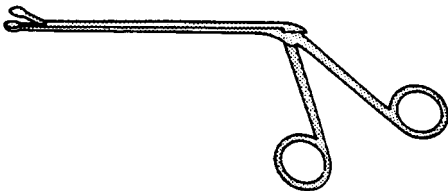

Bateman
crocodile jaws, fenestrated
L7665-15 150mm effective length

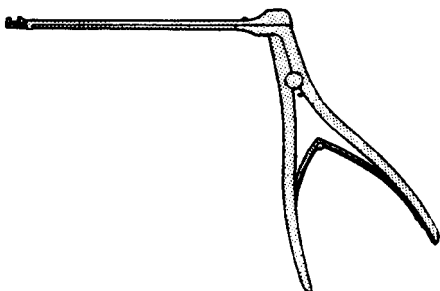

Wilson
flattened tip, 3mm bite
L7668-14 145mm effective length

Probes

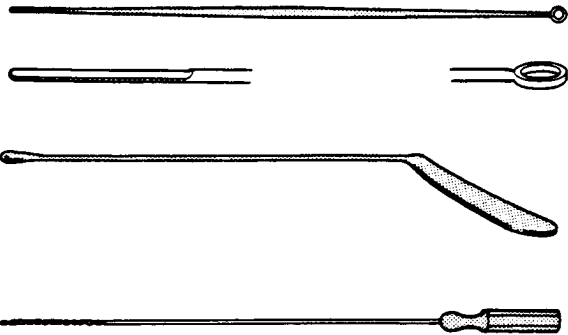

Jobson Horne
double ended
L7675-14 140mm
L7675-17 175mm

Johnson
malleable
L7678-17 175mm

Logan Turner
aluminium
L7681-13 130mm

Punch Forceps

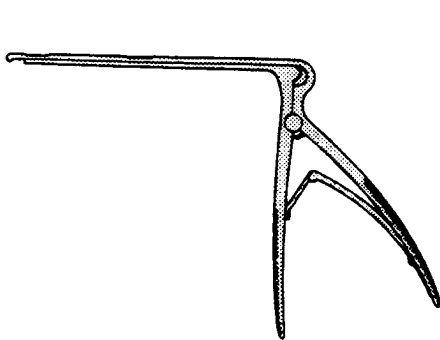

Angell James
downward cutting, 150mm effective length 2mm 60° bite
L7685-01

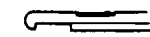

downward cutting, 150mm effective length 2mm right angle bite
7685-02

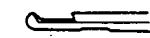

upward cutting, 150mm effective length 2mm right angle bite
L7685-03



upward cutting, 150mm effective length 2mm right angle bite
L7685-04

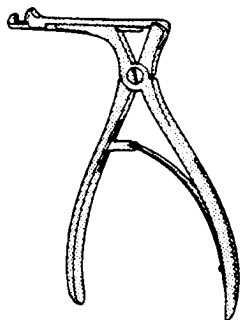

Citelli
73mm effective length
L7688-02 2mm bite

75mm effective length
L7688-04 4mm bite

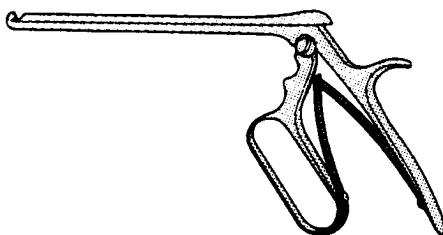

Ferris Smith
upward cutting, black finish, 225mm effective length
L7691-06 5mm bite
downward cutting, black finish, 225mm effective length
L7691-07 5mm bite

Punch Forceps

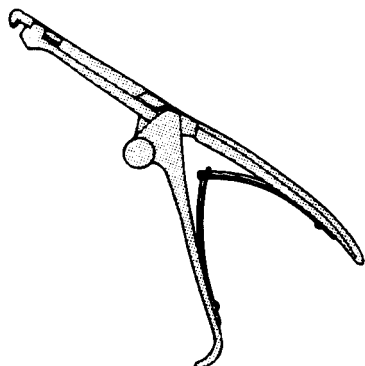

Hajek
L7694-19 195mm

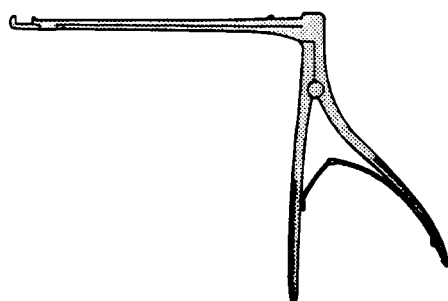

Hajek
upward cutting, 145mm effective length
L7700-04 4mm bite
L7700-05 5mm bite



downward cutting, 145mm effective length
L7700-06 4mm bite
L7700-07 5mm bite

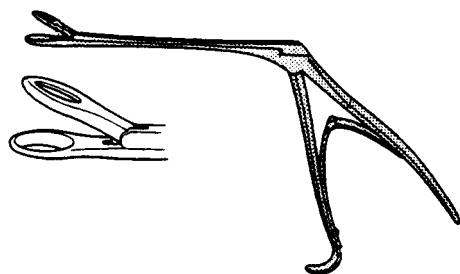

Henckel
spring action
L7701-11 115mm effective length

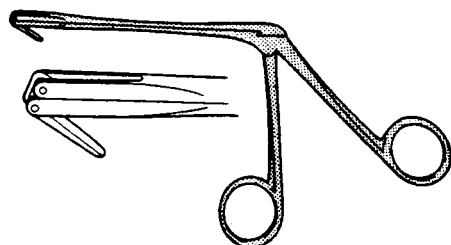

Ostrom
reverse action
L7703-17 175mm effective length

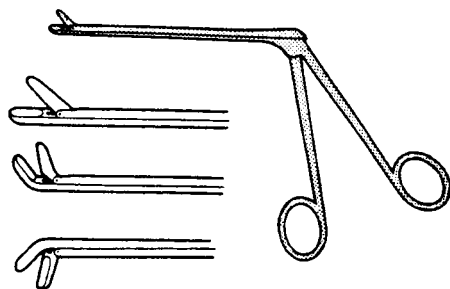

St Bartholomew's
scoop blades, 112mm effective length
L7706-03 straight, 3mm bite
L7706-04 upward cutting, 3mm bite
L7706-05 downward cutting, 3mm bite

Punch Forceps

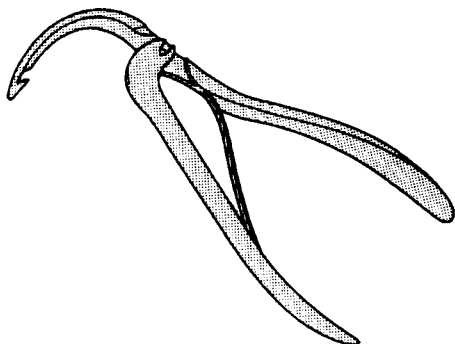

Seymour Jones
L7709-16 160mm

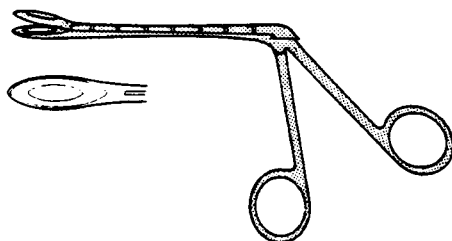

Tilley Henckel
112mm effective length
L7712-45 4.5mm bite
L7712-55 5.5mm bite
L7712-65 6.5mm bite
L7712-80 8.0mm bite

Retractors

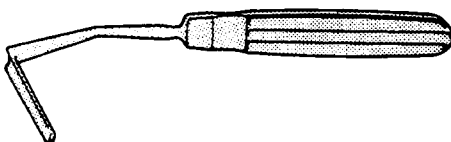

Aufricht
L7720-16 160mm

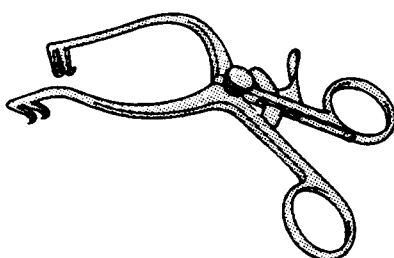

Reichert
L7723-24 240mm

Retractors,
Self-Retaining

Mollison
curved, 2/2 teeth
L7726-13 135mm

Retractors, Self-Retaining

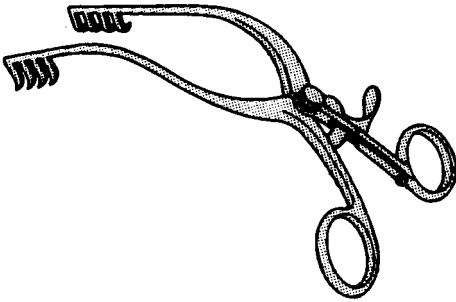

Mollison
curved, 4/4 teeth
L7726-16 165mm

Rugines

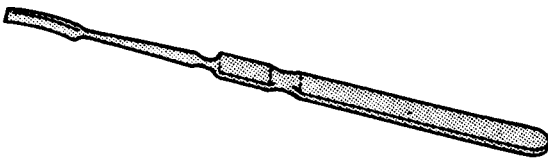

Lempert
broad
L7729-17 170mm

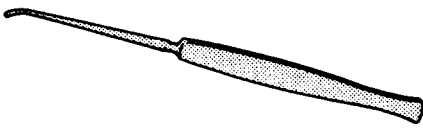

Lempert
narrow
L7729-15 155mm

Scissors

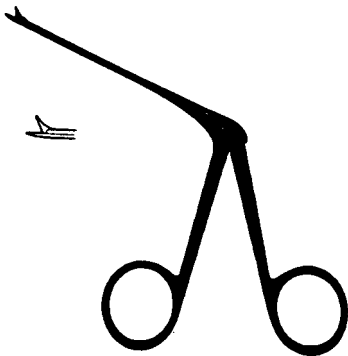

Cawthorne
crocodile, black finish, extra fine 70mm effective length
L7740-70

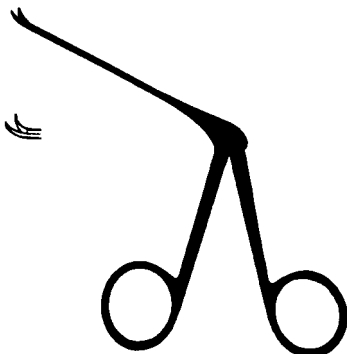

Ormerod
crocodile, black finish, extra fine, curved upwards 70mm effective length
L7743-70

Scissors

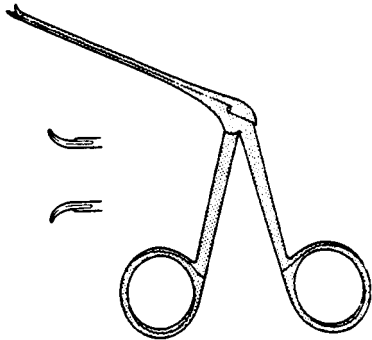
**Portmann**

crocodile, satin finish, 70mm effective length curved to the left

L7746-70

crocodile, satin finish, 70mm effective length curved to the right

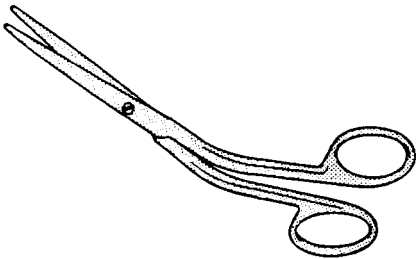
L7746-71**Cottle**

160mm

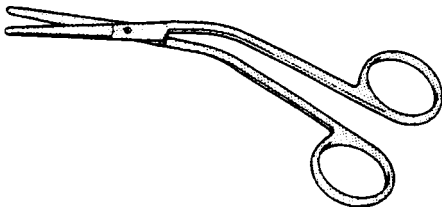
L7750-16**Fomon**

cranked shaft to the left 130mm

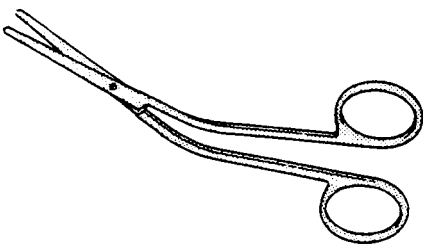
L7753-01**Fomon**

cranked shaft to the right 125mm

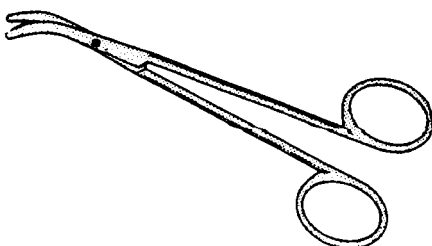
L7753-02**Fomon**

curved 130mm

L7753-03

Scissors

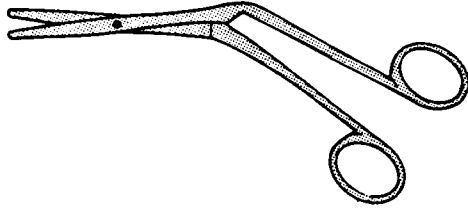
**Knight (Heymann)**

175mm
L7755-17

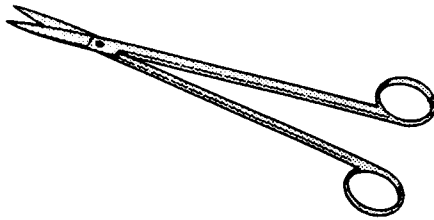
**Scott Stevenson Tonsil**

215mm
L7758-21

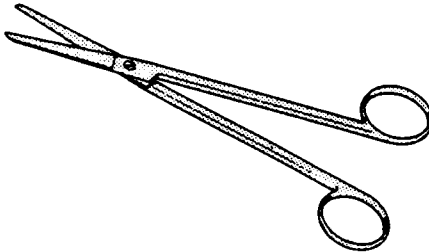
**Wilson Tonsil**

200mm
L7761-20

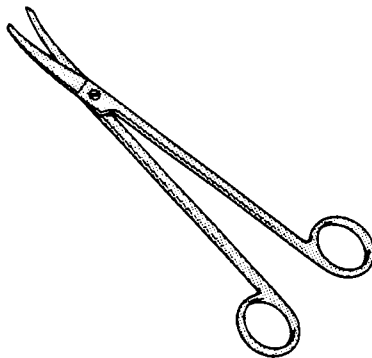
**Woods Tonsil**

190mm
L7764-19

Scoops

**Lempert**

oval, 200mm
L7770-20 No. 0000
L7770-21 No. 000
L7770-22 No. 00
L7770-23 No. 0
L7770-24 No. 1
L7770-25 No. 2

Seeker

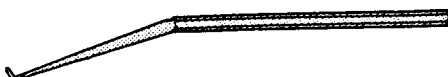
**Dundas-Grant**

L7775-15 150mm

Suction Tubes

**Barron**

225mm

L7780-04 4fg, 1.3mm

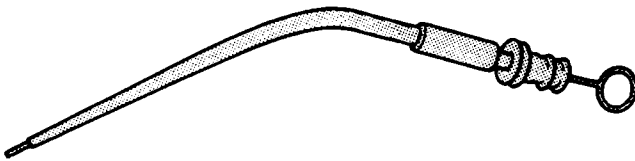
**Formby**

conical tip, 210mm

L7783-10 10fg, 3.3mm

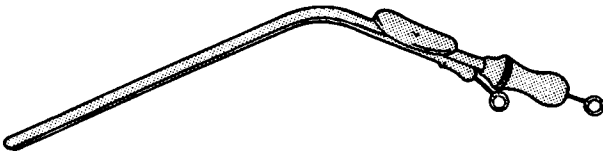
**House**

125mm

L7786-16 16swg 18swg

L7786-18 18swg 20swg

L7786-20 20swg 22 swg

**Insulated**

225mm

L7789-22

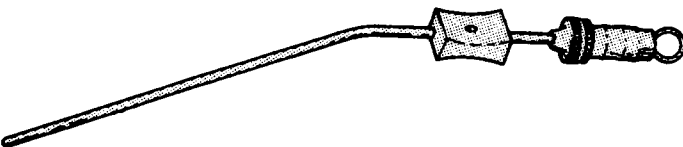
**Lempert**

with stilette, 200mm

L7792-06 6fg, 2mm

L7792-09 9fg, 3mm

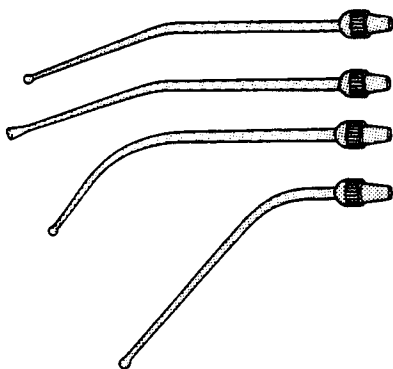
**Magill Universal**

angled, 125mm

L7795-03 3.5mm

L7795-08 8.0mm

curved, 125mm

L7795-09 8.0mm

deep angled, 125mm

L7795-10 8.0mm

**Handle**

L7795-11 to fit above

complete set consisting of 4 suction tubes and handle

L7795-12

Suction Tubes

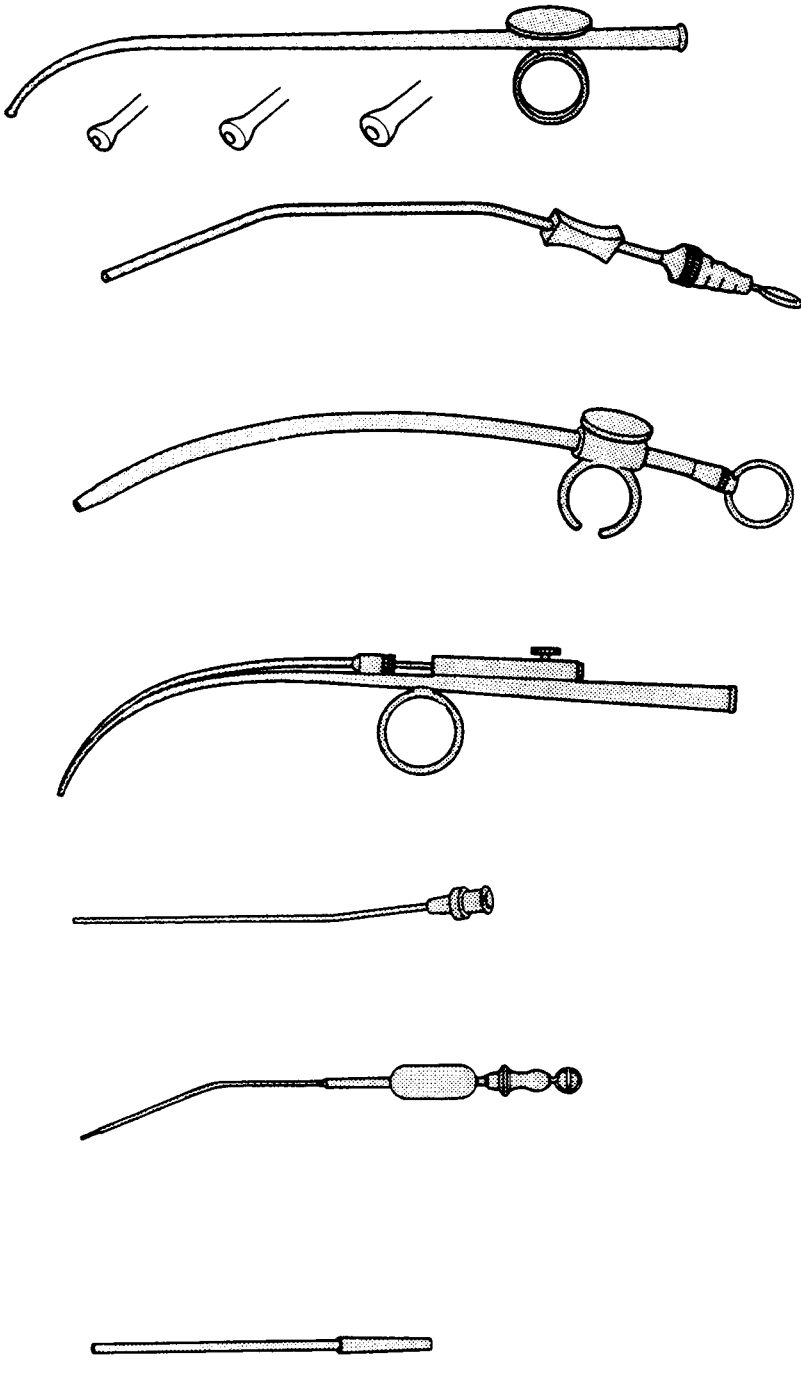
**Magill**

with stilette, 210mm
L7796-02 3.0mm
L7796-03 3.5mm
L7796-04 4.0mm

Remington-Hobbs

L7799-21 215mm

Rowbotham

L7802-28 285mm

Self-Clearing

225mm
L7805-01 1.5mm
L7805-02 2.0mm
L7805-03 3.0mm

Verhoeven

luer, 100mm
L7808-16 16swg
L7808-18 18swg
L7808-20 20swg
L7808-22 22swg
L7808-24 24swg

Zoellner

tube with stilette
L7811-17 175mm

detachable ends
L7812-18 18swg
L7812-20 20swg
L7812-22 22swg
L7812-24 24swg
L7812-26 26swg

Syringe

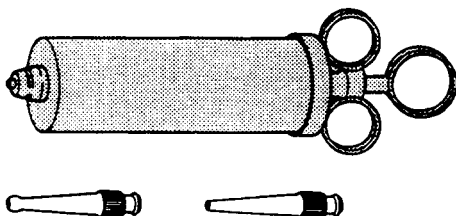
**Aural**

metal syringe complete with 2 tips
L7820-06 50ml
L7820-07 75ml
L7820-10 100ml

Syringe

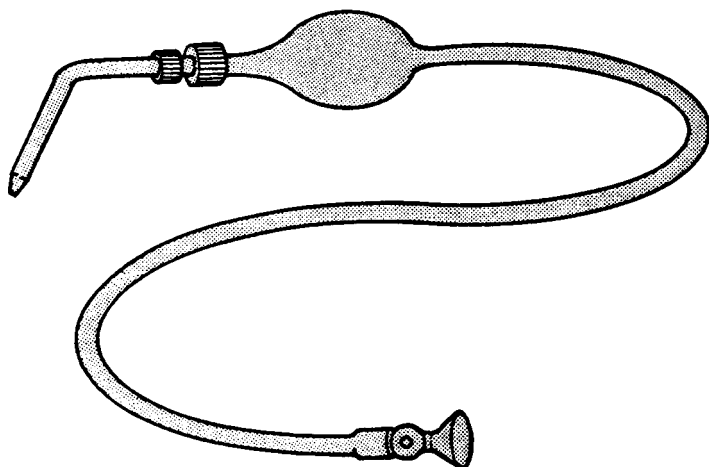

Bacon Aural
L7825-92 920mm

Thyroid Forceps

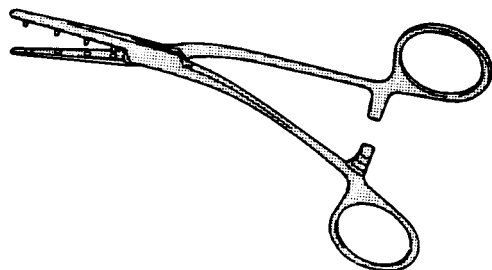

Mastin
L7830-17 left, 170mm
L7830-18 right, 170mm

Tongue Depressors

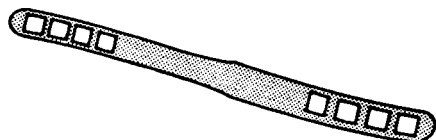

Bruenings
190mm
L7835-19

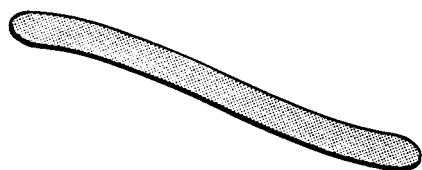

Flat
185mm
L7838-18

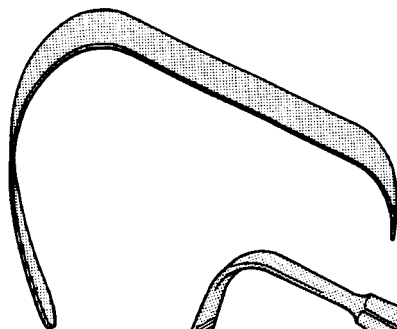

Lack
child 12mm
L7841-12
adolescent 19mm
L7841-19
adult 22mm
L7841-22

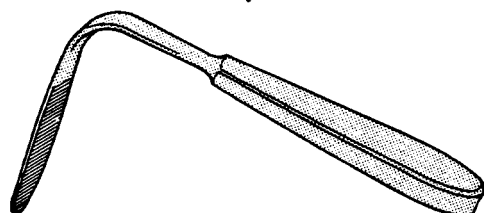

Tobold
145mm
L7844-14

Tongue Forceps

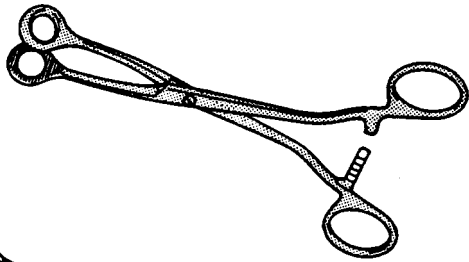

Collin
screw joint 160mm
L7850-16

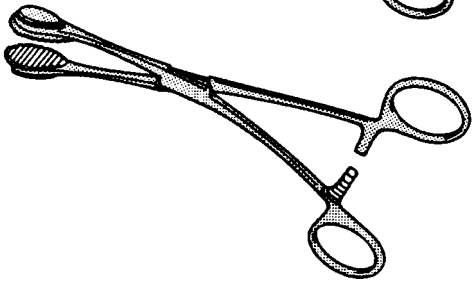

Young
170mm
L7853-17

Tonsil Holding Forceps

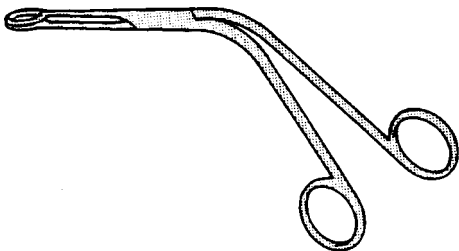

Denis Browne
with rack 200mm
L7860-20
without rack 200mm
L7860-21

Tonsil Seizing Forceps

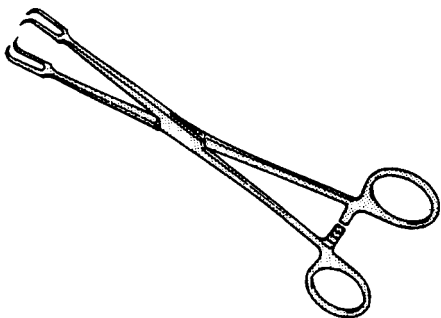

Museux
200mm
L7865-20

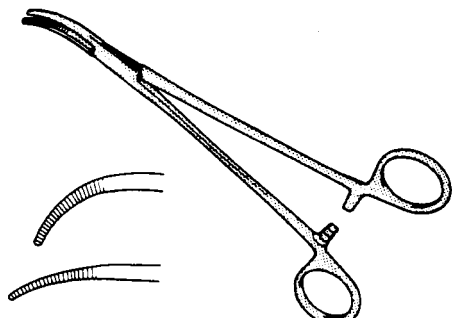

Schmidt
curved 190mm
L7868-19
slightly curved 190mm
L7868-20

Tonsil Snare

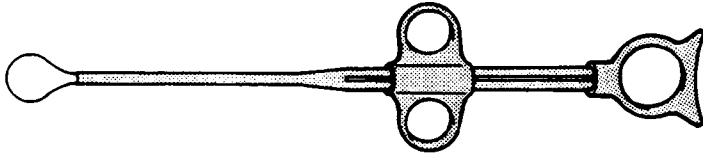

Eve
275mm
L7875-27

Tracheal Dilators

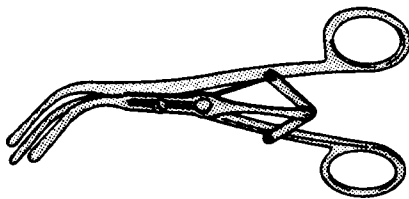

Leborde
125mm
L7885-12
150mm
L7885-15

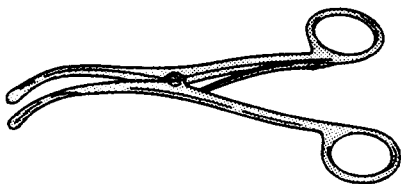

Trousseau
adult 140mm
L7888-14

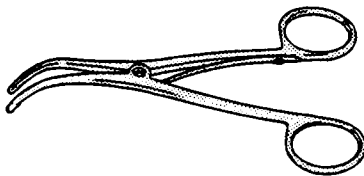

Trousseau
child 125mm
L7888-12

Tracheostomy Tubes

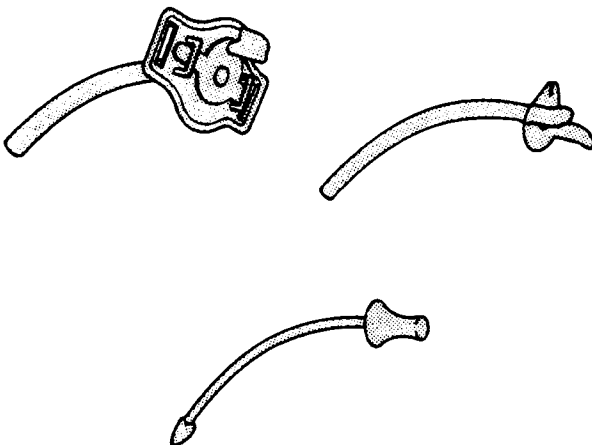

Chevalier Jackson
german silver, with one inner tube and pilot
L7895-12 12fg, 4mm
L7895-15 15fg, 5mm
L7895-18 18fg, 6mm
L7895-21 21fg, 7mm
L7895-24 24fg, 8mm
L7895-27 27fg, 9mm
L7895-30 30fg, 10mm
L7895-33 33fg, 11mm
L7895-36 36fg, 12mm
L7895-39 39fg, 13mm

Tracheostomy Tubes

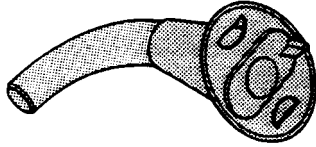
**Moire-Lombard**

Silver, single flange and inner tube
L7898-34 34fg, 11.3mm

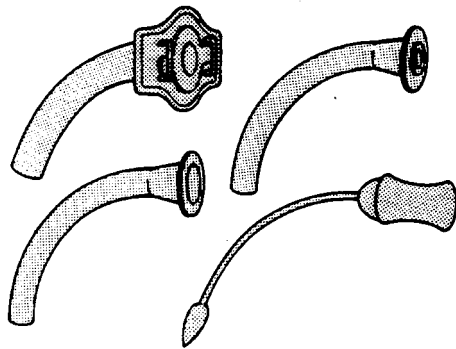
**Negus**

German silver, Inner tube with valve, plain inner tube with pilot

L7901-16	16fg, 5.3mm
L7901-18	18fg, 6.0mm
L7901-20	20fg, 6.7mm
L7901-22	22fg, 7.3mm
L7901-24	24fg, 8.0mm
L7901-26	26fg, 8.7mm
L7901-28	28fg, 9.3mm
L7901-30	30fg, 10.0mm
L7901-32	32fg, 10.7mm
L7901-34	34fg, 11.3mm
L7901-36	36fg, 12.0mm
L7901-38	38fg, 12.7mm
L7901-40	40fg, 13.3mm

Trocars

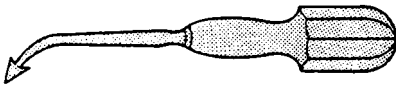
**Tilley Harpoon**

L791 U-17 170mm

**Tilley Lichtwitz**

cannula and tubing mount luer fitting 195mm

L7913-05	5fg
L7913-06	6fg
L7913-07	7fg
L7913-08	8fg
L7913-09	9fg

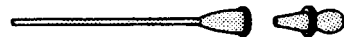

Tuning Forks

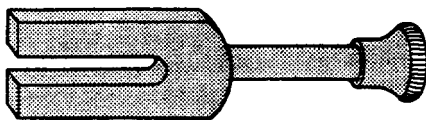
**Alloy**

with foot

L7920-01	CO, 128dv
L7920-02	C1, 256dv
L7920-05	C2, 512dv
L7920-10	C3, 1024dv
L7920-20	C4, 2048dv
L7920-40	C5, 4096dv
L7920-50	set of 6

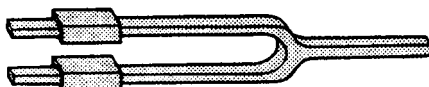
**Gradenigo (Hartmann)**

with weight

L7923-01	C16
L7923-03	C32
L7923-06	C64
L7923-12	C128

Tuning Forks

**Hartmann**

with foot

L7926-01 C0, 128dv**L7926-02** C1, 256dv**L7926-05** C2, 512dv**L7926-10** C3, 1024dv**L7926-20** C4, 2048dv**L7926-40** C5, 4096dv**L7926-50** set of 6

Turbinate Forceps

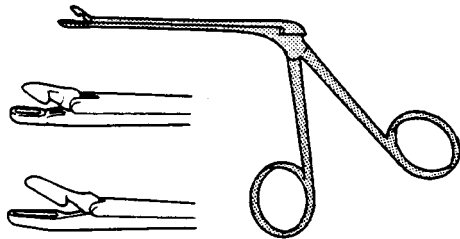
**Grunwald**

narrow punch jaws, 105mm effective length

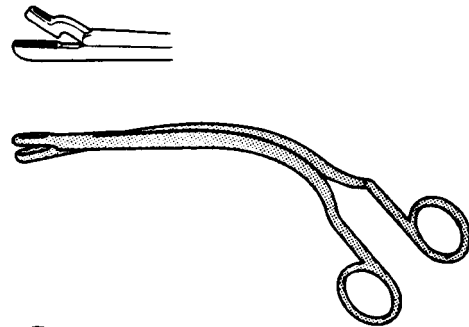
L7935-01 pattern A**L7935-02** pattern B**L7935-03** pattern C**Irwin Moore**

190mm

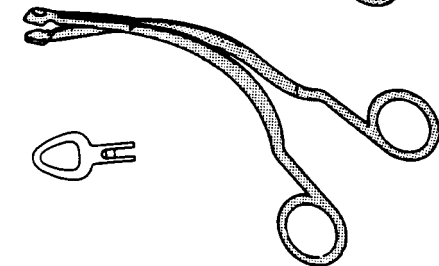
L7938-19**Luc**

heart-shaped, 175mm

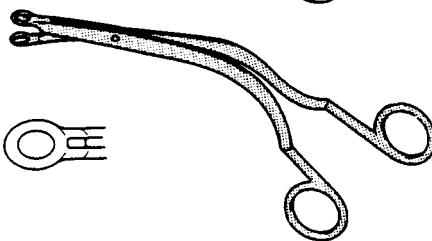
L7941-01 small**L7941-02** medium**L7941-03** large**Luc**

oval, 190mm

L7942-01 small**L7942-02** medium**L7942-03** large

Wool Carriers

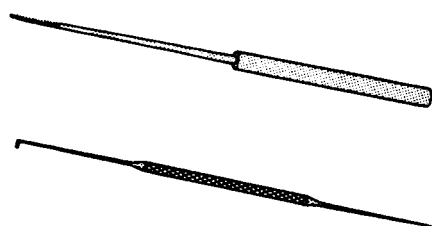
**Heath**

fine 170mm

L7955-17**Musgrove**

175mm

L7958-17

PLASTIC SURGERY



Bone Awls



Kelsey Fry
curved
L8006-17



Kelsey Fry
straight
L8005-14 145mm

Bone Cutting Forceps

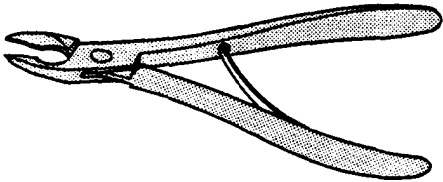

Ward
slight angle
L8010-18 180mm

Bone Holding Forceps

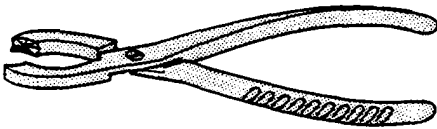

Harrison
screw joint
L8015-19 190mm

Chisels

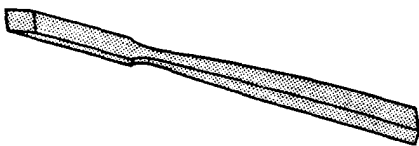

Jenkins
length 145mm
L8025-02 2mm
L8025-04 4mm
L8025-06 6mm
L8025-08 8mm
L8025-10 10mm
L8025-12 12mm
L8025-14 14mm



McIndoe
length 150mm
L8030-09 9mm
L8030-10 10mm
L8030-11 11 mm
L8030-15 15mm

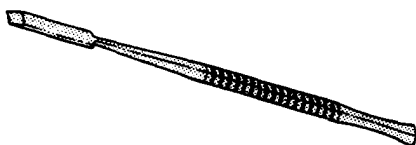

Read
length 180mm
L8035-02 2mm
L8035-03 3mm
L8035-04 4mm
L8035-05 5mm

Chisels

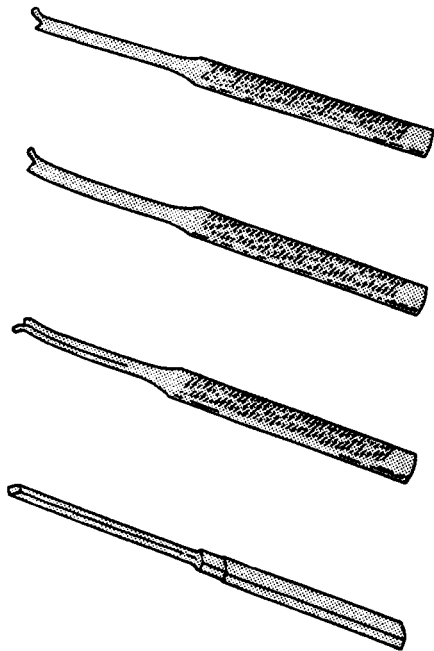
**Silver**

straight
L8045-18 length 180mm

Silver

curved to left
L8046-18 length 180mm

Silver

curved to right
L8047-18 length 180mm

Ward

length 180mm
L8055-03 3mm
L8055-05 5mm

Collar Crushing Forceps

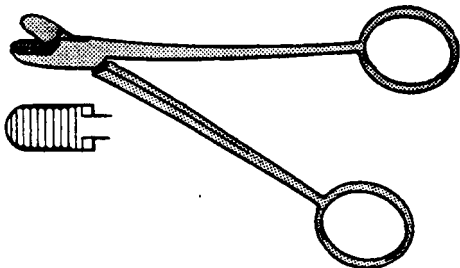
**Denis Browne**

L8060-14 140mm

Curettes

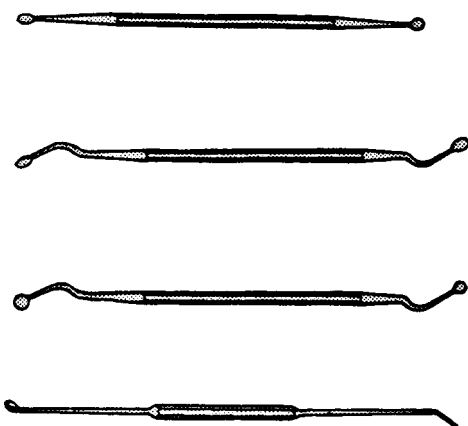
**Exner**

double ended, oval/round end
L8065-17 175mm

Exner

double ended, angled oval ends
L8065-18 175mm

Exner

double ended, angled round ends
L8065-19 175mm

McEwen

double ended
L8067-18 180mm oval
L8067-19 180mm round

Dissecting Forceps

**Mount Vernon**

serrated
L8070-10 100mm

**Watchmaker**

fig 1
L8075-01 125mm



fig 2
L8075-02 115mm



fig 3
L8075-03 115 mm



fig 3A
L8075-04 115mm



fig 4

L8075-05 110mm
fig 5



L8075-06 110mm
fig 7



L8075-07 115mm

Elevators

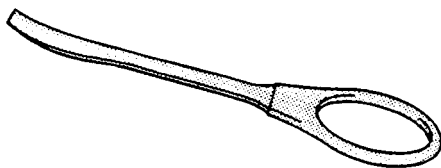
**Bristow Maier**

L8080-24 240mm

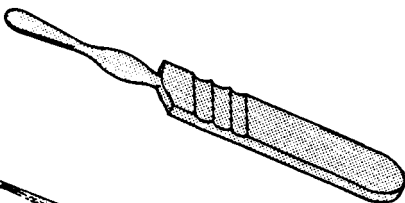
**Fickling**

periosteal
L8085-13 130mm

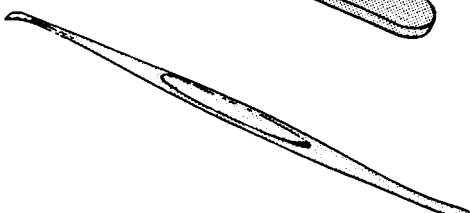
**Howarth**

double ended
L8090-22 220mm

Elevators

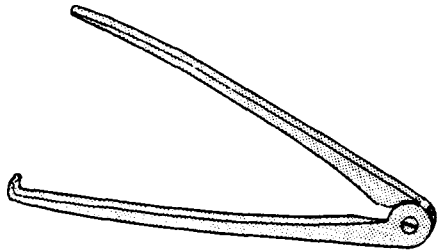

Kilner Malar
L8095-18 180mm

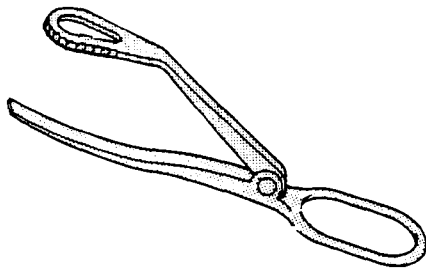

Rowe Zygomatic
L8100-21 215mm

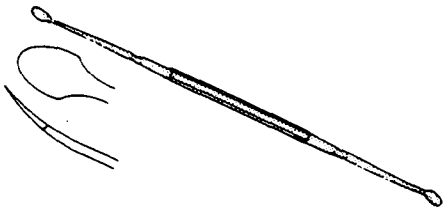

Syme
periosteal, double ended
L8105-17 170mm

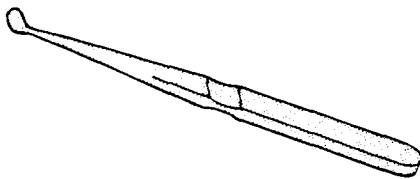

Ward
periosteal, fan shape
L8110-17 170mm

Files



Alveolectomy
double ended
L8115-17 170mm

Fixation Frame

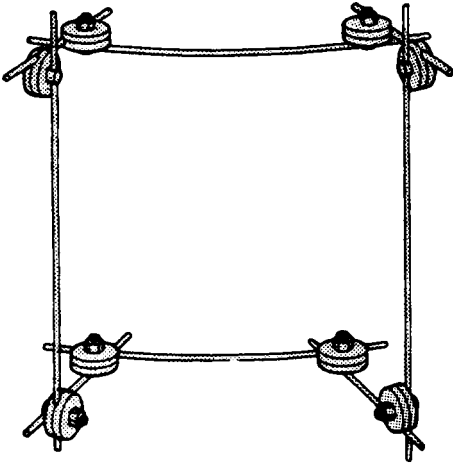

Mount Vernon
L8120-01 complete

Gouges



Read
length 180mm
L8125-02 2mm
L8125-03 3mm
L8125-04 4mm
L8125-05 5mm

Hand Drills

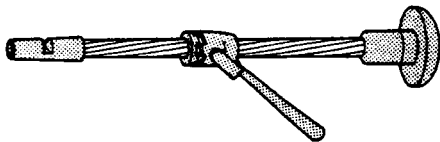

Archimedean
3mm fitting
L8130-19 190mm
Mallets

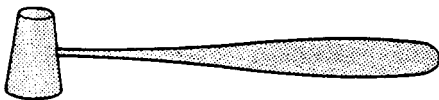

Fickling Dental
190mm 25mm head
L8135-06 6 ¼ oz



Toffee Hammer
L8140-34 340grms

Mapping Pens



Eckhoff
complete
L8145-14 145mm
L8145-15 spare nib for above



Sommerlad
complete with adjustable tip
L8150-15 150mm



Maxilla Instruments

**Awl**

alveolar-pernasal wiring
L8155-22 225mm

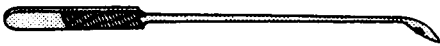
**Awl**

mandibular
L8156-14 140mm

**Awl**

zygomatic suspension
L8157-18 180mm

**Chisel**

Pterigodeus
L8158-23 235mm

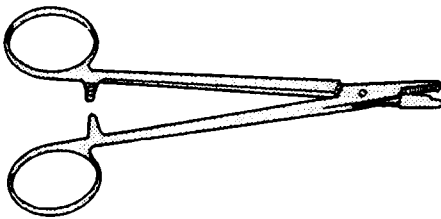
**Forceps**

wire loop
L8159-15 150mm

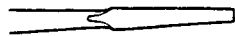
**Osteotome**

length 160mm
L8160-02 2.5mm
L8160-04 4mm

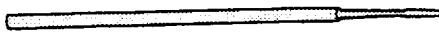
**Raspatory**

curved
L8161-20 205mm 5mm
L8161-21 205mm 8mm
L8161-22 205mm 9mm



Maxilla Instruments

**Raspato**

curved, dole ended
L8162-20 205mm

**Retractor**

Awty osteotomy, 2 required
L8163-21 215mm 12mm
L8163-22 215mm 17mm

Maxilla Instruments



Retractor
chin, holding
L8164-15 155mm

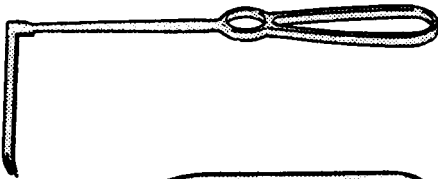

Retractor
forked
L8165-22 220mm, 12mm 70mm blade

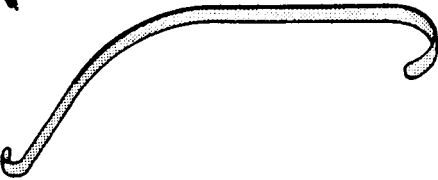

Retractor
prognathism channel, 2 required
L8166-17 170mm



Retractor
Spina Nasalis
L8167-22 220mm, 8mm 28mm blade

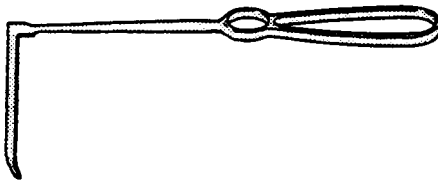

Retractor
stripping
L8168-22 220mm

Mouth Props

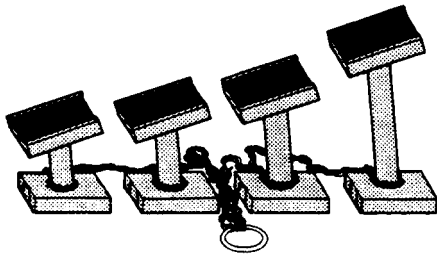

Mushin
L8175-01 set of 4 with chain

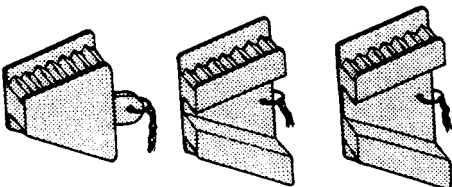

Rubber
L8180-01 small
L8180-02 medium
L8180-03 large
L8180-04 complete on chain

Nasal Saws

**Joseph**

vertical shaft, 185mm

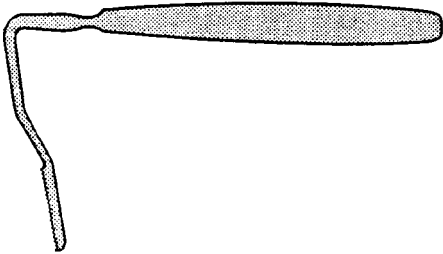
L8185-01 cranked to the left**L8185-02** cranked to the right**Joseph**

horizontal shaft, 125mm 85mm

L8186-01 cranked to the left**L8186-02** cranked to the right**Woakes**

straight

L8190-18 180mm

Needleholders

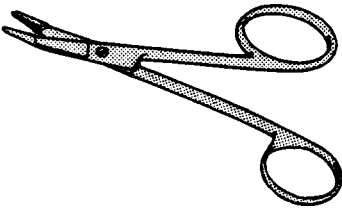
**Foster Gillies**

left hand

L8195-13 130mm

right hand

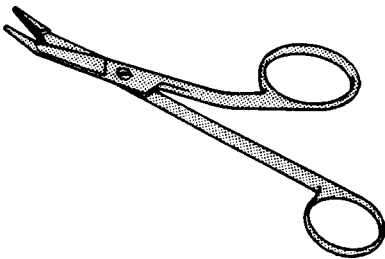
L8195-14 130mm**Gillies**

left hand

L8200-16 165mm

right hand

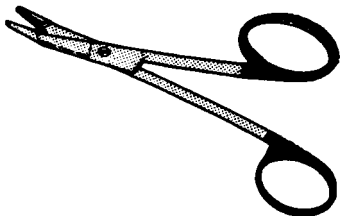
L8200-17 165mmNeedleholders,
Tungsten Carbide**Foster Gillies**

left hand

L8205-13 130mm

right hand

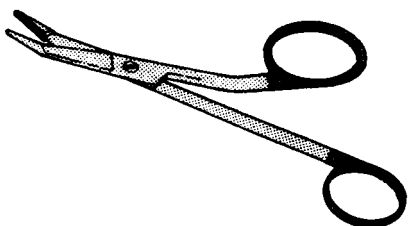
L8205-14 130mm**Gillies**

left hand

L8210-16 165mm

right hand

L8210-17 165mm

Oral Forceps

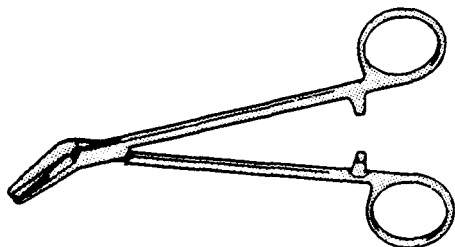
**Fickling**

serrated
L8215-18 180mm



1 / 2 teeth

L8186-18 180mm

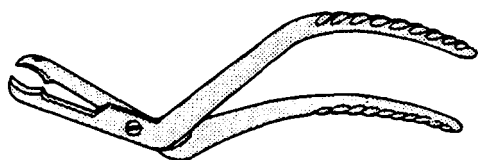
**Harrison Mandible**

screw joint
L8220-21 215mm

**McIndoe Lion**

screw joint
L8225-21 215mm

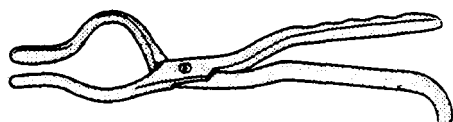
**Rowe Disimpaction**

left, screw joint
L8230-23 230mm

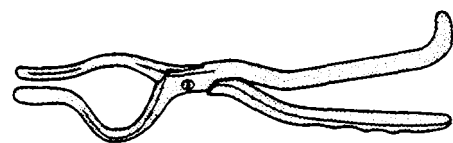
**Rowe Disimpaction**

right, screw joint
L8230-24 230mm

Osteotomes

**Cottle**

straight, length 180mm
L8235-04 4mm
L8235-07 7mm

**Cottle**

curved, length 180mm
L8236-06 6mm

Osteotomes



Gillies

length	140mm
L8240-04	5mm
L8240-07	7mm
L8240-09	9mm
L8240-11	11mm



Read

length	180mm
L8245-04	4mm
L8245-05	5mm



Ward

length	180mm
L8250-03	3mm
L8250-05	5mm

Palate Needles



Riverdin

165mm	
L8255-01	type A

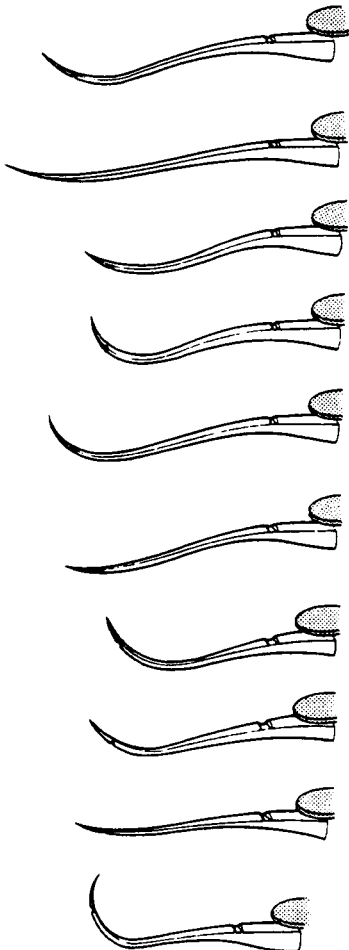

L8255-02	type B
-----------------	--------

L8255-03	type C
-----------------	--------

L8255-04	type D
-----------------	--------

L8255-05	type E
-----------------	--------

L8255-06	type F
-----------------	--------

L8255-07	type G
-----------------	--------

L8255-08	type H
-----------------	--------

L8255-09	type J
-----------------	--------

L8255-10	type K
-----------------	--------



Palate Needles

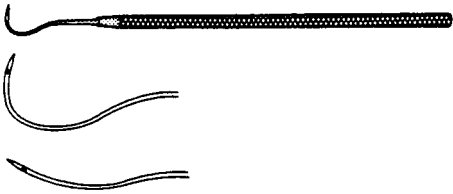

Sadd Holdsworth
with detachable end
L8260-01 deep curve
L8260-02 shallow curve

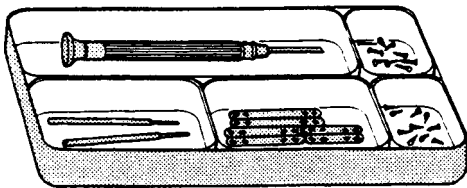

Plating Set
Roberts Mandibular
comprising 6 mandibular plates, 2 each 25mm, 32mm and 38mm,
4 packs of 10
screws, 1 each 6mm 1.5mm, 7mm 2mm, 8mm 1.5mm and
9mm 2mm, 2
shoulder twist drills No.55 and 1 watchmakers screwdriver
L8265-01 complete in aluminium box

Raspatories

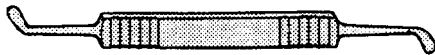

Barsky
L8270-01 double ended



Cleft Palate
L8275-01 curved downwards
L8275-02 curved upwards

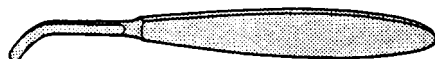

Cleft Palate
curved upwards
L8276-01 left
L8276-02 right

Rasps



Joseph Nasal
file end, fine
L8280-16 165mm



Joseph Nasal
file end, coarse
L8281-16 165mm



Joseph Nasal
fine teeth 1 mm
L8282-16 165mm

Rasps



Joseph Nasal
coarse teeth 1.5mm
L8283-16 165mm



Joseph Nasal
milled end
L8284-16 165mm



Maltz
curved
L8290-16 160mm



Maltz
straight
L8291-17 175mm

Retractors

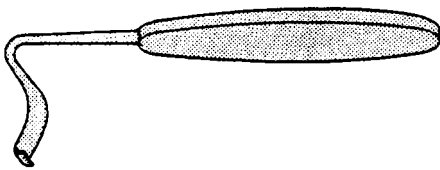

Bowdier-Henry Rake
L8305-19 190mm

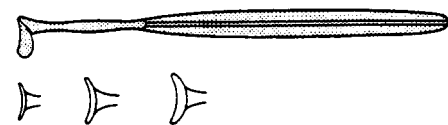

Desmarres
140mm
L8310-12 12.5mm wide
L8310-15 15.5mm wide
L8310-17 17.5mm wide

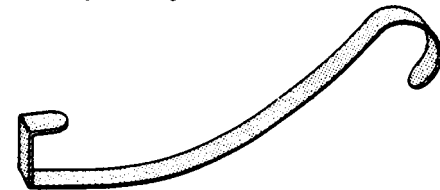

Hajek
upper lip
L8315-16 16.5mm

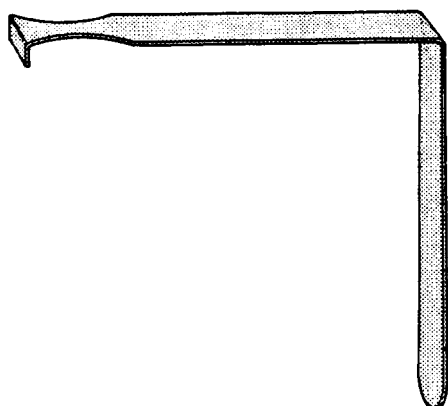

Kay Austin
L8320-14 140mm

Retractors



Kilner Alae
 L8325-85 85mm 10mm
 L8325-86 85mm 13mm

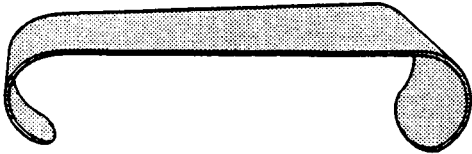

Kilner Cheek
 double ended
 L8330-25 25mm 19mm
 L8330-35 35mm 30mm



Kilner Double Ended
 L8333-15 150mm



Kilner Nasal
 L8335-15 150mm

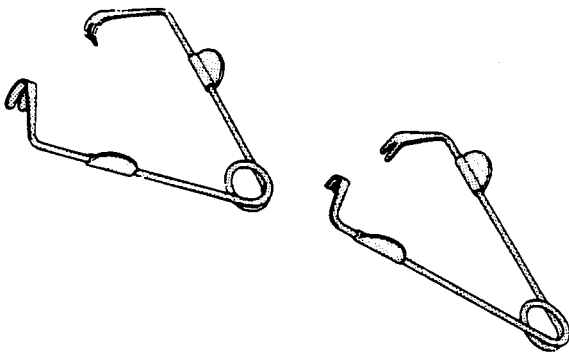

Kilner Skin
 long teeth
 L8340-05 50mm

Kilner Skin
 small teeth
 L8340-06 60mm

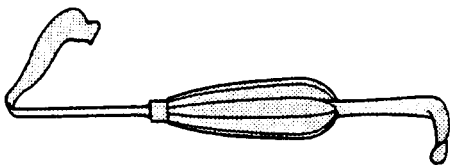

Rowe Buccal
 double ended, curved to left
 L8345-21 215mm
 double ended, curved to right
 L8345-22 215mm

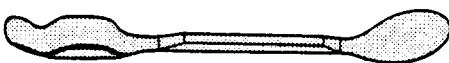

Rowe Lingual
 double ended, curved to left
 L8350-25 250mm
 double ended, curved to right
 L8350-26 250mm

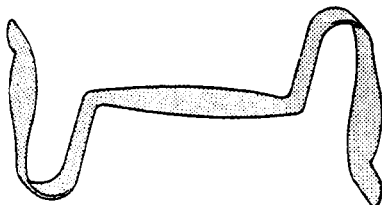

Ward Cheek
 double ended
 L8355-15 150mm

Retractors, Self-Retaining

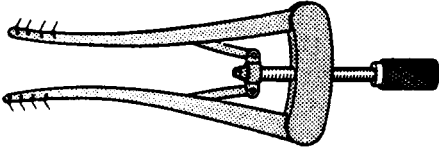

Alms

L8357-07 70mm

Scalpels



Barron Handle

octagonal, for use with No.10,11,12 and 15 blades
L8360-13 130mm

Scissors



Jacobsen Vascular

straight

L8365-17 175mm

curved

L8365-18 175mm

angled on flat

L8365-19 175mm

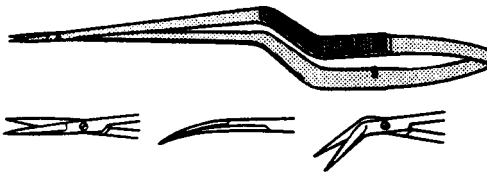

Jacobsen Vascular

straight, cranked

L8366-19 190mm

curved, cranked

L8366-20 190mm

angled on flat, cranked

L8366-21 190mm

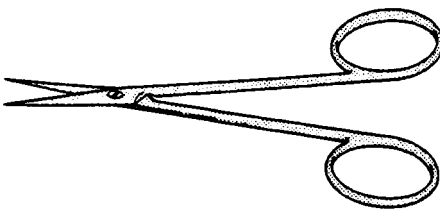

Kiner

straight, sharp points, rounded blades

L8370-11 110mm

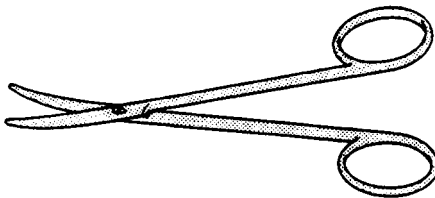

Kiner

curved, blunt points

L8371-11

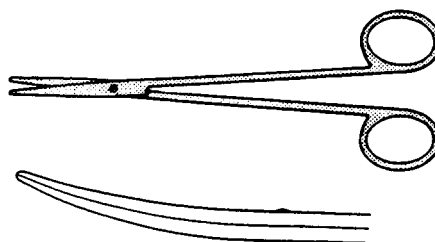

Tonnis-Adson

curved

L8375-17

Scissors,
Tungsten Carbide

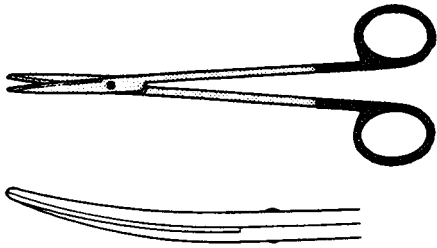

Tonnis-Adson
curved
L8376-17

Septum Forceps

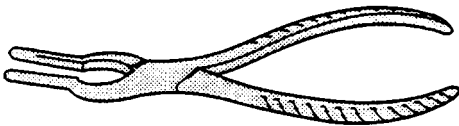

Asch
L8380-23 235mm

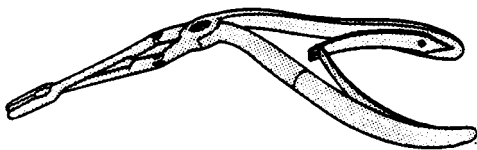

Jansen-Middleton double action
L8385-18 185mm



Walsham
redressing, left
L8390-22



Walsham
redressing, right
L8390-23 220mm



Walsham
straight
L8390-21 215mm

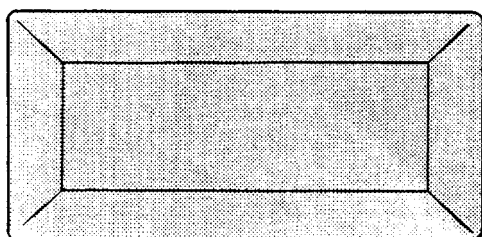

Wood
bevelled edge
L8395-18 180mm 90mm

Skin Graft Boards

Skin Graft Knives

**Braithwaite**

complete with 5 blades
L8400-30 305mm

**Cobbett**

complete with 5 blades
L8405-30 305mm
L8406-01 spare blades for Braithwaite and Cobbett knives

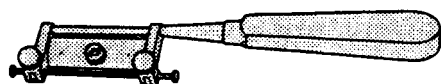
**Silver**

complete with blade, 190mm
L8410-01 right hand
L8410-02 left hand
L8410-03 spare blade

Skin Hooks

**Barsky**

double, adjustable
L8415-15 150mm

**Gillies**

185mm
L8420-01 small
L8420-02 large

**Kilner**

L8425-14 140mm

**Mcindoe**

L8430-19 190mm

**Mcindoe Double**

length 150mm
L8435-09 9mm
L8435-10 10mm
L8435-11 11 mm



Suture Forceps



Mustarde
L8440-15 150mm

Suture Pusher



Bateman
L8445-24 240mm

Traction Bow

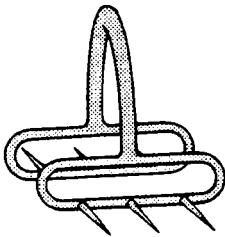

Logans
L8450-13 13mm

Wire Forceps

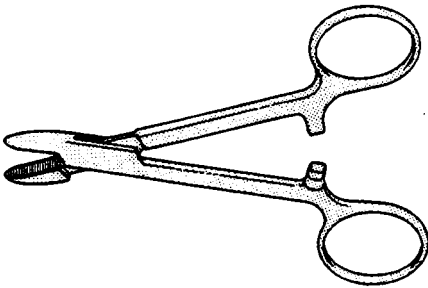

Hayton Williams
L8455-12 112mm

Wire Instruments

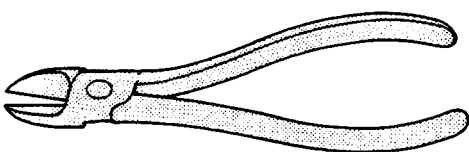

Cutters
L8460-16mm 160mm

OPHTHALMIC SURGERY



Cannula

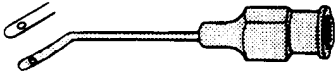

Castroviejo
L8505-01 1.0mm
L8505-02 1.5mm



Luer Lock
L8510-27 27°

Cystotomes



Graefe
L8515-01 fig 1

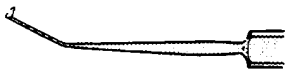

Graefe
L8515-02 fig 2

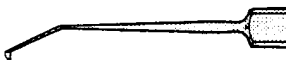

Graefe
L8515-03 fig 3

Diathermy

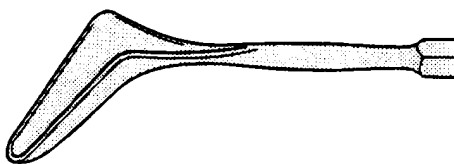

Arruga Reflector
L8520-01 insulated

Erisphake

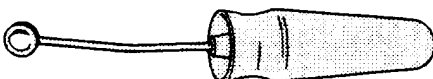

Dastoor
L8525-06 60mm, complete

Eye Chisels

**West**

L8530-17 175mm, flat

**West**

L8530-18 175mm

Eye Curettes

**Meyhoefer**

L8535-01 0.5mm

L8535-02 1.0mm

L8535-03 1.5mm

L8535-04 1.8mm

L8535-05 2.0mm

L8535-06 2.5mm

L8535-07 3.5mm

L8535-08 4.0mm

L8535-09 4.5mm

Eye Forceps

**Castroviejo Capsular**

cross action

L8540-10 100mm, small

**Castroviejo Capsular**

cross action

L8540-11 100mm, large

**Elschnig Capsular**

L8545-10 100mm

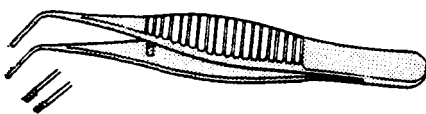
**Hess Capsular**

straight, angled end

L8550-60 60mm

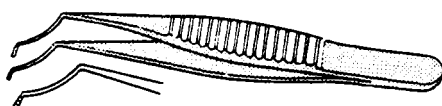
**Hess Capsular**

curved, angled end

L8551-60 60mm

Eye Forceps

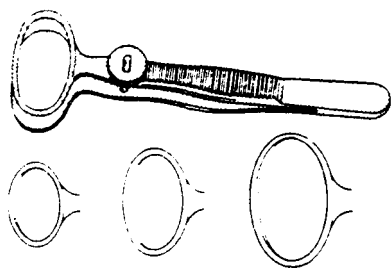
**Chalazion Desmarres**

L8555-90 90mm, small
 L8555-91 90mm, medium
 L8555-92 90mm, large

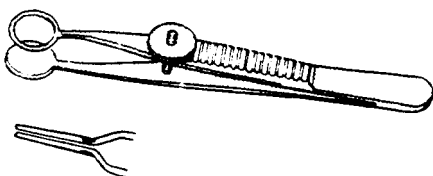
**Chalazion Lambert**

L8560-90 90mm

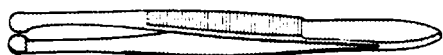
**Beer Cilia**

L8565-90 90mm

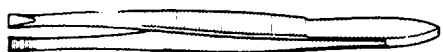
**Douglas Cilia**

square ended
 L8570-90 90mm

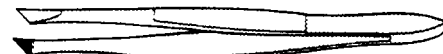
**Epilation**

L8573-11 115mm

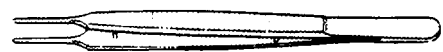
**Barraquer Suture**

grooved
 L8575-10 100mm

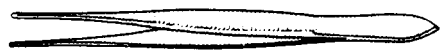
**Bonaccolto Suture**

grooved
 L8580-10 100mm

**Lister Suture**

1/2 teeth
 L8585-11 110mm

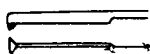
**McPherson Suture**

grooved
 L8590-10 100mm

**McPherson Suture**

1/2 teeth
 L8591-75 75mm

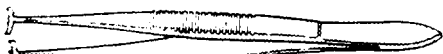
**Barraquer Fixation**

L8595-10 100mm

Eye Forceps



Bishop-Harman Fixation

serrated
L8600-90 90mm



serrated, fine
L8600-91 90mm



1/2 teeth
L8601-90 90mm



1/2 teeth, fine
L8601-91 90mm



Fixation

2/3 teeth
L8605-11 110mm

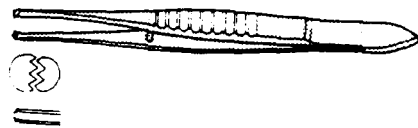

Fixation

3/4 teeth
L8606-11 110mm

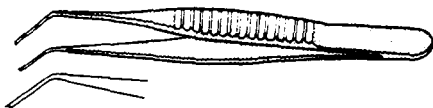

Hess Fixation

curved, 1/2 teeth
L8610-70 70mm



Hess Fixation

double angled, 1/2 teeth
L8611-70 70mm

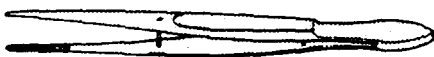

Moorfield Fixation

fine points
L8615-90 90mm



Barraquer (Colibri) Iris

1/2 teeth
L8620-70 70mm



Eye Forceps

**Graefe Iris**

straight, serrated, 70mm

L8625-06 0.5mm jaw**L8625-07** 0.7mm jaw**L8625-10** 1.0mm jaw**Graefe Iris**

curved, serrated, 70mm

L8626-06 0.5mm**L8626-07** 0.7mm**L8626-10** 1.0mm**Graefe Iris**

straight, 1/2 teeth, 70mm

L8627-06 0.5mm**L8627-07** 0.7mm**L8627-10** 1.0mm**Graefe Iris**

curved, 1/2 teeth, jaw

L8628-06 0.5mm jaw**L8628-07** 0.7mm jaw**L8628-10** 1.0mm jaw**Iris**

straight, serrated

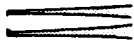
L8635-09 90mm**L8635-11** 115mm**Iris**

straight, 1/2 teeth

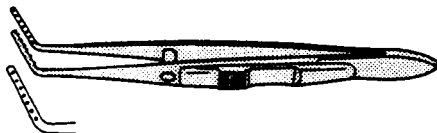
L8636-09 90mm**L8635-11** 115mm**Jameson Strabismus**

left

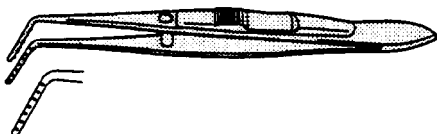
L8640-10 100mm**Jameson Strabismus**

right

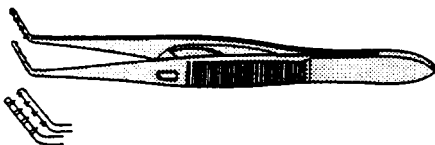
L8640-11 100mm**Prince Strabismus**

right

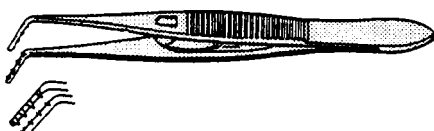
L8645-10 100mm**Prince Strabismus**

right

L8645-11 100mm

Eye Forceps

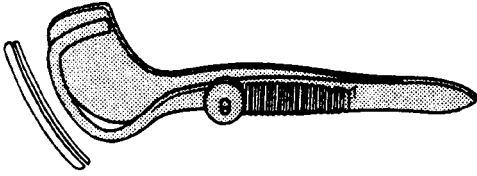
**Snellen Entropian**

left
L8650-10 100mm

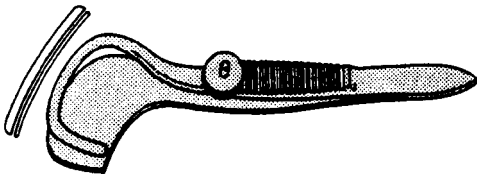
**Snellen Entropian**

right
L8650-11 100mm

Eye Hooks

**Arruga**

L8655-01 left

**Arruga**

L8656-02 right

**Graefe**

L8660-12 120mm, blunt

**Graefe**

L8660-13 120mm, sharp

**Green**

L8665-01 muscle

**Guthrie**

L8670-12 120mm, sharp, small
L8670-13 130mm, sharp, large

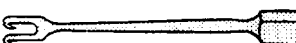
**Rollet**

L8675-12 125mm, sharp, 2 prong

Eye Hooks



Rollet
L8675-13 135mm, sharp, 4 prong

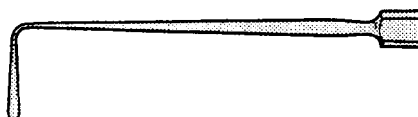

Stevens
L8680-01 large



Stevens
L8680-02 small

Eye Knives

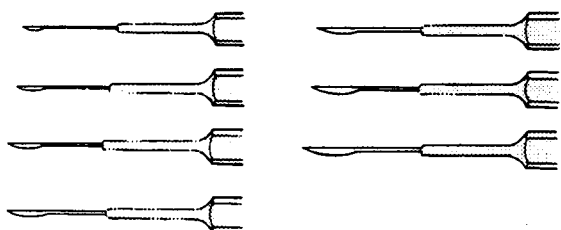

Bowman
L8685-04 0.4mm
L8685-05 0.5mm
L8685-06 0.6mm
L8685-07 0.7mm
L8685-08 0.8mm
L8685-09 0.9mm
L8685-10 1.0mm

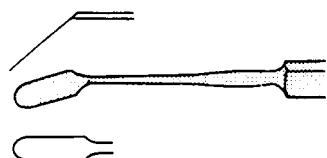

Elschnig
L8690-01 corneal graft

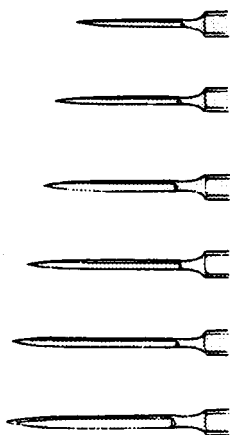

Graefe Catect
L8695-17 1.75mm
L8695-20 2.0mm
L8695-22 2.25mm
L8695-25 2.5mm
L8695-27 2.75mm
L8695-30 3.0mm

Eye Knives

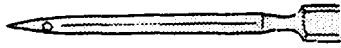

Johnson
L8698-01 with eye

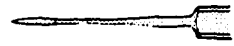

Knapp
L8700-01 size 1
L8700-02 size 2
L8700-03 size 3

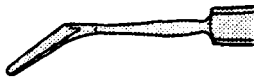
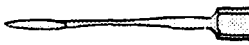
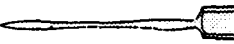

Lundsgaard Sclerotome
L8705-61 angled



Took
L8715-01 corneal



Webber Canaliculus
L8720-01 straight



Webber Canaliculus
L8720-02 shallow curve



Webber Canaliculus
L8720-03 curved



Scalpel
L8710-01 size 1
L8710-02 size 2
L8710-03 size 3
L8710-04 size 4
L8710-05 size 5
L8710-06 size 6

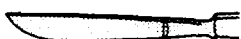

Eye Needles



Bowman
L8725-01 with stop

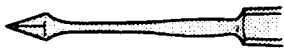
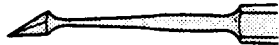

Desmarres Paracentis
L8730-01 angled
L8730-02 straight

Eye Probes



Bowman (Liebriech)
double ended, silver
L8735-01 0000/000
L8735-02 000/00
L8735-03 00/0
L8735-04 0/1
L8735-12 1/2
L8735-23 2/3
L8735-34 3/4
L8735-45 4/5
L8735-56 5/6
L8735-67 6/7
L8735-78 7/8

Eye Ruginer

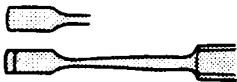

Rollet
L8740-01 for lachrymal sac

Eye Scissors

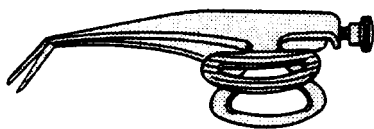

Barraquer
angled to side, 55mm
L8745-06 5mm blade
L8745-07 7mm blade
L8745-10 10mm blade

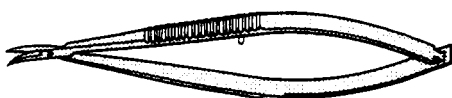

Castroviejo
curved on flat
L8747-10 100mm

Castroviejo
angled to side
L8748-10 100mm

Eye Scissors

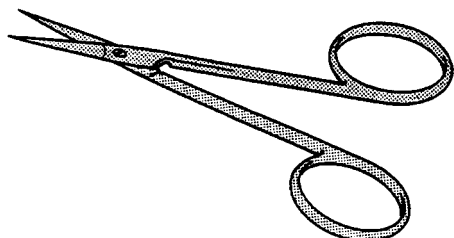
**Elliot Iris**

sharp points

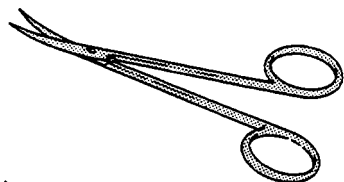
L8751-85 85mm**Enucleation**

curved on flat

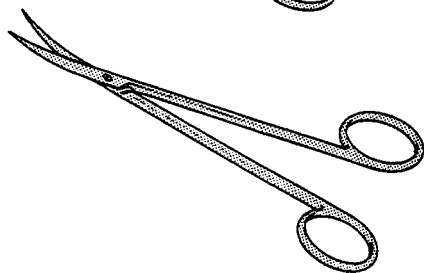
L8753-09 90mm**Enucleation**

curved on flat

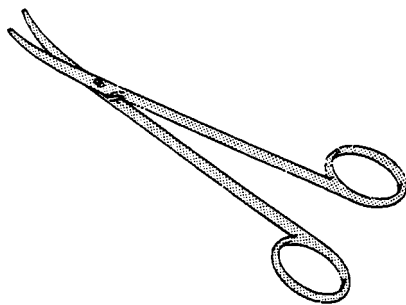
L8753-11 115mm**Enucleation**

curved on flat, extra strong

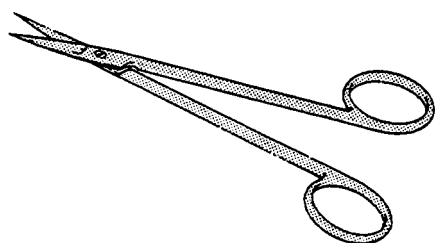
L8753-12 115mm**Glasgow Iris**

straight, fine sharp points

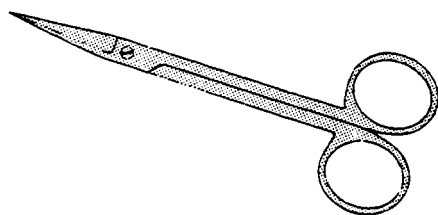
L8755-10 106 100mm**Iris**

straight, sharp

L8758-09 90mm**L8758-11** 110mm

straight, lightweight, sharp

L8759-09 90mm**L8759-11** 110mm

straight, super lightweight, sharp

L8760-11 110mm

ANETIC
AID

Eye Scissors

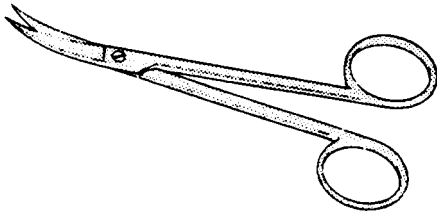
**Iris**

curved, sharp
L8761-09 90mm
L8761-11 110mm
 curved, lightweight, sharp
L8762-09 90mm
L8762-11 11mm
 curved, super lightweight, sharp
L8763-11 110mm

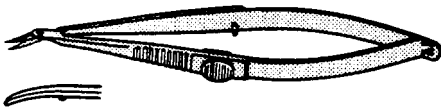
**Katzin**

curved to the left, sharp
L8766-10 100mm

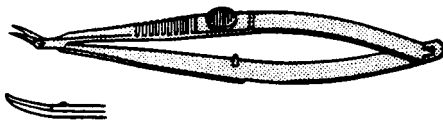
**Katzin**

curved to the right, sharp
L8766-11 100mm

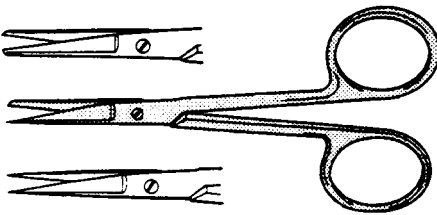
**Knapp**

straight, blunt/blunt
L8768-10 105mm
 straight, blunt/sharp
L8768-11 105mm
 straight, sharp/sharp
L8768-12 105mm

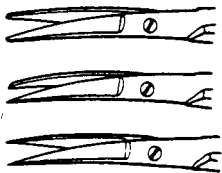
**Knapp**

curved, blunt/blunt
L8769-10 105mm
 curved blunt/sharp
L8769-11 105mm
 curved, sharp/sharp
L8769-12 105mm

**Labrange**

double curve
L8771-11 115mm

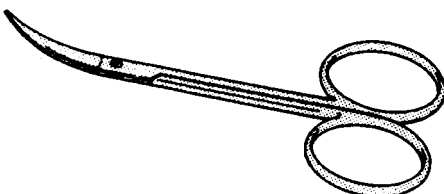
**Lagrange Sclerotomy**

curved
L8772-90 90mm

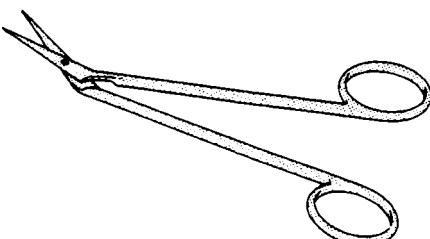
**Maunoir Iris**

angled, sharp
L8775-11 110mm

Eve Scissors

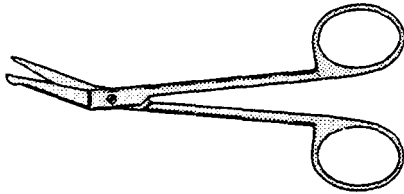

Maunoir Iris
angled, probe/sharp
L8775-12 110mm

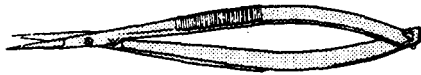

Noyes
straight, sharp/sharp
L8778-12 120mm

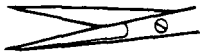

Noyes
straight, blunt/sharp
L8778-13 120mm

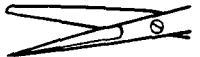

Noyes
straight, blunt/blunt
L8778-14 120mm



Noyes
Angled, sharp/sharp
L8779-12 120mm



Noyes
angled, blunt/sharp
L8779-13 120mm



Noyes
angled, blunt/blunt
L8779-14 120mm

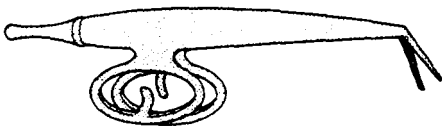

Sinclair
7mm blade
L8782-55 55mm

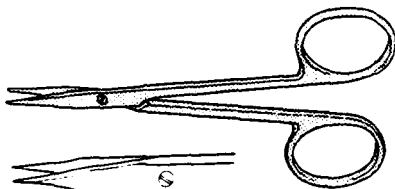

Stevens
straight, sharp
L8784-11 115mm

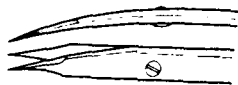

curved, sharp
L8785-11 115mm



straight, blunt
L8786-11 115mm



curved, blunt
L8787-11 115mm

Eye Scissors

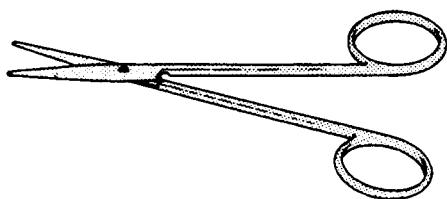
**Strabismus**

straight, blunt
L8790-09 90mm
L8790-11 110mm

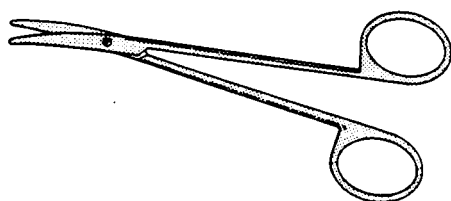
**Strabismus**

curved, blunt
L8791-09 90mm
L8791-11 110mm

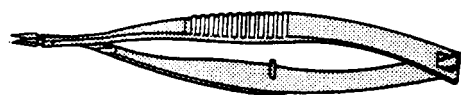
**Vannas**

straight, sharp
L8795-80 80mm

**Vannas**

curved, sharp
L8796-80 80mm

**Vannas**

angled, sharp
L8797-80 80mm

**Vannas**

angled upwards, sharp
L8798-80 80mm

**Wecker**

angled to side, sharp/sharp
L8805-11 110mm

**Wecker**

angled to side, blunt/sharp
L8805-12 110mm

**Wecker**

angled to side, blunt/blunt
L8805-13 110mm

Eye Scissors



Westcott
straight, sharp
L8810-11 115mm

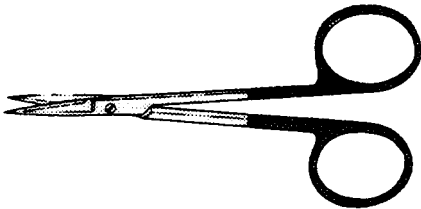

Westcott
curved, sharp
L8811-11 115mm

Eye Scissors,
Tungsten Carbide

Iris
straight, sharp
L8815-11 115mm



Iris
curved, sharp
L8816-11 115mm

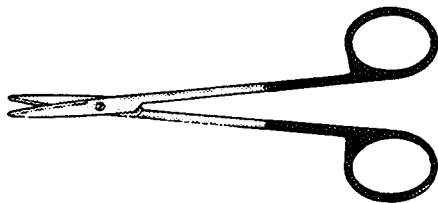

Strabismus
straight, blunt
L8820-11 110mm

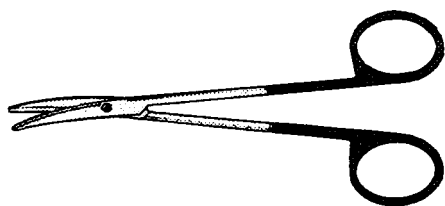

Strabismus
curved, blunt
L8821-11 110mm

Eye Spatulas

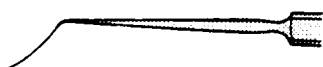

Castroviejo
L8825-10 10mm
L8825-15 15mm

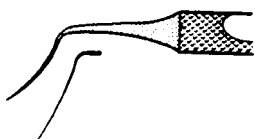

Castroviejo
L8826-90 90mm, fine form

Eye Spatulas

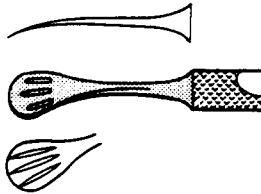
**Castroviejo**

L8827-95 35mm, flat form

Eye Specula

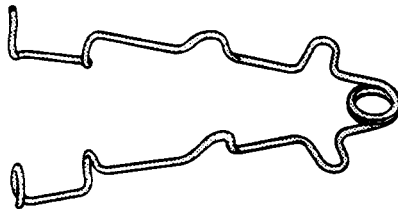
**Bowman**

L8835-70 70mm

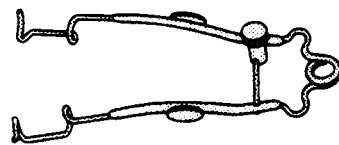
**Graefe**

for adults

L8840-90 90mm

for children

L8840-60 60mm

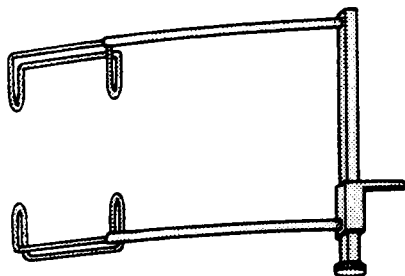
**Murdock**

L8850-50 50mm

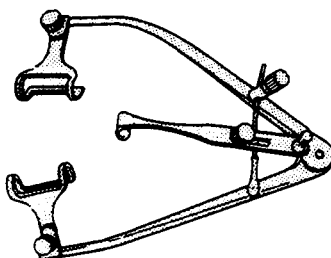
**Park**

L8850-80 80mm

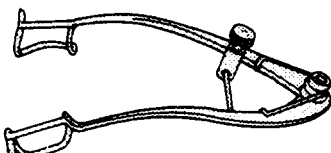
**Weiss**

for adults

L8855-90 90mm

for children

L8855-70 70mm

Foreign Body Instruments



Eye
double ended
L8860-01 needle and spud combined



Eye
double ended
L8861-01 probe and curette combined

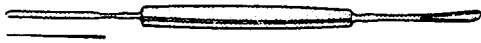

Eye
double ended
L8862-01 repositor and curette combined

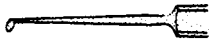

La Force
L8865-01 golf club



Walton
L8870-01 gouge

Keratomes

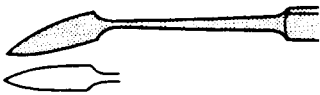

Castroviejo
L8875-04 413mm

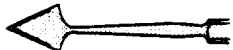

Jaeger
straight
L8880-01 size 1
L8880-02 size 2
L8880-03 size 3
L8880-04 size 4

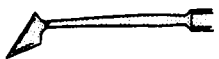
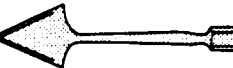
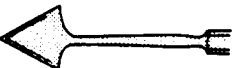

Jaeger
angled
L8881-01 size 1
L8801-02 size 2
L8801-03 size 3
L8801-04 size 4

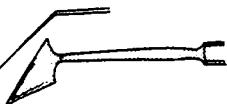
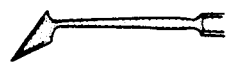
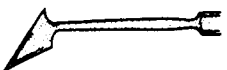

Keratomes

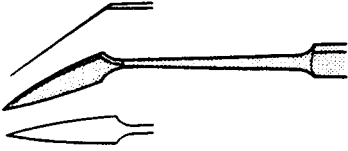

Wecker
 angled
 L8885-01 size 1
 L8885-02 size 2
 Lachrymal Dilators



Wilder
 L8890-01 size 1



Wilder
 L8890-02 size 2



Wilder
 L8890-03 size 3
 page 387

Lens Expressors



Berens
 L8895-01 curved



Elschnig Spoon
 L8900-01 left

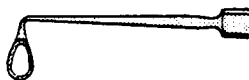

Elschnig Spoon
 L8900-02 right



Snellen Loop
 L8905-01 vectis

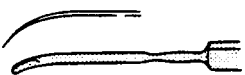

Weber
 L8910-01 curved



Weber Loop
 L8913-01 large

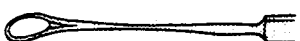

Weber Loop
 L8913-02 small



Ligature Needles

**Woodruff**

curved to left
L8917-13 130mm

**Woodruff**

curved to right
L8917-14 130mm

Needleholders

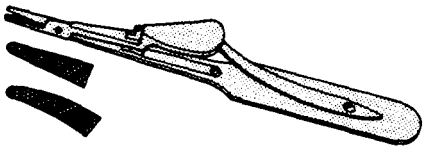
**Arruga**

straight
L8920-14 140mm
Curved
L8921-14 140mm

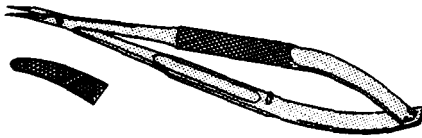
**Barraquer**

Curved
L8925-14 140mm

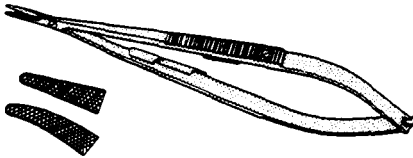
**Castroviejo**

with locking catch, straight
L8930-09 90mm
L8930-14 140mm
L8930-18 180mm
L8930-21 215mm
with locking catch, curved
L8931-09 90mm
L8931-14 140mm

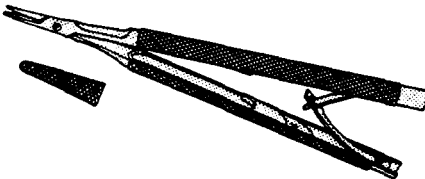
**Castroviejo**

straight
L8935-13 130mm

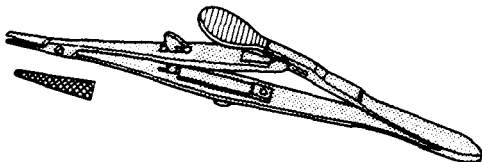
**Kalt**

with locking catch, straight
L8937-14 140mm

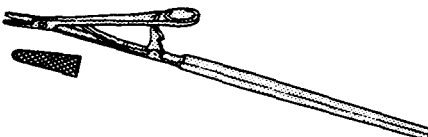
**Stevens**

with locking catch, straight
L8940-13 130mm
L8940-15 150mm

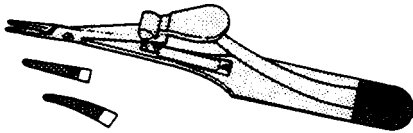
Needleholders,
Tungsten Carbide**Arruga**

straight

L8943-14 140mm

curved

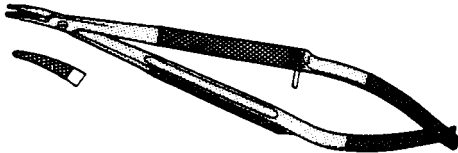
L8944-14 140mm**Barraquer**

curved

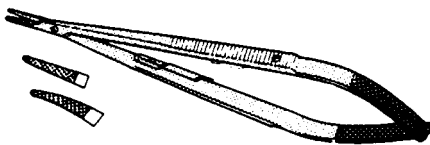
L8947-14 140mm**Castroviejo**

with locking catch, straight

L8950-09 90mm**L8950-14** 140mm**L8950-18** 180mm**L8950-21** 215mm

with locking catch, curved

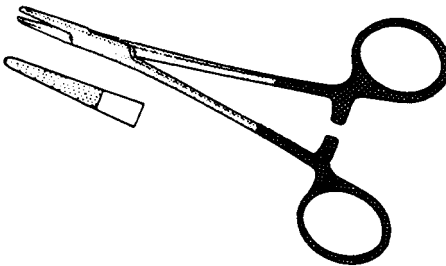
L8951-09 90mm**L8951-14** 140mm**Converse**

straight

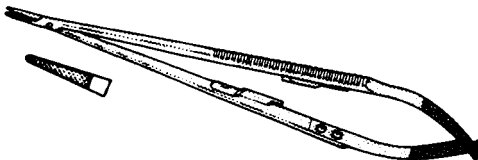
L8955-12 125mm**Jacobsen**

with locking catch

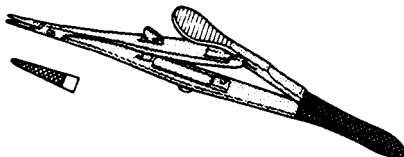
L8958-18 180mm**L8958-21** 210mm**Kalt**

with locking catch, straight

L8960-14 140mm

Punch Forceps

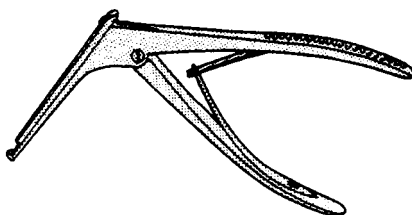
**Kerrison**

upward cutting

L8968-03 3mm bite**L8968-04** 4mm bite**L8968-05** 5mm bite**L8968-06** 6mm bite

Razor Blade Holder

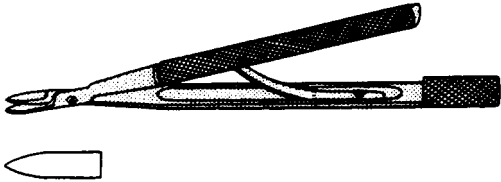
**Castroviejo**

8mm jaw
L8971-13 130mm

Scleral Rings

**Flieringa**

L8975-14 14mm
L8975-16 16mm
L8975-18 18mm
L8975-21 20mm
L8975-22 22mm
L8975-24 24mm

Scleral Markers

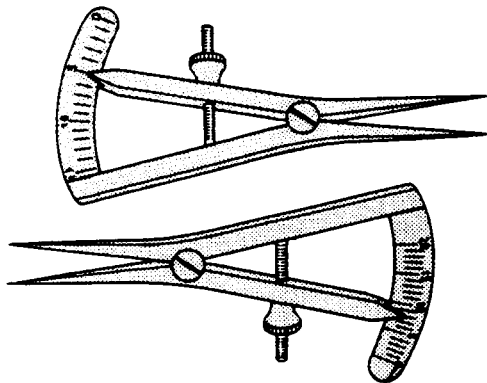
**Castroviejo**

straight
L8980-15 15mm range
L8980-20 20mm range

Tonometer

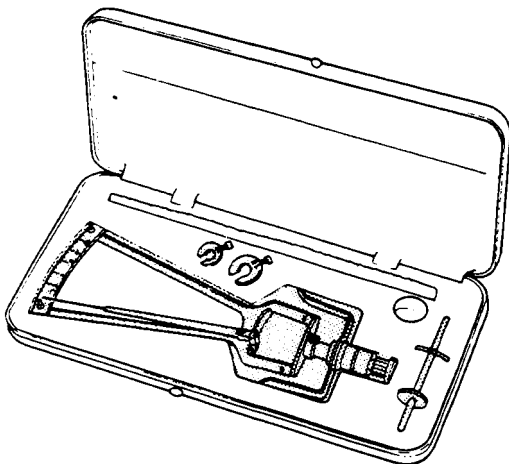
**Schiottz**

with certification
L8985-01 complete

Trepines

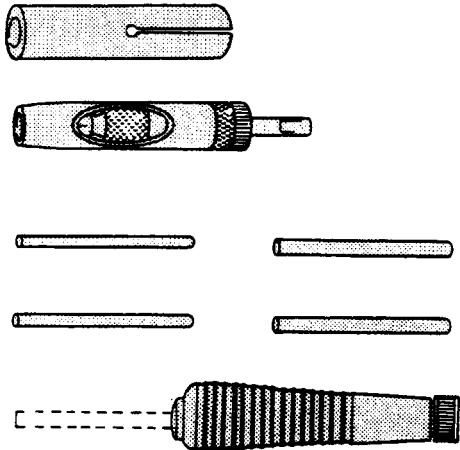
**Castroviejo**

L8990-03 5.0mm
L8990-04 5.5mm
L8990-05 6.0mm
L8990-06 6.5mm
L8990-07 7.0mm
L8990-08 8.0mm
L8990-09 9.0mm
L8990-10 10.0mm
L8990-11 11.0mm

Elliot

L8995-15 1.5mm
L8995-20 2.0mm
L8995-25 complete with 2 blades