

“GO 2” USER MANUAL



Contents

General Operation	3
Power Up	4
Keyboard functions	4
Manual Positioning	5
Controlled Positioning	5
Cut's Counter	6
Programs	
Entering Programs	8
Editing Programs	10
Clearing Programs	11
Running Programs	12
Operators Menu's	
Recalibrate	13
Set Calibrate Position	13
View Total Cuts	14
Display Cuts	14
False Clamp	14
Change Precision	14
Appendix A – Connections & inverter settings (E520 + ATV11)	15
Appendix B – Messages and Actions	21
Appendix C – Troubleshooting	22
Appendix D – Specifications	25
Appendix E – Dimensions	26
Menu Structure	
Operator menu	27
Supervisor menu	28
Engineer menu	30
Installation	
Installation	31
Installation Tips	35
Functions in Brief	37
Service & Support	38

General Description

The IC1600 “GO 2” unit is a multifunction position control system that has been designed for use on any backgauge or gauge assembly that can be fitted with a rotary encoder and is capable of being driven by a motor, typically a leadscrew type assembly.

The installation and Setup has been made easy by utilising screw terminal connectors and RJ45 plugs and sockets, the standard unit can be software configured to work with a wide range of control types, AC Inverter, DC Drives and 2 speed motor via contactors.

The menu structures allow each unit to be Setup to customers specific requirements or machine requirements these include acceleration and deceleration times, minimum and maximum speed, units displayed etc.

The “GO 2” unit has a wipe clean membrane style keypad with tactile feel with confidence beep for each key press and is housed in a rugged custom extruded case, the display is a large format 2 x 20 backlit LCD module with excellent contrast and a wide viewing angle thus allowing mounting of the “GO 2” unit above or below the operators eye line.

Support is given for a wide range of Encoders unlike other systems the “GO 2” uses the actual number of Pulses Per Rev (PPR) and the Pitch to obtain its accuracy and not a pre-scaler, the “GO 2” unit also caters for a wide range of power supplies to enable quick and easy replacement of existing displays or faulty controllers.

The “GO 2” unit has been designed using some of the latest proven technology combined with surface mount components offers a package that is flexible, reliable and cost effective, the firmware is fully upgradeable at any time by simply plugging a programmer in and downloading the latest version of code should the need arise, no chips to remove, thus maintaining the overall system integrity.

GENERAL OPERATION

Power up

At switch on the “GO 2” unit will run through a self test procedure, this is to ensure that any programs or configuration data that is held in non volatile memory is intact and ready for use, during this sequence of self testing information about the unit will be displayed, this includes the software version and date, and manufactures information.



** LOADING CONFIG **
Bank : 0 OK

After the configuration has been loaded the firmware version is displayed

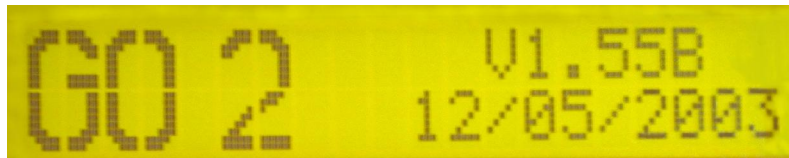

GO 2 V1.55B
12/05/2003

On completion of the self-test the “GO 2” unit will prompt the operator to ensure that the backgauge is clear and press GO (assuming it is safe to do so)

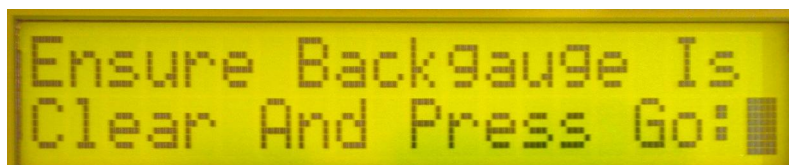

Ensure Backgauge Is
Clear And Press Go: []

The backgauge will now move in slow speed towards the rear of the machine and stop at the calibrate point then move forward to remove any backlash from the system

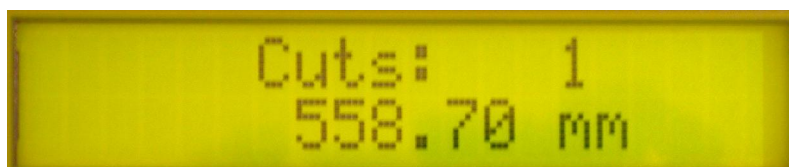

Cuts: 1
558.70 mm

On completion the current position will be displayed (with cuts if enabled)

Keyboard

The keyboard is a standard format tactile membrane with key press confidence beep's to advise the used on each key press, it is split into 2 areas "function buttons" and "numeric input"

Function buttons

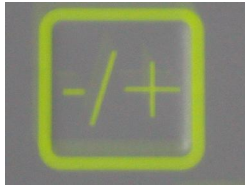

This button allows the user to enter an offset from the current position, for example the current position is 573.5 mm the next cut is 56 mm less (517.5) instead of calculating the required position use offset, press +/- – enter 56 and press GO.



The unit button selects the unit of measurement mm, cm inches and so on it also allows the user to access the Operator Menu, to enter the Operators menu press and hold the unit button until the display reads "Operator Menu".



The Del (Delete) button is used to perform 2 functions firstly it allows the user to delete / remove any incorrect numeric entry and secondly it acts as a back / exit button during program entry and within the menu structure.

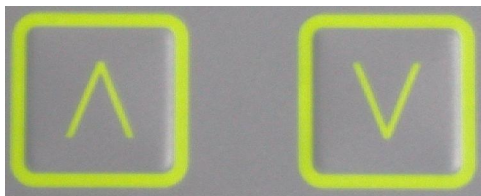

The "^" and "v" buttons are used to manually move the backgauge, the first 3 seconds is a slow speed move or nudge after 3 seconds the backgauge will accelerate to full speed, they are also used as scroll buttons in menu's



The GO button has 2 functions, it acts as an enter button to accept an input or dimension e.g. 200 GO will position to 200, the second function of the GO button is to enter program mode. To enter program mode press and hold until the display shows the program screen see page 8

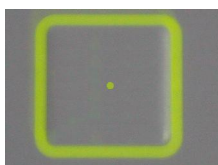

The Decimal Point button has 2 functions the first and primary function is to all entry of fractions if units i.e. 0.5 mm it's secondary function if pressed and held will produce a pushout Movement then return to the previous position

Manual Positioning

Manual positioning is the most basic move, simply press the \wedge to move the backgauge backwards and the \vee to move the backgauge forwards when the nudge buttons are first pressed the backgauge will move in slow speed if held for over 3 seconds the backgauge will accelerate to full speed, useful if you need to move several hundred millimetres

Controlled Positioning

Controlled Positioning is a backgauge movement to a pre determined or absolute position, say 500 mm, to move to a pre determined or absolute position simply enter the required dimension (500) and press GO, the backgauge will now re position to 500 units, the operating units are set by pressing the units button, any backgauge position or move is displayed in current units e.g.

If the display is in millimetres (mm) if you press 500 then GO the backgauge will position to 500mm, if the displayed unit is Inches and you enter 500 then GO the unit would position to 500 inches (machine allowing)

Automatic Positioning

Automatic Positioning is a backgauge movement to a predetermined or absolute position by way of program, the program will contain a number of cuts and positions as the cuts and positions are achieved the backgauge will automatically step onto the next position within the program.

The "GO 2" unit is capable of storing 9 programs with 25 steps per program, the programs are stored in non-volatile memory so that they are retained after power down and restart.

See Page 8 for information on program entry and edit.

Cuts Counter

The “GO 2” unit contains 2 cuts counters, one counter stores the number of cuts at the current position, the other cuts counter stores the total number of cuts since the “GO 2” unit was installed, Total cuts can be used to determine the number of cuts that a knife has performed before each knife change thus giving an indication of when the next knife change may be due or indicating which type of knife is best suited to the material being cut.

The total cuts counter can also be used to obtain usage or machine throughput figures so that work can be allocated to specific machines as required and to aid in work distribution.

Resetting Cuts

If for any reason the Cuts displayed needs to be reset to 0, press the zero button followed by GO

Programs

Program entry

To enter program mode press and hold the GO button, after approximately 3 seconds the “GO 2” display should read

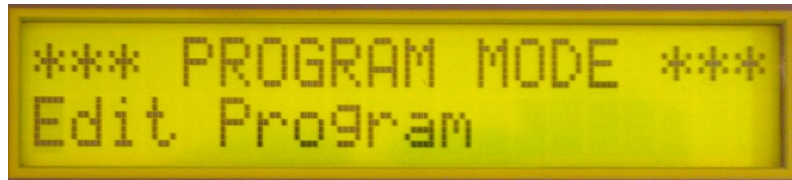

Use “^” or “v” if the display is not as above then Press GO

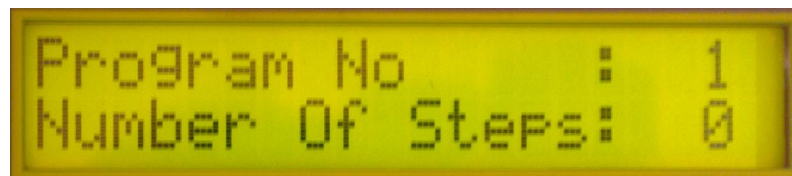

Use “^” or “v” to select the “Program No” to create, in this case it’s No 1, then press GO



The flashing cursor indicates the area in use, in the above case the Step number, Press GO.

NOTE

When you have entered several steps “^” or “v” will allow you to scroll through the step’s within your program should you require.

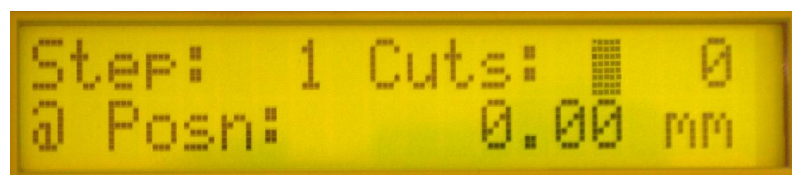

The flashing cursor is now prompting you to enter the number of Cut’s required, once the required number has been typed press GO



The flashing cursor will now be prompting you to enter the position that you require, as with cut's type the required position then press GO

You have now entered the first step in your program, the flashing cursor will now return to the Step area, use the “^” or “v” buttons to advance the step number and repeat the above procedure until the full program is entered then press DEL to save and exit from the program. The display will return to: -

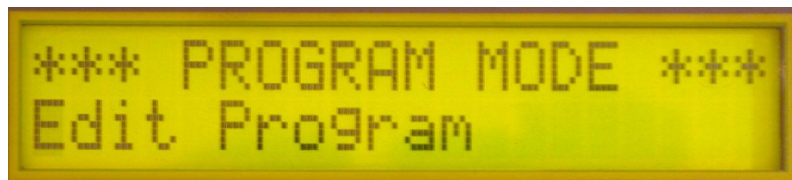

If you need to enter another program or review the program just entered press GO if you want to exit and go back to you running screen press DEL

If you require a pushout within a program you must enter it as a step but ensure that the cut's are left at zero, when the backgauge reaches position it will stop for a fraction of a second then move onto the next step within the program and wait for the required number of cuts.

Program Editing

Editing a program is very much the same as program entry press and hold the GO button until the screen is as below

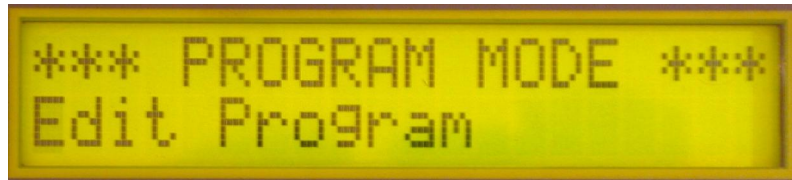

Press GO

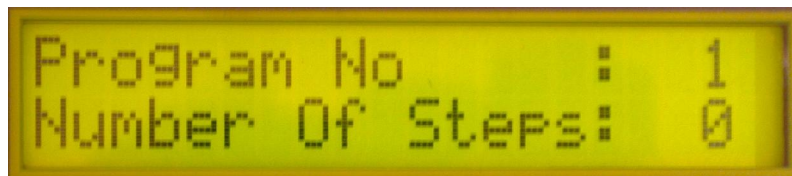

Use “^” or “v” to select the program to edit and press GO

The screen format is exactly the same as program entry, use the GO button to save and move the flashing cursor to the next area to edit, type the new cuts or position and press GO, once you have completed the changes press DEL twice to save and exit

Clearing Programs

To clear programs press and hold the GO button until the display is as below

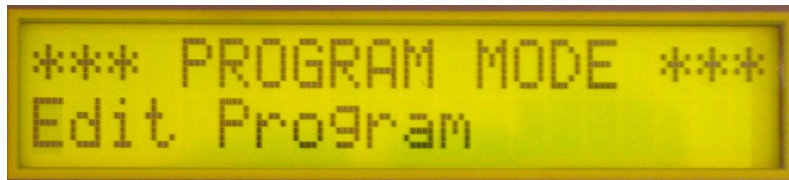

Press “^” or “√”

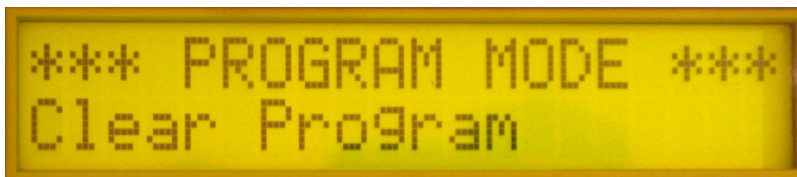

Press GO



Use the “^” or “√” to select the program number to clear then press GO



When the program has been cleared to display will revert to

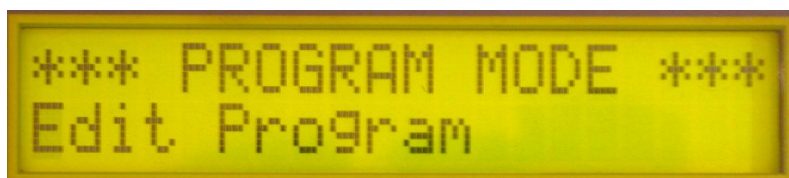

If required you may enter a program, we have assumed that if you delete a program that the next logical step is to enter a program to replace the one deleted, press DEL if you want to return to the normal run mode or GO to create the new program

RUNNING PROGRAMS

Running programs is simple and straightforward, to run program 2 for example press and hold the number 2 until the display reads

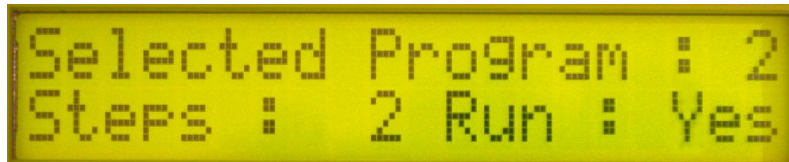

The display now shows that you have opted to run program 2 and that it contains 2 steps, to run the program press GO; the backgauge will now move to its first position and wait for the programmed number of cuts.

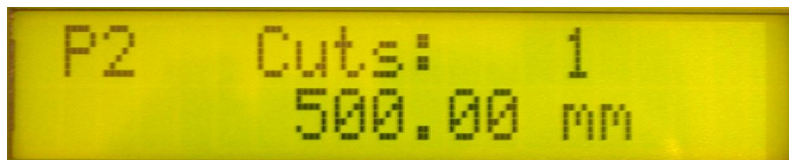

The P2 indicates that you are running program 2, to abort the program press ANY numeric key (0 through 9)

When running a program the Step number will be displayed below the program number (not illustrated above)

Single Step

If for any reason you need step through a program use the GO button once the program is running, this will allow you to break off from one job and go back to it as and when.

OPERATOR MENU

The operator menu contains several functions that may be needed once the unit has been installed, to gain access to the operators menu press and hold the units button after 3 seconds the top line of the display will read “operator menu”

To scroll through the menu use the “^” or “v” buttons until you see the appropriate menu then press GO to enter or execute the command. To Exit from any menu use the DEL button.



Recalibrate

Recalibrate will reset the backgauge to it's correct position as at switch on, if for any reason the Backgauge is incorrect after a recalibrate use “Set Calibrate Position” to correct the error. To recalibrate press GO from operator menu / recalibrate you will then be prompted to ensure backgauge is clear, if it's safe to move the backgauge press GO, the backgauge will now recalibrate itself.

Set Calibrate Position (Press v x 1)

Set Calibrate Position will correct any error between the displayed position and actual backgauge position, to use this function you will need either a good ruler or if possible Vernier Calipers, when Set Calibrate Position is entered you will be prompted

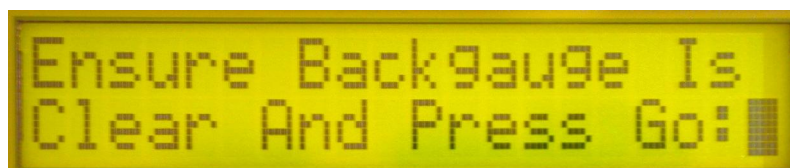

Press GO, this moves the backgauge onto the calibrate switch

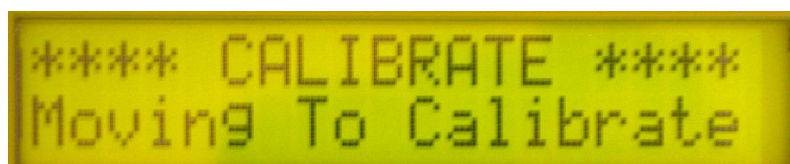

Once the backgauge has reached the calibrate switch it will stop and prompt



At this point you must move the backgauge forward perform a cut and measure the material just cut, enter that dimension and press GO to complete the operation

View Total Cuts (Press √ x 2)

This option will allow you to View the total cuts made to date since the installation of the unit

Display Cuts (Press √ x 3)

Allows the “Cuts” to be displayed, if the “Cuts” display is not required simply select “NO” when prompted

False Clamp (Press √ x 4)

This option allows the use of a false clamp, if the “False Clamp” is fitted the minimum position is changed to ensure that the backgauge will not hit the false clamp when positioning

Change Precision (Press √ x 5)

Allows the number of places after the decimal point to be selected, the defaults should be set at the time of installation

Pressing DEL from the operator’s menu will return to the operating mode.

APPENDIX A - Connections

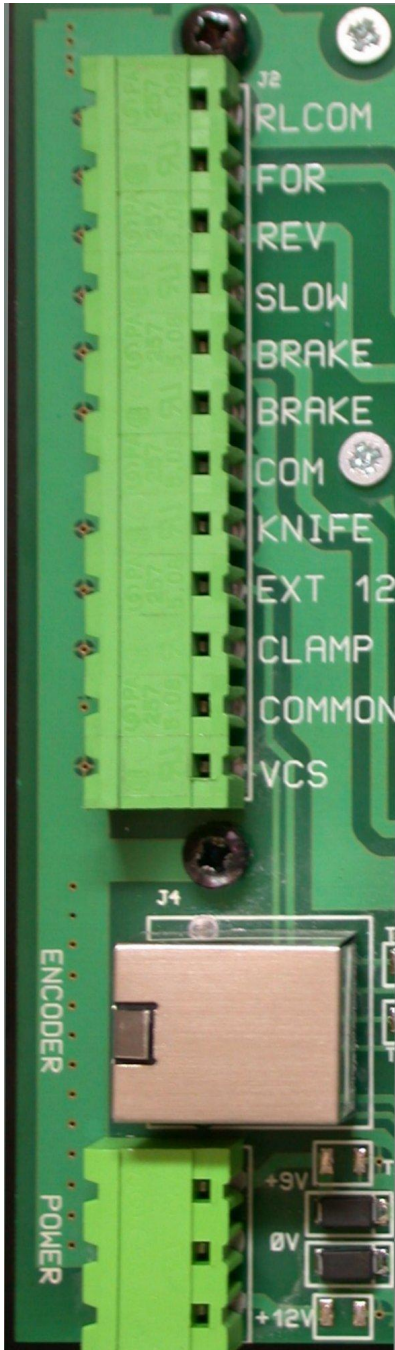

Common connection point for forward, reverse and slow

Forward relay

Reverse relay

Slow relay

Brake relay to slave relay or contactors

Common connection for Knife & clamp switches

Knife switch input

Supply for Knife & Clamp switches (if proximity type)

Clamp input

Voltage Command Signal Common

Voltage Command Signal (analogue output)

Encoder connection Via RJ45 cable and inter connection box (Page 16)

+ 9v DC Input

Common or 0v Input

+ 15v DC input

Fit link for single supply
Operation at 15v DC

Note

Common or 0v input can if required be connected to system Earth, the “GO 2” unit is floating because of power supply isolation in certain environments this is not desirable and so an Earth reference may be added if required.

Connections (Continued)

The Encoder and Calibrate switch are terminated within the interconnection unit shown below, all the screw terminals are clearly marked and should be connected as pictured below,



Encoder + Calibrate switch connections

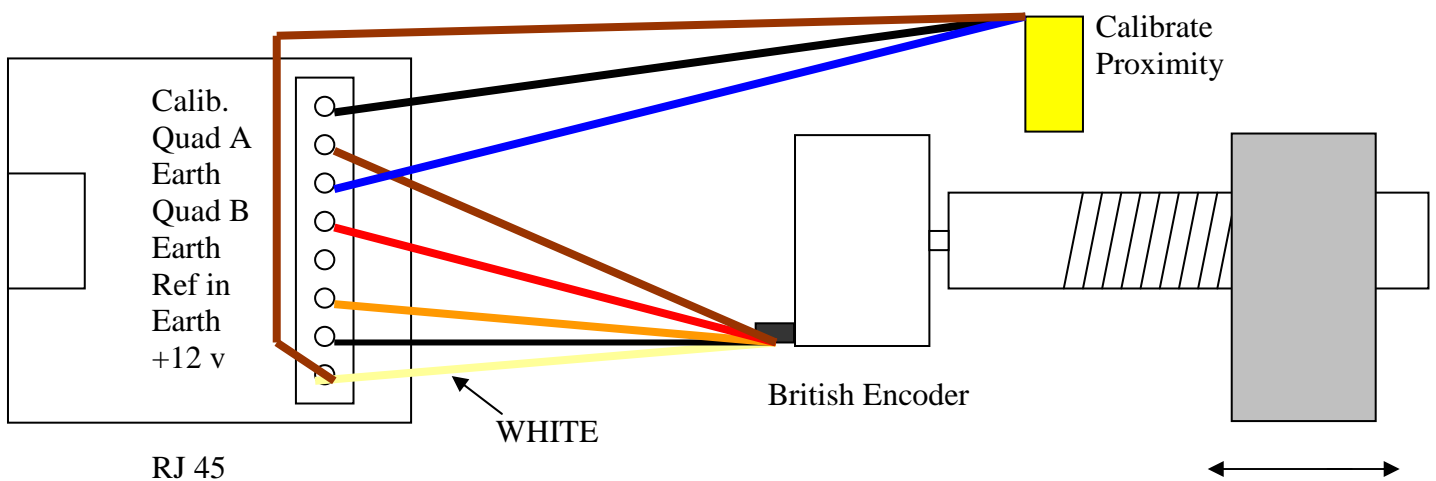

Note

The Earth terminal is **NOT** a true Earth it is the system Earth only

Connections (Continued)

The drive connections will vary for installations depending on the existing control panel or if a complete panel is being replaced we have included interconnection information for a Mitsubishi E520 inverter for guidance as it can be supplied as part of the complete kit if required

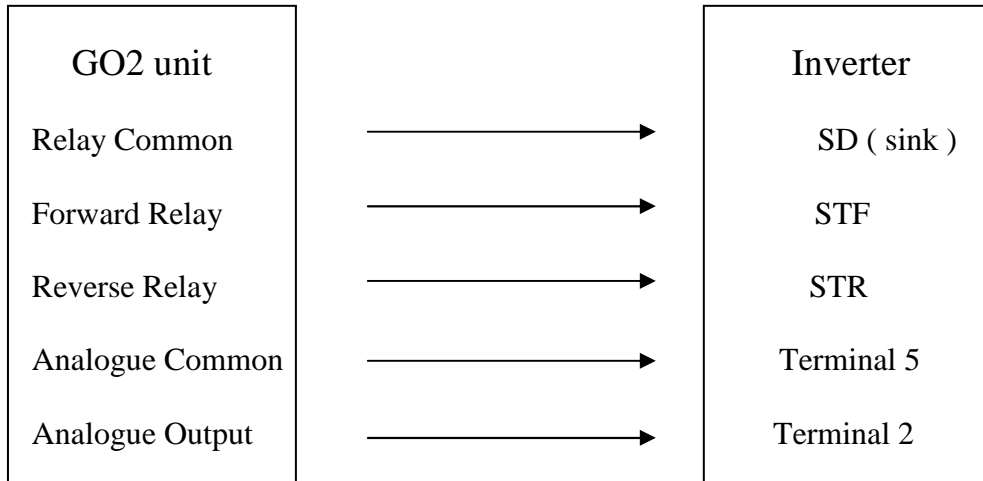

In order to use the SD terminal ensure that the selection link is set to SINK, if the link is in the SOURCE position the PC terminal may be used

Motor / Brake Connections

If the motor has been supplied pre wired as part of the kit it will be wired as detailed below.

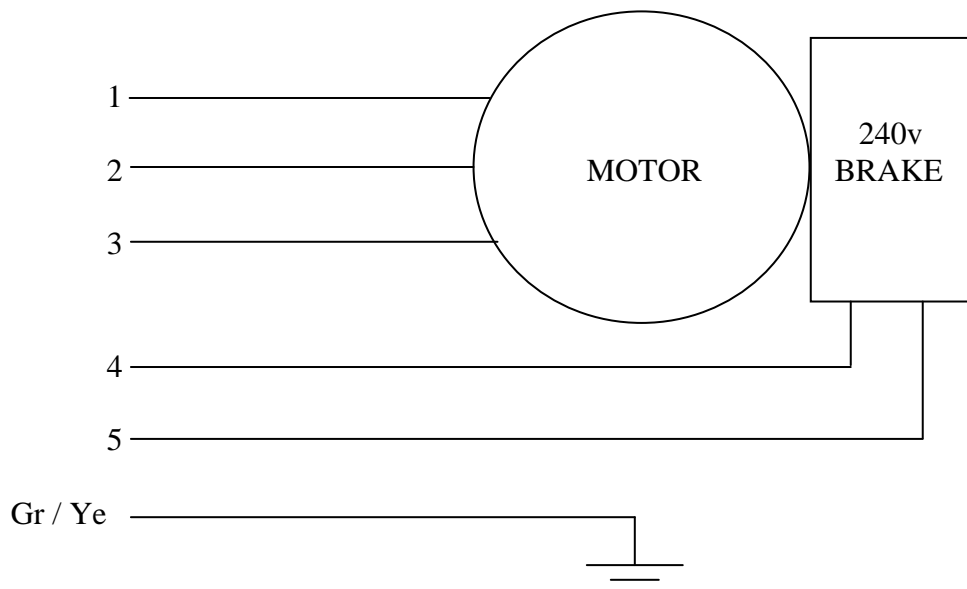

E520 Inverter Settings

If the inverter has been supplied as part of the GO2 kit I will have been programmed as follows.

PR 0	TORQUE BOOST	15 %
PR 1	MAX FREQUENCY	55HZ
PR 2	MIN FREQUENCY	0 HZ
PR 3	BASE FREQUENCY	55HZ
PR 7	ACCELERATION	0
PR 8	DECELERATION	0
PR 9	RATED MOTOR CURRENT	3.4 A
PR 71	APPLIED MOTOR	106
PR 72	PWM FREQUENCY	6
PR 73	VOLTAGE IN SELECTION	1
PR 80	MOTOR CAPACITY	0.75 Kw
PR 83	MOTOR VOLTAGE	230 V
PR 96	TUNING	0
PR 156	STALL PREVENTION	2

ALTIVAR ATV11

Connections for the Altivar ATV11 inverter are as follows

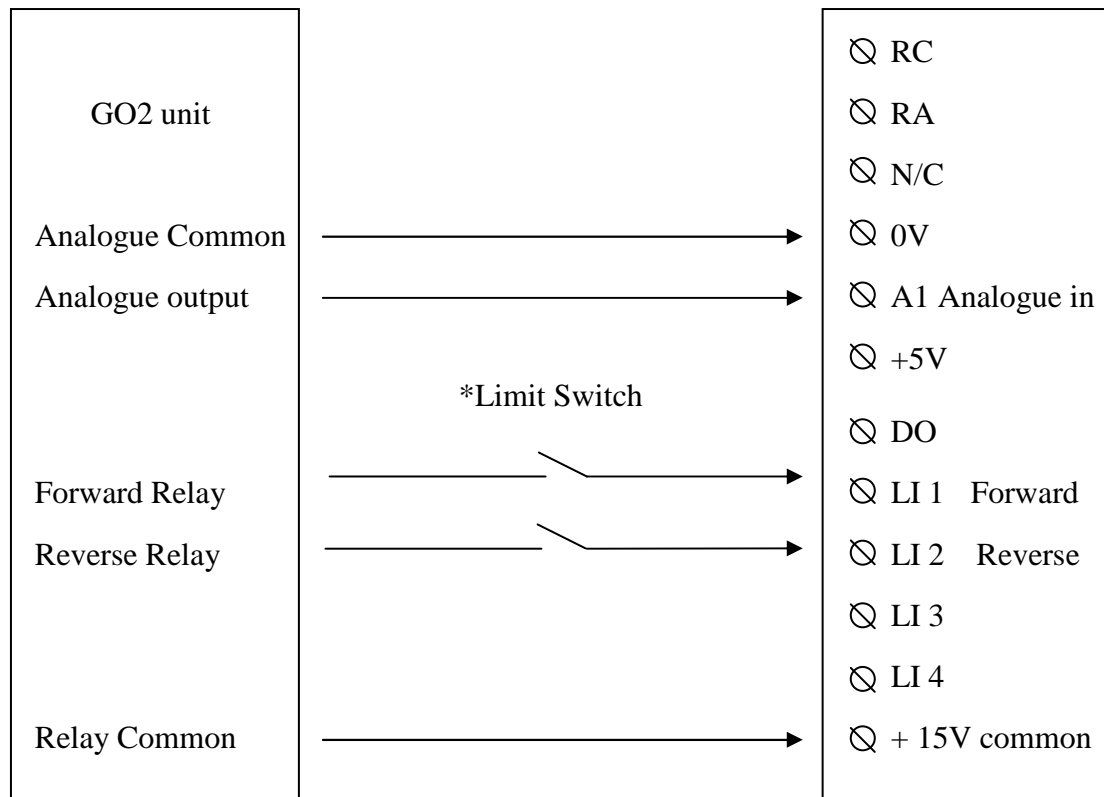

*Limit switches are not necessary as the GO2 unit has software limits, but may be fitted for a true mechanical limit

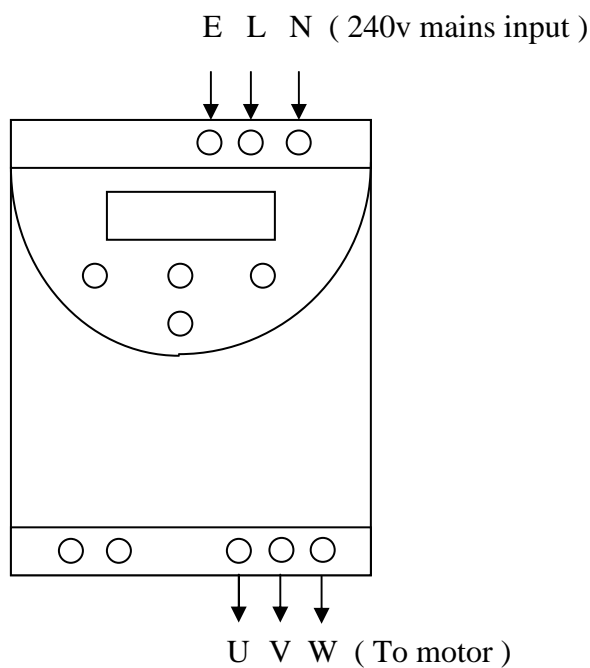

ATV11 Inverter Settings

If the inverter has been supplied as part of the GO2 Kit it will have been programmed as follows.

ACC	Acceleration	0.1s
DEC	Deceleration	0.1s
HSP	High Speed	50 Hz
UNS	Motor Voltage	230v
FRS	Frequency	50 Hz
STA	Loop Stability	5 %
FLG	Loop Gain	70 %
UFR	IR Compensation	200
NSL	Motor Slip	0 %
SLP	Slip Compensation	0 %
COS	Nominal Cosine	0.77
TCC	Control Type	2C
RRS	Reverse	L12
BRA	Deceleration Adaptation	NO
BFR	Motor Frequency	50 Hz

All other settings are as factory default, these settings should be used as a starting point and should suite most installations.

For detailed information on the inverter settings please refer to the Altivar 11 manual as supplied with the inverter.

APPENDIX B - Messages and Actions

<u>Message</u>	<u>Action</u>
Ensure Backgauge is Clear and press GO	If it is safe to move the backgauge press the GO button the backgauge will Now move to a pre determined position
ERROR NOT INSTALLED	This message will be displayed if either the unit has not been Setup or if the configuration has become corrupt you must go through the install procedure
ERROR M/C STALLED	The backgauge has not moved or the encoder has failed; check that the backgauge is free to move and that any couplings are tight also check the Stall Samples value in the supervisor menu (if installing)
ERROR Knife Error	An attempt was made to move forward whilst the Knife was down; check the knife position of the Knife is at TOS check the switch
ERROR Clamp Error	An attempt was made to move forward whilst the Clamp was down; check the position of the Clamp also check the Clamp switch
Range Error	An attempt was made to enter a dimension that is less or greater than the machine limits or incorrect units e.g. 50 inches instead of 50 mm

APPENDIX C – Troubleshooting

<u>Problem</u>	<u>Reason & Action</u>
Display illuminated and the Beeper sounds continuously	The “GO 2” unit has not reset at switch on remove the power for 10 seconds then switch back on
I enter a dimension but the backgauge does not move.	The dimension entered was outside the machine limits, check the current unit’s mode (mm, cm)
Unit will not display inches	Check advanced Config to see if they have been enabled
The backgauge moves forward but the display counts up	The encoder needs reversing in Config, or Quad A and B need swapping over
Cuts are not displayed	Go into operators menu and select display cuts “Yes”
My machine has 950mm of travel but I can only position to 940mm	To ensure that backlash is removed from the backgauge it will position from one direction the overshoot can be adjusted in the supervisor menu but should be ½ the pitch if possible

Troubleshooting (Continued)

Display shows Move encoder through 180 degrees

The encoder reference pulse and Calibrate switch are too close together, turn the encoder and set Calibrate position (page 13)

The backgauge is correct at 900mm but 1mm out at 400mm and 2mm out at 100mm

This would suggest that the PPR Or the Pitch is set incorrectly

The backgauge keeps hunting around Position

Several parameters can cause the Backgauge to hunt around position check the slow speed and tail length also check the mechanics as in 90% of cases they are the problem (clean)

I have got a black square on the left Side of the display

Display Max speed is enabled

K or C are displayed all the time and I cant move the backgauge forward

K of C on the display are advising that the Knife or Clamp are down, to move forward would be unsafe so it is disabled, reverse is allowed for clearance Check ths switches for K & C

F displayed on top line of the display

The "F" indicates that the False Clamp is enabled and will not allow the operator to position to the minimum dimension

I can't position to less than 100mm

Either the machine limit has set incorrectly or the False clamp has been enabled in operator's menu

Troubleshooting (Continued)

“C” is not displayed even when the
Clamp is down

This suggests that the Clamp
option is set to None see Machine
Config Page 25

When I run a program the first position
is ok but the unit will not step on to the
next position unless I press GO

The GO2 is looking for a change
of state on the Knife + Clamp
switch and only seeing one of
them (Knife or Clamp) look for
K or C on the display when cutting
to determine which is missing then
check the Machine Config to
correct.

Also

Check the Knife and Clamp
switches, are they in range and
working

APPENDIX D - Specifications

Supply Voltage	Single supply 15v DC** Twin supply 9v DC and 15v DC **
Supply Current	< 400 ma for unit alone < 600 ma with encoder and sensors
Display	Large format 2 x 20 LCD with LED backlight Metric Resolution mm to 2 dp. Imperial Resolution inches to 3 dp.
Enclosure	Custom extruded section epoxy coated in “Ford Black” with mild steel brackets
Keypad	Membrane keypad with embossed keys and highly tactile Stainless Steel domes and hardwearing overlay
Encoder Input	Opto isolated inputs to suite most encoders NPN, TTL, Push-Pull and Line Drive that will operate At 12V DC and provide A + B + Z
Switch Inputs	3 x Switch inputs suitable for either contact or NPN proximity switches
Outputs	3 x common'd Relay's rated at 1A 250 VAC 1 x Volt free contacts for operation of brake slave relay 1 x Analogue (0 to 10v DC) or (-10v to +10v DC)
Memory	Ferroelectric Ram with retention in excess of 10 years without loss of data (1 billion write cycles)
Hardware	8 Bit microprocessor with 64K Flash, 2K Eeprom 1K Ram with I2c and ISP
Firmware	Fully upgradeable by use of In System Programmer
Manufactures Warranty	12 months, return to base

** See Connections in Appendix A

APPENDIX E - Dimensions

FRONT VIEW

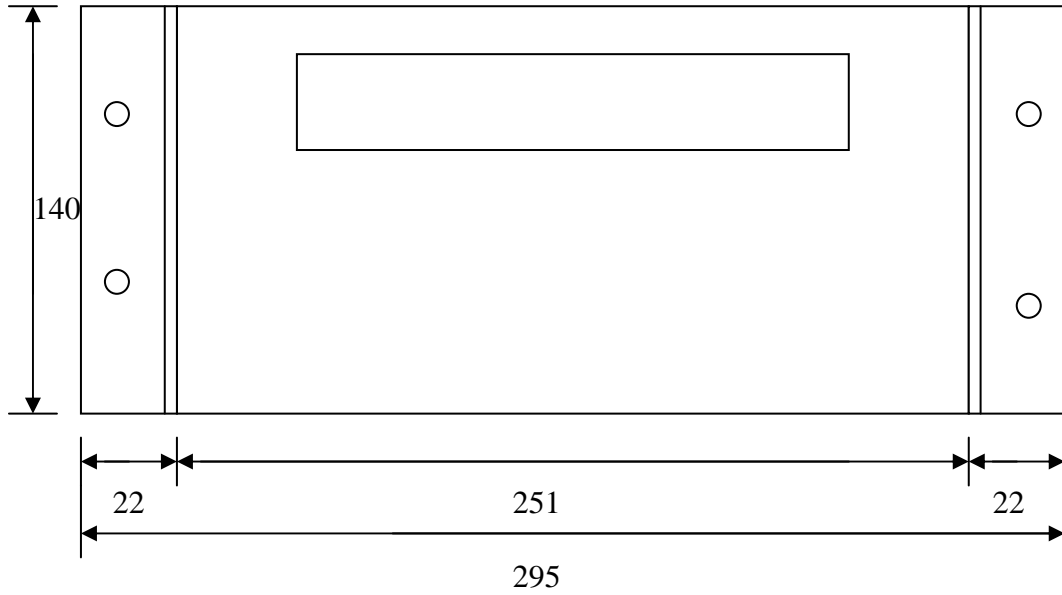

SIDE VIEW

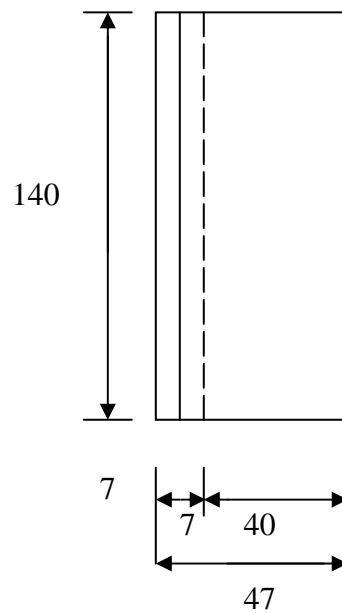

Dimensions in mm

MENU STRUCTURE

The “GO 2” unit contains 3 menu structures: -

- 1) The operator’s menus, used in day-to-day operation
- 2) The Supervisor menus, used to change or correct parameters
- 3) The Engineers menu, used for installation

To access the menu’s press and hold the DEL button until the display changes to “CHOOSE MENU” then use the “^” or “v” to scroll to the required menu and press GO to select and enter.

The Supervisor and Engineer menus are protected by passwords to prevent accidental changes to parameters within the menus; we strongly recommend that you DO NOT change parameters unless you fully understand the implications of your actions.

The Supervisor Password is XXXX and GO to enter

The Engineer Password is XXXX and GO to enter

Once you have entered the Supervisor or Engineer’s menu the v and ^ buttons are used to scroll around once a sub menu is entered use DEL to take you back to a previous item and GO to accept the data displayed and move on to the next item, once the end of the menu has been reached you have the option to save the changes Yes saves No restores the previous contents.

Operator menu

Recalibrate	Resets the backgauge as at power on
Set Calibrate Position	Corrects gauge position if incorrect
View Total Cut’s	Displays total cuts to date
Display Cut’s	Allows cuts to be displayed
False Clamp	Allows use of False Clamp offset
Change Precision	Adjusts No. of decimal places shown

Supervisor Menu (Continued)



Advanced Config.

Reverse Encoder	Yes / No	Reverses Count direction
Encoder P P R	0 – 1000	Pulses Per Rev of the Encoder
Screw Pitch	0 – 25mm	Effective pitch of screw and gearing
Default Units	mm	Powers up into mm
Snap To	Yes / No	Display rounding at position
Snap Tolerance	0 – 99mm	Tolerance of rounding + / -
Display Cuts	Yes / No	Display cuts if required
Enable mm	Yes / No	Allow mm to be displayed
mm Precision	0 – .00	No of decimal places
Enable cm	Yes / No	Allow cm to be displayed
cm Precision	0 – .000	No. of decimal places
Enable Inches	Yes / No	Allow inches to be displayed
Inches Precision	0 – .000	No. of decimal places
Enable 1/inch	Yes / No	Allow Fractal inches to be displayed
1/inch Precision	½ to 1/64	Fractal size minimum
Enable Dual Units	Yes / No	Allow 2 units displayed on 1 screen
Dual Unit 1		Unit to be displayed on top line
Dual Unit 2		Unit to be displayed on bottom line
Enable Pulses	Yes / No	For debug only
Enable Debug	Yes / No	For debug only
Show Speed	Yes / No	Display bar graph of current speed
Show Max Speed	Yes / No	Display peak speed on left of display
Save Changes		

Engineer Menu

Engineer Menu

→ Auto Install

The Auto Install routine guides you through the installation process to allow the GO 2 unit to run, though we recommend fine tuning via the supervisor menu.

→ Check FRAM

Check FRAM performs 2 tests to check the integrity of the Ferroelectric Ram

→ Overrun Mapping

Overrun Mapping breaks the leadscrew up into 2000 divisions or Zones each Zone is then given an overrun value during positioning this allows the leadscrew to be mapped to ensure that positioning remains constant even if the leadscrew is worn and contains tight spots.

If the overrun mapping is disabled a single value is used for the entire leadscrew assembly.

→ Reset Overruns

Resets the entire overrun table, used if repair work has been undertaken that dramatically affects the mechanical properties.

→ Reset Total Cuts

Resets the Total Cut counter to 0000

→ Clear All Programs

Deletes all the programs and resets the program memory

→ Factory Default

Factory Default restores all the factory settings for ALL parameters in ALL menu structures but does not delete the user programs, after a factory default the "GO 2" will prompt "NOT INSTALLED" and will need reinstalling from Auto Install

→ Debounce Input

If proximity inputs are subject to noise and cause false triggering increase the debounce time in multiples of 10ms

INSTALLATION AND SETUP

The installation procedure has been kept simple and logical to allow any competent engineer to install and commission a system in less than a day.

Sensor Installation

Correct installation of the sensors is critical for trouble free operation please take time and care to ensure that the sensors are properly fitted in the best possible place.

Encoder

The encoder must be mounted rigidly and driven by way of belt, chain or flexible coupling and mounted in a position that will provide some protection, the cable should be secured and wherever possible routed away from sources or electrical noise.

The Calibrate Switch

The Calibrate switch must be mounted towards the maximum travel but in such a position that the backgauge or gauging mechanism will never run off the switch see diagram below

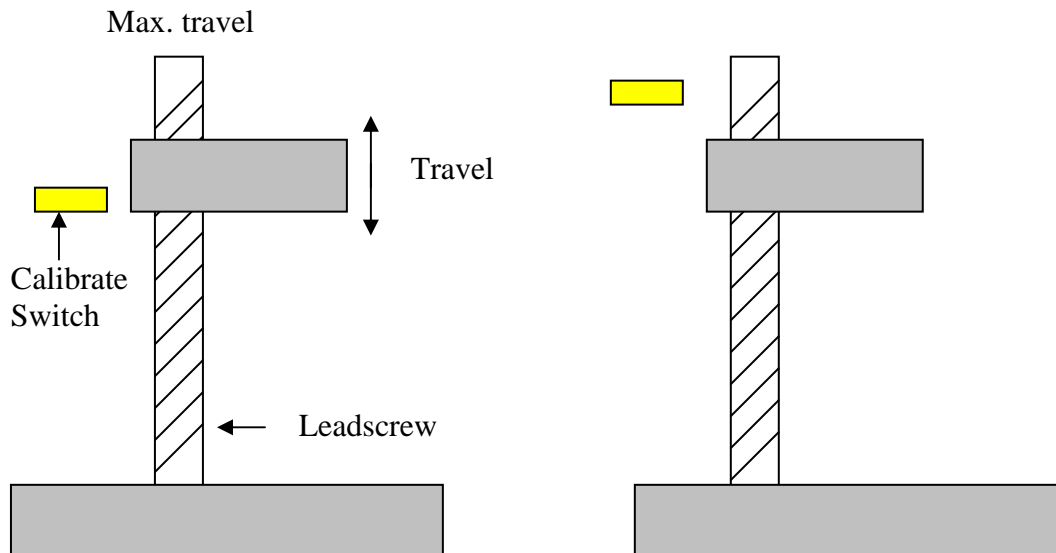

A) WRONG

B) Correct

As can be seen from diagram A) when the backgauge or gauging mechanism reaches its maximum travel it will no longer be on the calibrate switch, this will cause a failure at calibrate. At switch-on the “GO 2” unit will move backwards to find the calibrate switch then come forward one revolution to find a reference pulse from the encoder, in diagram B) the calibrate switch is correctly positioned allowing some overrun but never allowing runoff.

Knife and Clamp Switches (if applicable)

The Knife and Clamp sensors should be fitted so that when the Knife or Clamp begin to move the switch sees the movement, the “GO 2” unit will NOT position in a forward direction if the Knife or Clamp are down or the switch has been seen, this ensures that the material being cut or bent will be stationary and operators hands away from the material.

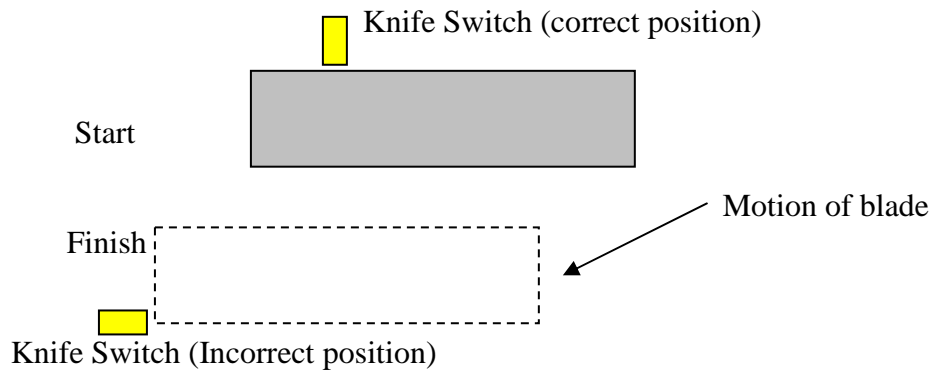

The Knife and Clamp will also act as step change inputs whilst running a program if you do not intend to run programs and do not wish to inhibit forward movement when the Knife or Clamp are down these switches can be left unfitted, though we strongly suggest that they are.

Note

If the Clamp option is set as NONE the position inhibit and step change will occur on Knife only

Once the “GO 2” unit and sensors have been installed, checked and verified power can be applied, the “GO 2” unit will go through a self-test procedure and then prompt, “ERROR NOT INSTALLED” followed by the Engineers mode,

Press GO
Type 1600 then press GO
The display will now be showing “Auto Install”
Press GO

Now simply follow the on screen prompts, and then save at the end

Slow speed detection

During the auto install you will be prompted to enter the slow speed forward and reverse, these are set to a default of 10%, however in certain applications it is possible to run much slower and maintain a constant speed, to automatically detect the slowest speed that the system will drive at enter a value of 0% for the slow speed, the backgauge will then move forward by 5 revolutions to determine the slowest speed forward, then drive backwards through 5 revolutions to determine the slowest speed in reverse and prompt to save the speed detected, as a rule we add a few percent to allow for tight spots or changes in material weight.

If the slow speed is set too low it can cause problems positioning.

Machine Efficiency setting

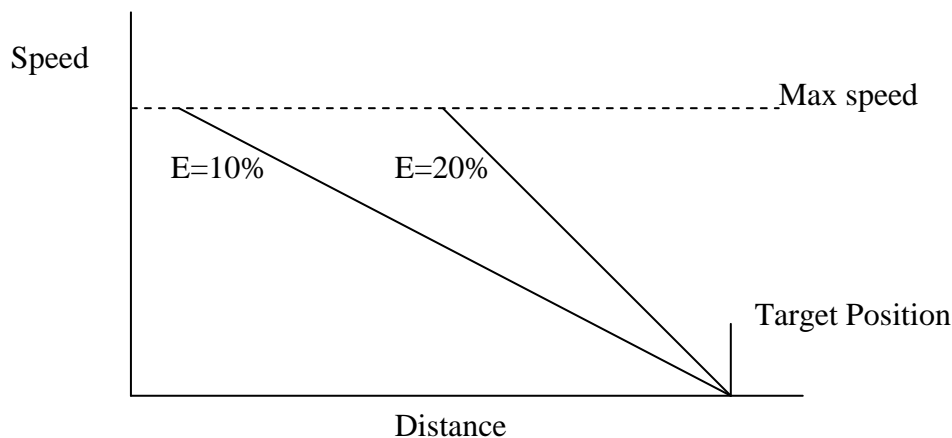

The efficiency setting will effect the speed of positioning quite dramatically, if the backgauge or application has a high inertial load it will take longer to stop than a system with virtually no inertial load, by setting the efficiency to 10%, the default, the stopping time and distance are relatively long and smooth if the efficiency is changed to 20% the deceleration distance will halve as will the time to decelerate,

By adjusting the efficiency the system can be Setup to suite any application regardless of the size or speed and tuned to give the fastest response, if the efficiency is set too high you are in effect creating a vertical deceleration ramp which will lead to excessive strain on all associated components and may effect positioning

D2A Damping

D2A damping is a secondary method of controlling the acceleration and deceleration time, there are 256 steps from 0 which is stationary to 255 full speed, if the damping is set at 10 you have 25 steps for the acceleration or deceleration ramp hence the smaller the damping value the smoother the acceleration and deceleration curves are.

Typically the acceleration damping would be set at a higher value than the deceleration damping thus reducing the cycle time and maintaining positioning.

If during the install procedure you suspect an incorrect value has been saved these can now be corrected from within the Supervisor menu.

If you are 100% sure that all the parameters are correct Press DEL to exit from the menus structure, the “GO 2” unit will now prompt

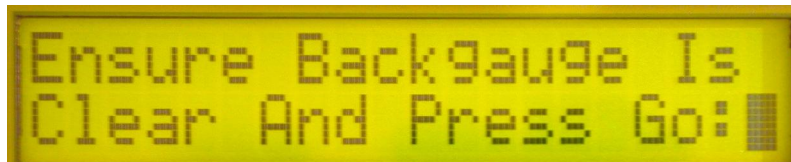

When you have checked that it is safe to move the backgauge press GO, the backgauge will now go through it's calibrate procedure and stop at the back, then return to the operating screen displaying the current position, at this point it is worth checking that the position displayed is correct then move to a mid position on a 1m machine use 500mm, the backgauge may hunt a couple of times until it has calculated its overruns, measure the position then move further forward to say 50mm at this dimension perform a cut or bend to establish the actual size, if the size is incorrect adjust using the “Set Calibrate position” on Page 13 then recheck.

INSTALLATION TIPS

Every installer will undoubtedly have their own preference as to system installation we have provided this section simply to pass on some of our findings whilst installations have been carried out

An understanding of the menu structure is not necessary but will enable you to get the most out of the system and fine tune it to your customers requirements and in most cases far beyond.

- 1) Mount the “GO 2” unit on the machine (drill + Tap 4 x M4 holes)
- 2) Remove the unit and re fit the right hand bracket only on the machine.
The right hand bracket has a 20mm hole for a conduit gland
- 3) Fit the Encoder and Calibrate switch and wire into the small black interconnection unit then route the RJ45 cable up towards the “GO 2” unit.
- 4) Now fit the Knife & Clamp Switches (if required) and the power supply and again route towards the “GO 2” unit
- 5) Slide the cables through the flexible conduit provided RJ45 FIRST
- 6) Terminate the cables as required and finally insert the RJ45, now carefully draw back any excess cable so that the “GO 2” sits in place and press home the gland on the conduit.
- 7) Refit the “GO 2” enclosure and secure to the machine and secure the conduit

You are now ready to Setup your system

INSTALLATION NOTES

FUNCTIONS IN BRIEF (CHEAT SHEET)

“√” OR “^”	MOVES GAUGE FORWARD OR REVERSE
UNIT	CHANGE MM TO CM TO INCHES ALSO PRESS AND HOLD FOR OPERATOR MENU
DEL	DELETE BUTTON AND EXIT PROGRAM
“ . “	DECIMAL POINT OR PUSHOUT (Hold in)
GO	PRESS AND HOLD TO ENTER PROGRAM MODE
XX THEN GO	MOVES TO POSITION XX
“ 0 “	RESET CUTS
+ / -	ALLOWS ENTRY OF OFFSET FROM CURRENT POSITION SAY – 50MM OR + 50MM
RUN PROGRAM	PRESS AND HOLD THE PROGRAM NUMBER (SAY 1) THEN GO
ABORT PROGRAM	PRESS ANY NUMERIC BUTTON

SERVICING

The IC1600 “GO 2” is a microprocessor controlled system which contains two Microprocessors and a wide range of surface mount support components consequently there are **NO USER SERVICEABLE PARTS**

In the unlikely event of a failure you **MUST** contact your system installer Or SP Electronics

Installer details

Name

Address.....

.....

.....

Contact

Tel

Fax.....

SP Electronics

TEL +44 (0) 870 321 5117

FAX +44 (0) 870 321 5118

E-MAIL sp@sp-electronics.co.uk

The support line is available to all installers and customers 365 days a year, except for exceptional circumstances, if you have any questions re the installation or Setup of your “GO 2” please contact us

SP Electronics (TARLETON) cannot be held liable for any damage, loss or injuries as a result of improper or incorrect use of our equipment. Nor can we be held liable for any damage, loss or injury as a result of poor or improper installation carried out by a third party or as a result of equipment failure. If you have any reservations you should contact us in writing stating the nature of your concern this will enable us to look into it more deeply.

Every effort has been made to ensure correct operation of this equipment if you as a customer find anything that you consider to be incorrect operation please advise us we can then endeavour to correct it. Due to ongoing development we reserve the right to change specification without prior notice