

Elite Precast Concrete Duo™ interlocking blocks

Duo BL1 (BL-600)

600mm x 600mm x 450mm
375kg
Artic Full Load 76 no.
Crane Offload 61 no.
Lifting Clutch 2.5t

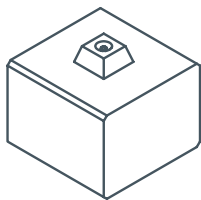

Duo BL2 (BL-1200)

1200mm x 600mm x 450mm
750kg
Artic Full Load 38 no.
Crane Offload 30 no.
Lifting Clutch 2.5t

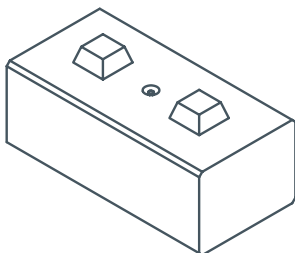

Duo BL3 (BL-1800)

1800mm x 600mm x 450mm
1125kg
Artic Full Load 25 no.
Crane Offload 20 no.
Lifting Clutch 2.5t

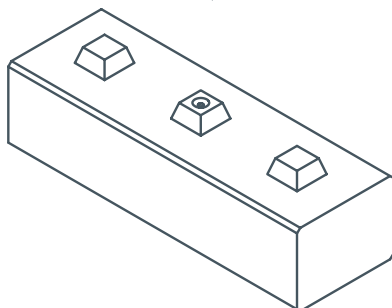

Duo BL1(F) (BLF-600)

600mm x 600mm x 450mm
375kg
Artic Full Load 76 no.
Crane Offload 61 no.
Lifting Clutch 2.5t

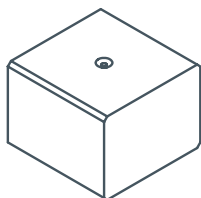

Duo BL2(F) (BLF-1200)

1200mm x 600mm x 450mm
750kg
Artic Full Load 38 no.
Crane Offload 30 no.
Lifting Clutch 2.5t

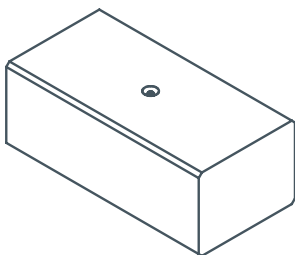

Duo BL3(F) (BLF-1800)

1800mm x 600mm x 450mm
1125kg
Artic Full Load 25 no.
Crane Offload 20 no.
Lifting Clutch 2.5t

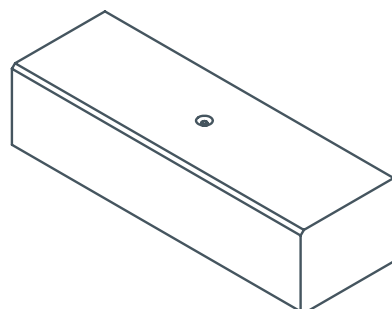

For more information or technical advice, contact 01952 588885
or browse our products on www.eliteprecast.co.uk