

Elite Precast Concrete

Vee™ interlocking blocks sheet 1

Vee B1-610

610mm x 610mm x 610mm
533kg
Artic Full Load 54 no.
Crane Offload 43 no.

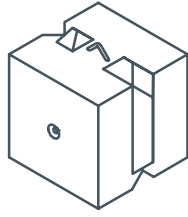

Vee B1-915

915mm x 610mm x 610mm
800kg
Artic Full Load 36 no.
Crane Offload : 28 no.

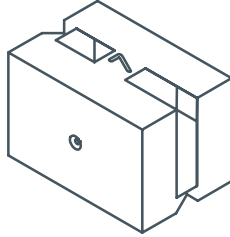

Vee B1-1220

1220mm x 610mm x 610mm
1067kg
Artic Full Load 26 no.
Crane Offload 21 no.

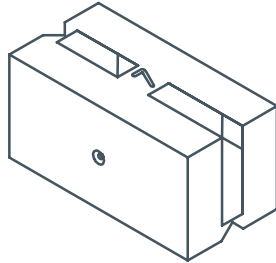

Vee B1-1525

1525mm x 610mm x 610mm
1333kg
Artic Full Load 21 no.
Crane Offload 17 no.

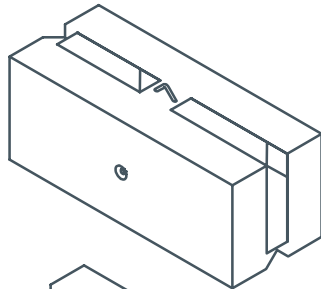

Vee B1-1830

1830mm x 610mm x 610mm
1600kg
Artic Full Load 18 no.
Crane Offload 14 no.

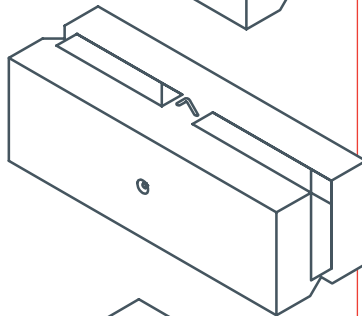

Vee B2-610

610mm x 610 mm x 610mm
533kg
Artic Full Load 54 no.
Crane Offload 43 no.

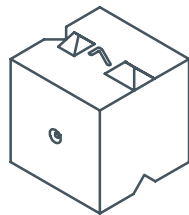

Vee B2-915

915mm x 610mm x 610mm
800kg
Artic Full Load 36 no.
Crane Offload 28 no.

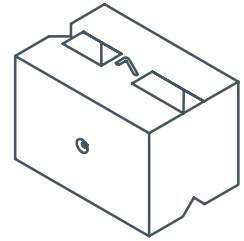

Vee B2-1220

1220mm x 610mm x 610mm
1067kg
Artic Full Load 26 no.
Crane Offload 21 no.

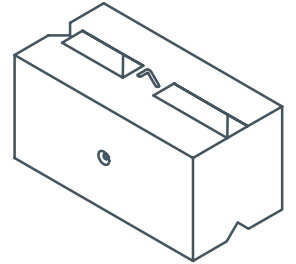

Vee B2-1525

1525mm x 610 mm x 610mm
1333kg
Artic Full Load 21 no.
Crane Offload 17 no.

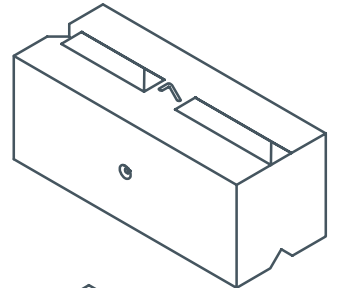

Vee B2-1830

1830mm x 610mm x 610mm
1600kg
Artic Full Load 18 no.
Crane Offload 14 no.

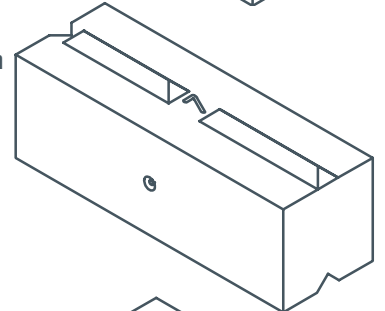

Vee FB-610

610mm x 610mm x 610mm
533kg
Artic Full Load 54 no.
Crane Offload 43 no.

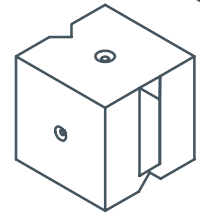

Vee FB-915

915mm x 610mm x 610mm
800kg
Artic Full Load 36 no.
Crane Offload 28 no.

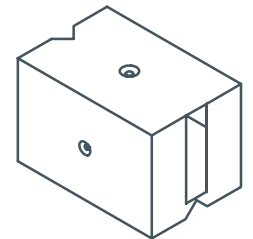

ELITE
PRECAST CONCRETE

For more information or technical advice, contact 01952 588885
or browse our products on www.eliteprecast.co.uk

Elite Precast Concrete

Vee™ interlocking blocks sheet 2

Vee FB-1220

1220mm x 610mm x 610mm
1067kg
Artic Full Load 26 no.
Crane Offload 21 no.

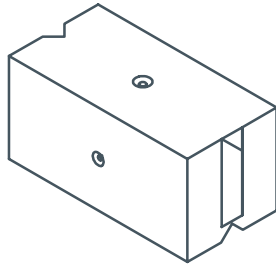

Vee FB-1525

1525mm x 610mm x 610mm
1333kg
Artic Full Load 21 no.
Crane Offload 17 no.

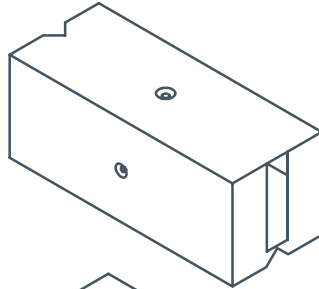

Vee FB-1830

1830mm x 610mm x 610mm
1600kg
Artic Full Load 18 no.
Crane Offload 14 no.

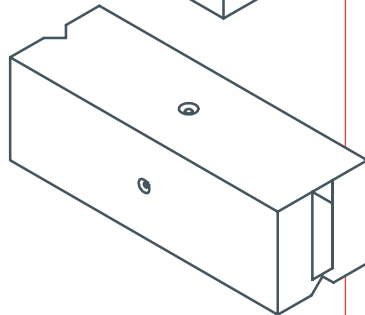

Vee HB-610

610mm x 610mm x 305mm
266kg
Artic Full Load 108 no.
Crane Offload 86 no.

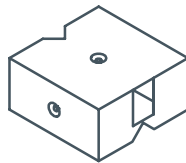

Vee HB-915

915mm x 610mm x 305mm
400kg
Artic Full Load 72 no.
Crane Offload 57 no.

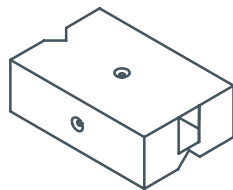

Vee HB-1220

1220mm x 610mm x 305mm
533kg
Artic Full Load 54 no.
Crane Offload 43 no.

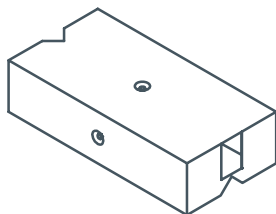

Vee HB-1525

1525mm x 610mm x 305mm
666kg
Artic Full Load 43 no.
Crane Offload 34 no.

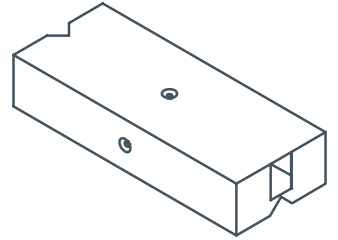

Vee HB-1830

1830mm x 610mm x 305mm
800kg
Artic Full Load 36 no.
Crane Offload 29 no.

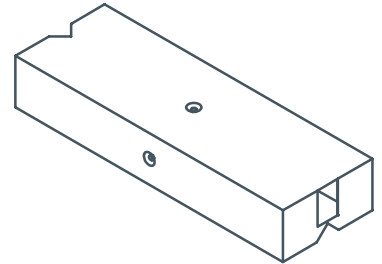

Vee C1-1525

1525mm x 610mm x 610mm
1333kg
Artic Full Load 21 no.
Crane Offload 17 no.

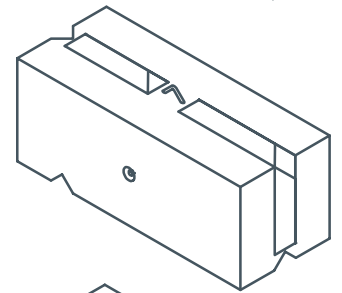

Vee C2-1525

1525mm x 610mm x 610mm
1333kg
Artic Full Load 21 no.
Crane Offload 17 no.

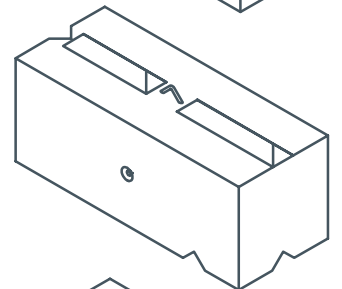

Vee T2-1525

1525mm x 610mm x 610mm
1333kg
Artic Full Load 21 no.
Crane Offload 17 no.

